

# 從此處開始

# Start Here

# 1

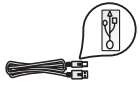

**USB 纜線使用者：** 在本指南指示您之前，請勿連接 USB 纜線，否則軟體可能無法正確安裝。

**USB cable users:** Do not connect the USB cable until this guide instructs you to or the software may not install properly.

請使用本指南設定硬體並連接 HP All-in-One 到您的電腦或網路。如果您在安裝時發生任何問題，請參閱本指南稍後的「疑難排解」。

Use this guide to set up the hardware and connect the HP All-in-One to either your computer or a working network. If you have problems during setup, see **Troubleshooting** later in the guide.

# 2

## 撕掉所有膠帶

## Remove all tape

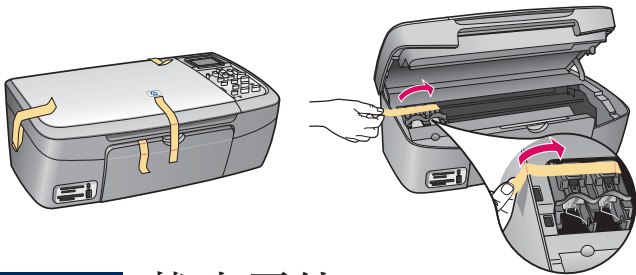

掀起檔門，然後撕掉裝置左邊的膠帶。

Lift the access door and remove tape on the left side of the device.

# 3

## 找出零件

## Locate components

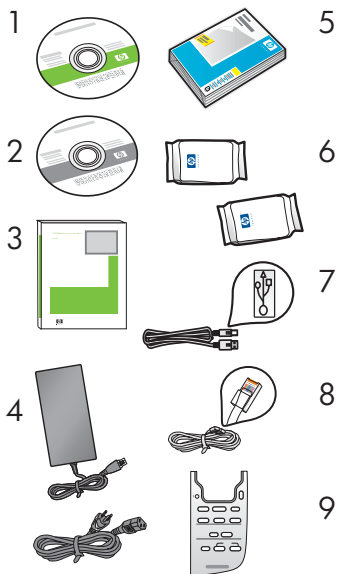

- 1 Windows CD
  - 2 Macintosh CD
  - 3 使用者指南
  - 4 電源線與電源轉接器
  - 5 4x6 英吋 (10x15 公分) 相片紙
  - 6 列印墨匣
  - 7 USB 纜線
  - 8 乙太網路纜線
  - 9 控制台面板 (可能已預先裝好)
- 包裝盒內容可能有所差異。本指南稍後會說明其他網路設備。

- 1 Windows CD
  - 2 Macintosh CD
  - 3 User Guide
  - 4 Power cord and adapter
  - 5 4x6 in (10x15 cm) photo paper
  - 6 print cartridges
  - 7 USB cable
  - 8 Ethernet cable
  - 9 Control panel faceplate (may be pre-attached)
- The contents of your box may differ. Additional network equipment specified later in guide.

# 4

裝上控制台面板（若尚未裝上）

Attach the control panel faceplate (if not attached)

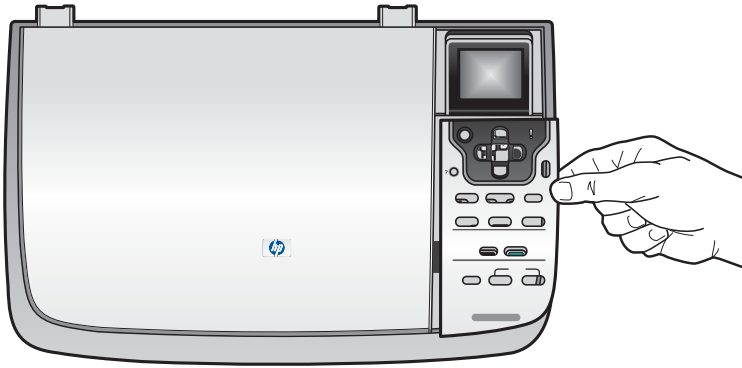

- a 將控制台面板置於裝置之上。
- b 在蓋片的所有邊緣上均勻用力按下以裝上它。

- a Position the control panel faceplate above the device.
- b Press down firmly on all edges of the overlay to secure it.

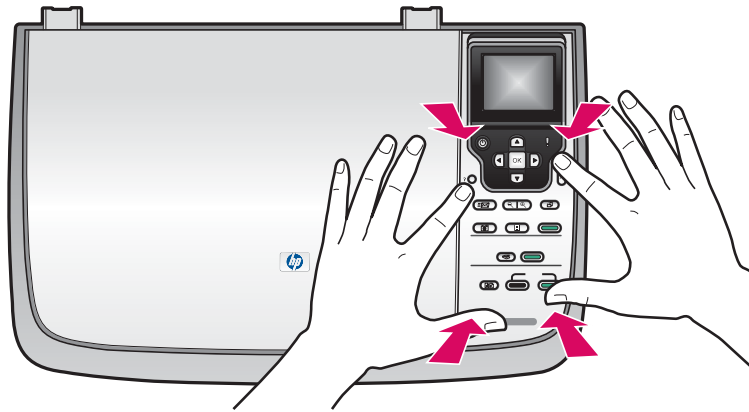

HP All-in-One 必須裝上控制台面板才能運作！

The control panel faceplate must be attached for the HP All-in-One to work!

# 5

掀起彩色圖形顯示器

Lift color graphics display



爲了獲得最佳檢視效果，請撕掉顯示器上的保護膜。

For best viewing, remove the protective film from the display.

# 6

放入普通白紙

Load plain white paper

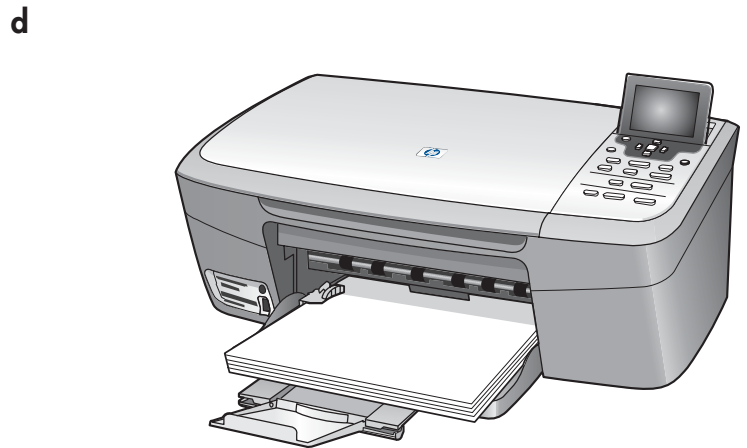
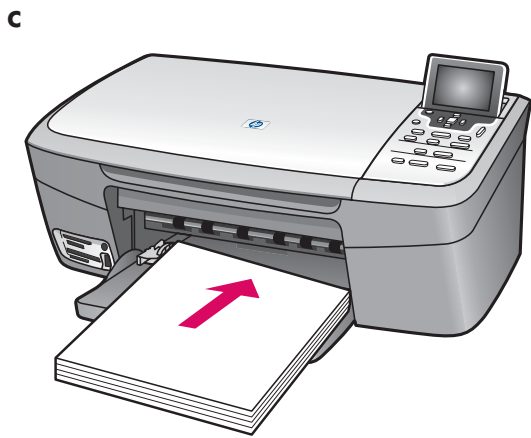
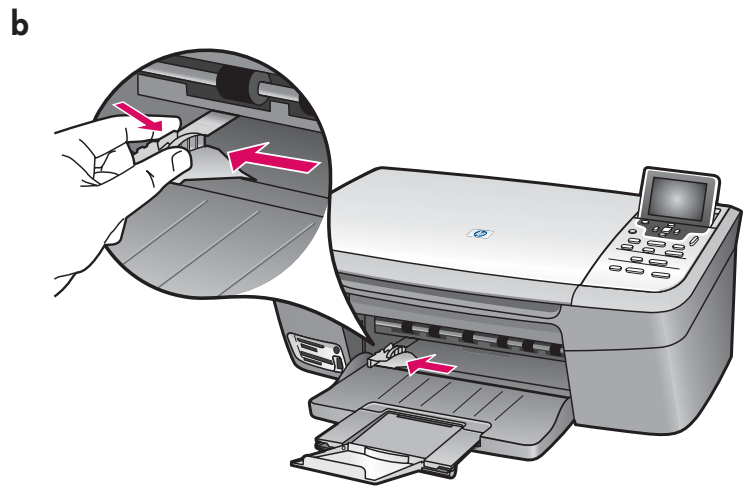
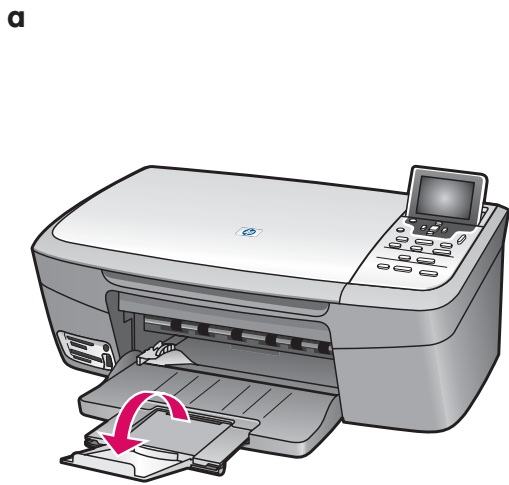

# 7

接上電源線

Connect the power cord

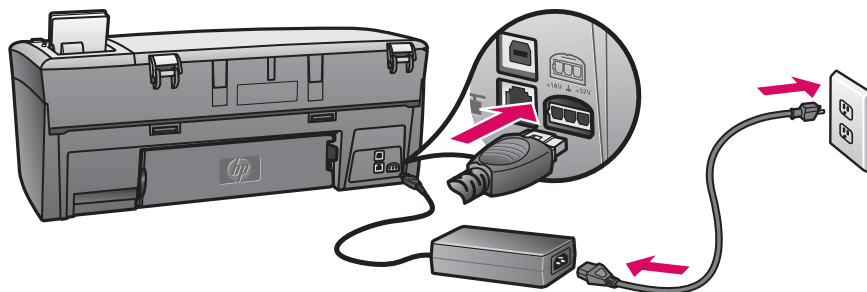

**USB 纜線使用者：** 在本指南稍後指示之前，不要連接 USB 纜線。

**USB cable users:** Do not connect the USB cable until instructed later in this guide.

# 8

## 按下「開啟」按鈕

### Press the On button

開啟  
/ On



- a 您按下「開啟」 按鈕之後，綠燈會閃爍，然後變成持續亮綠燈。此過程可能要花一分鐘的時間。
- b 請等候列印墨匣提示後再繼續。

- a After you press the **On**  button, the green light flashes, and then becomes solid. This may take up to a minute.
- b Wait for the print cartridge prompt before continuing.

# 9

## 開啟檔門

### Open the access door

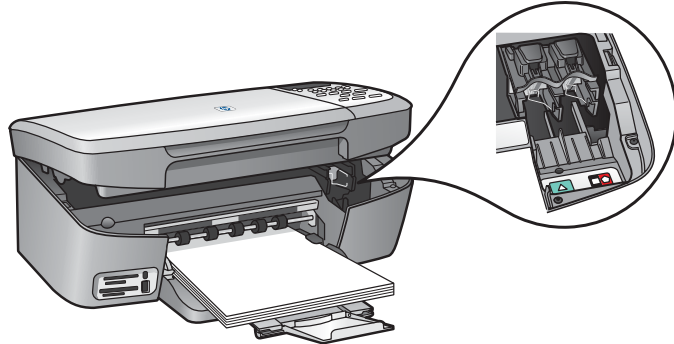

掀起檔門直到它停住為止。  
列印滑動架會移動到右側。

Lift the access door until it stops. The print carriage moves to the right.

# 10

## 撕掉兩個墨匣上的膠帶

### Remove tape from both cartridges

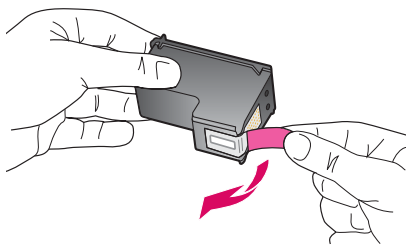

拉動粉紅色標籤以撕掉兩個列印墨匣的膠帶。

Pull the pink tab to remove the tape from **both** print cartridges.

請勿接觸銅色的接點或重新將膠帶貼回墨匣。

Do not touch the copper-colored contacts or retape the cartridges.

## Insert the tri-color print cartridge

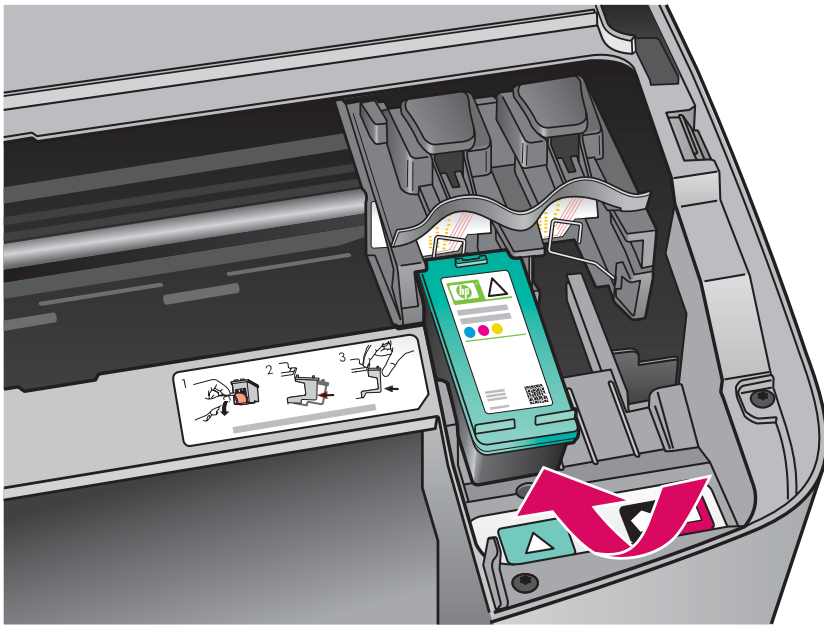

在插入列印墨匣之前，裝置必須在開啟狀態。  
當裝置開啓時，列印墨匣會在右側。

- 握住三色列印墨匣，讓 HP 標籤朝上。
- 將三色列印墨匣置入標示綠色標籤的左插槽前方。
- 穩當地將墨匣推進插槽中，直到它固定為止。

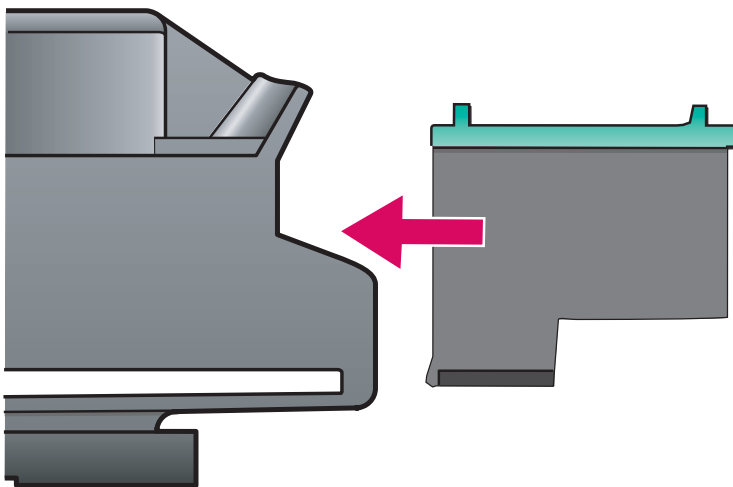

The device must be **On** before you can insert the print cartridges.  
When the device is on, the print carriage is on the right side.

- Hold the **tri-color** print cartridge with the HP label facing up.
- Place the **tri-color** print cartridge in front of the **left** slot marked with the green label.
- Push the cartridge firmly into the slot until it snaps into place.

## Insert the black print cartridge

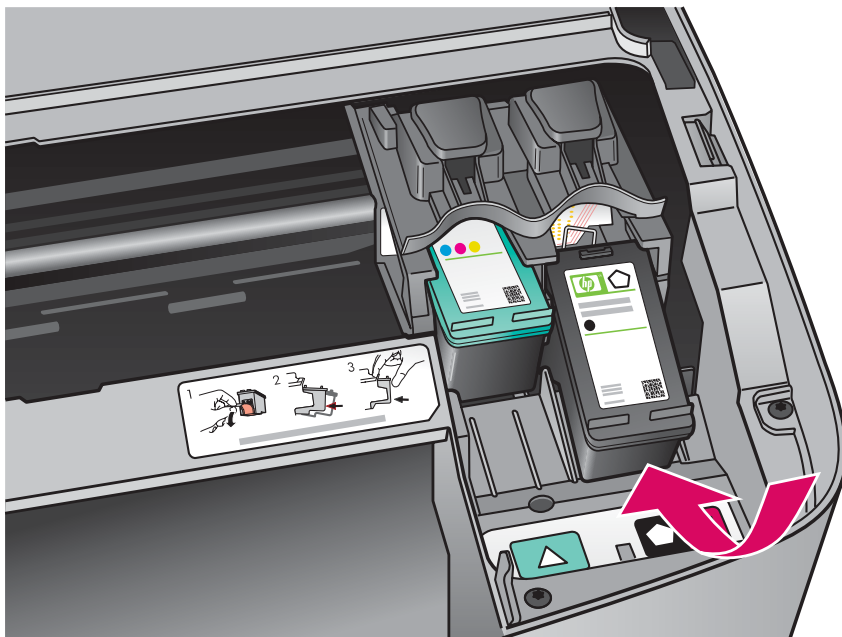

- a 握住黑色列印墨匣，讓 HP 標籤朝上。
- b 將黑色列印墨匣置入標示黑色和橘色標籤的右插槽前方。
- c 穩當地將墨匣推進插槽中，直到它固定為止。
- d 關閉墨水匣更換檔門。

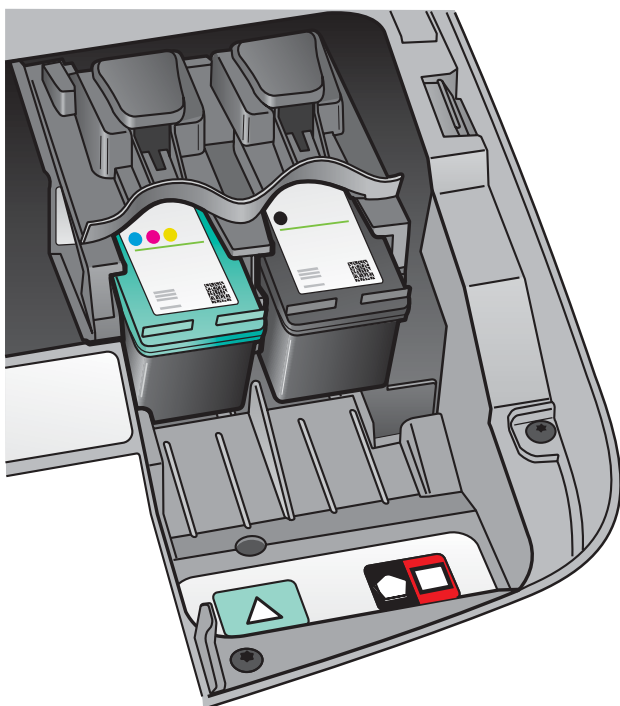

- a Hold the **black** print cartridge with the HP label facing up.
- b Place the **black** print cartridge in front of the **right** slot marked with the black and orange label.
- c Push the cartridge firmly into the slot until it snaps into place.
- d Close the access door.

# 13

## 校正列印墨匣

### Align the print cartridges



- a** 在控制台的每個提示中按「OK」以開始校正列印墨匣。校正過程可能會花幾分鐘的時間。
- b** 列印校正頁之後，校正就算完成。檢視彩色圖形顯示器以查看狀態，然後按「OK」。如果校正失敗，請使用普通白紙再試一次。請參閱《使用者指南》以獲得詳細資訊。回收或丟棄該校正頁。

- a** Press **OK** at each of the prompts on the control panel to start print cartridge alignment.  
The alignment may take a few minutes.
- b** After the page prints, alignment is complete. Check the color graphics display for the status, and then press **OK**. If it fails, try again with plain white paper. See the User Guide for more information.  
Recycle or discard the alignment page.

# 14

## 打開電腦的電源

### Turn on your computer



- a** 打開電腦的電源，必要時請登入，接著等候桌面出現。
- b** 關閉任何開啓的程式。

- a** Turn on your computer, login if necessary, and then wait for the desktop to appear.
- b** Close any open programs.

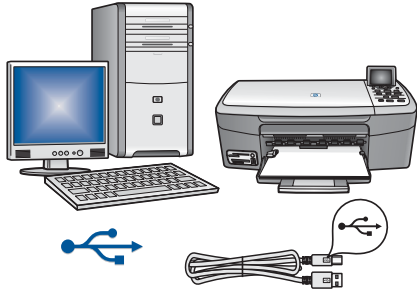
**A : USB 連線 - 請先不要連線****A: USB Connection - Do not connect yet**

如果您想要直接將裝置连接到一台電腦，請使用此連線類型。（在軟體指示您進行之前，請勿連接）。

需要的設備有：USB 纜線。

若使用 USB 連線，請參閱 A 部分的指示（第 9 頁）。

Use this connection type if you want to connect the device directly to one computer. **(Do not connect until the software instructs you to.)**

Equipment needed: USB cable.

**For a USB connection, go to Section A (page 9) for instructions.**

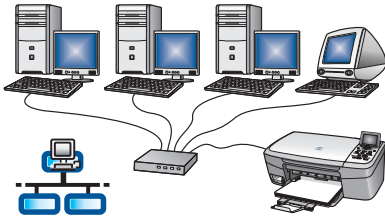
**B : 乙太 (有線) 網路****B: Ethernet (Wired) Network**

如果您想要在裝置和電腦之間使用乙太網路纜線連線，請使用此連線類型。

需要的設備有：集線器/路由器/交換機和乙太網路纜線。

若使用乙太網路纜線連線，請參閱 B 部分的指示（第 11 頁）。

Use this connection type if you want an Ethernet cable connection between the device and your network.

Equipment needed: hub/router/switch and Ethernet cable.

**For an Ethernet cable connection, go to Section B (page 11) for instructions.**

**問題：** 如需設定網路的資訊，請至 [www.hp.com/support](http://www.hp.com/support)，輸入 **Photosmart 2570**，然後搜尋 **Network Setup**（網路設定）。

**Questions:** For information on how to set up a network, go to [www.hp.com/support](http://www.hp.com/support), enter **Photosmart 2570**, and search for **Network Setup**.





# A 部分：USB 連線

## Section A: USB Connection

A1

### 選擇正確的 CD

### Choose the correct CD

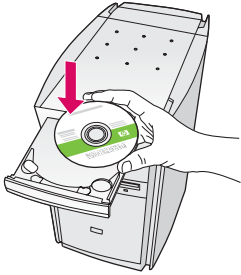

#### Windows 使用者：

#### Windows Users:

如果沒有顯示啓動畫面，請連接兩下「我的電腦」、連接兩下 **CD-ROM** 圖示，然後連接兩下 **setup.exe**。

If the startup screen does not appear, double-click **My Computer**, double-click the **CD-ROM** icon, and then double-click **setup.exe**.

#### Macintosh 使用者：

- a 找出 HP All-in-One **Macintosh** CD。
- b 繼續到下一頁。

#### Macintosh Users:

- a Locate the HP All-in-One **Macintosh** CD.
- b Continue to the next page.

- a 插入 HP All-in-One **Windows** CD。
- b 依照螢幕上的指示安裝軟體。
- c 在「連線類型」畫面，請確定選取「直接連接至此電腦」。繼續到下一頁。

- a Insert the HP All-in-One **Windows** CD.
- b Follow the onscreen instructions to install the software.
- c On the **Connection Type** screen, make sure to select **directly to this computer**. Continue to the next page.

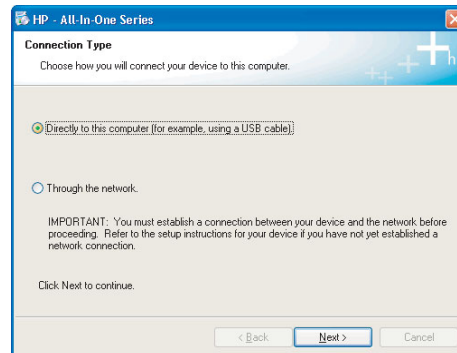

## Connect the USB cable

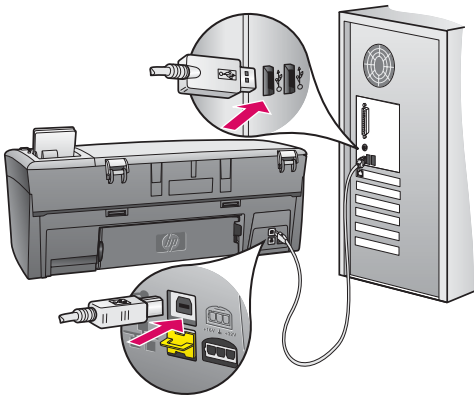
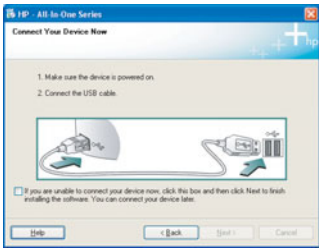

## Windows 使用者：

- a 依照螢幕上的指示進行，直到您看到提示連接 USB 纜線。  
(這可能會花幾分鐘的時間)。  
出現提示時，將 USB 纜線一頭連接到 HP All-in-One 後方的連接埠上，然後將另一頭連接到您電腦上的任何一個 **USB** 埠。
- b 依照螢幕上的指示進行。完成「立即註冊」畫面。

## Windows Users:

- a Follow the onscreen instructions until you see the prompt to connect the USB cable. (This may take several minutes.)  
Once the prompt appears, connect the USB cable to the port on the back of the HP All-in-One, and then to **any USB port** on your computer.
- b Follow the onscreen instructions. Complete the **Sign up now** screen.

## Macintosh 使用者：

- a 將 USB 纜線從電腦連接至裝置後方的 USB 埠。

## Macintosh Users:

- a Connect the USB cable from your computer to the USB port on the back of the device.

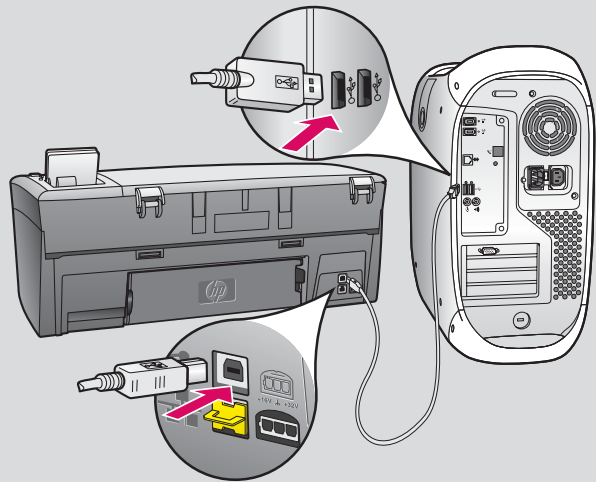

- b 連按兩下 **HP All-in-One Installer** 圖示。
- c 確定您完成所有畫面，包括「Setup Assistant (設定協助)」。

- b Double-click the **HP All-in-One Installer** icon.
- c Make sure you complete all screens, including the Setup Assistant.

## Go to back of the guide to make a test copy



## B 部分：乙太（有線）網路

### Section B: Ethernet (wired) network

B1

#### 連接乙太網路纜線

#### Connect the Ethernet cable

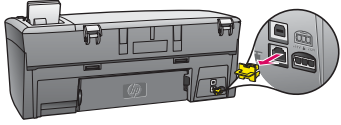

- 拿出裝置後面的黃色插栓。
- 將乙太網路纜線的一端連接到裝置後面的乙太網路連接埠。
- 將乙太網路纜線的另一端連接到集線器/路由器/交換機。如果纜線不夠長，可以購買較長的纜線。

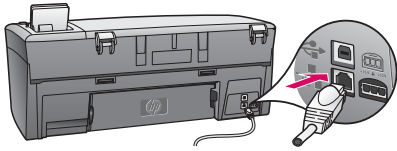

**重要：**請不要將乙太網路纜線連接到纜線數據機。您必須連上網路。如果您已經連接 USB 纜線，請不要連接乙太網路纜線。

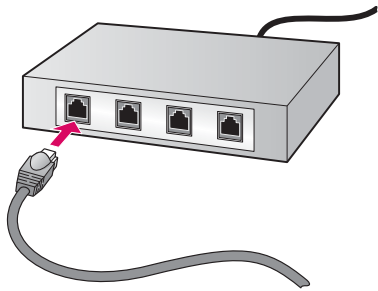

- Remove the yellow plug from the back of the device.
- Connect one end of the Ethernet cable to the Ethernet port on the back of the device.
- Connect the other end of the Ethernet cable to the hub/router/switch. If the cable is not long enough, you can purchase a longer cable.

**Important:** Do not connect the Ethernet cable to a cable modem. You must have a working network. If you already connected the USB cable, do not connect the Ethernet cable.

B2

#### 選擇正確的 CD

#### Choose the correct CD

**Windows 使用者：**

- 插入 HP All-in-One Windows CD。

**Windows Users:**

- Insert the HP All-in-One Windows CD.

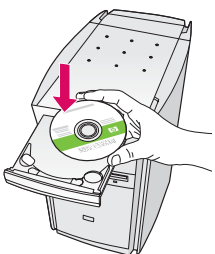

**Macintosh 使用者：**

- 插入 HP All-in-One Macintosh CD。

**Macintosh Users:**

- Insert the HP All-in-One Macintosh CD.

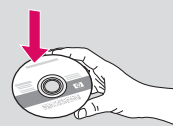

如果沒有顯示啟動畫面，請連接兩下「我的電腦」、連接兩下 **CD-ROM** 圖示，然後連接兩下 **setup.exe**。

If the startup screen does not appear, double-click **My Computer**, double-click the **CD-ROM** icon, and then double-click **setup.exe**.

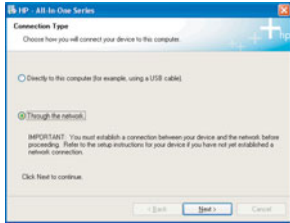

### Windows 使用者：

- b 依照螢幕上的指示安裝軟體。
- c 在「連線類型」畫面，請確定選取「透過網路」。依照螢幕上的指示進行。
- d 您必須在所有的軟體訊息出現時選擇 **unblock**（解除）或 **accept**（接受），否則安裝會失敗。依照所有螢幕上的指示進行。繼續到下一頁。

### Windows Users:

- b Follow the onscreen instructions to install the software.
- c On the **Connection Type** screen, make sure to select **through the network**. Follow the onscreen instructions.
- d You must choose **unblock** or **accept** on all firewall messages or setup will fail. Follow all onscreen instructions. Continue to the next page.

問題：防毒軟體或軟體程式可能會阻礙軟體安裝。如需詳細資訊，請至 [www.hp.com/support](http://www.hp.com/support)，輸入 **Photosmart 2570**，然後搜尋 **Firewalls**（防火牆）。

**Questions:** Anti-virus or firewall programs can block software installation. For details, go to [www.hp.com/support](http://www.hp.com/support), enter **Photosmart 2570**, and then search for **Firewalls**.

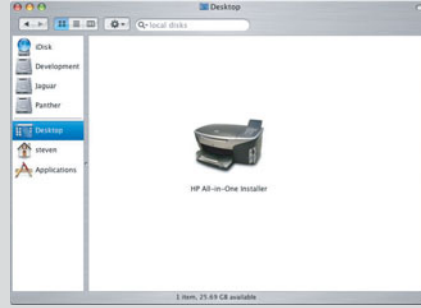

### Macintosh 使用者：

- b 連接兩下 **HP All-in-One Installer** 圖示。
  - c 確定您完成所有畫面，包括「Setup Assistant（設定協助）」。
- 繼續到下一頁。

### Macintosh Users:

- b Double-click the **HP All-in-One Installer** icon.
- c Make sure you complete all screens, including the Setup Assistant. Continue to the next page.



## B3

### 在其他電腦上安裝軟體

#### Install software on additional computers

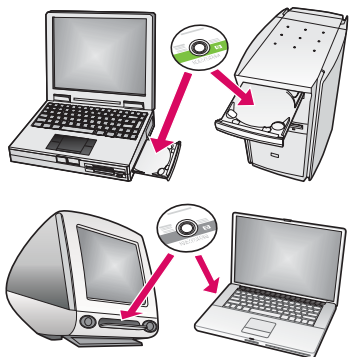

如果您的網路上有其他電腦，請在每一台電腦上安裝 HP All-in-One 軟體。每次安裝時請選擇正確的 HP All-in-One CD。

依照螢幕上的指示進行。請確定在網路和 HP All-in-One 之間（不是電腦和網路之間）選擇連線類型。

If you have additional computers on your network, install the HP All-in-One software on each computer. Choose the correct HP All-in-One CD for each installation.

Follow the onscreen instructions. Make sure that you choose the connection type between the network and your HP All-in-One (not between your computer and the network).

## B4

### 請參閱最後一頁影印一份測試頁

#### Go to the last page to make a test copy

## 疑難排解

## Troubleshooting

**問題：**出現「滑動架卡住」訊息。

**動作：**開啓檔門。清除裝置裡面的膠帶。將電源關閉，然後等候一分鐘。再開啓電源。



**Problem:** A **Carriage Jam** message appears.

**Action:** Open the access door. Remove the tape from inside the device. Turn the power off, and then wait one minute. Turn the power on again.

**問題：** 沒有看見螢幕提示您連接 USB 纜線。

**動作：** 拿出 HP All-in-One **Windows** CD，再重新插入。參閱 A 部分。



**Problem:** You did not see the screen prompting you to connect the USB cable.

**Action:** Remove, and then re-insert the HP All-in-One **Windows** CD. Refer to Section A.

**問題：** 出現「歡迎使用新增硬體精靈」畫面。

**動作：** 按一下「取消」。拔掉 USB 纜線，再插入 HP All-in-One **Windows** CD。參閱 A 部分。



**Problem:** The **Microsoft Add Hardware** screen appears.

**Action:** Click **Cancel**. Unplug the USB cable, and then insert the HP All-in-One **Windows** CD. Refer to Section A.

**問題：** 出現「裝置安裝無法順利完成」畫面。

**動作：** 檢查控制台面板是否有穩固裝好。拔下 HP All-in-One 的插頭，然後再將它插上。檢查所有連線。確定 USB 纜線已插到電腦。請勿將 USB 纜線插到鍵盤或是電源未開啓的集線器。參閱 A 部分。

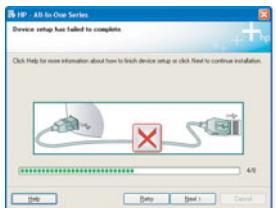

**Problem:** The **Device Setup Has Failed To Complete** screen appears.

**Action:** Verify that the control panel faceplate is firmly attached. Unplug the HP All-in-One and plug it in again. Check all connections. Make sure the USB cable is plugged into the computer. Do not plug the USB cable into a keyboard or non-powered hub. Refer to Section A.

## 列印一份測試頁

您現在已完成安裝，可以開始使用 HP All-in-One。列印一份最喜愛的相片。

a

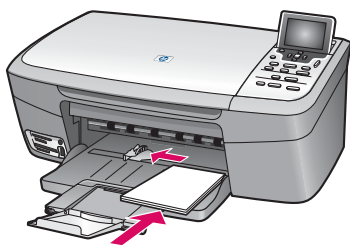

- a 拿出普通白紙，然後裝入 4 x 6 英吋（10x15 公分）的相片紙。將相片紙的光面朝下。將紙張調整器移動到紙疊的旁邊。

b



- b 找出 4x6 英吋（10x15 公分）的相片。

c



- c 將相片（面朝下）放置在玻璃板的右前方角落。確定相片的長邊沿著玻璃板的前方放好。關上蓋子。

d



- d 按下「開始影印 - 彩色」按鈕。

HP All-in-One 會影印一份原始相片。

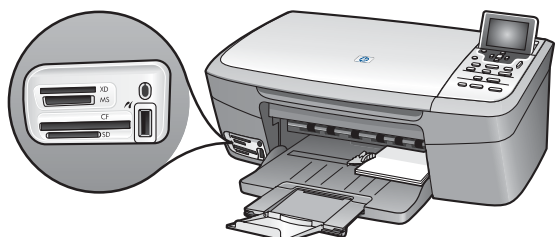

若要瞭解從記憶卡列印相片和其他功能，請參閱《使用者指南》和線上說明。如需其他說明，請瀏覽 [www.hp.com/support](http://www.hp.com/support)。



# Print a test copy



Q7211-90284

Now that you have finished setup, it is time to use your HP All-in-One. Make a copy of a favorite photo.

**a**

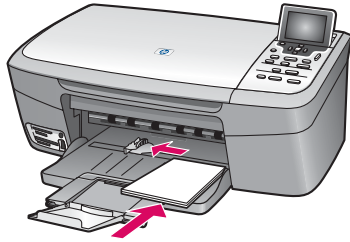

- a** Remove the plain white paper and load the 4 x 6 in (10x15 cm) photo paper. Place the paper glossy side down. Move the paper adjusters next to the stack of paper.

**b**



- b** Find a 4x6 in (10x15 cm) photo.

**c**



- c** Place the photo (face down) on the right front corner of the glass. Make sure the long edge of the photo is along the front of the glass. Close the lid.

**d**



- d** Press the **Start Copy Color** button.

The HP All-in-One makes a copy of your original photo.



To learn about printing photos from memory cards and other features, see the User Guide and online help. For additional help, see [www.hp.com/support](http://www.hp.com/support).

