

MFX-1200/1600

Plain-paper digital Fax/Copier/Printer

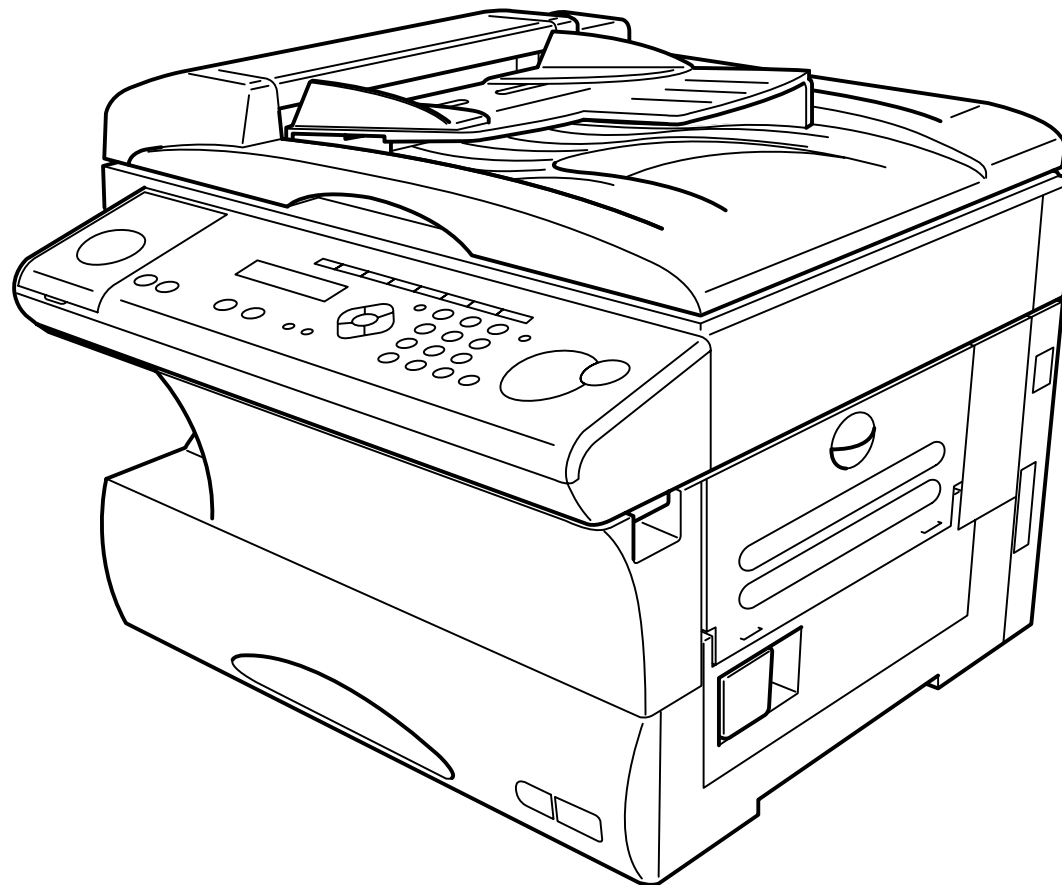

Operating Instructions

muratec[™]
The Fax Specialists.

MuratecTM

The Fax Specialists.

Muratec America, Inc.
6400 International Parkway
Suite 1500
Plano, Texas 75093
<http://www.muratec.com>



Welcome

Thank you!

Thanks for selecting a Muratec fax machine for your business.

Before you begin, please note that before your fax can be used and before you can turn on power to the unit for the first time, there are important precautions to take. Please see page 1.5 for more information.

muratec™

Trademarks

Muratec, the Muratec logo and all Muratec fax product names contained herein are trademarks of Muratec America, Inc.

ENERGY STAR is a registered mark of the United States Environmental Protection Agency.

Copyright

Copyright ' 2000 by Muratec America, Inc. All rights reserved.



As an Energy Star[®] partner, Muratec America, Inc., has determined that this product meets the Energy Star guidelines for energy efficiency.

Energy saving

Your machine can save the energy with its Energy Saving Mode.

In the Energy Saving Mode the printer will not use its fusing lamp and Energy Save Mode will be displayed on the LCD. If your machine receives a fax message or if any key is pressed your machine will automatically wake up.

The time for the machine to enter the Energy saving mode can be selected from 1 to 120 minutes. For details, see Setting sleep mode, page 4.10.



Super G3 is an extension of Group 3 fax technology standards, allowing the use of high-speed ITU-T V.34 bis modems for 33.6 Kbps transmission and high-speed protocols for rapid handshaking.

JBIG Joint Bi-level Image experts Group, the new ITU-T standard image data compression method. As JBIG compresses the data more efficiently than MMR, it is especially effective when transmitting halftone (grayscale) image document.

Note: Super G3 and JBIG are available only for MFX-1600.

This manual and any updates to it can be found online at www.muratec.com

Go to the Products section of this site, then click on *MFX-1200/1600*

Before using your Muratec fax machine

Where to set up your fax machine

Follow these guidelines when setting up your fax machine:

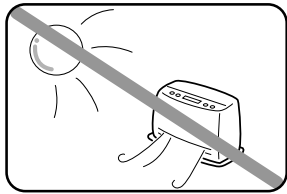

Away from direct sunlight

To avoid overheating, set up your fax machine away from direct sunlight or a heater.

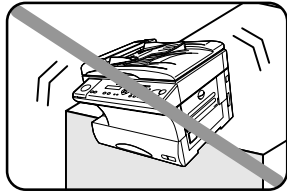

Level, and vibration-free

To avoid damage to the machine or injuries, set the fax machine up in a level, vibration-free location.

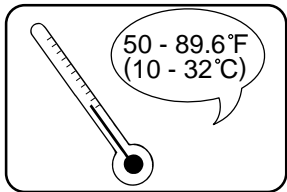

Avoid extreme high / low temperature

Use your fax machine within the temperature range of 50° F to 89.6° F (10° C to 32° C).

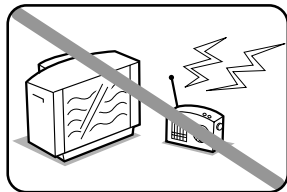

Away from a television or radio

Many appliances and office equipment, including televisions, radios, copy machines, air conditioners and computers, can generate electronic noise that can interfere with the operation of your fax machine.

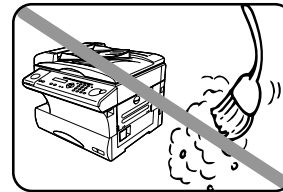

Clean

Dust buildup can damage your fax. Periodically clean your fax machine as described in the operating instructions. **Do not use a dust cover**, which can cause damaging overheating.

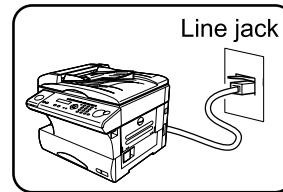

Near a phone jack

Your fax machine uses a standard (modular) telephone jack, also known as an RJ-11.

Space around the fax machine

To ensure proper ventilation and easy operation, set up the machine in an area that meets the minimum requirements for clearance as illustrated below.

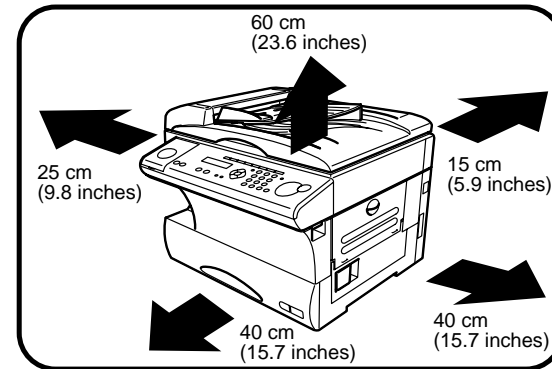

Power requirements

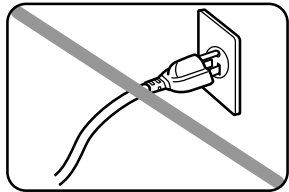

Plug in the power cord

Plug the power cord carefully and completely into a wall outlet. Do not leave any portion of the electrical cord's metal prongs exposed. Doing so could cause a fire and poses a risk of electrical shock.

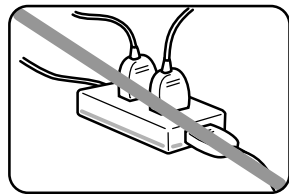

Do not share an extension cord connector with other plugs

It can cause electrical shock.

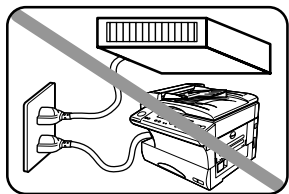

Do not share an outlet with a large appliance

High-consumption appliances such as a refrigerator or air conditioner can cause draw-downs which could damage your fax machine.

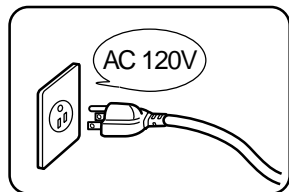

120 VAC outlet

Use a standard three-pronged 120 V electrical outlet to power your fax machine. Using any other electrical outlet will cause damage to your fax.

For domestic use only

Never use your fax machine outside the country in which you purchased it. Doing so may violate telecommunication and safety regulations of that country, and variations in electrical and telephone standards can cause poor performance and damage to your fax.

General Precautions

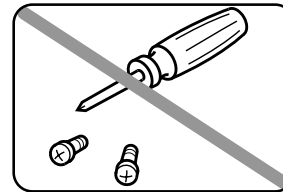

Never disassemble your fax machine!

Disassembling your fax machine can cause serious injury to you and damage to your fax. If service is required, call your authorized Muratec dealer.

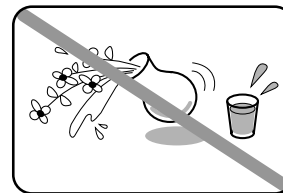

Keep away from liquids

Keep liquids and metal pins or other objects away from your fax machine. If something falls into the fax machine, remove the plug from the outlet, and call your authorized Muratec dealer.

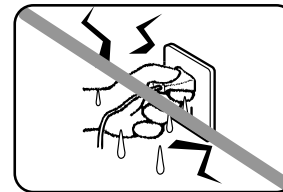

Never handle your fax machine or power cord with wet hands

Never touch your fax machine or power cord if your hands are wet.

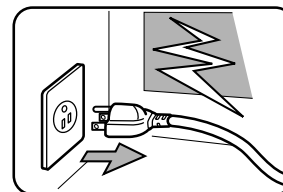

During electrical storms, disconnect the plug from the outlet

Electrical storms can cause electrical shock or damage to the fax machine.

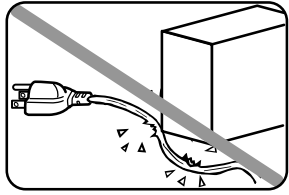

Do not put furniture or equipment on the power cord

Do not put anything on or over the electrical power cord, and do not route the power cord under rugs or carpets. Doing so can damage the power cord or fax, and can cause fire or electrical shock.

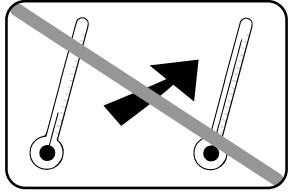

Avoid temperature fluctuations

Sudden changes in temperature can cause damaging condensation to form inside your fax machine.

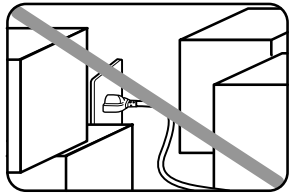

Allow clearance around the outlet

Don't stack boxes or furniture around the outlet.

Use caution when carrying the fax

Lift and carry the fax machine as described in your operating instructions. Some fax machines require two people to safely and properly carry.

Use supplies manufactured specifically for Muratec fax machines

Using toner cartridges and other supplies that are not manufactured specifically for Muratec machines may affect the operation of your unit.

Storing and handling toner and drum cartridges

To avoid damage to your fax machine and to assure the best performance possible, follow these guidelines when storing and handling toner and drum cartridges:

Store the cartridge

Store the cartridge at a constant temperature within a range of 32° F to 95° F (0° C to 35° C). To avoid dew do not store cartridges in locations subject to extreme fluctuation of temperature and humidity.

Do not stand the cartridge on its end and do not store it upside down.

Do not open the protective bag of the cartridge until you are ready to install the cartridge.

Do not store cartridges in areas of:

- Direct sunlight
- Dusty conditions
- Near floppy disks or other computer media, computer screens, or any other materials sensitive to magnetic fields.

DO NOT BURN TONER CARTRIDGES!

The toner powder is extremely flammable. Exposure to flame can cause toner cartridges to burn or explode, causing serious injury.

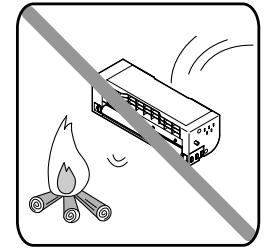

Be careful not to get the toner powder in your eyes.

If the toner powder gets in your eyes, wash your eyes well and see a doctor.

Keep cartridges away from water or oil.

Do not expose cartridges to direct sunlight.

Do not expose the cartridges to static or other electrical shock.

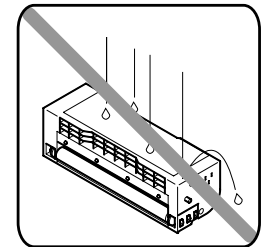

This page intentionally blank.

Welcome to your Muratec fax machine!

These instructions are divided into the following sections.

Getting started (page 1.1) describes how to set up your machine, operating tips and some important settings that you should perform before you use your machine.

Basic operations (page 2.1) describes the basic operations of the transmission, reception and copying.

Advanced features (page 3.1) describes the convenient features of your machine.

Changing the default settings (page 4.1) describes how to change the settings of your machine.

Finally, **Just in case** (page 5.1) helps you if you ever have a problem with your machine. It also tells you how to give your machine the kind of easy, sensible care that should keep troubles to a minimum.

Thanks for choosing Muratec.

Find your serial number and write it down

Please note that your machine's *serial number* is located on the *bar code label* as shown on the drawing at right. Use the blank at the bottom of this column to copy this down *before* you set up your machine.

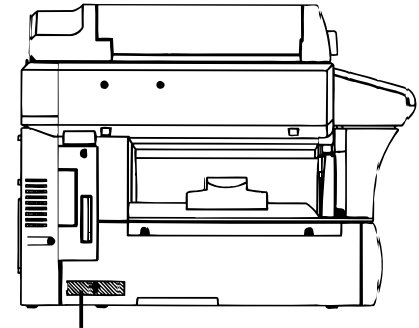

Bar code label

Close up, the bar code label looks something like this, but with a different set of numbers:



Please copy down your machine's serial number below for future reference, and note the machine's model number:

My machine's serial number: _____

My machine's model number: □ Muratec MFX-1200
□ Muratec MFX-1600

Table of Contents

Getting started	
Packaging contents	1.1
Parts of your machine	1.1
Control Panel Overview	1.3
Setting up	1.5
Pick an installation spot	1.5
Power tips	1.5
Unlocking the mirror carriage	1.5
Installing the printing supplies	1.6
Attach the paper-handling parts	1.7
Plug in and power up	1.7
Turning off the transport mode	1.8
Adjust the monitor speaker's volume	1.8
Loading paper	1.8
Operating tips	1.11
Changing modes	1.11
Turning off the power	1.11
How to operate the machine	1.11
Entering characters	1.12
Searching the functions using the cursor key	1.13
Function table	1.14
EasyStart (Initial settings)	1.18
Getting started	1.18
Clearing stored settings	1.18
Entering initial settings	1.18
Basic Operations	
Sending faxes	2.1
Guidelines	2.1
Memory transmission	2.3
Memory overflow message	2.3
Quick memory transmission	2.3
Real time transmission (Non-memory transmission)	2.3
Sending a fax using the ADF	2.4
Sending a fax using the FBS glass	2.5
Sending a fax using monitor/call key or a handset	2.6
Redialing	2.7
Reviewing or canceling commands	2.8
Printing a delayed command list	2.9
Printing a stored document	2.9
Receiving faxes	2.10
Answering calls manually	2.10
Reception modes	2.10
How to select the fax reception mode:	2.11
If the paper runs out while fax reception	2.11
Making copies	2.12
Your machine's copier features	2.12
Basic copy procedure	2.12
Single copy	2.12
Stacking multiple copies	2.13
Sorting multiple copies (using ADF)	2.13
Enlarged or reduced copies	2.13
Using the bypass tray	2.14
Memory overflow message	2.14
If the paper runs out while copying	2.14
Making copy settings	2.15
Special copy function	2.16
Copy protection	2.18
Using your fax machine as a phone	2.19
Dialing a telephone number	2.19
On-hook dialing	2.19
Redial	2.19
Call request	2.19
Changing the dialing type	2.19
Dialing in the event of a power failure	2.19
Attaching an optional handset	2.20
Attaching a second phone	2.20
Advanced Features	
Autodialer	3.1
Autodialer basics	3.1
Using one-touch keys	3.2
Using speed-dial numbers	3.5
Call group dialing	3.8
EasyDial directory dialing	3.9
Broadcasting	3.10
Making changes to broadcasts	3.10
Delayed transmission	3.11
Setting up a delayed transmission	3.11

Batch transmission	3.12	Changing redial settings	4.5
Creating or modifying a batch box	3.12	Settings for copying	4.6
Printing a list of batch boxes	3.13	Copy scan settings	4.6
Storing a document for batch transmission	3.13	Adjusting the copy print settings	4.6
Printing a list of stored batch documents	3.13	Changing the copy auto reset time	4.7
Printing a document stored in a batch box	3.13	Setting copy auto	4.7
Erasing a document stored in a batch box	3.14	Setting Negative/Positive	4.7
Erasing an empty batch box	3.14	Setting combine	4.7
Polling	3.15	Settings for operation	4.8
Regular polling	3.15	Setting the silent mode	4.8
Being polled	3.15	Primary mode	4.9
Printing a stored polling document	3.15	Printing your settings	4.10
Erasing a stored polling document	3.15	Printer options	4.11
Limiting polling access to your fax machine	3.15	Print the Demo Page	4.11
Special features	3.17	Print the Printer Configuration Page	4.11
Soft keys	3.17	Print PCL Font List	4.11
Macro keys	3.18	Print NIC status	4.11
Fax & Copy	3.21	Set TCP/IP Address	4.11
Setting the activity journal	3.21		
Setting the reports: TCRS and RCRS	3.22	Just in case	
Cover page	3.23	Clearing paper jams	5.1
OneLine + distinctive ring detection	3.24	If an original document jams	5.1
Call request	3.25	If a printout jams inside your machine	5.2
The power of QuadAccess [®]	3.26	Print quality problems	5.3
F-Code Boxes	3.26	Troubleshooting	5.5
Programmable one-touch keys	3.36	Errors	5.9
Security features	3.50	Caring for your fax machine	5.12
The passcode	3.50	Corrective cleaning	5.12
Security reception	3.50	If you have unsatisfactory printout quality	5.13
Masking the PIN	3.52	Common questions	5.14
Setting Block Junk Fax	3.54	General questions	5.14
Using department codes	3.56	Sending faxes	5.14
		We re here to help you!	5.14
Changing the default settings		Receiving faxes	5.16
Settings for transmission	4.1	Polling	5.16
Scan settings	4.1	Glossary	5.17
Memory transmission	4.2		
Quick Memory transmission	4.2	Appendix and index	
TTI transmission	4.2	Specifications	AI.1
Settings for reception	4.3	Regulatory information	AI.3
Print settings	4.3	Limited warranty	AI.4
Setting the number of rings	4.4	Index	AI.5
Image Rotation	4.4		
Settings for dialing	4.5		
Changing the dialing pause length	4.5		

Function table

Level one function	Level two function	Level three function	Summary of setting	Default setting	Page
A. Autodial Entries	1.One-touch Dial	01.Enter One-Touch (Max. 55 locations.)	Select one-touch key and register the fax dial numbers and names, also group numbers on one-touch dial keys. If you register the name, you can use the telephone index feature. If you register the group number, you can use the group dialing.		3.2
		02.Erase One-Touch	Erase the registration in a one-touch key.		3.3
	2.Speed Dial	01.Enter Speed-Dial (Max. 145 locations.)	Select speed-dial number and register the fax dial numbers and names, also group numbers as Speed-Dial numbers. If you register the name, you can use the telephone index feature. If you register the group number, you can use the group dialing.		3.5
		02.Erase Speed-Dial	Erase the registration in a speed-dial number.		3.6
	3.Program One-Touch	01.Enter P One-Touch	Program several operations for a function you frequently use. This key can reduce several steps to a simple press of a key.		3.36
		02.Erase P One-Touch	Erase the programming in a programmable one-touch key.		3.49
B. User Settings	1.Machine Settings	01.Cassette Size	Select the size of paper in the paper cassette.	Letter	1.9
		02.Protect Passcode	Enter the protection passcode for using the security features.		3.50
		03.Soft Key	Program to turn on or off any functions with just pressing this key.	Report Memory Tx Monitor/Call	3.17
		04.Silent Mode	Mute your machine.	Off	4.8
		05.Sleep Mode	Conserve power.	On (30 min.)	4.9
		06.Fax & Copy	Make a copy of your document each time it transmit.	Off	3.21
		07.Primary Mode	Determine the primary mode, Fax mode or Copy mode.	None	4.9
		08.Service Mode	For technical support. Do not set this setting to on unless an authorized technician asks you to do so.	Off	
		09.2-Bin Tray* ¹	Select the paper tray for delivery. Copy exit Received fax document exit List exit PC-Fax print exit* ²	Lower tray Upper tray Upper tray Upper tray	4.9
	2.Fax Settings	01.Scan Parameters	You can set the following settings for send fax message. Primary resolution mode Primary contrast mode	Normal Normal	4.1
		02.Print Parameter	You can set the following settings for receive fax message. Reduction rate Reduction margin Half-page reception	Auto 40 mm Off	4.3

*1: This option appears only if the optional 2-Bin tray has been installed.

*2: This option appears only if the optional RS-232C interface has been installed.

Level one function	Level two function	Level three function	Summary of setting	Default setting	Page	
B. User Settings	2.Fax Settings	03.# of Rings	Number of rings before your machine answers.	Two times	4.4	
		04.Redial	Number of times and interval for automatic fax redialing.	Two times One minute	4.5	
		05.Dialing Pause	Dialing pause length.	Two times	4.5	
		06.Memory Tx	On/Off setting for Memory transmission.	On	4.2	
		07.Quick Memory Tx	On/Off setting for Quick Memory transmission.	On	4.2	
		08.TTI Tx	On/Off setting for sending your TTI.	On	4.2	
		09.ECM Mode	On/Off setting for ECM mode.	On	4.1	
		10.Block Junk Fax	Reject the fax reception from unauthorized incoming faxes.	Off	3.54	
		11.Security Rx	Keep all received fax messages in memory and after print them.	Off	3.50	
		12.PIN Mode	Prevent unauthorized long-distance calls.	Off	3.52	
		13.Passcode	Enter passcode for limiting polling access.		3.16	
		14.Rotate Rx (for MFX-1600 only)	On/Off setting for Rotate Rx.	Off	4.4	
		14.DRD (for MFX-1200) 15.DRD (for MFX-1600)	Set the ring pattern to use with phone company s Distinctive Ring service.	Off	3.24	
		3.Copy Settings	01.Scan Parameters	You can set the following settings for copying. Primary document type Primary contrast mode	Text Normal	4.6
	02. Print parameter		You can set the margin for copying.	24 mm	4.6	
	03.Auto Reset Time		Set the time (minutes) of resetting the copy parameters.	3 minutes	4.7	
	04.Copy Auto		Set the default setting to Auto for one of the following: Paper size Reduce/Enlarge ratio Document size	Paper size	4.7	
	05.Copy Protect		On/Off setting for Copy protection.	Off	2.18	
	06.Sort Copy		On/Off setting for Sorting copy	On	2.16	
	07.Nega/Posi		On/Off setting to reverse copy of black and white areas.	Off	2.16, 4.7	
	08.Combine (for MFX-1600 only)		On/Off setting to combine.	Off	2.17, 4.7	
	4.Printer Settings	01.TCP/IP* ³	Enter the IP Address, Subnet mask and Gate way address.		4.11	
	C. Other Settings	1.Journal & Reports	01.Journal Auto Print	Print the Activity journal automatically after 100 transactions.	Off	3.21
			02.Journal Line Up	Change the printing order of the activity journal.	Off	3.22
			03.Set Report Type	Select TCR (Transmit Confirmation Report) or RCR (Receive Confirmation Report).	TCR	3.22
		2.Cover Page	01.Set Cover Page	On/Off setting for sending the Cover page.	Off	3.23
			02.Enter Cover Page	Enter your message for the cover page.		3.24

*3: This option appears only if the optional NIC (network interface card) has been installed.

Getting started

Level one function	Level two function	Level three function	Summary of setting	Default setting	Page
C. Other Settings	3.Department Code	01.Set Dept. Protect	Protection for department code settings.	Off	3.57
		02.Set Dept. Code	Register the Department code.		3.56
		03.Set Dept. Setting	On/Off setting for Department code activation.	Off	3.56
		04.Erase Dp.TimeList	Clear the total counts of each department code.		3.57
	4.F-Code Box	01.Set F-Code Box	Create the F-Code box.		3.26
		02.Erase F-Code Box	Erase an empty F-Code box.		3.33
	5.Batch Tx	01.Set Batch Box	Create the Batch box.		3.12
		02.Erase Batch Box	Erase an empty batch box.		3.14
D. Doc. Management	1.Store Document	01.Polling Document	Store the document to be retrieved by other fax machine.		3.15
		02.F-Code Document	Store the document to be retrieved by other F-Code compatible fax machine.		3.30
	2.Erase Document	01.Polling Document	Erase stored document for polling transmission.		3.15
		02.F-Code Document	Erase stored document in the F-Code box.		3.32
		03.Batch Document	Erase stored document in the Batch box.		3.14
	3.Document Print	01.Polling Document	Print the stored document for polling transmission.		3.15
		02.F-Code Document	Print the stored document in the F-Code box.		3.30
		03.Batch Document	Print the stored document in the Batch box.		3.13
		04.Security Rx Doc.	Print the fax received document during Security reception (and return to your machine to normal reception mode until the next time).		3.51
		05.Com. Stored Doc.	Print the stored document for delayed transmission.		2.9
E. Print	1.List Print	01.Machine Settings	Print a list of your machine settings.		4.10
		02.Fax Settings	Print a list of the fax settings.		4.10
		03.Copy Settings	Print a list of the copy settings.		4.10
		04.Journal	Print the activity journal manually.		3.22
		05.Commands List	Print a list of the delayed commands.		2.9
		06.One-Touch List	Print a list of the one-touch dial keys.		3.3
		07.Speed-Dial List	Print a list of the speed-dial numbers.		3.6
		08.P One-Touch List	Print a list of the programmable one-touch keys.		3.49
		09.Group List	Print a list of the group numbers.		3.8
		10.Block Junk Dial List	Print a list of the blocked numbers.		3.55
		11.Cover Page	Print a cover page.		3.24
		12.Depart. Time List	Print a total communication time and printed pages of each department code.		3.57
		13.F-Code Box List	Print a list of F-Code boxes.		3.20
		14.F-Code Doc. List	Print a list of the document stored in the F-Code boxes.		3.20

Level one function	Level two function	Level three function	Summary of setting	Default setting	Page
E.Print	1.List Print	15.Batch Box List	Print a list of Batch boxes.		3.13
		16.Batch Doc. List	Print a list of the document stored in the batch boxes.		3.13
		17.Macros List	Print a list of Macro keys.		3.20
	2.Printer Functions	01.Demo Page* ⁴	Print the highlight features and functions of the printer.		4.11
		02.Status Page* ⁴	Print all the status and configuration of the printer.		4.11
		03.Font List* ⁴	Print the list of all PCL fonts currently installed in the printer.		4.11
		04.NIC Status* ⁵	Print the NIC (network interface card) settings.		4.11
F. PC-FAX Commands* ⁶	1.PC-FAX	01.PC-FAX Scan	Scanning a document into the PC.		
		02.PC-FAX Initial	Initializing your machine.		
		03.Set RS-232C	Setting of the RS-232C parameters.		
I. User Install			Set-up the following settings: Language on the LCD and Lists Current Day and Time Automatically Daylight saving time Your TTI (your name) Subscriber ID (your fax number) Phone dialing type Fax reception mode	English Off Tone Fax Ready	1.18

*4:These option appears only if the optional printer controller has been installed.

*5: This option appears only if the optional NIC (network interface card) has been installed.

*6: This option appears only if the optional RS-232C interface has been installed. For details see the operating instructions that is included with the optional RS-232C kit.

EasyStart (Initial settings)

EasyStart software is already installed on your Muratec fax machine. It guides you through the process of entering your machine's settings. These settings you make here can always be changed later.

Getting started

Determine the following before you go any further:

- 1 The type of dialing** your telephone system requires. Choose either *tone* or *pulse* (rotary) dialing.
- 2 The name and fax number you want to appear on your faxes**. Every fax page you send arrives at the receiving machine with a single line of text at the very top of the page. This text lists a *name*, called the *Transmit Terminal Identifier (TTI)*, and a *fax number*. The TTI cannot be longer than 22 characters.

Clearing stored settings

Before using EasyStart, clear your machine's built-in *user data memory*. This ensures the memory will hold only *your* settings.

Important: After you use EasyStart, *do not* clear the memory again unless an authorized technician asks you to do so.

To clear the machine's memory:

- 1** Press **Program key**, *****, **2**. The LCD now asks if you want to clear the memory:

```
Clear User Settings
Check Enter/Cancel
```

Note: If you *don't* want to clear the memory, just press **CANCEL**.

- 2** If you *do* want to clear the memory, press **ENTER**.

Entering initial settings

Important: If you press **STOP** during EasyStart, your fax machine returns to *standby mode* (its normal condition). But it will keep the settings you saved by pressing **ENTER** as described in these instructions.

- 1** Press **Program key**, **1**, **ENTER**.
The LCD shows the current language setting.

```
Language :English
← / → / Enter
```

- 2** Press **◀** or **▶** until the language you want appears.
- 3** Press **ENTER** to save the setting and continue EasyStart.

- 4** The LCD now shows the current calendar/clock setting, with a *cursor* appearing under the first digit.

```
Enter Time
_01/01 01 00:00
```

- 5** Use the numeric keypad to enter the *correct date and time*, using a *MMDDYY* format for the *date* and *24-hour* format for the *time*. For instance, to set 8:30 PM on June 11, 2000, press **0611002030**, which results in:

```
Enter Time
_06/11 00 20:30
```

Note: Your fax machine automatically inserts the spaces and date-slash. All you have to do is enter the digits.

To change a digit, press **◀** to move the cursor left, or **▶** to move it right. Then enter the correct digit.

- 6** Press **ENTER** to save the clock setting and continue.

- 7** The LCD now asks if you want to set the calendar/clock to automatically recognize daylight saving time (DST).

```
Daylight Saving :Off
←/→/Enter
```

When the setting is *On*, your machine automatically recognizes DST at 2 AM on the appropriate switchover Sundays each year.
When the setting is *Off*, no automatic change will occur.

- 8** Press ◀ or ▶ until the mode you want appears.
Here, we've changed the setting to *On*:

```
Daylight Saving :On
←/→/Enter
```

- 9** Press ENTER to save the setting and continue.

- 10** The LCD now asks you to enter your fax number as you want it to appear on other fax machines' displays or printouts. The fax industry term for this number is *Subscriber ID*.

```
Your Fax Number
_
```

- 11** Use the numeric keypad to enter the fax number. To insert a dash, as shown here, press **DIALING OPTIONS** once. The number may contain up to 20 characters (numbers and dashes).

```
Your Fax Number
972-555-5525_
```

Note: If you make a mistake, press **CANCEL** to erase to the left.
To change just one number, press ◀ to move left, or ▶ to move right.
Press **CANCEL** to erase the number. Then re-enter the fax number correctly.

- 12** Press ENTER to save the number.

- 13** The LCD now asks you to enter the name you want to appear at the top of faxes you send. The name may be up to 22 characters in length.

Use the one-touch keys to enter letters and other non-numeric characters. (Refer to *Entering characters* on page 1.12.)

```
Your Name ;Upper
_
```

- 14** Press ENTER to save the setting and continue.

- 15** The LCD now asks you to enter the type of dialing needed for the fax machine, either *tone* or *pulse*:

```
Phone Type :Tone
←/→/Enter
```

- 16** Press ◀ or ▶ until the mode you want appears.
Here, we've changed the setting to *Pulse* mode:

```
Phone Type :Pulse
←/→/Enter
```

- 17** Press ENTER to save the setting and continue.

- 18** The LCD now shows the machine's current reception mode.

```
Fax Ready
←/→/Enter
```

- 19** For now, press ◀ or ▶ until the setting *Fax Ready* appears. (This setting can always be changed. We'll discuss reception modes further on pages 2.10-2.11.)

- 20** Press ENTER to save the setting. Your machine will return to standby mode.

Basic Operations

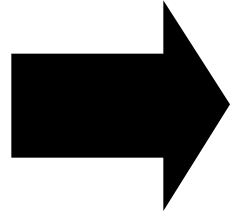

This chapter describes the basic operation of the transmission, reception and copying

Sending faxes	2.1
Receiving faxes	2.10
Making copies	2.12
Using your fax machine as a phone	2.19

Sending faxes

Guidelines

You can send a fax message using the ADF (Automatic Document Feeder) or FBS (Flatbed Scanner) glass. Before you begin the fax sending, please read the following guidelines.

Acceptable document sizes

You can set up to 50 sheets of letter-, legal- or half letter-sized document in the ADF at one time. However, it is possible to fax a piece of paper as small as a notepad sheet or one up to three feet long.

The acceptable dimensions (width × length) are:

Automatic document feeder (ADF)

SINGLE-SHEET

Maximum: 8.5" × 35.4"

Minimum: 4.7" × 3.9"

MULTIPLE-SHEET

Maximum: 8.5" × 14.0"

Minimum: 5.8" × 4.1"

Flatbed scanner (FBS)

Maximum: 8.5" × 14.0"

Things **not** to put in your fax

To avoid paper jams and damage to your machine, **don't insert:**

- Folded, curled, torn, wrinkled or very thin pages
- Documents with staples, glue, tape, paper clips or still-wet correction fluid
- Sticky notes (or documents with sticky notes attached)
- Cardboard, newspaper or fabric
- Pages with duplicating carbon on either side
- Credit cards or any small, thick items
- OHP transparency film

How to set the document

When setting the documents in the ADF (Automatic Document Feeder)

- 1** Insert your document(s) **face up, top edge first**. If you're sending a multi-page document, fan the pages slightly.
- 2** Adjust the document width guide to fit your documents.

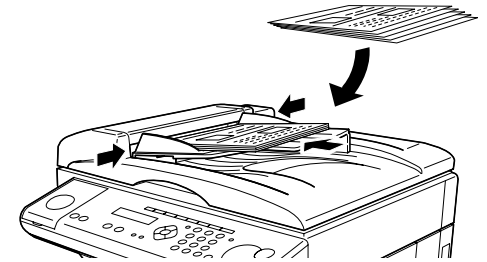

Note: The ADF can hold up to 50 pages of normal weight paper.

When setting the documents on the FBS (Flatbed Scanner) glass

- 1** Make sure the document is not in the ADF.
- 2** Lift the platen cover.
- 3** Set your document **face down** on the FBS glass. The document should be aligned to the **front right corner**.
- 4** Gently close the platen cover.

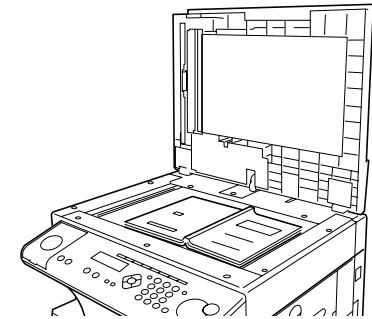

Important: Gently close the platen cover so that you don't catch your hands, possibly injuring them.

Resolution, grayscale

Reviewing resolution and grayscale:

Normal resolution (NORM on the control panel) is suitable for most typed documents and simple drawings.

Fine resolution (FINE on the control panel) is ideal for maps, moderately complicated drawings, floorplans or handwritten documents.

Superfine resolution (S-FINE on the control panel, S Fine on the LCD) reproduces the detail of extremely complicated drawings or line art.

Grayscale mode (HALFTONE on the control panel; Gray on the LCD) captures shades in photos and drawings.

Note: If you send a fax in superfine, certain fax models (especially older, non-Muratec models) receive it only in fine mode. However, you can send a fax in grayscale mode to virtually *any* fax machine currently in use.

To change the resolution setting, press **RESOLUTION** repeatedly. A glowing LED indicates the fax is using the setting named by that LED. For example, in the drawing (right), the machine is set for FINE resolution.

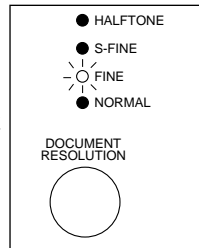

Contrast

Setting the contrast allows you to compensate for any excessive lightness or darkness, as the case may be, of document pages you are sending or copying.

To change the contrast setting, press **CONTRAST** repeatedly. A glowing LED indicates the fax is using the setting named by that LED.

Note: To avoid confusing the Light and Dark settings, just remember Light lightens and Dark darkens to keep it straight.

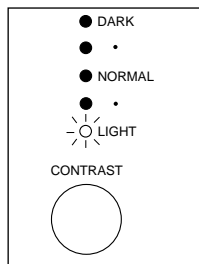

Mixing resolution and contrast in a multiple page

When you send the document with more than one page, you can select different resolutions and contrasts for each page.

Insert your documents, select resolution and contrast for first page, dial and press **START**. Then follow one of the following two procedures.

When the document is placed in the ADF:

Select resolution and contrast before the next page is scanned.

When the document is placed on the FBS glass:

- 1 Remove the previous page and place the next page.
- 2 Select resolution and contrast. Then press **NEXT DOC**.

Dialing pause

Some long-distance systems require dialing pauses, and pauses can also be useful when you re dialing through special telephone exchanges.

To insert a *pause*, just press **REDIAL/PAUSE**. (The pause character (-/) will appear on the LCD.) Each pause entered lasts for a factory-set two seconds.

For example, pressing **9, REDIAL/PAUSE, 19725552009** dials 9 [2-second pause] 1 9 7 2 5 5 5 2 0 0 9.

Helpful Tip: You can change the dialing pause length within 2 to 10 seconds. (see Changing the pause length, page 4.5.)

Potential problems with call-waiting and voice mail

Telephone call-waiting signals can stop fax transmission and reception. And any service such as voice mail which may intercept your calls can keep your fax machine from receiving fax calls.

If you use only one line for both phone and fax, consult your telephone company to see how you can temporarily disable call-waiting or voice mail while using the fax machine.

Memory transmission

Your fax machine has a great memory! Take advantage of it, and you could:

Save Time. By using your fax machine's memory, you won't have to wait for your machine while it completes the transmission. Simply scan your document into your machine's memory, and you can walk away with your original in hand.

Save Money. If you're transmitting to another memory-equipped fax machine, your machine will send the document directly into the other machine's memory and hang up. (The receiving machine then prints out your message from its memory after the call has ended.) This cuts your actual on-line time to a minimum.

Save Even More Money. Set up a delayed transmission (see page 3.11) to send your document after hours, and you can save more money, because the line charges will be cheaper.

Note: Some documents use up memory more quickly than others. They include documents with many pages and those with many dark areas. *When the machine's memory is full, it can transmit only through the document feeder.*

The memory transmission is *On* for default setting. However, you can turn off it for the default. (See page 4.2.)

Helpful Tip: You can override the default setting of memory transmission for only one transmission by pressing **MEMORY TRANSMISSION** before you send your document. After completing the communication, your machine will return to the default setting.

Memory overflow message

In normal memory transmission, if you've stored too much information in your machine's memory, a Memory Overflow message may appear on the LCD:

Memory Overflow
Start Or Cancel

This appears because **(1)** too many pages have been stored in the memory, **or (2)** the pages that are stored have too much information on them for your fax machine to remember.

If this message appears, press **START** to tell your fax to keep as many pages in memory as possible, or press **CANCEL** to erase from memory all pages stored during the current operation (but not previous operations).

Note: If you don't operate your machine within 60 seconds, the machine automatically erase the document stored in the memory during the current operation.

Dividing a large document into smaller batches will help you avoid this error.

Quick memory transmission

Using Quick Memory transmission can save you time over standard memory transmissions.

For a *normal memory transmission*, your fax: **(1)** scans your entire document into memory, **(2)** dials the other fax machine, then **(3)** transmits the document.

But with *Quick Memory transmission*, your machine doesn't wait to scan all pages into memory before dialing. After it scans the first page of your document, your machine dials the call. While dialing, connecting and transmitting, your fax machine continues to scan in the remaining pages of the document.

The quick memory transmission is *On* for default setting. However, you can turn off it for the default. (See page 4.2.)

Important: To use Quick Memory transmission, the memory transmission feature must be turned on.

Real time transmission (Non-memory transmission)

In the following cases, the machine does not use its memory for sending a fax:

- When you turned off the memory transmission

- When you are sending a fax using **MONITOR/CALL** key or optional handset (see page 2.6.)

- When the machine's memory is full

It is called *Real time transmission mode*. In this mode, the next page is not scanned in while the current page is being transmitted.

Note: In this mode, only one destination can be dialed.

Note: Real time transmission available only when using the ADF. When transmitting use the FBS glass, the machine always uses Memory transmission mode even if you set the memory transmission to off.

Sending a fax using the ADF

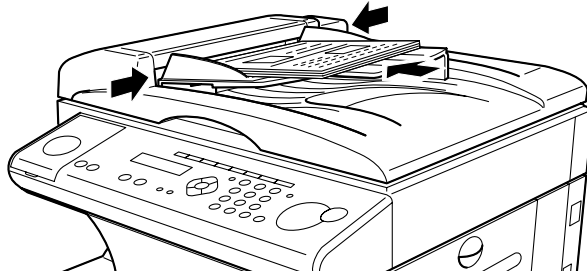

- 1** Press **COPY/FAX** to change to Fax mode.
- 2** Insert the document **face up, top edge first**. And adjust the document guides by sliding either of them to the left or right to fit the page(s) you'll be faxing. Your fax machine's ADF (Automatic Document Feeder) will hold up to 50 pages with letter-sized paper.

When a document is in the feeder, the LCD shows the scanning width (see A4 in the Glossary beginning on page 5.17) and the amount of memory available:

```
Document Ready
A4           Mem100%
```

- 3** Adjust *resolution* and *contrast* if necessary.
- 4** Enter the fax number.
Also, enter any access codes necessary, just as you would for a regular phone call. (Example: Enter 9 to dial out from an office telephone system, or 1 for long-distance.)

```
Press Start
919725552009_
```

- 5** Press **START**.
By pressing **START**, you've just given your machine a command. In turn, your machine gives this action a command number as it scans the fax document.

This command number appears on the first line of the LCD for a few seconds:

```
== Command:01 ==
```

You'll need to know this command number if you later wish to cancel the transmission or to print a stored document (see pages 2.8 2.9).

- 6** Now, everything is up to the machines—yours and the one you're dialing.
If the fax has been set for *Quick Memory transmit*, your machine scans the first page of your document into memory, then dials the other fax. When it makes contact, your machine transmits the stored document from memory while at the same time scanning the remaining pages of your document into memory. (In default setting, the *Quick Memory transmission* is *On*. If you want to turn off this feature, see page 4.2.)

If the fax has been set for the *normal memory transmit*, your fax scans the entire document into memory, then dials the other fax. When it makes contact, your machine transmits the entire stored document from memory.

If the fax is set for *Real time transmit (non-memory transmission)*, your machine simply dials the other fax. When it makes contact, your machine feeds the document through, scanning and transmitting it as it goes.

Note: The more stuff (called *black coverage*) your machine sees on a page, the more slowly the page feeds through as the fax scans it. And even if the page is relatively clean, sending it in grayscale mode or at certain resolutions makes your machine see more stuff. The same is true if you set the contrast to Dark.

Important: If you want to *cancel* a transmission while *scanning* the document, press the **STOP** key.
If you want to *cancel* a transmission in progress, use the *Review Commands* function. See *Reviewing or canceling commands*, page 2.8.

- 7** At the end of the operation, your fax machine beeps and displays:

```
919725552009
** Complete **
```

Important: Whenever you transmit a document, what actually appears on the top line of the display depends on information stored in the remote fax. The line may even be blank.

Note: If the call fails, see *Redialing*, page 2.7.

Sending a fax using the FBS glass

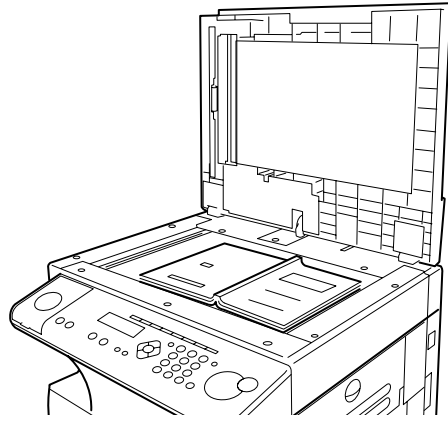

- 1 Press **COPY/FAX** to change to Fax mode.
- 2 If there is a document in the ADF, remove it.
- 3 Open the platen cover.
- 4 Place the document **face down** on the FBS glass and align it with the document scale on the right, then gently close the platen cover. The document should be aligned to the **right front corner**.

Important: Gently close the platen cover so that you don't catch your hands, possibly injuring them. When a thick document, such as a book, is on the FBS glass, **do not press strongly** from the top of the platen cover. This may break the FBS glass and cause an injury.

- 5 Press **DOCUMENT SIZE** to select the document size, letter (displayed as Ltr), legal (Legl) or half-letter (HLtr). (Half-letter is 8.5" wide 5.5" tall.)

```
Enter Scan Size
Ltr
```

```
Legl
```

```
HLtr
```

- 6 Adjust *resolution* and *contrast* if necessary.

- 7 Enter the fax number. Also, enter any access codes necessary, just as you would for a regular phone call. (Example: Enter 9 to dial out from an office telephone system, or 1 for long-distance.)

```
Press Start
919725552009_
```

- 8 Press **START**.

By pressing **START**, you've just given your machine a command. In turn, your machine gives this action a *command number* as it scans the fax document.

This command number appears on the first line of the LCD for a few seconds:

```
== Command:01 ==
```

You'll need this command number to cancel the transmission or to print a stored document (see pages 2.8 2.9).

Then your machine will scan the document into the memory. While your machine scans the document, the LCD will show:

```
919725552009
Ltr NextDoc Mem100%
```

- 9 When the scanning is done, the LCD will show:

```
Start Scan → NextDoc
Tx Start → Start
```

If you want to send more pages, proceed to step 10. Otherwise, press **START** to start the transmission, and skip to step 11.

- 10 Place the next page, then press **NEXT DOC** to start scanning.

Note: If necessary, select the document size (see step 5).

To send any more pages, repeat steps 9-10. Otherwise, press **START** to start the transmission, and skip to step 11.

- 11 Now, everything is up to the machines yours and the one you're dialing. When it makes contact, your machine transmits the stored document from memory.

Important: If you want to *cancel* a transmission while *scanning* the document, press the **STOP** key. If you want to *cancel* a transmission in progress, use the *Review Commands* function. See *Reviewing or canceling commands*, page 2.8.

12 At the end of the operation, your fax machine beeps and displays:

```
919725552009
** Complete **
```

Important: Whenever you transmit a document, what actually appears on the top line of the display depends on information stored in the remote fax. The line may even be blank.

Note: If the call fails, see Redialing, page 2.7.

Sending a fax using MONITOR/CALL key or a handset

You also can fax a document using either the monitor speaker or the optional handset to dial the call.

Note: In this function, you cannot send a fax using the FBS glass.

- 1** Insert the document to the ADF.
- 2** Adjust *resolution* and *contrast* if necessary.
- 3** Obtain a dial tone, either by:
Pressing **MONITOR/CALL**
or
Lifting the optional handset.

In either case, the LCD shows:

```
** Tel Mode **
_
```

- 4** Enter the fax number by using the numeric keypad.
Also, enter access codes with the number, just as for a regular phone call.

```
** Tel Mode **
919725552009_
```

- 5** When you hear fax tones from the remote unit, press **START**.

Note: If a person answers the phone, use the optional handset to tell that person that you're trying to send a fax. When you hear fax tones, press **START**.

- 6** If you're using an optional handset, hang up after pressing **START**.
- 7** At the end of the operation, your fax machine beeps and displays:

```
919725552009
** Complete **
```

Note: If the call fails and you used **MONITOR/CALL** to dial, press **MONITOR/CALL** to hang up. Or if you've pressed **START** to begin the fax transmission, press **STOP** to end it.

Also see Redialing manually, next page, if the call fails.

Redialing

Automatically fax redialing

If your fax call fails, your machine automatically redials it. In this *Auto Redial mode*, your fax *automatically redials* the number up to two times at one minute intervals.

Note: You can change the redial time and interval settings. (See *Changing redial settings*, page 4.5.)

While in the *Auto Redial mode*, the machine can continue to receive faxes and can make as many as 99 fax transmissions.

Note: If you used either the **MONITOR/CALL** key or a handset to dial the call, you must redial manually (see below).

Note: If the last redial attempt fails, your machine may print (and/or display) error messages.

Redialing manually

You can always redial calls manually. And you *must* redial manually if you used either the **MONITOR/CALL** key or an optional handset to dial the failed call.

*To redial a fax call manually without using the **MONITOR/CALL** key or an optional handset:*

- 1 Set the document and set the resolution and contrast.
- 2 Press **REDIAL/PAUSE**. The LCD will show:

View Redial History
0:1234567890
- 3 Your machine can remember the last 10 dial numbers. Press ◀ or ▶ until the dial number you want to redial appears.
- 4 Press **START**.

*To redial a fax call manually with the **MONITOR/CALL** key or an optional handset:*

- 1 Make sure the document is in the ADF and that the resolution and contrast are set.
- 2 Press **MONITOR/CALL** or lift the optional handset to get a dial tone.

- 3 Press **REDIAL/PAUSE**. The LCD will show:

View Redial History
0:1234567890

- 4 Your machine can remember the last 10 dial numbers. Press ◀ or ▶ until the dial number you want to redial appears.

- 5 When you hear fax tones from the remote unit, press **START**.

Note: If a person answers the phone, use the optional handset to tell that person you're sending a fax. When you hear fax tones, press **START**.

To redial a voice call manually using the optional handset:

- 1 Lift the optional handset to get a dial tone.

- 2 Press **REDIAL/PAUSE**. The LCD will show:

View Redial History
0:1234567890

- 3 Your machine can memory the latest 10 dial numbers. Press ◀ or ▶ until the dial number you want to redial appears.

- 4 Press **START**.
When the other person answers, use the optional handset to speak to that person.

Reviewing or canceling commands

Your fax machine can store many jobs in its memory. And it keeps track of each one by assigning it a command number, like C01.

Delayed commands, redial attempts and current fax transmissions are all stored in your fax machine's memory and given a command number. Your machine can store up to 99 delayed commands. It identifies each by a two-digit *command number* ranging from 01 to 99.

The Review Commands function gives you the power to check on each job (or command) in your machine's memory. It also lets you cancel a command if you decide not to send the document.

To see your machine's stored commands or to cancel them:

1 Press REVIEW COMMANDS.

The LCD shows the *first* command, indicated by its command number and the phone number it will dial.

If a command is in progress, that will be the first command the LCD shows:

```
C01:5552009
  ↑↓/→/Cancel
```

If there are no stored commands in your machine It beeps briefly and displays No Command on the LCD. It then returns to standby mode.

Here, you see *command 01*, followed by the number it's set to dial. If the command is to send a *broadcast*, Broadcast appears instead of the phone number. (See Broadcasting, page 3.10.)

If the command is to send a *batch transmission*, the LCD shows its *batch box number* (such as B01) rather than the command number. (See Batch transmission, pages 3.12-3.14.)

If the command is for a *Call group dialing*, the group number (such as G01) appears instead of the phone number. (See Call group dialing, page 3.8.)

Note: If your machine is attempting to perform a command *now*, it appears on the display.

2 Press ▲ or ▼ to scroll through currently stored commands.

3 If you want to cancel the command shown, press CANCEL. The LCD shows:

```
C01:9-5552311
Check  ↑↓/→/Cancel
```

4 To go ahead with canceling the command, press CANCEL again. Go back to step 2 to view other delayed commands.

To *keep* this command but to continue reviewing stored commands, press ▲ or ▼. Go back to step 2.

To keep this command *and* stop reviewing commands, press STOP to return your machine to standby mode.

Note: See also Reviewing or canceling parts of a broadcast, below.

Reviewing or canceling parts of a broadcast

You also can review or cancel certain numbers within a broadcast:

1 Press REVIEW COMMANDS.

2 Press ▲ or ▼ to scroll through currently stored broadcast command.

Note: Stop this operation at any time by pressing STOP.

```
C01:Broadcast
  ↑↓/→/Cancel
```

3 If you want to cancel the command shown, press CANCEL, CANCEL.

If you want to review *individual* numbers within this broadcast, go on to step 4 *without* pressing CANCEL.

4 To review *individual* numbers within this broadcast, press ► (or BROADCAST) to see the first number. The LCD shows:

```
9-5550388
  ↑↓/←/Cancel
```

5 Press ▲ or ▼ until you find the number you want to cancel.

6 Press CANCEL, CANCEL. The next number will appear.

If you want to cancel this number, also, repeat this step.

If you want to cancel a different number, go back to step 5.

If you want to go back to reviewing or canceling other command, press ◀.

If you don't want to cancel any more numbers, press STOP. The machine returns to standby mode.

Printing a delayed command list

Your machine can print a *command list* which tells you:

The command's identification number

The phone number, or remote location

The start time (this appears in a *DD,HH:MM* format)

A note telling if the command is a *polling* or *F-Code* operation (see pages 3.15-3.16 for more on *polling* and 3.26-3.35 for more on *F-Code communication*).

To print a delayed command list, press **Program key, E, 1, 0, 5 ENTER**.

Printing a stored document

Your fax machine can print out each document stored for delayed transmission.

To print a stored document, you'll need to know the document's command number, which you can get by either reviewing the commands or printing a delayed command list (see above).

1 Press **Program key, D, 3, 0, 5 ENTER**. The LCD shows:

```
Com. Stored Doc.
Command No.      :_
```

2 Use the numeric keypad to enter the command's identification number, *1-99*. For example, we could enter the following for the very first command, *1*:

```
Com. Stored Doc.
Command No.      :1_
```

3 Press **ENTER**. Your fax machine will print a copy of the stored document.

Receiving faxes

Answering calls manually

In any reception mode, you can always answer calls manually *if you have an optional handset installed*. Just pick it up, as you would if using a normal phone.

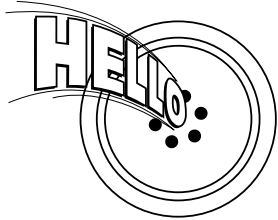

If you hear someone speaking to you, use your optional handset to speak back.

If you hear *fax tones* (beep beep beep), press **START** and hang up the optional handset. The fax machine will begin receiving a fax.

Note: Don't try to answer a call by pressing **MONITOR/CALL**. The monitor function is for dialing only.

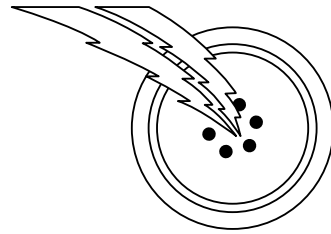

Answering fax calls using another phone, not the fax machine

If you have one phone line ringing to several phones in your office and *you have an optional handset attached to your fax*, there's no need to run to the fax machine to answer every call. If you happen to answer a fax call while you're at another extension, put the handset down, but don't hang up. Walk to the fax machine and pick up the optional handset. Then press **START**.

After you press **START**, hang up both the fax machine's optional handset and the second telephone's handset. Because remote fax machines will wait several seconds to hear reception tones from your unit, you have about 30 seconds to walk to your fax, pick up the handset, and press **START**.

While using an optional handset for your call, if you press **COPY RESET**, the LCD shows the current fax reception mode. Press **COPY RESET** again to return to the TEL mode.

Reception modes

Your fax machine has five different reception modes — *Tel Ready, Fax Ready, Fax/Tel Ready, Tel/Fax Ready* and *Ans/Fax Ready*. We'll explain each of these in this section.

Tel Ready mode

Use it if: You want to use the same line for both fax and phone calls *and* On that line, you're using at least one other phone which is *not* connected to your fax machine *or* You have an optional handset installed on your fax machine

In this mode: Your fax machine never answers calls automatically. You must answer each call as described in *Answering calls manually* (this page, left column).

Fax Ready mode

Use it if: Your fax machine uses its own phone line and doesn't share it with a phone or an answering machine.

In this mode: Your fax machine answers each call and attempts to receive a fax.

Fax/Tel Ready mode

The Fax/Tel Ready mode is a combination of the Fax Ready and Tel Ready modes.

Use it if: An optional handset is installed on your fax machine *and* You're using the machine as both a fax machine and a telephone

In this mode: Your fax machine receives faxes silently *but also* alerts you when a regular voice call comes in. (Your fax machine also beeps once at the end of each reception.)
If a voice call comes in, your fax machine detects it and sounds a special ring. If you hear it, answer using your optional handset.

Note: This Fax/Tel Ready mode won't turn off ringers on other telephones in your house or office. Other phones won't distinguish between fax and voice calls.

Tel/Fax Ready mode

The Tel/Fax Ready mode is a combination of the Tel Ready and Fax Ready modes.

Use it if: An optional handset is installed on your fax machine
and
You're using the machine as both a telephone and a fax machine

In this mode: Your fax machine rings the number of times you've identified in the user settings (the default setting is two times). If you don't use the optional handset to answer the call, your fax machine answers the call. If a caller sends a fax, your machine begins receiving it. If a voice call comes in, your machine detects it and sounds a special ring, telling you to answer using the optional handset.

Ans/Fax Ready mode

Use it if: You're using an answering machine that's connected directly to your fax machine.

In this mode: An answering machine connected to your fax machine answers each call. If a voice call comes in, the answering machine begins to record the incoming message. If your fax machine hears a fax tone, it begins receiving the fax message.

Using an answering machine with your fax machine

To connect your answering machine to your fax machine:

- 1 Set the fax machine for Ans/Fax Ready, as described on right column.
- 2 Set your answering machine to answer calls after *no more than* two rings. (See the answering machine's instructions if necessary.)
- 3 Create a new outgoing message on your answering machine. Here's a suggested message:

*Hello! You've reached [your name or telephone number]. To leave a **voice** message, please wait for the beep. To send a **fax**, press **START** on your fax machine. Thanks for calling!*

Important: Your answering machine's outgoing message must be *no longer than* 10 seconds.

Detection of silent fax machines

Some older fax machines don't send fax tones when transmitting, which can cause problems when using an answering machine with your fax.

But your fax machine can accommodate these silent machines *without* disrupting your answering machine operation.

How to select the fax reception mode:

- 1 Press **Program key**, **I**, and then press **ENTER** *seven times*. The LCD shows your current fax reception mode:

Fax Ready
← / → / Enter

- 2 Press **◀** or **▶** until your desired reception mode is appeared.

Fax/Tel Ready
← / → / Enter

- 3 Press **ENTER** to save the setting.

If the paper runs out while fax reception

When your machine runs out of paper, it beeps, the red light of the printer status lights glows and the LCD shows which source has run out of paper—the 1st cassette, 2nd cassette (optional) or the bypass tray.

In this example, the machine runs out of paper in 1st cassette:

1st Cassette
Please Supply Paper

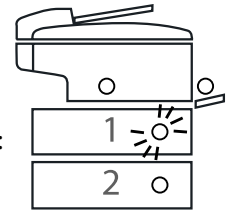

Helpful Tip: If the letter, legal or half-letter sized paper has been set in the bypass tray, your machine uses it when running out of paper in the paper cassette(s) during fax reception. Your machine's bypass tray can hold up to 50 sheets of the paper.

Your fax machine cannot *print* fax messages without paper. But it can still receive documents into its memory, as described in the section below.

Out-of-paper reception

If your machine runs out of paper, it stores up to 250 fax *receptions* in its memory. This is called *out-of-paper reception*. Once you refill the paper supply, the fax machine prints the stored messages automatically.

Note: The number of *pages* (not *receptions*) your fax machine can store for out-of-paper reception will vary. It depends on:

- Your machine's memory capacity
- Types of documents being sent to your machine
- Resolution of documents being sent to your machine

Making copies

Your machine's copier features

Your machine has the following copier features:

- Single copy (see the right column on this page)
- Stacking multiple copies (see page 2.12)
- Sorting multiple copies (see page 2.12)
- Enlarged or reduced copies (see page 2.13)
- Negative/positive copy (Reverse black and white areas) (see page 2.16)
- Combine copy (see page 2.17)
- Ultra copy mode (see page 2.17)

Basic copy procedure

- 1 Press **COPY/FAX** to change to Copy mode.

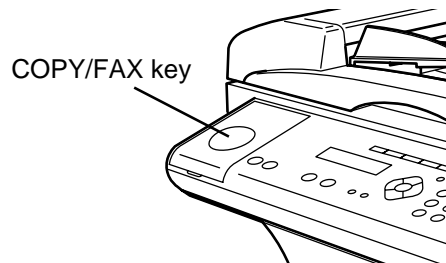

When the machine is in the Copy mode, the LCD shows:

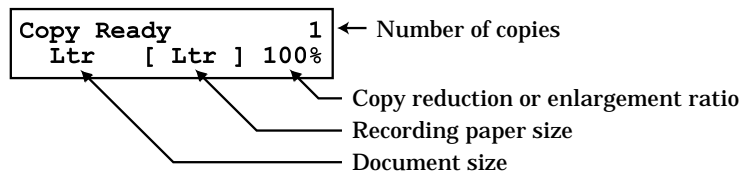

Note: For details about each item, see Making copy settings, page 2.15

- 2 Place your original document in ADF **face up**, or on the FBS glass **face down** just as you would to send a fax.
- 3 Enter the document size by pressing the **DOCUMENT SIZE**.
- 4 As needed, set the following:
 - Select document type and adjust image contrast
 - Enter the number of copies
 - Set copy reduction or enlargement ratio

Note: For details about each item, see Making copy settings, page 2.15.
- 5 Press **START**.

Note: To reset the copy parameter to default setting, press **COPY RESET**.

Note: To stop the copying, press **STOP**.

Single copy

- 1 Press **COPY/FAX** to change to Copy mode.
- 2 Place your original document in ADF **face up**, or on the FBS glass **face down** just as you would to send a fax.
- 3 If you are using FBS glass, enter the document size by pressing the **DOCUMENT SIZE**.
- 4 As needed, set the following:
 - Select document type and adjust image contrast
 - Set copy reduction or enlargement ratio

Note: If you want to enlarge copy, use the FBS glass.
- 5 Press **START**.

Stacking multiple copies

- 1** Press **COPY/FAX** to change to Copy mode.
- 2** Turn the sort setting off. (See page 2.16.)
Note: The default setting of sorting is on.
- 3** Place your original document in ADF **face up**, or on the FBS glass **face down** just as you would to send a fax.
- 4** Enter the document size by pressing the **DOCUMENT SIZE**.
- 5** Using the numeric keypad to enter the number of copies you want (up to 99).
- 6** As needed, set the following:
Select document type and adjust image contrast
Set copy reduction or enlargement ratio
Note: For details about each items, see Making copy settings, page 2.15.
- 7** Press **START**.

Note: To stop the copying, press **STOP**.

Sorting multiple copies (using ADF)

Note: You cannot use the FBS glass for sorting multiple copies.

- 1** Press **COPY/FAX** to change to Copy mode.
- 2** Make sure the sort setting is turned on. (See page 2.16.)
- 3** Place your original document in ADF **face up**, just as you would to send a fax.
- 4** Enter the document size by pressing the **DOCUMENT SIZE**.
- 5** Using the numeric keypad to enter the number of copies you want (up to 99).
- 6** As needed, set the following:
Select document type and adjust image contrast
Set copy reduction ratio
Note: For details about each items, see Making the copy settings, page 2.15.
- 7** Press **START**.

Note: To stop the copying, press **STOP**.

Enlarged or reduced copies

Your fax machine is capable of enlargement and reduction when copying.

Note: The copy enlargement and reduction rate setting is available only for copying, not for faxing.

Important: Copy enlargement is available only for copying using the FBS; it is not available for copying using the ADF.

- 1** Press **COPY/FAX** to change to Copy mode.
- 2** Place your original document in ADF **face up**, or on the FBS glass **face down** just as you would send a fax.
Note: If you want to enlarged copy, use FBS glass.
- 3** Enter the document size by pressing the **DOCUMENT SIZE**.
- 4** Choose an enlargement or reduction ratio using **▲** or **▼** of the cursor key.
You can reduce to 78%, 64 % or 50 % of the original size
O R
You can enlarge to 129% or 200 %
O R
Press **zoom** to turn the **zoom light** on, and adjust the ratio at 1% steps using **▲** or **▼** of the cursor key. You can enter the ratio between 50% and 200%.
O R
Directly enter any percentage between 50 % and 200 % by following procedure.
1. Press #.
2. Using the numeric key to enter your desired ratio (50 to 200).
3. Press # again.

129%: Half-letter (5.5" 8.5") → Letter (8.5" 11")
78%: Legal (8.5" 14") → Letter (8.5" 11")
Helpful Tip: You can set the copy reduction or enlargement ratio to Auto . (See Setting copy auto, page 4.7.) If the Auto is set and you set the document size by pressing **DOCUMENT SIZE**, the machine automatically reduce or enlarge the original size (you entered) to fit on the paper size you selected.
- 5** As needed, set the following:
Select document type and adjust image contrast
Enter the number of copies
- 6** Press **START**.

Note: To reset the copy parameter to default setting, press **COPY RESET**.

Note: To stop the copying, press **STOP**.

Using the bypass tray

When you need to use a size of paper not currently loaded in your machine's paper cassette(s), or when you want to use a special type of paper (such as transparency film), use the bypass tray.

Important: If loading transparency (OHP) film into the bypass tray, be sure that the sheet is designed for laser printers and not for copiers. Also, be sure that the film does not have a paper backing and/or a leading strip. If it does, remove the paper backing and/or strip before inserting. Only film should go in, not film with any backing or strip.

- 1 Either insert the document in the **ADF** or place it on the **FBS** glass.
- 2 Set the paper in the bypass tray.
See the table of Acceptable paper size and cassette capacity on page 1.8 and Loading paper in bypass tray on page 1.10 for more information.

Note: Place the original document in the same orientation as the paper in the paper source (which you'll select in step 5, below).

- 3 Press **PAPER SIZE** to select the bypass tray until the light of the bypass tray of the printer status lights on the control panel glows.
- 4 If necessary, select desired resolution, contrast, reduction/enlargement ratio.
- 5 Press **START** to begin the copying process.

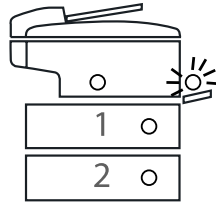

Memory overflow message

If you've stored too much information in your machine's memory, a Memory Overflow message may appear on the LCD:

Memory Overflow
Start Or Cancel

This appears because **(1)** too many pages have been stored in the memory, **or (2)** the pages that are stored have too much information on them for your fax machine to remember.

If this message appears, press **START** to tell your machine to copy as many pages in memory, or press **CANCEL** to delete from memory all pages stored during the current operation (but not previous operations).

Note: If you don't operate your machine within 60 seconds, the machine will automatically print the document stored in the memory during the current operation.

If the paper runs out while copying

When your machine runs out of paper, it beeps, the red light of the printer status lights glows and the LCD shows which source has run out of paper—the 1st cassette, 2nd cassette (optional) or the bypass tray.

In this example, the machine runs out of the paper in the 1st cassette:

1st Cassette
Please Supply Paper

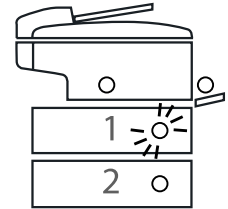

If you want to cancel the current copying job, press **STOP**. Otherwise, supply the paper to the displayed paper source to resume the copying.

Making copy settings

When the machine is in the Copy mode, the LCD shows:

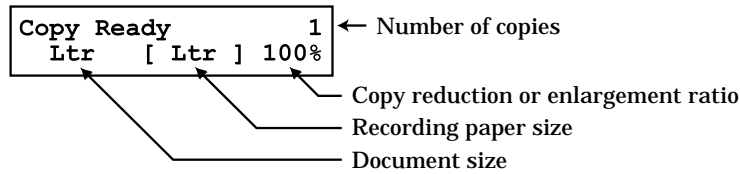

Number of pages

Use the numeric keypad to enter the desired number of copies for the document.

Copy reduction or enlargement rate

Your fax machine can make enlarged and reduced copies. For more information, see Enlarged or reduced copies, page 2.13.

Document size

To select the document size manually, press **DOCUMENT SIZE** repeatedly until your desired document size appears. You can choose the Letter, Legal or Half letter:

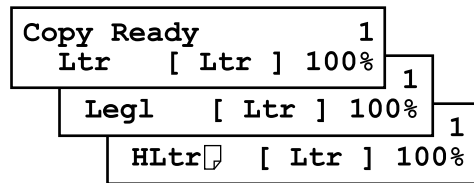

Note: When the document size is set to Auto (see Setting copy auto, page 4.7) you may see the LCD as below:

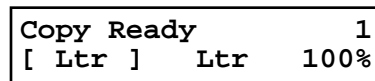

[] means the machine automatically select the document size.

Note: According to the magnification ratio or recording paper size, the document size will be not displayed:

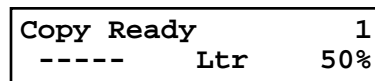

Recording paper size

As default, your machine selects the paper source automatically, however if you wish to select the paper source manually, press **PAPER SIZE** repeatedly until your desired paper size is displayed. The LCD toggles the paper size in the 1st cassette, 2nd cassette (if installed), the bypass tray and **Auto** select mode.

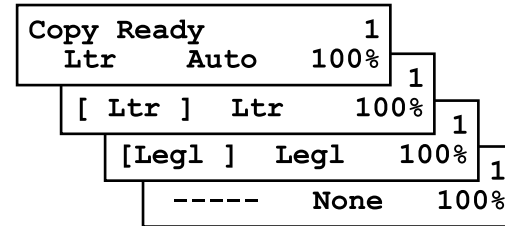

Note: If the bypass tray has no paper, the LCD shows None for the paper size of the bypass tray.

Note: When you choose the auto paper select mode, the LCD shows **Auto** and the all LED of the paper source will be lit.

However, if the bypass tray has no paper and the optional 2nd paper cassette has not been installed, the machine will show the [(paper size)] instead of **Auto** although you select auto paper select mode. And it lights the LED of the paper source that can be used only.

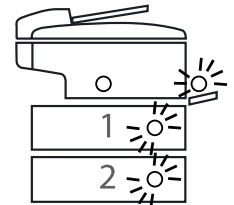

Select Document type

PHOTO Select this mode when copying photographs or drawings.

PHOTO/TEXT Select this mode when copying documents containing photographs or drawings with letters.

TEXT Select this mode when copying letters.

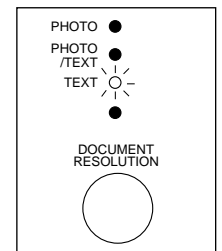

To select the document type, press **DOCUMENT** repeatedly.

A glowing LED indicates the machine is using the setting named by that LED.

Adjust image contrast

Setting the contrast allows you to compensate for any excessive light or darkness, of the document pages you are copying.

To change the contrast setting, press **CONTRAST** repeatedly. A glowing LED indicates the machine is using the setting named by that LED.

Note: To avoid confusing the Light and Dark settings, just remember Light lightens and Dark darkens to keep it straight.

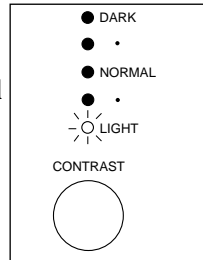

Sort copy setting

Default setting: On

Helpful tip: If you frequently turn this feature off and on, you can set a Soft key (see page 3.17) to turn on or off by simply pressing that key.

1 Press **Program key, B, 3, 0, 6**.

2 Press **ENTER**.
The LCD shows the current setting:

```
Sort Copy      :On
← / → / Enter
```

3 Press **◀** or **▶** until the setting you want appears.
In this example, we've chosen *Off*.

```
Sort Copy      :Off
← / → / Enter
```

4 Press **ENTER** to save the setting.

Special copy function

Negative/Positive (reversing black and white areas)

If using this feature, the black and white areas of the original are reversed.

Note: You cannot combine this feature with *Reduced* or *Enlarged* copies.

Helpful tip: If you programmed a Soft key to turn on or off this feature, simply pressing that key will turn on or off this feature.

- 1** Make sure the machine is in the Copy mode.
- 2** Place your original document in ADF face up, or on the FBS glass face down.
- 3** Enter the document size by pressing the **DOCUMENT SIZE**.
- 4** Press **ADVANCED FUNCTIONS, ENTER**. The LCD shows the current setting:

```
Nega/Posi     :Off
← / → / Enter
```

Note: This feature is *Off* for default setting. However, you can turn on it for the default. (See page 4.7.)

5 Press **◀** or **▶** until the setting you want appears.
In this example, we've chosen *On*.

```
Nega/Posi     :On
← / → / Enter
```

6 Press **ENTER** to save the setting. The machine returns to the standby mode with following display:

```
Copy <Nega/Posi> 1
Ltr [ Ltr ] 100%
```

- 7** As needed, set the following:
Select document type and adjust image contrast
Enter the number of copies
- 8** Press **START**.

Note: To reset the copy parameter to default setting, press **COPY RESET**.

Note: To stop the copying, press **STOP**.

Combine

Note: This feature is available only for MFX-1600 model.

This feature allows you to copying from four one-sided originals to one sheet of paper.

- 1 Make sure the machine is in the Copy mode.
- 2 Place your original document in ADF face up, or on the FBS glass face down.
- 3 Enter the document size by pressing the **DOCUMENT SIZE**.
- 4 Press **ADVANCED FUNCTIONS** *twice*, **ENTER**. The LCD shows the current setting:

```
Combine      :Off
←/→/Enter
```

Note: This feature is *Off* for default setting. However, you can turn on it for the default. (See page 4.7.)

- 5 Press **◀** or **▶** until the setting you want appears. In this example, we've chosen *On*.

```
Combine      :On
←/→/Enter
```

- 6 Press **ENTER** to save the setting. The machine return to the standby mode with following display:

```
Copy <Combine> 1
Itr [ Itr ] 100%
```

- 7 As needed, set the following:
 - Select document type and adjust image contrast
 - Enter the number of copies
 - Set copy reduction or enlargement ratio
- 8 Press **START**.

Note: To reset the copy parameter to default setting, press **COPY RESET**.

Note: To stop the copying, press **STOP**.

Ultra copy mode

Note: This feature is available only for MFX-1600 model.

Note: The enlargement/Reduction copy is not available with this mode.

Note: This mode needs more memory than normal mode. So when you try to make many copies at a time, the memory overflow may occur.

This feature allows you to copying with more high quality resolution.

- 1 Make sure the machine is in the Copy mode.
- 2 Place your original document in ADF face up, or on the FBS glass face down.
- 3 Enter the document size by pressing **DOCUMENT SIZE**.
- 4 Press **ADVANCED FUNCTIONS** *three times*, **ENTER**. The LCD shows the current setting:

```
Ultra Copy   :Off
←/→/Enter
```

- 5 Press **◀** or **▶** until the setting you want appears. In this example, we've chosen *On*.

```
Ultra Copy   :On
←/→/Enter
```

- 6 Press **ENTER** to save the setting. The machine return to the standby mode with following display:

```
Copy <Ultra Copy> 1
Itr [ Itr ] 100%
```

- 7 As needed, set the following:
 - Select document type and adjust image contrast
 - Enter the number of copies
- 8 Press **START**.

Note: To reset the copy parameter to default setting, press **COPY RESET**.

Note: To stop the copying, press **STOP**.

Copy protection

With such a versatile copier built right into your fax machine, you might want to make sure it doesn't become too tempting to unauthorized copying that could deplete your machine's supplies more rapidly. So, to limit the use of your fax machine to only sending and receiving faxes—in other words, to activate *copy protection*:

- 1 Press **Program key, B, 3, 0, 5, ENTER**.

```
Copy Protect :Off
←/→/Enter
```

- 2 Press **◀** or **▶** until the setting you want appears. In this example, we've chosen *On*.

```
Copy Protect :On
←/→/Enter
```

- 3 Press **ENTER** to save the setting.

```
Copy Protect
** Complete **
```

Whenever someone tries to change the machine to Copy mode, the machine will sound a brief alarm tone and display:

```
Fax Ready
Copy Off
```

To turn copy protection to use the machine's copying function, repeat steps 1-3, in step 2, you press **▶** so that the display shows:

```
Copy Protect :Off
←/→/Enter
```

Using your fax machine as a phone

Your fax machine can also be used as a phone, if you have an optional handset installed. The following is a brief look at the machine's telephone features.

Dialing a telephone number

- 1** Pick up the optional handset. You will hear a dial tone.
- 2** Dial the number by the using numeric keypad.
or
Press the one-touch key. (See One-touch phone dialing, on page 3.4.)
or
Press **SPEED DIAL/TEL INDEX** once, then press the three digit speed-dial number. (See Phoning via speed-dial, on page 3.7.)
or
Press **TEL INDEX/TEL INDEX** twice, then search the name you want to call using the cursor key. (See Easy dial directory dialing, page 3.9.)
- 3** When the other person answers, begin speaking.

On-hook dialing

Because your machine has a monitor speaker, you can dial without picking up the optional handset. For hands-free dialing:

- 1** Press **MONITOR/CALL**. You'll hear a dial tone (unless you have set your speaker volume to *Off*; see page 1.8), and the LCD shows:

```

** Tel Mode **
_

```

- 2** Dial the number you want. Use either the numeric keypad, a one-touch key, a speed-dial number or telephone index to dial.

Important: Your machine's monitor speaker is *not* a *speaker phone*. If a person answers the call, pick up the handset to speak.

Note: If the call fails, press **MONITOR/CALL** to hang up.

Redial

- 1** Lift the optional handset to get a dial tone.
- 2** Press **REDIAL/PAUSE**. The LCD will show:

```
View Redial History
0:1234567890
```
- 3** Your machine can remember the latest 10 dial numbers. Press ◀ or ▶ until the dial number you want to redial appears.
- 4** Press **START**.
When the other person answers, use the optional handset to speak to that person.

Call request

You can send or receive a fax message *and* have a regular phone conversation *on the same call*.

For more information on how to use this function, see page 3.25.

Changing the dialing type

If, with your machine set for pulse dialing, you must enter tones (DTMF) during a call, press **DIALING OPTIONS** once (the ! symbol will be shown on the LCD). Your machine now will tone dial all subsequent numbers.

Note: Using this key enables tone transmission from the numeric keypad after the call is connected. When you hang up the call, your machine will return to pulse dialing for the next call.

Dialing in the event of a power failure

Your fax machine can only receive telephone calls even in the event of a power failure, if an optional handset is attached. *But it cannot* send or receive a fax document.

Attaching an optional handset

You may purchase an optional handset for your fax machine. Here is how to attach the handset.

- 1 Using a Phillips-head screwdriver, attach the handset cradle to the left side of your machine, using the screws included with the cradle.

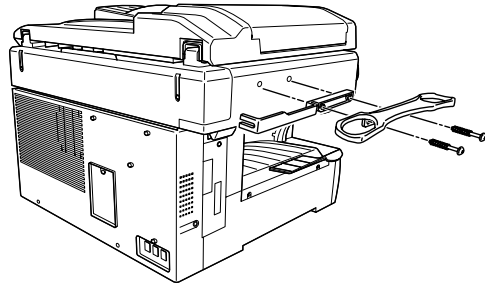

- 2 Plug one end of the handset cord (it's curled) into the **PHONE1** jack on the rear side of your machine.

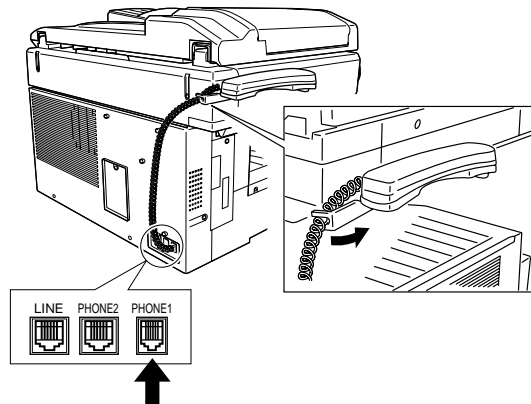

- 3 Plug the other end of the handset cord into the jack on the handset. If connected to a phone line, your fax machine is now off-hook.

Note: The handset has a small flash button which you can press while holding the handset, putting the fax machine back on-hook until you can hang up the handset properly in step 4.

- 4 Place the telephone handset onto the handset cradle. The cradle will press the handset's flash button, hanging up the handset.

Attaching a second phone

Want to attach a second phone (even a cordless model!) to your fax machine, so they can share the same phone jack? No problem.

Before we go further, let's explain the idea. You're plugging the second phone's phone line into your machine's **PHONE2** jack, not the wall phone jack. In such a setup, only your machine connects to the wall. The second phone receives phone signals through your machine.

Now, let's proceed

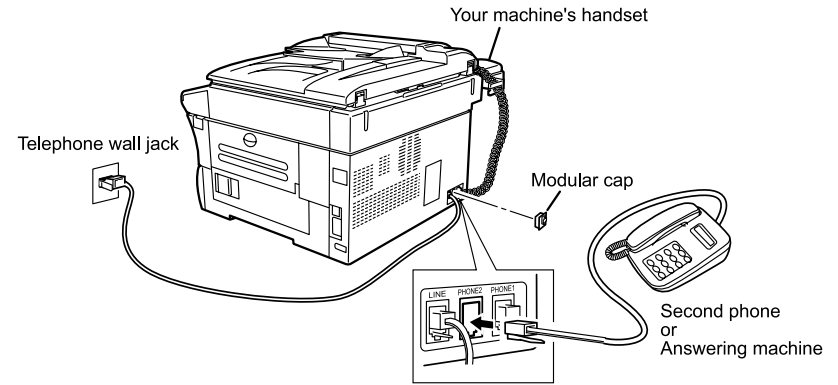

- 1 If your second phone is already plugged into a wall phone jack, disconnect it from that jack. Hold onto the phone plug; you'll need it in step 2.

Note: Of course, if your second phone is a model which requires AC power, as is true for the base of a cordless phone, don't unplug it from its AC power jack!

- 2 Using the plug mentioned in step 1, plug the phone cable from your second phone into the **PHONE2** jack on the left side of your fax machine.

This page intentionally blank.

Advanced Features

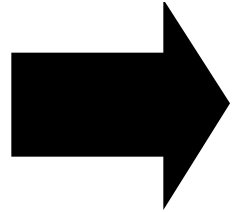

*This chapter describes
convenient features of your
machine.*

Autodialer	3.1
Broadcasting	3.10
Delayed transmission	3.11
Batch transmission	3.12
Polling	3.15
Special features	3.17
Security features	3.50

Autodialer

Your fax machine's *autodialer* stores your most frequently called phone and fax numbers for instant recall so you don't have to remember them. It's something like an electronic phone book.

Autodialer basics

How do you autodial?

There are two kinds of autodialer numbers. The difference between the two is how you dial them:

Type	How to dial	Amount stored
<i>One-touch</i>	Press one of the keys, marked 01 55 on the left side of the control panel	55
<i>Speed-dial</i>	Press SPEED DIAL/TEL INDEX followed by a three-digit identifier, from <i>001</i> to <i>145</i>	145
Total amount of numbers stored		200

Location IDs and the EasyDial directory

When you store numbers in your autodialer, you can give these numbers descriptive names, such as *Chicago office* or *Billing department*. Your machine calls this name a *Location ID*.

Your machine's autodialer sorts these location IDs alphabetically. Using your *EasyDial directory*, you can look up these numbers by their descriptive names, just as if you were using a phone book.

We'll explain how to store the numbers and location IDs in the next few pages. The *EasyDial directory* is discussed in detail on page 3.9.

Special Dialing Characters

Your fax machine allows you to enter special dialing characters when programming the autodialer. These characters include hyphens, which make phone numbers easier to read, and special characters needed for international calls.

The chart below briefly describes each of these characters. It also tells you what keys to press on your fax machine to store those characters in your autodialer:

Char.	What it does	Keystroke(s)
–	Makes long numbers easier to read. Doesn't change fax machine operation.	DIALING OPTIONS (<i>once</i>)
/	(<i>Has no effect in the United States.</i>)	DIALING OPTIONS (<i>twice</i>)
!	Tells your fax machine to pause until it hears a dial tone.	DIALING OPTIONS (<i>3 times</i>)
– /	Enters a pause. Each pause lasts two seconds (or whatever length you set; see page 4.5). Each pause uses <i>two</i> of the characters you can store in one phone number.	REDIAL/PAUSE [<i>after you enter at least one other character</i>]
– !	If your fax machine is on a pulse (<i>not</i> tone-dialing) line, switches from pulse-dialing to tone (DTMF)-dialing. Use after the actual phone number but before any characters (such as a long-distance carrier's access code) which must be in DTMF tone. <i>Do not</i> use on a tone line.	DIALING OPTIONS (<i>4 times</i>)

Call groups

As you set up your autodialer, you may also want to set up *call groups*. These are sets of phone numbers that make it easy to send the same fax to many different locations. For example, one call group may include all of your clients in one city, another group may include all of your employees and another may include all your vendors. Your fax machine can store as many as 200 numbers in up to 32 call groups. See also Call group dialing, page 3.8.

Using one-touch keys

Your fax machine stores up to 55 one-touch numbers using the keys marked **01**–**55**.

Entering or changing a one-touch number

- 1 Press **Program key, A, 1, 0, 1, ENTER**. The LCD shows the empty one-touch number.

```
Select One-Touch
01:No Number Stored
```

Note: If a one-touch number other than **01** appears on the LCD, it means that you have already entered a number for **01**.

- 2 Press the one-touch key in which you want to store a number or change a previously stored number. Here, we've selected **02** and the LCD shows either:

```
Select One-Touch      or      Select One-Touch
02:No Number Stored    02:9-1-555-987-6543
```

Note: If you want to select a different one-touch key, press that key now.

- 3 Press **ENTER**. Depending on whether you already have a number entered for this one-touch number, the LCD now shows either:

```
02:Fax Number          or      02:Fax Number
_                       9-1-555-987-6543_
```

- 4 Use the numeric keypad to enter the number *exactly* as your machine should dial it, including whatever access codes your phone system requires. (You may want to review Special dialing characters, page 3.1.) The number can be up to 40 characters in length:

```
02:Fax Number
9-/1-5559292039_
```

Your LCD can show only 20 characters at a time. To view characters beyond those 20, press **◀** to scroll to the left or **▶** to scroll to the right.

- 5 When the number is as you want it, press **ENTER** to store it.

- 6 The LCD now shows either:

```
02:Alt. No.           or      02:Alt. No.
_                       9-1-555-987-6553_
```

You now have the option to enter (or change) an *alternative* number. Your fax machine will dial this alternative number during a transmission after all redial attempts to the regular number fail. If the alternative number also fails, the fax alarm beeps to alert you to a problem.

Note: You can enter one alternative number for one speed-dial or one-touch number you entered. Your fax holds a maximum of 10 alternative numbers in all, that is, only 10 speed-dials or one-touch numbers can have the alternative number. After you have entered the alternative numbers for 10 speed-dials or one-touch numbers, your machine will no longer show this display.

If you want to enter (or change) an alternative number, enter it now. The number can be up to 40 characters long.

If you *do not* want to enter or change an alternative number, go on to step 7.

- 7 Press **ENTER**.

- 8 The LCD now shows:

```
02:Name      ;Upper    or      02:Name      ;Lower
_             _         S. W.Region Office_
```

The machine is now prompting you for a name a Location ID so you'll be able to find it in the EasyDial directory (see page 3.9).

If you *do* want to enter or change this Location ID, go on to step 9.

If you *do not* want to enter or change this Location ID, skip to step 10.

- 9 Enter the Location ID by using the one-touch keys. (If necessary, review Entering characters, page 1.12.) A number's Location ID may be up to 24 characters in length.

- 10 Press **ENTER** to save the setting and continue.

- 11 The LCD now displays:

```
02:Group No.          or      02:Group No.
_                       2,6_
```

You may now assign this number to up to 32 call groups. (If necessary, review Call groups, left column.)

If you *do* want to enter or change the call group number, go on to step 12.
If you *do not* want to enter or change this number's call group, go to step 13.

- 12** Use the numeric keypad to enter the call groups for this number. There are 32 possible call groups, numbered 1-32.

Here, we've entered **3** to assign this one-touch number to *Call Group 3*:

```
02:Group No.
3_
```

If you want to assign the number to more than one call group, insert a *comma* after each number (except the last one) by pressing **GROUP**. For example, if you enter **3, GROUP, 1, 6, GROUP, 2, 7** to assign this one-touch number to *Call Groups 3, 16 and 27*, the LCD shows:

```
02:Group No.
3,16,27_
```

Helpful tip: To assign this number to all 32 call groups, enter *0* (zero).

- 13** Press **ENTER**.
The LCD will display the next empty one-touch number.
If you want to enter this one-touch number, go back to step 3.
If you *do not* want to enter any more one-touch numbers, press **STOP** to finish.
If you *do not* want to enter the *currently displayed* one-touch number but *do* want to enter *another* one-touch number, go back to step 2.

Use the autodialer labels in your fax's packaging to write down the stored numbers for easy reference.

Erasing a one-touch number

- 1** Press **Program key, A, 1, 0, 2, ENTER**. The LCD shows the one-touch number you have already entered:

```
Select One-Touch
01:9-1-555-345-6789
```

Note: If the one-touch number that appears is other than **01**, it means that **01** is empty.

- 2** Press the key for the one-touch number you want to erase.
Here, we've selected **02**:

```
Select One-Touch
02:9-1-555-987-6543
```

- 3** If you want to erase a number stored in a different one-touch key than what appears on the LCD, press that key now.

- 4** Press **ENTER**. The LCD shows:

```
02:Erase One-Touch
Check Enter/Cancel
```

Important: If you want to quit without erasing the one-touch number you've selected, press **CANCEL**. The fax will return to step 2.

- 5** Press **ENTER** to erase the number.

```
Erase One-Touch
** Complete **
```

To erase another one-touch number, repeat steps 2-5. Or press **STOP** to return to standby mode.

Printing a list of one-touch numbers

Forgot which number is stored in which one-touch key? Just print a list of your one-touch numbers. The list includes each key's number, the Location ID (if any), fax/telephone number and group number(s) you've stored in the key.

To print a list of one-touch numbers, press **Program key, E, 1, 0, 6, ENTER**.

One-touch *fax* dialing

To dial a *fax* call using a one-touch number:

- 1 Place the the document in the ADF, or on the FBS glass.
- 2 If you are using the FBS glass, enter the document size by pressing the **DOCUMENT SIZE**.
- 3 Adjust resolution and contrast if necessary.
- 4 Press the one-touch key in which you ve stored the number.

What happens next depends on whether you specified memory transmission or real time transmission:

If you specified Quick Memory transmission:

Your fax machine scans the first page of your document into memory, then dials the other fax machine.

While dialing, your machine scans the other documents into memory.

The LCD shows the Location ID and the document s width and resolution settings:

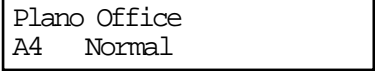

Plano Office
A4 Normal

Note: If the entry doesn t have a Location ID, the number appears.

When the other machine answers, your fax transmits the scanned document directly from memory. (To review Quick memory transmission, see page 2.3.)

If you specified normal memory transmission:

Your fax machine scans your entire document into memory first, then dials the other fax machine.

The LCD shows the Location ID and the document s width and resolution settings:

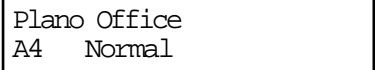

Plano Office
A4 Normal

Note: If the entry doesn t have a Location ID, the number appears.

When the other machine answers, your fax transmits the document directly from memory. (To review Memory transmission, see page 2.3.)

If you specified real time transmission:

Your fax machine dials the other fax machine.

The LCD shows the Location ID and the document s width and resolution settings:



Plano Office
A4 Normal

Note: If the entry doesn t have a Location ID, the number appears.

When the other machine answers, your fax feeds the document through its scanner, transmitting as it goes. (To review Real time transmission, see page 2.3.)

One-touch *phone* dialing

To dial a *phone* call using a one-touch number, you *must* have an optional handset attached to your machine. (Contact your authorized Muratec dealer to order an optional handset.)

To make the call:

- 1 Obtain a dial tone by doing one of the following:
 - Lift the handset
 - Press **MONITOR/CALL** to use the monitor speaker
- 2 Press the one-touch key in which you ve stored the number. As the machine dials, it shows the number on the LCD:

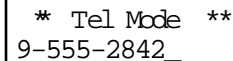

* Tel Mode **
9-555-2842_

Note: Remember that your fax machine s monitor speaker is *not* a speaker *phone*. If you dialed by using the monitor speaker, pick up the handset to speak to the person that answers.

Note: If the call fails, and you used **MONITOR/CALL** to dial, press **MONITOR/CALL** to hang up.

Using speed-dial numbers

Your fax machine will store up to 145 speed-dial numbers, designated by three-digit identifier codes from 001 through 145.

Entering or changing a speed-dial number

- 1** Press **Program key, A, 2, 0, 1, ENTER**. The LCD shows an empty speed-dial number:

Enter Speed-Dial No.
001:No Number Stored

Note: If a speed-dial number other than **001** appears on the LCD, it means you have already entered a number for **001**.

- 2** Use the numeric keypad to enter the desired speed-dial number's three-digit identifier code. Here, we've entered 005 and the LCD shows either:

Enter Speed-Dial No.
005:No Number Stored

or

Enter Speed-Dial No.
005:9-555-397-0123

Important: When entering the identifier code for speed-dial numbers less than 100, you must enter leading zeros to make three digits. For example, 001-099.

- 3** If you want to select a different speed-dial number, press that number's three-digit identifier code now. That number appears on the LCD.
- 4** Press **ENTER**. Depending on whether you already have a number entered for this speed-dial number, the LCD now shows either:

005:Fax Number
_

or

005:Fax Number
9-555-397-0123_

- 5** Use the numeric keypad to enter the number *exactly* as your machine should dial it, including whatever access codes your phone system requires. (You may want to review *Special dialing characters*, page 3.1.) The number can be up to 40 characters in length:

005:Fax Number
9-1-555-567-1234_

Your display can show only 20 characters at a time. To view characters beyond those 20, press **◀** to scroll to the left or **▶** to scroll to the right.

- 6** When the number appears as you want it, press **ENTER** to store it.

- 7** The LCD now displays either:

005:Alt. No.
_

or

005:Alt. No.
9-1-555-789-3556_

You now have the option to enter (or change) an *alternative* number. Your fax machine will dial this alternative number during a transmission after all redial attempts to the regular number fail. If the alternative number also fails, the fax alarm beeps to alert you to a problem.

Note: You can enter one alternative number for one speed-dial or one-touch number you entered. Your fax holds a maximum of 10 alternative numbers in all, that is, only 10 speed-dials or one-touch numbers can have the alternative number. After you have entered the alternative numbers for 10 speed-dials or one-touch numbers, your machine will no longer show this display.

If you *do* want to enter (or change) an alternative number, enter it now.

This number can be up to 40 characters long.

If you *do not* want to enter or change an alternative number, go on to step 8.

- 8** Press **ENTER**.

- 9** The LCD now shows:

005:Name ;Upper
_

or

005:Name ;Lower
West Coast Sales_

The machine is now prompting you for a name a Location ID so you'll be able to find it in the EasyDial directory (see page 3.9).

If you *do* want to enter or change this number's Location ID, go on to step 10.

If you *don't* want to enter or change this number's Location ID, skip to step 11.

- 10** Enter the Location ID by using the one-touch keys. (If necessary, review *Entering characters*, page 1.12) A number's Location ID may be up to 24 characters in length.

- 11** Press **ENTER** to save the setting and continue.

- 12** The LCD now shows:

005:Group No.
_

or

005:Group No.
1,4,12_

You may now assign this number to up to 32 call groups. (If necessary, review *Call groups*, page 3.8.)

If you *do* want to enter or change the call group number, go on to step 13.

If you *do not* want to enter or change this number's call group, skip to step 14.

- 13** Use the numeric keypad to enter the call groups for this number. There are 32 possible call groups, numbered 1-32.

Here, we've entered **6** to assign this speed-dial number to *Call Group 6*:

```
005:Group No.  
6_
```

If you want to assign the number to more than one call group, insert a *comma* after each number (except the last one) by pressing **GROUP**.

Here, we've entered **6, GROUP, 1, 7, GROUP, 3, 0** to assign this speed-dial number to *Call Groups 6, 17 and 30*:

```
005:Group No.  
6,17,30_
```

Helpful tip: To assign this number to all 32 call groups, enter *0* (zero).

- 14** Press **ENTER**.

The LCD will display the next empty speed-dial number.

If you want to enter this speed-dial number, go back to step 4.

If you *do not* want to enter any more speed-dial numbers, press **STOP** to finish.

If you *do not* want to enter the *currently displayed* speed-dial number but *do* want to enter *another* speed-dial number, go back to step 2.

Erasing a speed-dial number

- 1** Press **Program key, A, 2, 0, 2, ENTER**. The LCD shows the speed-dial number you have already entered:

```
Enter Speed-Dial No.  
001:9-555-584-6950
```

Note: If the speed-dial number that appears is other than **001**, it means that **001** is empty.

- 2** Use the numeric keypad to enter the three-digit identifier for the speed-dial number you want to erase. Here, we've selected *005*:

```
Enter Speed-Dial No.  
005:9-1-555-987-6543
```

- 3** If you want to erase a different speed-dial number than the one that appears on the LCD, enter that number now.

- 4** Press **ENTER**. The LCD shows:

```
005:Erase Speed-Dial  
Check Enter/Cancel
```

Note: If you want to quit without erasing the speed-dial number you've selected, press **CANCEL**. The fax will return to step 2.

- 5** Press **ENTER** to erase the number.

```
Erase Speed-Dial  
** Complete **
```

To erase another speed-dial number, repeat steps 2-5. Or press **STOP** to return to standby mode.

Printing a list of speed-dial numbers

You can easily print a list of your speed-dial numbers. The list includes each number's three-digit identifier, the Location ID (if any), number and any group numbers you've stored for that speed-dial number.

To print a list of speed-dial numbers, press **Program key, E, 1, 0, 7, ENTER**.

Fax dialing via speed-dial

To dial a *fax* call using a speed-dial number:

- 1 Place the document in the ADF, or on the FBS glass.
- 2 If you are using the FBS glass, enter the document size by pressing the **DOCUMENT SIZE**.
- 3 Adjust resolution and contrast if necessary.
- 4 Press **SPEED DIAL/TEL INDEX**. The LCD shows:

```
Enter Speed-Dial No.
S_
```

- 5 Use the numeric keypad to enter the three-digit identifier (such as *018*, in this example) for the speed-dial number you want to dial. The LCD shows the Location ID (or fax number) you stored:

```
Plano Office
S018_
```

- 6 Press **START**.

What happens next depends on whether you specified memory transmission or real time transmission:

If you specified quick memory transmission:

Your fax machine scans the first page of your document into memory, then dials the other fax machine.

While dialing, your machine scans the other documents into memory.

The LCD shows the Location ID and the document's width and resolution settings:

```
Plano Office
A4 Normal
```

Note: If the entry doesn't have a Location ID, the number appears.

When the other machine answers, your fax transmits the scanned document directly from memory. (To review Quick memory transmission, see page 2.3.)

If you specified normal memory transmission:

Your fax machine scans your entire document into memory, then dials the other fax machine.

The LCD shows the Location ID and the document's width and resolution settings:

```
Plano Office
A4 Normal
```

Note: If the speed-dial entry doesn't have a Location ID, the number appears. When the other machine answers, your fax will transmit the document directly from memory. (To review Memory transmission, see page 2.3.)

If you specified real time transmission:

Your fax machine dials the other fax machine.

The LCD shows the Location ID and the document's width and resolution settings:

```
Plano Office
A4 Normal
```

Note: If the speed-dial number doesn't have a Location ID, the number appears. When the other machine answers, your fax feeds the document through its scanner, transmitting as it goes. (To review the Real time transmission, see page 2.3.)

Phoning via speed-dial

To dial a *phone* call using a speed-dial number, you *must* have an optional handset attached to your machine. To make the call:

- 1 Obtain a dial tone by doing one of the following:
 - Lift the handset
 - Press **MONITOR/CALL** to use the monitor speaker
- 2 Press **SPEED DIAL/TEL INDEX**. The LCD shows:

```
** Tel Mode **
S_
```

- 3 Use the numeric keypad to enter the three-digit identifier for the speed-dial number you want to dial. As the machine dials, it shows the number on the LCD:

```
** Tel Mode **
9-555-5783_
```

Note: Remember that your fax machine's monitor speaker is *not* a speakerphone. If you dialed using the monitor speaker, pick up the handset to speak to the person that answers!

Note: If the call fails, and you used **MONITOR/CALL** to dial, press **MONITOR/CALL** to hang up.

Call group dialing

If you frequently send the same fax message to more than one location, store the group number into the one-touch key or speed-dial number. (If necessary, see Using a one-touch keys and Using speed-dial numbers , in previous page.)

After you store the group number, you can send the same fax to many different locations using **GROUP** key.

Send a fax via call group

Note: The call group dialing can be used only with memory transmission.

- 1** Place the document in the ADF, or on the FBS glass. And adjust resolution and contrast if necessary.
- 2** If you are using the FBS glass, enter the document size by pressing the **DOCUMENT SIZE**.
- 3** Press **GROUP**.

Enter Group No. G_

- 4** Use the numeric keypad to enter the group number you want to send a fax.

Note: If you want to send a fax to several groups at a time, press **BROADCAST** then repeat steps 2 3. Also, you can include the one-touch location, speed-dial location and up to 30 manually dialed number. (See Broadcasting, page 3.10.)
- 5** Press **START**.

Printing a call group directory

Your machine can also print a *call group directory*. This lists all your stored autodialer numbers by Location ID and lists the groups to which these numbers belong.

The directory divides the call groups into four banks, 01 09 (the list shows 00), 10 19 (the list shows 10), 20 29 (the list shows 20) and 30 32 (the list shows 30). If you specify call group 0 (which puts the number in all call groups), the directory shows all numbers (see right column).

For example, the directory might show:

No.	Location	00	10	20	30
[01]	Carson Co	4	0 4		
[02]	Tex. Ofc.	1			
[03]	e.e.gummi			0	2
S001	And Sew I	2 4			
S002	KC Enterp		7 0	1	
S003	Katz Cat	1 2 3 4 5 6 7 8 9	0 1 2 3 4 5 6 7 8 9	0 1 2 3 4 5 6 7 8 9	0 1 2

In this list, one-touch number 01 (*/01*) is in groups 4, 10 and 14; one-touch number 02 (*/02*) is in group 1; one-touch number 03 (*/03*) is in groups 20 and 32; speed-dial number 001 (*S001*) is in call groups 2 and 4; speed-dial number 002 (*S002*) is in groups 7, 10 and 21; and speed-dial number 003 (*S003*) is in all groups, 1 to 32.

To print a call group directory, press **Program key, E, 1, 0, 9, ENTER**.

EasyDial directory dialing

EasyDial directory dialing makes your autodialer even more like an electronic phone book. EasyDial sorts and displays numbers alphabetically according to their Location IDs, so you can find them and dial them easily.

To dial using EasyDial:

- 1 For a regular phone call: Pick up the optional handset.

Note: To make a regular phone call from your machine, you must have an optional handset attached.

For a fax call: Place the document in ADF, or on the FBS glass. And adjust resolution and contrast if necessary.

- 2 Press **SPEED DIAL/TEL INDEX** twice. The LCD shows the *first* listing in your fax machine's EasyDial directory:

```
Telephone Index [A]
ABC Company    : [01]
```

The EasyDial directory sorts entries alphabetically in the following order: (1) by alphabet, (2) by number and (3) by symbol.

If the listing that appears is the one you want to dial, skip to step 4. Otherwise, proceed to next step.

- 3 Scroll through the listings to find the one you want. You do this by pressing the following cursor key:

▲ or ▼ to select the character set alphabet, number or symbol for the *first* character of the Location ID.

◀ or ▶ to check different listings within that character set.

Note: The scrolling is open-ended. For example, when you run out of listings beginning with alphabet A, pressing ◀ or ▶ automatically moves you into listings beginning with other characters.

- 4 When the LCD displays the name you want to dial, press **START**.

If you've set the document in the ADF, your machine will start the fax transmission.

If you've set the document on the FBS glass, enter your document size by pressing **DOCUMENT SIZE**, then press **START**. Your machine will start the fax transmission.

If you make a regular phone call, speak after a person answered.

If an EasyDial call fails

If an EasyDial call fails, what happens next depends upon the kind of call it was.

If it was a fax call

Your fax machine automatically redials the number according to the redial interval you've set. It keeps trying until either of the following occurs:

It successfully reaches the other number

It has attempted the number of redials programmed and has still not connected (see *Changing redial settings*, page 4.5).

If it was a regular phone call

You'll have to redial manually:

- 1 Lifting the optional handset.
- 2 Press **REDIAL/PAUSE**. The LCD will show:

```
View Redial History
0:1234567890
```

- 3 Your machine can remember the last 10 dial numbers you've dialed. Press ◀ or ▶ until the dial number you want to redial appears.
- 4 Press **START**.

Broadcasting

The fastest way to fax *one* document to *many* recipients is to *broadcast* it.

In an ordinary broadcast, you send the fax as you normally would, except you just add more fax numbers. You can enter up to 230 numbers:

30 manually-dialed numbers **AND**

200 autodialer numbers **OR** 1 call group with all 200 autodialer numbers

You can broadcast using any function that requires a fax number to be entered. That means you can send a *delayed* broadcast, program a *polling* broadcast and even broadcast to hub units for F-Code *relay broadcast initiation*. All of these are explained in this chapter.

To send a broadcast fax:

- 1 Insert the document and make any necessary adjustments as you would for a regular fax transmission.
- 2 Press **BROADCAST**.
- 3 Enter the *first* fax number, as usual. Use either a one-touch number, a speed-dial number, a call group or a regular number dialed from the numeric keypad.
- 4 To add more fax numbers, press **BROADCAST** between each one to insert a *comma*. Then enter the number as described in step 3 (pressing **GROUP** inserts its own comma). You can send to up to 230 numbers for a broadcast.

```
Press Start  
[03],S098,G12,9-555_
```

Important: Do **not** insert a comma after the *last* fax number.

Note: If you enter characters by mistake, press **CANCEL** to erase them.

- 5 Press **START**. Your fax machine scans the document into memory and then sends it to each number or call group you've entered.

Delayed broadcasting

What if you want the broadcast to take place later? That's the purpose of setting up a *delayed broadcast*.

Note: Delayed commands are discussed on pages 2.8 and 2.9. And you may want to read *Delayed transmission* on page 3.11 before proceeding.

- 1 Follow steps 1-4 of *Broadcasting basics* (left column).
- 2 Press **ADVANCED FUNCTIONS, ENTER**.
- 3 Use the numeric keypad to enter the day of the month and time (in 24-hour format) when you want the broadcast to occur. Here, we've scheduled it for 10:15 PM on the 30th.

```
Delayed  
Enter Time: 30/22:15
```

- 4 Press **ENTER** to save the setting.
- 5 Press **START**. Your machine will scan your document into the memory and return to standby mode, while showing this on the LCD:

```
** Reserved **  
Jun 01 2000 17:17
```

This means your fax machine is reserved for the delayed broadcast you just programmed, but it can still be used to send and receive faxes if your broadcast document is stored in memory.

Making changes to broadcasts

If you need to make changes in a broadcast after setting it up, use the **REVIEW COMMANDS** function. See *Reviewing or canceling parts of a broadcast*, page 2.8.

Delayed transmission

Take advantage of lower evening and weekend long-distance rates with *delayed transmission*. Your fax machine can store up to 99 delayed commands, each of which you can program up to 31 days in advance.

Important: If you program all 99 delayed transmission commands, no further *memory* transmission is possible until one or more of the commands is completed. (To review Memory transmission, see page 2.3.) However, if all 99 delayed commands are programmed, you can always transmit with the Real time transmission from ADF (see page 2.3).

Setting up a delayed transmission

Important: Your machine only remembers the *day* of the month that it's supposed to send a delayed transmission. It does not remember the month itself. So if you want to send a transmission at 5:05 PM on **June 26**, don't program the transmission sooner than 5:06 PM on **May 26**.

To set up a delayed transmission:

1 Insert the document and make any necessary adjustments.

2 Press **ADVANCED FUNCTIONS**. The LCD shows:

```
1.Delayed
  ←/→/Enter
```

3 Press **ENTER**. The LCD shows the current day of the month, followed by the current time (in 24-hour format):

```
Delayed
Enter Time: 06/17:16
```

4 Use the numeric keypad to enter the day of the month and the time when you want the fax to send the delayed transmission.

Note: Press ◀ to move the cursor left, or ▶ to move it right.

Here, we've set the transmission to occur on the 11th at 11:05 PM:

```
Delayed
Enter Time: 11/23:05
```

5 When the date and time are entered, press **ENTER** to save the delayed transmission. The LCD shows:

```
Enter Fax Number
_
```

6 Enter the fax number for the delayed transmission document. You can either press a one-touch key, enter a speed-dial number or use the numeric keypad to enter the fax number.

7 Press **START**. Your machine returns to standby mode, while showing this on the LCD:

```
** Reserved **
Jan 29 2000 17:17
```

This means your fax machine is reserved for the delayed transmission you just programmed.

If you set the machine for *memory transmission*, it will scan the document into memory, after which you can use the machine normally.

If you set the machine for *non-memory transmission (real time transmission)*, the machine can *receive* faxes but can't *transmit* until your delayed command has been performed.

Important: If you specified the delayed non-memory transmission (real time transmission), do not remove the document in ADF. If the document is removed from ADF before a delayed command completes, it cancels the delayed real time transmission.

Batch transmission

Batch transmission allows you to store multiple documents in an electronic basket throughout the day and then fax that entire basket to *one* location.

To do this, just tell the machine when and where the transmission should go. When that date and time arrives, your machine will transmit each document in the batch box to the remote fax machine. You can store up to 40 documents (each document can include one page or many pages) into your machine's five electronic *batch boxes*.

Creating or modifying a batch box

Before sending a batch transmission, you have to create batch boxes in your fax machine. The steps below also let you modify existing batch boxes.

To create or modify a batch box:

- 1** Press **Program key, c, 5, 0, 1, ENTER**. Depending on whether you already have a number entered for batch box *1*, the LCD shows:

Select Batch Box
1:No Number Stored

or

Select Batch Box
1:9-1-555-345-6789

- 2** Use the numeric keypad to enter the number (*1-5*) of the batch box you want to create or modify. Here, we've pressed **3** and see either:

Select Batch Box
3:No Number Stored

or

Select Batch Box
3:9-555-2110

- 3** If you want to select a different batch box than the one displayed on the LCD, use the numeric keypad to enter the batch box number now.

- 4** Press **ENTER**. The LCD now shows either:

3:Fax Number
_

or

3:Fax Number
9-555-2110_

- 5** Use the numeric keypad to enter the fax number *exactly* as your machine should dial it, including whatever access codes your phone system requires. (You may want to review Special dialing characters, page 3.1.) The number can be up to 40 characters in length:

3:Fax Number
9-1-555-871-9052_

Your display can show only 20 characters at a time. To view characters beyond those 20, press ◀ to scroll to the left or ▶ to scroll to the right.

- 6** When the number appears as you want it, press **ENTER**. The LCD now shows:

3:Transmit Time
Enter Time: 26/14:00

- 7** Instruct your fax to send from this batch box in *one* of the following ways:

- Option 1:** *Once* at a certain time on a certain day of the month (*For example: Do this at 5:05 PM on the 30th.*) Use the numeric keypad to enter the date and time (*24-hour format*) the machine should send the documents from the batch box:

3:Transmit Time
Enter Time: 30/17:05

- Option 2:** At a certain time *each day* you press the key (*For example: Do this at 5:05 PM today.*) Use the numeric keypad to enter **0, 0 (00)**, and then the time when the fax should send the documents from the batch box:

3:Transmit Time
Enter Time: 00/17:05

Note: To change a digit in the date or the time, press ◀ to move the cursor left or ▶ to move it right. Then enter the correct number.

- 8** When the date and time are set, press **ENTER**.

- 9** The LCD now shows:

3:Name ;Upper
_

or

3:Name ;Lower
Bookkeeping_

The machine now asks you to name this batch box.

If you *do not* want to enter or change this batch box's name, skip to step 11.

- 10** Enter the name by using the one-touch keys. (If necessary, review Entering characters, page 1.12) A batch box's name may be up to 24 characters in length.

11 Press **ENTER** to save the batch box information.

To create or modify another batch box, repeat steps 2-11.
To finish, press stop.

Printing a list of batch boxes

You can easily print a list of your batch boxes. The list includes each box's identifier number, the Location ID, fax number and date/time the transmission should start. To print the list, press **Program key, E, 1, 1, 5, ENTER**.

Storing a document for batch transmission

Your fax machine can store up to 40 *documents* (each document can include one page or many pages) in each batch box until the date and time you designate the batch transmission to take place. Once the batch documents are transmitted, they are automatically erased from the machine's memory.

Note: For this operation to work, two things must be true:

The batch box must exist on your fax machine.

You must know the batch box's one-digit number (1-5).

To store a document in a batch box for batch transmission:

- 1** Insert the document and make any necessary adjustments.
- 2** Press **ADVANCED FUNCTIONS** five times and then press **ENTER**. The LCD shows:

```
Batch Tx
Enter Box No.   :_
```

- 3** Use the numeric keypad to enter the one-digit number for the batch box you want to use. Here, we've entered **5** to indicate batch box 5.

```
Batch Tx
Enter Box No.   : 5
```

Note: *Tx* is a common abbreviation for *transmission*.

- 4** Press **ENTER**. The LCD shows:

```
Press Start
Box :5 File : 1
```

Important: Your machine gives each document in a batch box a *file number*, shown as *1* above. You will need to know this file number should you later wish to erase or print the stored document. Each batch box holds up to 40 files (1-40).

- 5** Press **START**. The machine displays **Reserved** on the top line of the LCD. This means the document is stored in memory.

Printing a list of stored batch documents

You can print a list of the documents stored in your machine's batch boxes. This list provides you with the documents' file numbers so you can erase or print them as needed.

To print the list, press **Program key, E, 1, 1, 6, ENTER**.

Printing a document stored in a batch box

To print a document stored in a batch box:

- 1** Press **Program key, D, 3, 0, 3, ENTER**. The LCD shows:

```
Batch Document
Enter Box No.   :_
```

- 2** Use the numeric keypad to enter the number (1-5) of the batch box storing the document you want to print. Here, we've entered **1** to indicate batch box 1.

- 3** Press **ENTER**. The LCD shows:

```
1:Batch Document
Enter File No.  :_
```

- 4** Use the numeric keypad to enter the document's file number (1-40).

- 5** Press **ENTER**.

Your fax machine prints the document, then returns to standby mode.

Erasing a document stored in a batch box

To erase a document stored in a batch box on your fax machine:

- 1 Press **Program key, D, 2, 0, 3, ENTER**. The LCD shows:

```
Batch Document
Enter Box No.   :_
```

- 2 Use the numeric keypad to enter the number (1-5) of the batch box storing the document you want to erase. Here, we've entered 1 to indicate batch box 1.

- 3 Press **ENTER**. The LCD shows:

```
1:Batch Document
Enter File No.  :_
```

- 4 Use the numeric keypad to enter the document's file number (1-40).

- 5 Press **ENTER**. The fax machine now gives you one last chance to change your mind before erasing the document.

```
1:Batch Document
Check Enter/Stop
```

Important: To quit the operation without erasing this or any document, press **STOP**. The machine returns to standby mode.

- 6 Press **ENTER**. The fax machine erases the document you've chosen, then returns to standby mode.

Erasing an empty batch box

Batch boxes must be empty to be erased. If a box has documents stored in it, then you first have to erase those documents. See left column.

To erase an empty batch box:

- 1 Press **Program key, C, 5, 0, 2, ENTER**. The LCD shows:

```
Select Batch Box
1:No Number Stored
```

or

```
Select Batch Box
1:9-5551023
```

- 2 Use the numeric keypad to enter the number (1-5) of the batch box you want to erase. Here, we've pressed 2 and see:

```
Select Batch Box
2:9-1-972-5559900
```

- 3 If you want to erase a different batch box than what appears on the LCD, enter that batch box's number now.

- 4 Press **ENTER**. If the batch box is empty, the LCD shows:

```
2:Erace Batch Box
Check Enter/Cancel
```

Important: If you select a batch box which is *not* empty, the machine beeps and briefly shows:

```
Select Batch Box
Document Stored
```

Erase any documents stored in the batch box (see left column), then go back to step 3.

Important: If you want to quit without erasing the batch box you've selected, press **CANCEL**. The fax will return to step 2.

Important: If you want to quit without erasing *any* batch box, press **STOP**. The machine returns to standby mode.

- 5 Press **ENTER** to erase the batch box.

```
Erace Batch Box
** Complete **
```

To erase another batch box, repeat steps 2-5. To finish, press **STOP**.

Polling

Polling allows someone to fax a document to you *without* having to make the call or pay for it. There are several kinds of polling:

Regular polling Your fax retrieves a document from a remote fax machine.

F-Code polling Your fax retrieves a document stored as a file in the remote fax machine. To do this, you must be communicating with another F-code-compatible fax machine. For more information on F-Code polling, see *F-Code communication*, pages 3.35.

Note: For polling to work, the remote machine must also be set up to *be polled*.

Regular polling

To set up your machine for regular polling:

- 1** Make sure the document is inserted in the remote fax machine.
- 2** Press **ADVANCED FUNCTIONS** *twice* and then press **ENTER**. The LCD shows:

Enter Fax Number
 _
- 3** Enter the remote fax machine's number by either pressing a one-touch key, entering a speed-dial number or using the numeric keypad.
- 4** To perform the regular polling *now*, skip to step 8.
To perform *delayed* regular polling, go on to step 5.
- 5** Press **ADVANCED FUNCTIONS, ENTER**. The LCD shows:

Delayed
 Enter Time: 15/17:05
- 6** Use the numeric keypad to enter the date and time (use the *24-hour format*) when your machine should perform the delayed regular polling.
- 7** Press **ENTER**.
- 8** Press **START**.

When your machine polls for documents, it dials the number and, upon making contact with the other machine, begins receiving the document as if the other machine had placed the call.

Being polled

Not only can you poll, but you can also *be* polled. To set up a document for regular polling:

- 1** If your fax machine is set for Tel Ready reception, change it to the reception mode except the Tel Ready.

Important: Your machine **can't** be polled if it's in Tel Ready mode.
- 2** Insert the document.
- 3** Adjust resolution and contrast if necessary. (Your fax machine will be transmitting to the machine doing the polling.)
- 4** Press **Program key, D, 1, 0, 1, ENTER**.
Your fax will scan the document into memory and return to standby mode.

Once the remote fax machine polls the document you stored, your fax machine automatically erases the document from memory.

Printing a stored polling document

To print a document you've stored for regular polling *without erasing* it, press **Program key, D, 3, 0, 1, ENTER**.

Erasing a stored polling document

To erase a document you've stored for regular polling from your machine's memory, press **Program key, D, 2, 0, 1, ENTER**.

Limiting polling access to your fax machine

When you set the passcode, a calling fax which doesn't present the proper passcode cannot poll from your fax.

Important: The passcode you use for polling operation is **not** the same as the protection passcode (see page 3.50).

Advanced features

Note: If you re using the Block Junk Fax feature (see pages 3.54 3.55), even incoming calls which meet the passcode test must come from phone numbers you ve approved.

To set your fax machine s passcode:

1 Decide on the four-digit passcode (*0001 9999*) you want to use. **Write it down**, and *put it in a safe place*.

2 Press **Program key, B, 2, 1, 3, ENTER**. The LCD shows the current code:

Passcode
Passcode : 0000

3 Use the numeric keypad to enter the desired four-digit *passcode*.

Passcode
Passcode : 5627

4 Press **ENTER** to save the setting.

Note: To turn off the limiting polling, change the passcode to *0000* by repeating steps 1 4 and entering *0000* in step 3.

Special features

Your fax machine has numerous special features to make your communication easier. We'll cover them here.

Soft keys

Soft Keys are shortcut keys. You can program the soft keys on the control panel to turn on or off any function with just the touch of a button. Your machine has three Soft Keys. If the light above any one of these keys glows, that means the setting programmed into that key is active.

These keys are programmed at the factory to turn the following functions on or off:

Confirmation report (see page 3.22)

Memory transmission (see page 2.3)

Monitor / Call request (see pages 2.6 and 3.25)

Note: The keys that are programmed at the factory turn the functions above them on and off, but only for the next transmission that you send from your fax machine. Once that transmission is complete, your machine returns to its default setting.

But instead of using the Soft Keys to control the functions above, you can program them to turn other functions on or off. These functions are:

Energy saving (see page 4.9)

Fax & Copy (see page 3.21)

Send TTI (see pages 1.18 and 4.2)

Security reception (see page 3.50)

Cover page (see page 3.23)

Sort copy (see pages 2.13 and 2.16)

Negative / Positive copy (see page 2.16)

Combine (only for MFX-1600) (see page 2.17)

Copy / Fax mode (see page 1.11)

Note: And instead of just turning the function on or off for the next transmission, as the factory-set keys do, changing the Soft Key settings actually sets the default for your fax machine. (These default settings can be changed, if necessary. They are not permanent.)

Setting the Soft Key

1 Press **Program key, B, 1, 0, 3, ENTER**. The LCD shows:

```
Select Soft Key No.
1:Report
```

... or indicates another function you've stored into this key.

2 Press **◀** or **▶** until the Soft Key (1-3) you want to change appears. In this example, we've chosen **3**.

3 Press **ENTER**. The LCD shows:

```
3:Monitor/Call
←/→/Enter
```

4 Press **◀** or **▶** until the function appears that you want to program into the key. In this example, we've chosen *Cover page*.

```
3:Cover Page
←/→/Enter
```

5 Press **ENTER** to save the setting. The LCD will display the next Soft Key. If you do want to set this Soft Key, go back step 3. If you do not want to set the currently displayed Soft Key but do want to set another Soft Key, go back to step 2. If you do not want to set any more Soft Keys, press **STOP** to finish.

Now you can use the labels included in your machine's original packaging to label the Soft Key function you just set.

Macro keys

If you perform the same operation repeatedly, you can automate the operation using a macro. A macro is a series of the several steps that you group together as a single command to accomplish the operation automatically.

A macro key faithfully records up to 60 steps that you performed to teach the macro. You can teach the Macro keys to carry out any of the following jobs, but you cannot teach the operation regarding the machine settings.

Note: One Macro key can hold only one job. It cannot combine two or more jobs.

Copy:

All copy settings

Printouts:

- Machine settings list (page 4.10)
- Fax settings list (page 4.10)
- Copy settings list (page 4.10)
- Activity journal (page 3.22)
- Delayed commands list (page 2.9)
- Delayed commands documents (page 2.9)
- One-touch list (page 3.3)
- Speed-dial list (page 3.6)
- Programmable one-touch numbers list (page 3.49)
- Call group directory (page 3.8)
- Blocked numbers list (page 3.55)
- Sample cover page (page 3.24)
- Department time list (page 3.57)
- List of F-Code boxes (page 3.30)
- List of documents stored in F-Code boxes (page 3.30)
- Batch transmission documents (page 3.13)
- Batch box list (page 3.13)
- List of stored batch documents (page 3.13)
- F-Code Box (bulletin box) documents (page 3.31)
- Macros list (page 3.20)
- Stored polling documents (page 3.15)
- Security receive documents (page 3.51)

Document storage:

- Regular polling documents (page 3.15)
- F-Code polling documents (pages 3.30 3.31)

Communications functions:

- Delayed transmission (explained on pages 3.11)
- Broadcasting (page 3.10)
- Regular polling (pages 3.15 3.16)
- Batch transmission (pages 3.12 3.14)
- F-Code transmission (page 3.34)
- F-Code polling (page 3.35)

Programming the Macro key

1 Press **MACRO PROGRAM**, **ENTER**. The LCD shows:

```
Select Macro Key
M1:No Number Stored
```

2 Press the Macro key (**M1** or **M2**) you want to program or change. In this example, we've chosen **M2**.

```
Select Macro Key
M2:No Number Stored
```

3 Press **ENTER**. If you chose the key already programmed, proceed to step 4. Otherwise, skip to step 5.

4 The LCD shows:

```
Overwrite?
Check Enter/Cancel
```

If you want to overwrite the operation already programmed, press **ENTER**. If you want to overwrite only the job's name, press **CANCEL** and go to step 9. If you *do not* want to overwrite the key you have choice, press **STOP**.

5 The LCD of stand-by mode appears, which means the machine is ready to register the steps into the Macro key.

```
Fax Ready
Jun 1 2000 13:30
```

Note: It keeps beeping during the job registration in order to make notice of the registration mode.

6 Press the keys exactly as you operate the job you want to program into the Macro key.

Note: You can program up to 60 steps. When it comes over 60 steps, your fax machine asks if you register the operations you have entered. If you want to register them, press **ENTER**. If not, press **STOP**.

Note: If you want to cancel the operations you have set, press **MACRO PROGRAM**, **STOP** and then go back to step 1.

Example 1: To program some operations for copy: Press **COPY/FAX** to change the copy mode, and set number of the copies, paper size, contrast, resolution, reduction/enlargement rate and sort setting as you want.

Note: See Making copies (pages 2.12 2.18) for detail operations.

Example 2: To program the operations for printing the one-touch numbers list: Press **Program key**, **E**, **1**, **0**, **6**, **ENTER**.

7 If you programmed **ENTER** or **START** into the operation, proceed to step 8. Otherwise, press **MACRO PROGRAM** and skip to step 9.

8 If you want to start immediately after pressing the Macro key when you use it, press **ENTER**. If not, press **CANCEL**.

Note: If you want to confirm the settings or operations in the Macro key before you start it, press **CANCEL** here.

Include Start/Enter?
Check Enter/Cancel

9 The LCD now shows:

M2:Name ;Upper
_

or

M2: Name ;Upper
Delayed_

The machine now asks you to name this job.

If you *do not* want to enter or change this job's name, skip to step 11.

10 Enter the name by using the one-touch keys. (If necessary, review Entering characters, page 1.12) A job's name may be up to 130 characters in length.

11 Press **ENTER** to save the setting.

Copying with the Macro key

To copy using a Macro key:

- 1** Insert the document.
- 2** Press the **Macro key** in which you've stored the copy command.
- 3** Press **START**, if you have not registered **START** in the Macro key.

Printing lists using the Macro key

To print a list using a Macro key:

- 1** Press the **Macro key** in which is programmed for the printing lists.
- 2** Press **ENTER**, if you have not registered **ENTER** in the Macro key.

Storing fax documents with the Macro key

To store a fax document for either polling or F-Code polling using a Macro key:

- 1** Insert the document.
- 2** Press the **Macro key** which is programmed for the storing operation you want to use.
- 3** Press **ENTER**, if you have not registered **ENTER** in the Macro key.

Fax dialing with the Macro key

To dial a fax call using a Macro key:

- 1** Insert the document.
- 2** Press the **Macro key** in which you've stored the fax communication command.
- 3** Press **START**, if you have not registered **START** in the Macro key.

Your fax will perform the operation now, or at whatever time you programmed.

If you programmed this key to delay its operation, the LCD shows:

** Reserved **
Jan 29 2000 17:17

If you programmed this key to perform the operation immediately after you press it, the LCD shows the number:

9-1-972-555-4335
A4 Normal

Erasing a Macro key

- 1** Press **MACRO PROGRAM** twice, **ENTER**. The LCD shows:

```
Select Macro Key
M1:Activity journal
```

- 2** Press the Macro key (**M1** or **M2**) you want to erase. Here, we've chosen **M2**.

```
Select Macro Key
M2:Batch box list
```

- 3** Press **ENTER**. The LCD shows:

```
Erase Macro
Check Enter/Cancel
```

Important: If you want to quit without erasing the Macro key you've selected, press **CANCEL**. The machine will return to step 2.

- 4** Press **ENTER** to erase the job.

```
Erase Macro
** Complete **
```

To erase another Macro key, repeat steps 2-4. Or press **STOP** to return to standby mode.

Printing a list of your Macro keys

Your fax machine can print a list of the Macro keys.

The list includes:

- (1) each key's Macro key number
- (2) the name of the job stored in the Macro key

To print a list of Macro keys, press **Program key, E, 1, 1, 7, ENTER**.

Setting the speed for Macros

You can adjust the speed of one step in the Macro key.

- 1** Press **MACRO PROGRAM** three times, **ENTER**. The LCD shows:

```
Macro Speed :Norm
←/→/Enter
```

- 2** Press **←** or **→** until the mode you want appears. The possible settings are:

```
Macro Speed :Norm
←/→/Enter
```

```
Macro Speed :Slow
←/→/Enter
```

```
Macro Speed :Fast
←/→/Enter
```

- 3** Press **ENTER** to save the setting.

Fax & Copy

With the Fax & Copy feature turned on, your machine asks if you want to make a copy of a document each time it transmits that document from memory.

Note: The Fax & Copy function cannot be used for real time transmission, and when the copy protection feature is set to on.

Note: Quick Memory transmission (see page 2.3) and the Fax & Copy function cannot be used at the same time. If both are turned on, Quick Memory will not work.

Note: The Fax & Copy feature will use the same resolution you set for the transmission for the copy's scanning resolution.

Setting the Fax & Copy function

- 1 Press **Program key, B, 1, 0, 6, ENTER**.

```
Fax & Copy      :Off
  ←/→/Enter
```

- 2 Press **◀** or **▶** until the mode you want appears. In this example, we've chosen *On*.

```
Fax & Copy      :On
  ←/→/Enter
```

- 3 Press **ENTER** to save the setting.
- 4 Press **STOP** to return to standby mode.

Using the Fax & Copy function

- 1 Place the document and select resolution and contrast you require.

Note: With this function, you cannot select normal and halftone resolution.
- 2 Enter the fax number. Either press a one-touch key, enter a speed-dial number, call group number or use the numeric keypad to enter the fax number.

If you entered the fax number using a one-touch key, skip to step 4. Otherwise, go on to step 3.
- 3 Press **START**.
- 4 The LCD changes copy mode and asks the number of copies you want to make.

```
Fax & Copy      1
  Ltr [ Ltr ] 100%
```

- 5 Use the numeric keypad to enter the number of copies you want for each page in the document. Choose from 01 to 99 copies.

Note: If you want to quit without transmitting and copying the document, press **STOP**. The machine returns to standby mode.

- 6 Press **START** to begin the transmission and copying process.

Helpful tip: If you do not wish to make a copy, press **CANCEL** in step 4. The LCD will show:

```
Canceled Copying
  Start/Stop
```

To cancel the making copy, press **START**. The machine start transmission process without copying the document. If you press **STOP**, the machine return to step 4.

Setting the activity journal

Just as a checkbook records your daily financial transactions, your fax machine keeps an *activity journal* which records its 100 most recent fax transactions. The activity journal lists the following information for each transaction:

Assigned number, starting each day at 001

Remote location called

Resolution mode

Starting date and time

Duration, in minutes and seconds

Length, in number of pages

Department code (see page 3.56)

Result of the call If preceded by an asterisk (*), this signifies an ECM communication (see page 4.1)

Any special operations For example, a fax call made using an optional handset will appear as *Manual*

Your fax machine will print the activity journal automatically after 100 transactions. To toggle this automatic printing on or off:

- 1 Press **Program key, C, 1, 0, 1, ENTER**. The LCD shows:

```
Journal AutoPrt .:Off
  ←/→/Enter
```

- 2 Press ◀ or ▶ until the mode you want appears. Here, we've chosen *On*.

```
Journal AutoPrt. :On
← / → / Enter
```

- 3 Press ENTER to save the setting.

Printing an activity journal manually

To print an activity journal *immediately* without waiting for 100 transmissions to be completed, press **Program key, E, 1, 0, 4, ENTER**.

Setting the printing order of the activity journal

Your fax machine prints the activity journal for every fax transaction. For example, if your machine has to redial a call, it will list those redials on the journal.

If you want to list those activities in the order of their assigned numbers, you can change the printing order of the activity journal. To change the printing order:

- 1 Press **Program key, c, 1, 0, 2, ENTER**. The LCD shows:

```
Journal Line Up :Off
← / → / Enter
```

- 2 Press ◀ or ▶ until the mode you want appears.

If you want the activity journal to print in the order of assigned number, choose *On*.

Otherwise, the machine will list every fax transaction of the same command and same location.

Here, we've chosen *On*.

```
Journal Line Up :On
← / → / Enter
```

- 3 Press ENTER to save the setting.

Setting the reports: TCRs and RCRs

Your fax machine can print *reports* of transmissions and receptions.

There are two different reports: a *transmit confirmation report (TCR)* and a *receive confirmation report (RCR)*. You can receive a TCR after sending a fax to *any* Group 3 fax machine, but the RCR function works only when you send a fax to a compatible Muratec machine. (Consult your authorized Muratec dealer with any questions about such compatibility.) Choose the type of report you want, based on the fax machines to which you're transmitting.

What the reports tell you

TCR

The TCR lists the following information for each communication:

Date and time of the TCR's printout

Remote location called

Resolution mode

Starting date and time

Duration, in minutes and seconds

Length, in number of pages

Result of the call

Any special operations For example, a fax call made using an optional handset will appear as *Manual*

Sample of the document An image of the first page of the document

If an error occurs, the TCR tells you the remote location which was called, the *error code* and *error message* (see pages 5.9 5.11).

RCR

The RCR lists the following information for each communication:

Date and time

Remote location called

Assigned number, starting each day at *001*

Resolution mode

Duration, in minutes and seconds

Length, in number of pages

Result of the call Either *OK* or an *error code* (see pages 5.9 5.10)

To set the printing one of these reports:

- 1 Press **Program key, c, 1, 0, 3, ENTER**. The LCD shows:

```
T C R Selected
  ←/→/Enter
```

- 2 Press **◀** or **▶** until the setting you want appears. Here, we've chosen *RCR*.

```
R C R Selected
  ←/→/Enter
```

- 3 Press **ENTER** to save the setting. The LCD shows:

```
Auto Print      :Off
  ←/→/Enter
```

Your machine is asking if it should print the selected report automatically after every fax you send.

- 4 Press **◀** or **▶** until the setting you want appears. Here, we've chosen *On*.

```
Auto Print      :On
  ←/→/Enter
```

- 5 Press **ENTER** to save the setting.

To turn the confirmation report feature on or off for *only* the next fax transmission, press **REPORT**.

What happens next depends on the setting you chose:

If the light above the **REPORT** key glows, the fax machine will print the confirmation report automatically.

If the light above the **REPORT** key doesn't glow, the fax machine will not print a confirmation report.

After you send this transmission, your machine returns to the setting you chose in step 2, above.

Cover page

Your fax machine can store a *cover page* to send at the beginning of each outgoing fax. This page includes the current date and time, your Location ID and your fax number (as stored in the TTI) and a message of up to 40 characters in length. The information appears in a box similar to this:

```

Fax Message From:
      Jun  1 2000 14:00

      Name:           And Sew It Goes Co.
      Fax Number:    972-555-2009

      [We appreciate your business. Thank you!]
  
```

Turning the cover page on

- 1 Press **Program key, c, 2, 0, 1, ENTER**. The LCD shows:

```
Cover Page      :Off
  ←/→/Enter
```

- 2 To tell the fax machine it *should* send a cover page before each document you transmit, press **◀** or **▶** until *On* appears on the LCD.

```
Cover Page      :On
  ←/→/Enter
```

Note: To tell the machine not to send a cover page, press **◀** or **▶** until *Off* appears on the LCD and press **STOP**.

- 3 Press **ENTER** to save the setting.

Now the cover page feature is working but your message line (shown in the example as *We appreciate your business. Thank you!*) is blank. To enter that message, see *Entering the cover page message*, next page.

Entering the cover page message

- 1 Press **Program key, c, 2, 0, 2, ENTER**.
- 2 Use the one-touch keypad to enter a message for the cover page. Enter the message the same way you entered your fax name during EasyStart. The message can be up to 40 characters in length.
Important: As in EasyStart, enter letters and other non-numeric characters by using the one-touch keys.
- 3 When the message appears as you want it, press **ENTER** to save it.

Printing the cover page

To confirm that the cover page is set correctly, print a sample cover page from your fax machine. Press **Program key, E, 1, 1, ENTER**.

OneLine + distinctive ring detection

Many phone companies now offer their customers a special service which makes it possible for one phone line to do the work of two.

With this service, you physically still have one phone line, but, electronically, you have two phone *numbers*. Your phone recognizes these different numbers and rings differently for each one.

For example, this makes it easy for you to have both a business number and a home number on one phone line, so you can answer one with Jane Doe Consulting, and the other with Hello. This works because you can tell the difference between the distinctive *patterns* of the two rings.

Your fax machine is also smart enough to tell the difference between two different numbers that are ringing it. All you have to do is set up your machine for the *OneLine + distinctive ring detection (DRD) feature*.

In order to use OneLine + DRD, your phone company must set up your distinctive ring service. When it does, it will assign a *ring pattern*. For example, the standard telephone ring is 2 seconds on (ringing) and 4 seconds off (silent), after which it repeats itself.

Your fax has eight possible distinctive ring patterns for use with OneLine + DRD. One of them should work with your phone company's DRD service. This chart lists the patterns:

Pattern	One complete ring pattern (seconds)
A	0.8 on, 0.4 off, 0.8 on, 4.0 off
B	0.4 on, 0.2 off, 0.4 on, 0.2 off, 0.8 on, 4.0 off
C	0.3 on, 0.2 off, 1.0 on, 0.2 off, 0.3 on, 4.0 off
D	1.0 on, 0.5 off, 1.0 on, 3.5 off
E	0.5 on, 0.5 off, 0.5 on, 0.5 off, 1.0 on, 3.0 off
F	0.5 on, 0.5 off, 1.0 on, 0.5 off, 0.5 on, 3.0 off
G	0.4 on, 0.6 off, 0.4 on, 4.6 off
H	1.5 on, 0.5 off, 0.5 on, 3.5 off

For example: pattern c is 0.3 seconds ringing, 0.2 seconds silent, 1 second ringing, 0.2 seconds silent, 0.3 seconds ringing and 4 seconds silent. Then it goes back to the first 0.3-second ring and starts over.

To use DRD on your fax machine:

- 1 Contact your phone company to make sure it has set up DRD service for you. If possible, also find out which distinctive ring pattern the phone company has assigned you.
- 2 When your machine is MFX-1200, Press **Program key, B, 2, 1, 4, ENTER**.
When your machine is MFX-1600, Press **Program key, B, 2, 1, 5, ENTER**.
The LCD shows:

```
DRD           :Off
← / → / Enter
```

- 3 Press ◀ or ▶ until the mode you want appears.
Here, we've chosen *On*.

```
DRD           :On
← / → / Enter
```

- 4 Press **ENTER**.

```
Ring Pattern  :A
← / → / Enter
```

- 5 Press ◀ or ▶ until the pattern you want appears.
Here, we've chosen *C*.

```
Ring Pattern  :C
← / → / Enter
```

- 6 Press **ENTER** to set your machine to the displayed ring pattern.

Important: If your telephone company gives you only very general ring pattern specifications, *or* if you encounter a problem while using your machine's DRD feature, **please try ALL of the listed ring patterns**. If you still have a problem after trying **all** of the patterns, please call the Muratec Customer Support Center. (From the United States, call 800-347-3296.

Important: With your machine set for using DRD, it won't respond to any ring pattern other than the one you selected above. To reset the fax so it will respond once again to normal rings, repeat steps 2-4, above *except*, in step 3, toggle it to *Off*. Your fax will now respond normally.

Call request

You can send or receive a fax message *and* have a regular phone conversation *on the same call* (although, not at the same time). This is called a *call request*. It doesn't matter whether you're sending the fax or receiving it. You may fax first and then talk, or talk first and then fax.

Important: For this feature to work, the remote fax machine must have a similar call-request capability. Your machine must also have an optional handset attached.

Faxing/receiving first, then talking

To send or receive a fax first and then talk:

- 1 While your fax machine is sending or receiving the fax, press **MONITOR/CALL**.
- 2 At the remote fax machine, the ringer will sound after that machine receives each page.
- 3 If someone answers at the remote fax machine, your fax machine will ring several times. If so, pick up the optional handset. In a few seconds, the line will open and you can begin your conversation.

Talking first, then *sending* a fax

To talk first and then send a fax:

- 1 When you've finished your phone conversation, *don't hang up*.
- 2 Insert the document you want to fax.
- 3 Adjust the resolution and contrast if necessary.
- 4 Tell the person at the other fax machine to press **START** and to hang up his/her handset. *Don't hang up your handset yet!*
- 5 When you hear fax tones, press **START** and hang up your fax machine's optional handset. Your fax machine will send the document.

Talking first, then *receiving* a fax

To talk first and then receive a fax:

- 1 When you've finished your phone conversation, *don't hang up*.
- 2 Tell the person at the other fax machine to press **START** and to hang up his/her handset. *Don't hang up your handset yet!*
- 3 When you hear fax tones, press **START** and hang up your machine's optional handset. Your machine will receive the document and print it out.

Responding to a call request

If someone requests a call *from* you during a fax communication, you'll hear a long ring after the receiving machine has received each page. To answer the call request:

- 1 Lift your machine's optional handset, and listen for a few seconds. You may hear a brief series of fax tones.
- 2 Shortly, the line will open and the person at the other end of the line will answer. You and the other person now can have a normal phone conversation.

The power of QuadAccess^{fi}

Your fax machine's *QuadAccess* feature sharply reduces the time you might spend waiting for the machine to finish its work. QuadAccess is a more powerful version of what already is a pretty powerful feature, called *dual access*. While a fax with normal dual access allows you to do two things at once, QuadAccess allows you to do *four* operations at once. *For example*, even if the machine is (1) printing a copy, (2) transmitting from memory and (3) scanning documents for a different memory transmission, you can still (4) program the machine.

Note: If your machine is MFX-1200:
The MFX-1200 cannot printing and scanning at same time.
If you try to scanning the document during the machine is printing, the following message will be shown:

OK: Will Scan Soon

If the machine is printing the lists, the machine will scan the document after the printing is finished.

If the machine is printing the stored document or received document, the machine will pause the current printing job and it will give priority to scanning the document. After scanning is finished, the machine resumes the printing job.

F-Code Boxes

F-Code: an introduction

The ITU-T, the United Nations agency that standardizes international telecommunications, has created a fax industry standard for using sub-addressing and password-based communication. One name for this standard is F-Code, and that's what we'll call it in these instructions and on your machine's display.

How sub-addressing works

To help understand sub-addressing, think about how someone in a large company receives mail. For example, mail for the Accounting department is first delivered to the company's main mailroom. Then the mailroom routes the mail to Accounting.

That's the idea behind sub-addressing. Your fax and another F-Code-compatible fax exchange special signals to indicate just where the fax really should go. It's as if the sending fax is saying, "Deliver this to room 48," and the receiving fax does just that.

Your machine has up to 50 mailboxes for these special deliveries. When someone sends an F-Code fax to you, your machine receives it into one of those 50 mailboxes whichever box the sender chooses.

Sending F-Code securely

For greater security, you can set up a password with each F-Code sub-address, which lets you use secure transmission, polling and relay broadcasting when communicating with any other F-Code compatible fax machine.

Guidelines for using F-Code

- (1) To use ITU-T sub-addressing, you must create F-Code boxes in your machine
- (2) Your machine holds up to 50 of these boxes
- (3) Your machine stores up to 30 documents into each F-Code box (each document can include one or more pages)

Creating or modifying an F-Code box

Choosing the F-Code box type

Before you set up an F-Code box, first decide how your callers will use it—as a bulletin box, a security box or a relay box.

Bulletin box Stores documents that people in remote locations retrieve by *polling* the box. For example, your sales branches could call in at any time to get a printout of your latest prices that you've stored in a bulletin box.

A bulletin box stores both scanned and retrieved documents, and it holds its contents indefinitely (as long as the unit has AC power).

Security box Receives and stores F-Code secure communications.

Relay box Receives documents, then relays them to other machines. The machine that relays the document is called a *hub*. Your fax machine can either *send* to a hub or it can *be* a hub.

4 elements of an F-Code box

Each F-Code box has the following four elements:

- (1) F-Code box number (01-50)
- (2) F-Code box name (up to 16 characters)
- (3) F-Code sub-address (up to 20 characters - can include numbers and the * and # characters only)
- (4) I.D. Code (4 digits)

You will choose the information for each of these elements, and enter it into your machine. The following steps will walk you through entering and changing that information.

To create or modify an F-Code box:

- 1** Keep pen and paper with you as you follow these steps. As you decide on a sub-address and enter it into your machine, write it down. Remember to: (1) write down which box goes with which sub-address, (2) write down any passwords or I.D. codes you enter, (3) keep these printed records in a safe place.

- 2** Press **Program key**, c, 4, 0, 1, **ENTER**. Depending on whether you already have a name entered for F-Code box 01, the LCD shows:

Select F-Code Box 01:No Number Stored	or	Select F-Code Box 01:NY Branch Office
--	----	--

- 3** Use the numeric keypad to enter the two-digit number (01-50) of the F-Code box you want to create or modify. Here, we've entered **0, 3** and see either:

Select F-Code Box 03:No Number Stored	or	Select F-Code Box 03:Muratec America
--	----	---

- 4** If want to select a different F-Code box than the one that appears on the LCD, use the numeric keypad to enter the two-digit F-Code box number now.

- 5** Press **ENTER**. What you do next depends on whether you're creating or modifying the F-Code box:
If creating skip to step 7.
If modifying the LCD asks you to enter the proper I.D. code. The LCD shows:

03:Set F-Code Box Enter I.D. Code: ***

- 6** Use the numeric keypad to enter the 4-digit I.D. code (not the ITU-T sub-address and not the ITU-T password) and then press **ENTER**.

Note: If you enter an invalid I.D. code, the fax machine rejects the attempt and aborts this operation.

- 7** The machine is now asking you to name this F-Code box. The LCD shows:

03:Box Name;Upper _	or	03:Box Name;Upper Muratec America_
------------------------	----	---------------------------------------

If you do not want to enter or change this F-Code box's name, skip to step 9. If you do want to enter or change this F-Code box's name, go on to step 8.

- 8** Enter the name by using the one-touch keys. (If necessary, review *Entering characters*, page 1.12) An F-Code box's name can be up to 16 characters in length.

- 9** Press **ENTER** to save the box's name and continue. The LCD shows:

03:Sub-Address No. _	or	03:Sub-Address No. 123456_
-------------------------	----	-------------------------------

The fax machine now asks for this F-Code box's sub-address. This is the numerical identifier you must enter in order to communicate with any remote F-Code compatible fax.

If you do not want to change an existing sub-address, skip to step 11.

- 10** Use the numeric keypad to enter the sub-address to identify this F-Code box. The sub-address can be up to 20 characters in length and include any combination of numbers and the * and # characters (but no other non-numeric characters).

03:Sub-Address No. 654321_

Note: No other F-Code box in this machine can have the same sub-address as the one you enter here.

- 11** Press **ENTER** to save the sub-address.

Note: If you entered a sub-address already being used by another F-Code box, the machine beeps and briefly displays:

03:Sub-Address No. Sub-Address In Use
--

The machine now returns you to step 10. Please enter a different number for your F-Code box's sub-address.

- 12** Next, the machine asks for your F-Code box s password. This is the password for ITU-T-compatible F-Code fax transactions. The LCD shows:

03: Password _	or	03: Password 123456789*#_
-------------------	----	------------------------------

Note: You don t need to have a password for the F-Code box. However, using a password will make your F-Code communication much more secure.

If you *do not* want to enter or change this box s password, skip to step 14.

- 13** Use the numeric keypad to enter this box s ITU-T-compatible password. This password can be up to 20 characters in length and include any combination of numbers and the * and # characters (but no other non-numerical characters). Here, we ve entered 135*7#9.

03: Password 135*7#9_

Note: You cannot change the *type* of an existing F-Code box. If you re modifying an existing F-Code box and want to change the box *type*, you first must erase the old box, then create a new one.

- 14** Press ENTER to save the password. The LCD now shows:

Box Type :Bulletin ← /→ /Enter

The fax machine is asking which box type you want to assign to this box *bulletin*, *security* or *relay*.

Press ◀ or ▶ until the type of box you want appears.

- 15** Press ENTER.
If you chose *Bulletin*, go on to step 16.
If you chose *Security*, skip to step 17.
If you chose *Relay*, skip to step 20.

If you chose Bulletin:

- 16** The bulletin box has four additional settings:
Reception protection (Rx Protect on the LCD)
Automatic printing of received documents (Auto Print)
Overwriting documents (Overwrite Doc.)
Erasure of transmitted documents (Erase Tx Doc.)

Rx Protect Reception protection tells this box if it s okay to receive documents from remote locations. Callers can then poll these documents.

Rx Protect :Off ← /→ /Enter

On: *Open* this box to receive documents from callers.

Off: *Do not* open this box to receive documents from callers.

Press ◀ or ▶ until the mode you want appears.

Then press ENTER to save the setting and go on to the next one.

Auto Print Automatic printing of received documents tells the fax machine if it should print a document automatically upon receiving it into this box.

Note: This setting is available only when the reception protection (*Rx protect*) setting is set to *off* (see above).

Auto Print :Off ← /→ /Enter

On: Print the document automatically when the box receives it.

Off: Print the document manually, when you want to print it.

Press ◀ or ▶ until the mode you want appears.

Then press ENTER to save the setting and go on to the next one.

Overwrite Doc Overwriting documents tells your machine if it should overwrite (erase) existing documents when it receives a new one.

Note: This setting is available only when the reception protection setting is set to off (see *Rx Protect* above).

Overwrite Doc. :Off ← /→ /Enter

On: When your machine receives a new document into this box, it will erase any documents currently stored in it.

Off: When your machine receives a new document into this box, it *will not* erase the documents stored in it. Your machine can store up to 30 *documents* (each document can include one or more pages) in each box.

Press ◀ or ▶ until the mode you want appears.

Then press ENTER to save the setting and go on to the next one.

Erase Tx Doc Erasure of transmitted documents tells your machine if it should erase a document from the box after a caller retrieves (polls) the document.

```
Erase Tx Doc. :Off
←/→/Enter
```

On: Your machine erases the document from the box as soon as it sends it. If you choose **On**, this box can be polled only once per document.

Off: Your machine does not erase a document from the box when it's polled. As long as your machine holds AC power and you do not erase the document from the box, the document is available indefinitely for polling.

Press **◀** or **▶** until the mode you want appears.

Press **ENTER** to save the setting. Then skip to step 24.

If you chose Security:

- 17** The machine asks how long you want to keep a document stored in your machine's F-Code box. The LCD shows:

```
F-Code Doc Hold Time
Hold Time (00-31):00
```

- 18** Use the numeric keypad to enter a two-digit number indicating how many days (00-31), you want your fax machine to keep received documents in this F-Code box. Here, we've entered *09*, for nine days:

```
F-Code Doc Hold Time
Hold Time (00-31):09
```

Note: Your fax machine can store incoming documents in F-Code boxes (up to 30 documents) as long as 31 days, after which it automatically erases the documents. But if your machine has plenty of memory, you may want to override the 31-day limit in order to keep the documents indefinitely. If so, enter *00*. If you choose this, you will have to delete documents manually. (You may want to contact your authorized Muratec dealer regarding optional memory expansion.)

- 19** Press **ENTER** to save the settings. Skip to step 24.

If you chose Relay:

- 20** The machine asks for the fax number for the remote unit. The LCD shows:

```
Enter Relay Number
_
```

- 21** Enter the fax number using a one-touch key, a speed-dial number or a call group number. You cannot use the numeric keypad to enter these numbers.

To add each fax number, press **BROADCAST** between each one to insert a *comma*, then enter the number. You can specify up to 200 numbers for a remote unit.

```
Enter Relay Number
S001,G12_
```

- 22** Press **ENTER** to save the settings. The LCD shows:

```
Select TTI :Sender
←/→/Enter
```

The machine asks for the type of TTI you want to appear on the faxes that are relayed to other callers.

Sender Relay the document with sender unit's TTI (*don't* send your TTI).

Both Relay the document with both the sender unit's TTI and your TTI.

Yours Relay the document with your TTI instead of the sender unit's.

Press **◀** or **▶** until the mode you want appears.

- 23** Press **ENTER** to save the settings. The LCD shows:

```
Auto Print :Off
←/→/Enter
```

On: Print the document automatically when it's received.

Off: The machine does not print it, but only relays it to the other machine.

Press **◀** or **▶** until the mode you want appears.

Then press **ENTER** to save the settings and go on to step 24.

- 24** The machine asks for your F-Code box's four-digit security I.D. code. This is the I.D. code for the box's security, which you use to **(1)** print a document any remote F-Code-compatible fax sends to this F-Code box or **(2)** you enter before you can make any changes to this F-Code box.

```
03:Set F-Code Box
Enter I.D. Code:0000
```

If you do not want to change the I.D. code, skip to step 27.

- 25** Decide on a four-digit I.D. code (*0001-9999*) for this F-Code box. **Write it down**, and put it in a safe place.

Important: Do not use *0000* as an I.D. code.

26 Use the numeric keypad to enter the four-digit I.D. code for this F-Code box.

Important: After completing this step, you must know this code to print documents sent to this F-Code box. Be sure to write it down.

27 Press **ENTER** to save the F-Code box information.

To create or modify another F-Code box, repeat steps 3-27.

To finish, press **STOP**.

Printing a list of F-Code boxes

The list of F-Code boxes includes:

- (1) Each box's identifier number
- (2) Box name (if any)
- (3) Sub-address
- (4) Password
- (5) Box type
- (6) Each box's settings

To print a list of your F-Code boxes, press **Program key, E, 1, 1, 3, ENTER**.

Printing a list of documents stored in your F-Code boxes

The list of documents stored in your machine's F-Code boxes includes:

- (1) Each box's identifier number
- (2) Box name (if any)
- (3) Box type
- (4) Each file number (or document number) that is stored

To print a list of documents stored in F-Code boxes, press **Program key, E, 1, 1, 4, ENTER**.

Using a bulletin box

Storing a document

Your fax machine can store up to 30 *documents* in each bulletin box.

Note: For this operation to work, two things must be true:

The bulletin box must exist on your fax machine.

You must know the bulletin box's two-digit number (01-50) and four-digit I.D. code. (See *Creating or Modifying an F-Code box*, pages 3.26-3.27, if necessary.)

To store a document in a bulletin box for polling:

1 Insert the document and make any necessary adjustments.

2 Press **Program key, D, 1, 0, 2, ENTER**. The LCD shows:

Select F-Code Box 01:No Number Stored	or	Select F-Code Box 01:Murata Machinery
--	----	--

3 Use the numeric keypad to enter the two-digit identifier number (01-50) of the F-Code box where you want to store the document.

Here, we've entered **0, 3**:

Select F-Code Box 03:Muratec America

4 If you want to use a different F-Code box than the one that appears on the LCD, enter the box number now.

5 Press **ENTER**. The LCD shows:

03:F-Code Document Enter I.D. Code:***

6 Use the numeric keypad to enter the four-digit I.D. code. Here, we've entered *2345*:

03:F-Code Document Enter I.D. Code:2345
--

- 7** Press **ENTER**.
If you've entered an incorrect I.D. code, your fax machine rejects the attempt and returns to standby mode.
If you've entered the correct I.D. code, the display shows:

```
Overwrite Doc. :Off
← /→ /Enter
```

If you choose:

- On:** Your bulletin box erases the currently stored document when a new document is stored in it
Off: Your bulletin box keeps both the currently stored document and the new document, up to 30 documents in each box.

- 8** Press **◀** or **▶** until the mode you want appears.
9 Press **ENTER** to save the setting. Your machine starts scanning the document into the selected bulletin box:

```
F-Code Doc. File: 1
A4 Mem 99%
```

Important: The file number (shown above as *1*) tells you how many documents are in this bulletin box. Your machine numbers files *1-30*. You need to know the file's number to erase or print it.

Printing a document stored in a bulletin box

You can print a document stored in your machine's F-Code bulletin boxes without erasing the document from memory.

To print a stored document:

- 1** Press **Program key, D, 3, 0, 2, ENTER**. The LCD shows:

```
Select F-Code Box
01:Murata Machinery
```

- 2** Use the numeric keypad to enter the two-digit number (*01-50*) of the F-Code bulletin box that stores the document you want to print. We've entered *03*:

```
Select F-Code Box
03:Muratec America
```

- 3** Press **ENTER**. The LCD shows:

```
03:F-Code Document
Enter I.D. Code:***
```

- 4** Use the numeric keypad to enter your F-Code box's four-digit I.D. code. Here we've entered *2345*:

```
03:F-Code Document
Enter I.D. Code:2345
```

- 5** Press **ENTER**.
If you've entered an incorrect I.D. code, your fax machine rejects the attempt and aborts this operation.
If you've entered the correct I.D. code, the display shows:

```
03:F-Code Document
File No. :_
```

- 6** Use the numeric keypad to enter the file number (*1-30*) of the document you want to print. Here we've entered *3*.

```
03:F-Code Document
File No. :3_
```

Note: If you want to print *all* documents stored in the bulletin box, simply enter *0* (zero).

- 7** Press **ENTER**.
Your fax machine prints the chosen document(s), then returns to standby mode.

Note: If the F-Code box is not storing any documents, the machine briefly displays the following before returning to standby mode:

```
03:Select F-Code Box
No Document Stored
```

Erasing a document stored in a bulletin box

To erase a stored document:

- 1** Press **Program key, D, 2, 0, 2, ENTER** The LCD shows:

```
Select F-Code Box
01:Murata Machinery
```

- 2** Use the numeric keypad to enter the two-digit number (01-50) of the F-Code bulletin box that stores the document you want to erase. We've entered 03:

```
Select F-Code Box
03:Muratec America
```

- 3** Press **ENTER**. The LCD shows:

```
03:F-Code Document
Enter I.D. Code:***
```

Note: If the F-Code box is not storing any documents, the machine briefly displays the following before returning to step 2:

```
Select F-Code Box
No Document Stored
```

- 4** Use the numeric keypad to enter your F-Code box's four-digit I.D. code. Here we've entered 2345:

```
03:F-Code Document
Enter I.D. Code:2345
```

- 5** Press **ENTER**.
If you've entered an incorrect I.D. code, your fax machine rejects the attempt and aborts this operation.
If you've entered the correct I.D. code, the display shows:

```
03:F-Code Document
FileNb.      :_
```

- 6** Use the numeric keypad to enter the file number (1-30) of the document you want to erase. Here we've entered 3.

```
03:F-Code Document
FileNb.      :3_
```

Note: If you want to erase *all* documents stored in the bulletin box, enter 0 (zero).

- 7** Press **ENTER**. The LCD shows:

```
03:F-Code Document
Check      Enter/Stop
```

Note: If you want to quit without erasing *any* document in the bulletin box, press **STOP**. The machine will return to standby mode.

Note: If the F-Code box is not storing any documents, the machine briefly displays the following and then returns to standby mode:

```
03:F-Code Document
No Document Stored
```

- 8** Press **ENTER** to erase the document(s) and to return to standby mode.

```
F-Code Document
** Complete **
```

Using a security box

Printing a document you receive

When your fax machine receives a document via ITU-T sub-addressing to an F-Code security box, your machine prints a message to let you know. The message lists: **(1)** the F-Code box number that received the document, **(2)** the Box name, **(3)** the remote machine's TTI (if any), and **(4)** the file numbers stored in the F-Code box.

You then have a certain number of days (see step 17 and 18 on page 3.29) in which to print out the document before your machine automatically erases it.

Note: For this operation to work, two things must be true:

You must know the F-Code security box's two-digit number.

You must know the F-Code security box's four-digit I.D. code.

To print a received message:

- 1** Press **Program key, D, 3, 0, 2, ENTER** The LCD shows:

```
Select F-Code Box
01:Murata Machinery
```

- 2** Use the numeric keypad to enter the two-digit number (01-50) of the F-Code bulletin box that stores the document you want to print. We've entered 03:

```
Select F-Code Box
03:Muratec America
```

3 Press **ENTER**. The LCD shows:

```
03:F-Code Document
Enter I.D. Code: _***
```

Note: If the F-Code security box is not storing any documents, the machine briefly displays the following before returning to step 2:

```
03:Select F-Code Box
No Document Stored
```

4 Use the numeric keypad to enter your F-Code box's four-digit I.D. code. Here we've entered *2345*:

```
03:F-Code Document
Enter I.D. Code: 2345
```

5 Press **ENTER**.

If you've entered the correct I.D. code, your fax machine prints all documents in the F-Code security box and then erases them.

If you've entered an incorrect I.D. code, your fax machine aborts the operation and returns to standby mode.

Using a relay box

Once your fax machine receives a document via ITU-T sub-addressing to one of its F-Code relay boxes, it sends it to the other fax machines that you've set up on your relay box. (See *Creating or Modifying an F-Code box*, pages 3.26-3.27.)

If you set the Auto print mode to *on* when you created the relay box, your machine will *print* the received document, then relay it to the other machine. Otherwise, your machine will *only relay* it to the other machines, not print it. See *If you chose Relay*, page 3.29 for more details on this setting.

Also, you can send (*relay broadcast initiation*) the document to another hub machine's F-Code box and get that machine to relay it to others. See *F-Code transmission* on pages 3.34-3.35 for more detail.

The hub performs a *relay broadcast*, and the machine which sends the original document to the hub has performed a *relay broadcast initiation*.

Erasing an empty F-Code box

An F-Code box must be empty in order to erase it. (If you select an F-Code box in these steps which is not empty, the machine beeps. If this happens, print all documents in that box before erasing it.)

To erase an empty F-Code box:

1 Press **Program key, C, 4, 0, 2, ENTER**. The LCD shows:

```
Select F-Code Box
01:No Number Stored
```

or

```
Select F-Code Box
01:Murata Machinery
```

2 Use the numeric keypad to enter the two-digit identifier number (*01-50*) of the F-Code box you want to erase. Here, we've entered **0, 3** and see:

```
Select F-Code Box
03:Muratec America
```

3 If you want to erase a different F-Code box than the one that appears on the LCD, enter the box number now.

4 Press **ENTER**. If the F-Code box is empty, the LCD shows:

```
03:Erase F-Code Box
Enter I.D. Code: _***
```

Important: If you select an F-Code box which is *not* empty, the machine beeps and, before returning to step 3, briefly displays:

```
Select F-Code Box
Box In Use
```

Print any documents received in the F-Code box, then repeat this procedure from the beginning to erase the box. Otherwise, select another F-Code box.

5 Use the numeric keypad to enter the four-digit I.D. code. Here, we've entered *2345*:

```
03:Erase F-Code Box
Enter I.D. Code: 2345
```

- 6** Press **ENTER**.
If you've entered an incorrect I.D. code, your fax machine rejects the attempt and returns to standby mode.
If you've entered the correct I.D. code, the display shows:

```
03:Erase F-Code Box
Check Enter/Cancel
```

Note: If you want to quit without erasing the F-Code box you've selected, press **CANCEL**. The fax will return to step 2.

Note: If you want to quit without erasing *any* F-Code box, press **STOP**. The machine returns to standby mode.

- 7** Press **ENTER** to erase the F-Code box.

```
Erase F-Code Box
** Complete **
```

To erase another F-Code box, repeat steps 2-7.
To finish, press **STOP**.

F-Code transmission and polling

With F-Code, your machine can send secure transmissions, perform relay broadcast initiations and even poll from other ITU-T-equipped machines, regardless of manufacturer.

You can do this two ways:

Using the programmable one-touch key (see pages 3.41-3.44)

Entering the ITU-T sub-address and password directly, which is what we'll describe here.

Note: For F-Code communication to work, three things must be true:

The remote fax machine must support ITU-T sub-addressing

The remote fax must have a mailbox with an ITU-T sub-address created on it

You must know the ITU-T sub-address and password (if any) for the remote machine's mailbox

F-Code transmission

- 1** Insert the document.
- 2** Adjust the resolution and contrast if necessary.

- 3** If you want to toggle between real time transmission and memory transmission, press **MEMORY TRANSMIT**.

- 4** Press **ADVANCED FUNCTIONS** *three* times and then press **ENTER**.

```
Enter Sub-Address
_
```

- 5** Use the numeric keypad to enter the appropriate sub-address in the remote machine. In this example, we've entered *123456*.

```
Enter Sub-Address
123456_
```

Note: If you make a mistake, press **CANCEL** to erase the character, then enter the correct number.

- 6** Press **ENTER**. The LCD shows:

```
Enter Password
_
```

Note: If this sub-address does not have a password, skip to step 8.

- 7** Use the numeric keypad to enter the password. In this example, we've entered *654321*.

```
Enter Password
654321_
```

- 8** Press **ENTER**. The LCD shows:

```
Enter Fax Number
_
```

- 9** Enter the fax number either by pressing a one-touch key, entering a speed-dial number or dialing from the numeric keypad. Do *not* press **START**.

- 10** What you do now depends on when you want the transmission to begin.

To have it begin *now*, skip to step 13.

To delay it, go on to step 11.

- 11** Press **ADVANCED FUNCTIONS**, **ENTER**. The LCD shows:

```
Delayed
Enter Time: 15/17:05
```

- 12** Use the numeric keypad to enter the day and time when the transmission should begin, then press **ENTER**.

13 Press **START**.

If in step 10 you chose an immediate transmission, your fax machine begins dialing. If you chose a delayed command, the machine shows **Reserved** on the LCD, indicating that it has stored the command in memory and will complete it later.

F-Code polling

1 Press **FAX** to switch the machine to Fax mode.

2 Press **ADVANCED FUNCTIONS** *four* times and then press **ENTER**.

Enter Sub-Address
_

3 Use the numeric keypad to enter the appropriate sub-address. In this example, we've entered *123456*.

Enter Sub-Address
123456_

Note: If you make a mistake, press **CANCEL** to erase the character, then enter the correct number.

4 Press **ENTER**. The LCD shows:

Enter Password
_

Note: If this sub-address does not have a password, skip to step 6.

5 Use the numeric keypad to enter the password. In this example, we've entered *654321*.

Enter Password
654321_

6 Press **ENTER**. The LCD shows:

Enter Fax Number
_

7 Enter the fax number either by pressing a one-touch key, entering a speed-dial number or dialing from the numeric keypad. Do **not** press **START**.

8 What you do now depends upon when you want the polling to begin.

To have it begin *now*, skip to step 11.

To delay it, go on to step 9.

9 Press **ADVANCED FUNCTIONS**, **ENTER**. The LCD shows:

Delayed
Enter Time: 15/17:05

10 Use the numeric keypad to enter the day and time when the polling should begin, then press **ENTER**.

11 Press **START**.

If in step 8 you chose an immediate polling, your fax machine begins dialing. If you chose a delayed command, the machine shows **Reserved** on the LCD, indicating that it has stored the command in memory and will complete it later.

Programmable one-touch keys

Using the power of programmable one-touch keys

In order to complete some operations on your machine, you may have to follow several steps and press several different buttons. But programming your machine's *one-touch keys* (**P1** and **P2**) can reduce those many steps to a simple press of a key.

You can teach the one-touch keys to carry out any of the following operations:

Communications functions:

- Delayed transmission (explained on page 3.11)
- Broadcasting (page 3.10)
- Regular polling (pages 3.15 3.16)
- F-Code transmission (page 3.34)
- F-Code polling (page 3.35)
- Batch transmission (pages 3.12 3.14)

To teach these keys, you tell the machine four simple things:

- How** The key you're programming
- Who** The number(s) the machine should dial
- What** The operation it should perform
- When** The date(s) and time(s) when you want it to perform the operation

Printouts:

- Machine settings list (page 4.10)
- Fax settings list (page 4.10)
- Copy settings list (page 4.10)
- Activity journal (page 3.22)
- Delayed commands list (page 2.9)
- One-touch list (page 3.3)
- Speed-dial list (page 3.6)
- Programmable one-touch list (page 3.49)
- Call group directory (page 3.8)
- Blocked numbers list (page 3.55)
- Sample cover page (page 3.24)
- Department time list (page 3.57)
- List of F-Code boxes (page 3.30)
- List of documents stored in F-Code boxes (page 3.30)
- Batch box list (page 3.13)

- List of stored batch documents (page 3.13)
- Macros list (page 3.20)

Document storage:

- Regular polling documents (page 3.15)
- F-Code polling documents (pages 3.30 3.31)

Programming a delayed transmission

To program a delayed transmission into a programmable one-touch key:

- 1** Press **Program key, A, 3, 0, 1, ENTER**. The LCD shows the first empty programmable one-touch number available:

```
Select Program No.
P2:No Number Stored
```

- Note:** If **P2** appears on the LCD, it means that you have already entered a number for **P1**. You can see what you programmed into **P1** by pressing **◀**, if you want. For example, if you set **P1** for storing of the polling document, you will see:

```
Select Program No.
P1:Polling Document
```

Press **▶** to go back to the programmable one-touch key you want to enter.

- Note:** To erase a programmable one-touch key, see page 3.49.

- 2** Press the key that you want to program or change. Here, we've selected **P2**.

```
Select Program No.
P2:No Number Stored
```

- Note:** If you're changing a previously stored command: If your previous command for this key was a for a delayed operation, and you want to keep this key programmed for a delayed operation, use these instructions to make changes. But if you want to assign this key to a completely different operation for batch transmission, then you must first erase the stored command before programming the new one.

- 3** If you want to select a different programmable one-touch key than what appears on the LCD, press that key now.

- 4** Press **ENTER**. The LCD asks which operation you want to program into the programmable one-touch:

```
Type :Communication
← /→ /Enter
```

Note: If changing a previously stored command, skip to step 7.

- 5** Press **▶** until *Communication* appears.

```
Type :Communication
← /→ /Enter
```

- 6** Press **ENTER**. The LCD now shows either:

```
P2:Fax#/Advan.Func.
_ or P2:Fax#/Advan.Func.
9-5558743_
```

- 7** Use the numeric keypad to enter the number *exactly* as your machine should dial it, including whatever codes your phone system requires. The number can be up to 40 characters in length:

```
P2:Fax#/Advan.Func.
9-5550629_
```

Your display can show only 20 characters at a time. To view characters beyond those 20, press **◀** to scroll to the left or **▶** to scroll to the right.

Important: Do **not** press **ENTER**.

- 8** Now, while you can still see the fax number on the LCD, press **ADVANCED FUNCTIONS, ENTER**. The LCD shows:

```
Delayed
Enter Time: 11/20:30
```

- 9** Next, tell your fax to carry out this delayed command one of these ways:

Option 1: Perform the command *once* at a certain time on a certain day of the month. (For example, Do this at 5:05 PM on the 30th.) To select this option, use the numeric keypad to enter the date and time when the fax should perform the command:

```
Delayed
Enter Time: 30/17:05
```

Option 2: Perform the command at a certain time *each day you press the key*. (For example, Do this at 5:05 PM today.) To select this option, use the numeric keypad to enter **0, 0** and then the time the fax should perform the command:

```
Delayed
Enter Time: 00/17:05
```

- 10** Press **ENTER, ENTER**. The LCD asks if you want to make additional settings for this programmable one-touch number.

```
Option :Off
← /→ /Enter
```

If you *do not* want to make additional settings, press **ENTER**. Then skip to step 24.

If you *do* want to make additional settings, press **▶** and **ENTER**.

- 11** The LCD asks which resolution you want to use for this programmable one-touch number.

```
Resolution :----
← /→ /Enter
```

- 12** Press **▶** until the mode you want appears.

Note: For any of the following settings, choose *----* if you do not want to specify the displayed setting for this programmable one-touch key.

- 13** Press **ENTER**. The LCD asks you to select a contrast mode for each programmable one-touch number.

```
Contrast :----
← /→ /Enter
```

- 14** Press **▶** until the mode you want appears.

- 15** Press **ENTER**. The LCD asks if you want the memory transmission on or off when using this programmable one-touch number.

```
Memory Tx :---
← /→ /Enter
```

- 16** Press **▶** until the mode you want appears.

- 17** Press **ENTER**. The LCD asks you for the type of confirmation report you want to set for this programmable one-touch number.

```
Report      :—
← /→ /Enter
```

- 18** Press **▶** until the mode you want appears.

- 19** Press **ENTER**. The LCD asks if you want to send a cover page for this programmable one-touch number.

```
Cover Page  :—
← /→ /Enter
```

- 20** Press **▶** until the mode you want appears.

- 21** Press **ENTER**. The LCD asks if you want to turn the Fax & Copy feature on or off for this programmable one-touch number.

```
Fax & Copy  :—
← /→ /Enter
```

Note: When the memory transmission is set to off in step 15, this LCD will not appear and go to step 24.

- 22** Press **▶** until the mode you want appears.

- 23** Press **ENTER**.

- 24** Press **STOP** to return your machine to standby mode.

Programming a broadcast / group

Programming a broadcast is very similar to programming a delayed transmission. But instead of sending to just one phone number, you set up multiple numbers for the transmission.

To program a broadcast / group into a programmable one-touch key:

- 1** Press **Program key, A, 3, 0, 1, ENTER**. The LCD shows the first empty programmable one-touch number available:

```
Select Program No.
P2:No Number Stored
```

Note: If **P2** appears on the LCD, it means that you have already entered a number for **P1**. You can see what you programmed into **P1** by pressing **◀**, if you want. For example, if you set **P1** for storing of the polling document, you will see:

```
Select Program No.
P1:Polling Document
```

Press **▶** to go back to the programmable one-touch key you want to enter.

Note: To *erase* a programmable one-touch key, see page 3.49.

- 2** Press the key that you want to program or change. Here, we've selected **P2**.

```
Select Program No.
P2:No Number Stored
```

Note: If you're changing a previously stored command: If your previous command for this key was a for a broadcast/group transmission, and you want to keep this key programmed for a broadcast/group transmission, use these instructions to make changes. But if you want to assign this key to a completely different operation for batch transmission, then you must first erase the stored command before programming the new one.

- 3** If you want to select a different programmable one-touch key than what appears on the LCD, press that key now.

- 4** Press **ENTER**. The LCD asks which operation you want to program into the programmable one-touch:

```
Type :Communication
← /→ /Enter
```

Note: If changing a previously stored command, skip to step 7.

- 5 Press ► until *Communication* appears.

```
Type :Communication
← /→ /Enter
```

- 6 Press ENTER. The LCD now shows either:

```
P2 : Fax# / Advan . Func .
_                               or   P2 : Fax# / Advan . Func .
_                               9-5558743_
```

- 7 Use the numeric keypad to enter up to 230 fax numbers you can use any combination of call groups, one-touch keys, speed-dial numbers and manually-dialed numbers.

Important: Do not press ENTER.

Press BROADCAST to enter a comma between each number or call group.

Important: Do not insert a comma after the **last** number.

To enter a *speed-dial number*, press SPEED DIAL/TEL INDEX and the number s three-digit identifier.

To enter a *call group*, press GROUP DIAL and the group s identifier number.

```
P2 : Fax# / Advan . Func .
G5 , G7 , [ 01 ] , S006 , 9-55
```

Your display can show only 20 characters at a time. To view characters beyond those 20, press ◀ to scroll to the left or ▶ to scroll to the right.

- 8 If you want the broadcast to begin *immediately* every time you press the key, press ENTER and skip to step 11.
If you want to *delay* the broadcast, press ADVANCED FUNCTIONS, ENTER.

- 9 Next, tell your fax to carry out this delayed command one of these ways:

Option 1: Perform the command *once* at a certain time on a certain day of the month. (For example, Do this at 5:05 PM on the 30th.)
To select this option, use the numeric keypad to enter the date and time when the fax should perform the command:

```
Delayed
Enter Time: 30/17:05
```

Option 2: Perform the command at a certain time *each day you press the key*. (For example, Do this at 5:05 PM today.)
To select this option, use the numeric keypad to enter **0, 0** and then the time the fax should perform the command:

```
Delayed
Enter Time: 00/17:05
```

- 10 Press ENTER, ENTER.

- 11 The LCD asks if you want to make additional settings for this programmable one-touch number.

```
Option :Off
← /→ /Enter
```

If you *do not* want to make additional settings, press ENTER. Then skip to step 23.

If you *do* want to make additional settings, press ► and ENTER.

- 12 The LCD asks which resolution you want to use for this programmable one-touch number.

```
Resolution :—
← /→ /Enter
```

- 13 Press ► until the mode you want appears.

Note: For any of the following settings, choose ----- if you do not want to specify the displayed setting for this programmable one-touch key.

- 14 Press ENTER. The LCD asks you to select a contrast mode for each programmable one-touch number.

```
Contrast :—
← /→ /Enter
```

- 15 Press ► until the mode you want appears.

- 16 Press ENTER. The LCD asks you for the type of confirmation report you want to set for this programmable one-touch number.

```
Report :—
← /→ /Enter
```

- 17 Press ► until the mode you want appears.

- 18** Press **ENTER**. The LCD asks if you want to send a cover page for this programmable one-touch number.

```
Cover Page      :—
← / → / Enter
```

- 19** Press **▶** until the mode you want appears.

- 20** Press **ENTER**. The LCD asks if you want to turn the Fax & Copy feature on or off for this programmable one-touch number.

```
Fax & Copy      :—
← / → / Enter
```

- 21** Press **▶** until the mode you want appears.

- 22** Press **ENTER**.

- 23** Press **STOP** to return your machine to standby mode.

Programming regular polling

To program a regular polling operation into a programmable one-touch key:

- 1** Press **Program key, A, 3, 0, 1, ENTER**. The LCD shows the first empty programmable one-touch number available:

```
Select Program No.
P2:No Number Stored
```

Note: If **P2** appears on the LCD, it means that you have already entered a number for **P1**. You can see what you programmed into **P1** by pressing **◀**, if you want. For example, if you set **P1** for storing of the polling document, you will see:

```
Select Program No.
P1:Polling Document
```

Press **▶** to go back to the programmable one-touch key you want to enter.

- 2** Press the key that you want to program or change. Here, we've selected **P2**.

```
Select Program No.
P2:No Number Stored
```

Note: If your previous command for this key was for a polling transmission and you want to keep this key programmed for a polling transmission, use these instructions to make changes. But if you want to assign this key to a completely different operation (for a delayed transmission, for example), then you first must erase the stored command before programming the new one.

Note: To *erase* a programmable one-touch key, see page 3.49.

- 3** If you want to select a different programmable one-touch key than the one that appears on the LCD, press that key now.

- 4** Press **ENTER**. The LCD asks which operation you want to program into the programmable one-touch:

```
Type :Communication
← / → / Enter
```

Note: If changing a previously stored command, skip to step 7.

- 5** Press **▶** until *Communication* appears.

```
Type :Communication
← / → / Enter
```

6 Press **ENTER**. The LCD now shows either:

```
P2:Fax#/Advan.Func.
_
```

or

```
P2:Fax#/Advan.Func.
9-5558743_
```

7 Use the numeric keypad to enter the number *exactly* as your machine should dial it, including whatever codes your phone system requires. The number can be up to 40 characters in length:

```
P2:Fax#/Advan.Func.
9-5550696_
```

Your display shows only 20 characters at a time. To view characters beyond those 20, press **◀** to scroll to the left or **▶** to scroll to the right.

Important: Do **not** press **ENTER**.

8 Next, *while you can still see the fax number on the LCD*, press **ADVANCED FUNCTIONS** *twice* and then press **ENTER**.

9 If you want the polling to begin *immediately* every time you press the key, press **ENTER** and skip to step 12. If you want to *delay* the polling, press **ADVANCED FUNCTIONS, ENTER**.

10 Next, tell your fax to carry out this delayed command one of these ways:

Option 1: Perform the command *once* at a certain time on a certain day of the month. (For example, Do this at 5:05 PM on the 30th.) To select this option, use the numeric keypad to enter the date and time when the fax should perform the command:

```
Delayed
Enter Time: 30/17:05
```

Option 2: Perform the command at a certain time *each day you press the key*. (For example, Do this at 5:05 PM today.) To select this option, use the numeric keypad to enter **0, 0** and then the time the fax should perform the command:

```
Delayed
Enter Time: 00/17:05
```

11 Press **ENTER, ENTER**.

12 Press **STOP** to return your machine to standby mode.

Programming an F-Code transmission

For this operation to work, two things must be true:

You must know how the remote fax is using each F-Code box to which you're transmitting—for example, as a security box or a relay box. Different fax manufacturers may use slightly different terms, but the concepts are the same.

You must know the remote fax's ITU-T sub-address and password for each box to which you want to transmit.

To program an F-Code transmission into a programmable one-touch key:

1 Press **Program key, A, 3, 0, 1, ENTER**. The LCD shows the first empty programmable one-touch number available:

```
Select Program No.
P2:No Number Stored
```

Note: If **P2** appears on the LCD, it means that you have already entered a number for **P1**. You can see what you programmed into **P1** by pressing **◀**, if you want. For example, if you set **P1** for storing of the polling document, you will see:

```
Select Program No.
P1:Polling Document
```

Press **▶** to go back to the programmable one-touch key you want to enter.

Note: To *erase* a programmable one-touch key, see page 3.49.

2 Press the key that you want to program or change. Here, we've selected **P2**.

```
Select Program No.
P2:No Number Stored
```

Note: If your previous command for this key was for an F-Code transmission and you want to keep this key programmed for an F-Code transmission, use these instructions to make changes. But if you want to assign this key to a completely different operation (for a delayed transmission, for example), then you first must erase the stored command before programming the new one.

3 If you want to select a different programmable one-touch key than the one that appears on the LCD, press that key now.

4 Press **ENTER**. The LCD asks which operation you want to program into the programmable one-touch:

```
Type :Communication
←/→/Enter
```

Note: If changing a previously stored command, skip to step 7.

5 Press **▶** until *Communication* appears.

```

Type :Communication
  ← /→ /Enter
    
```

6 Press **ENTER**. The LCD now shows either:

```

P2 : Fax# / Advan . Func .
_
    
```

or

```

P2 : Fax# / Advan . Func .
9-5558743_
    
```

7 Use the numeric keypad to enter the number *exactly* as your machine should dial it, including whatever codes your phone system requires. The number can be up to 40 characters in length:

```

P2 : Fax# / Advan . Func .
9-5550629_
    
```

Your display can show only 20 characters at a time. To view characters beyond those 20, press **◀** to scroll to the left or **▶** to scroll to the right.

Important: Do **not** press **ENTER**.

8 Now, *while you still can see the fax number on the LCD*, press **ADVANCED FUNCTIONS** *three times* and then press **ENTER**. The LCD shows:

```

Enter Sub-Address
_
    
```

9 Use the numeric keypad to enter the ITU-T sub-address for the box to which you want to send the document. Here, we've entered *123456*:

```

Enter Sub-Address
123456_
    
```

10 Press **ENTER**. The LCD shows:

```

Enter Password
_
    
```

Note: If there isn't a password for this box, press **ENTER**, then skip to step 13.

11 Use the numeric keypad to enter the appropriate ITU-T password for the box. Here, we've entered *654321*:

```

Enter Password
654321_
    
```

When finished, press **ENTER**.

12 If you want the transmission to begin *immediately* every time you press the key, press **ENTER** and skip to step 15.
If you want to *delay* the transmission, press **ADVANCED FUNCTIONS**, **ENTER**.

13 Next, tell your fax to carry out this delayed command one of these ways:

Option 1: Perform the command *once* at a certain time on a certain day of the month. (For example, Do this at 5:05 PM on the 30th.)
To select this option, use the numeric keypad to enter the date and time when the fax should perform the command:

```

Delayed
Enter Time: 30/17:05
    
```

Option 2: Perform the command at a certain time *each day you press the key*. (For example, Do this at 5:05 PM today.)
To select this option, use the numeric keypad to enter **0, 0** and then the time when the fax should perform the command:

```

Delayed
Enter Time: 00/17:05
    
```

14 Press **ENTER**, **ENTER**.

15 The LCD asks if you want to make additional settings for this programmable one-touch number.

```

Option           :Off
  ← /→ /Enter
    
```

If you *do not* want to make additional settings, press **ENTER**. Skip to step 29.
If you *do* want to make additional settings, press **▶** and **ENTER**.

16 The LCD asks which resolution you want to use for this programmable one-touch number.

```

Resolution       :-----
  ← /→ /Enter
    
```

17 Press **▶** until the mode you want appears.

Note: For any of the following settings, choose *-----* if you do not want to specify the displayed setting for this programmable one-touch key.

- 18** Press **ENTER**. The LCD asks you to select a contrast mode for each programmable one-touch number.

```
Contrast      :—
← / → / Enter
```

- 19** Press **▶** until the mode you want appears.

- 20** Press **ENTER**. The LCD asks if you want the memory transmission on or off when using this programmable one-touch number.

```
Memory Tx     :—
← / → / Enter
```

- 21** Press **▶** until the mode you want appears.

- 22** Press **ENTER**. The LCD asks you for the type of confirmation report you want to set for this programmable one-touch number.

```
Report        :—
← / → / Enter
```

- 23** Press **▶** until the mode you want appears.

- 24** Press **ENTER**. The LCD asks if you want to send a cover page for this programmable one-touch number.

```
Cover Page    :—
← / → / Enter
```

- 25** Press **▶** until the mode you want appears.

- 26** Press **ENTER**. The LCD asks if you want to turn the Fax & Copy feature on or off for this programmable one-touch number.

```
Fax & Copy    :—
← / → / Enter
```

Note: When the memory transmission is set to off in step 20, this LCD will not appear and go to step 29.

- 27** Press **▶** until the mode you want appears.

- 28** Press **ENTER**.

- 29** Press **STOP** to return your machine to standby mode.

Programming F-Code polling

For this operation to work, two things must be true:

The document which you are polling must exist in the remote fax's F-Code box (ITU-T standard sub-addressing/password box).

You must know the remote fax's ITU-T sub-address and password (if any) for each box you want to poll.

To program an F-Code polling operating into a programmable one-touch key:

- 1** Press **Program key, A, 3, 0, 1, ENTER**. The LCD shows the first empty programmable one-touch number available:

```
Select Program No.
P2:No Number Stored
```

Note: If **P2** appears on the LCD, it means that you have already entered a number for **P1**. You can see what you programmed into **P1** by pressing **◀**, if you want. For example, if you set **P1** for storing of the polling document, you will see:

```
Select Program No.
P1:Polling Document
```

Press **▶** to go back to the programmable one-touch key you want to enter.

Note: To *erase* a programmable one-touch key, see page 3.49.

- 2** Press the key that you want to program or change. Here, we've selected **P2**.

```
Select Program No.
P2:No Number Stored
```

Note: If your previous command for this key was for an F-Code polling operation and you want to keep this key programmed for an F-Code polling operation, use these instructions to make changes. But if you want to assign this key to a completely different operation (for a delayed transmission, for example), then you first must erase the stored command before programming the new one.

- 3** If you want to select a different programmable one-touch key than the one that appears on the LCD, press that key now.

- 4** Press **ENTER**. The LCD asks which operation you want to program into the programmable one-touch:

```
Type :Communication
← / → / Enter
```

Advanced features

Note: If changing a previously stored command, skip to step 7.

- 5** Press **▶** until *Communication* appears.

```
Type :Communication
← /→ /Enter
```

- 6** Press **ENTER**. The LCD now shows either:

```
P2:Fax#/Advan.Func.
_
```

 or

```
P2:Fax#/Advan.Func.
9-5558743_
```

- 7** Use the numeric keypad to enter the number *exactly* as your machine should dial it, including whatever codes your phone system requires. The number can be up to 40 characters in length:

```
P2:Fax#/Advan.Func.
9-5550629_
```

Your display can show only 20 characters at a time. To view characters beyond those 20, press **◀** to scroll to the left or **▶** to scroll to the right.

Important: Do **not** press **ENTER**.

- 8** Now, *while you still can see the fax number on the LCD*, press **ADVANCED FUNCTIONS** *four times* and then press **ENTER**. The LCD shows:

```
Enter Sub-Address
_
```

- 9** Use the numeric keypad to enter the ITU-T sub-address for the box to which you want to send the document. Here, we've entered *123456*:

```
Enter Sub-Address
123456_
```

- 10** Press **ENTER**. The LCD shows:

```
Enter Password
_
```

Note: If there isn't a password for this box, press **ENTER**, then skip to step 14.

- 11** Use the numeric keypad to enter the appropriate ITU-T password for the box. Here, we've entered *654321*:

```
Enter Password
654321_
```

When finished, press **ENTER**.

- 12** If you want the transmission to begin *immediately* every time you press the key, press **ENTER** and skip to step 15.
If you want to *delay* the transmission, press **ADVANCED FUNCTIONS**, **ENTER**.

- 13** Next, tell your fax to carry out this delayed command one of these ways:

- Option 1:** Perform the command *once* at a certain time on a certain day of the month. (For example, Do this at 5:05 PM on the 30th.)
To select this option, use the numeric keypad to enter the date and time when the fax should perform the command:

```
Delayed
Enter Time: 30/17:05
```

- Option 2:** Perform the command at a certain time *each day you press the key*. (For example, Do this at 5:05 PM today.)
To select this option, use the numeric keypad to enter **0, 0** and then the time when the fax should perform the command:

```
Delayed
Enter Time: 00/17:05
```

- 14** Press **ENTER**, **ENTER**.

- 15** Press **STOP** to return your machine to standby mode.

Programming a batch transmission

For this operation to work, two things must be true:

The batch box you're using must exist on your fax machine.

You must know the batch box's identifier number (1-5).

To program a batch transmission into a programmable one-touch key:

- 1 Press **Program key, A, 3, 0, 1, ENTER**. The LCD shows the first empty programmable one-touch number available:

```
Select Program No.
P2:No Number Stored
```

Note: If **P2** appears on the LCD, it means that you have already entered a number for **P1**. You can see what you programmed into **P1** by pressing **◀**, if you want. For example, if you set **P1** for storing of the polling document, you will see:

```
Select Program No.
P1:Polling Document
```

Press **▶** to go back to the programmable one-touch key you want to enter.

Note: To *erase* a programmable one-touch key, see page 3.49.

- 2 Press the key that you want to program or change. Here, we've selected **P2**.

```
Select Program No.
P2:No Number Stored
```

Note: If your previous command for this key was for a batch transmission and you want to keep this key programmed for a batch transmission, use these instructions to make changes. But if you want to assign this key to a completely different operation (for a delayed transmission, for example), then you first must erase the stored command before programming the new one.

- 3 If you want to select a different programmable one-touch key than the one that appears on the LCD, press that key now.
- 4 Press **ENTER**. The LCD asks which operation you want to program into the programmable one-touch:

```
Type :Communication
←/→/Enter
```

Note: If changing a previously stored command, skip to step 7.

- 5 Press **▶** until *Communication* appears.

```
Type :Communication
←/→/Enter
```

- 6 Press **ENTER, ADVANCED FUNCTIONS** five times and then press **ENTER**. The LCD shows:

```
Batch Tx
Enter Box No. :_
```

- 7 Use the numeric keypad to enter the one-digit identifier for the batch box you want to assign to this one-touch key. Here, we've entered 5:

```
Batch Tx
Enter Box No. :5
```

Note: To change an identifier already entered, press **CANCEL** to erase it. Then re-enter the correct identifier.

- 8 Press **ENTER**. The LCD asks if you want to make additional settings for this programmable one-touch number.

```
Option :Off
←/→/Enter
```

If you *do not* want to make additional settings, press **ENTER**. Skip to step 16. If you *do* want to make additional settings, press **▶** and **ENTER**.

- 9 The LCD asks which resolution you want to use for this programmable one-touch number.

```
Resolution :----
←/→/Enter
```

- 10 Press **▶** until the mode you want appears.

Note: For any of the following settings, choose *----* if you do not want to specify the displayed setting for this programmable one-touch key.

- 11 Press **ENTER**. The LCD asks you to select a contrast mode for each programmable one-touch number.

```
Contrast :----
←/→/Enter
```

- 12 Press **▶** until the mode you want appears.

- 13** Press **ENTER**. The LCD asks if you want to turn the Fax & Copy feature on or off for this programmable one-touch number.

Fax & Copy :—
←/→/Enter

- 14** Press **▶** until the mode you want appears.
- 15** Press **ENTER**.
- 16** Press **STOP** to return your machine to standby mode.

Programming printouts

To program a programmable one-touch key to print a list:

- 1** Press **Program key, A, 3, 0, 1, ENTER**. The LCD shows the first empty programmable one-touch number available:

Select Program No.
P2:No Number Stored

Note: If **P2** appears on the LCD, it means that you have already entered a number for **P1**. You can see what you programmed into **P1** by pressing **◀**, if you want. For example, if you set **P1** for printing a list of the machine settings, you will see:

Select Program No.
P1:Machine Settings

Press **▶** to go back to the programmable one-touch key you want to enter.

Note: To *erase* a programmable one-touch key, see page 3.49.

- 2** Press the key that you want to program or change. Here, we've selected **P2**.

Select Program No.
P2:No Number Stored

Note: If your previous command for this key was for printing a list and you want to keep this key programmed for printing a list, use these instructions to make changes. But if you want to assign this key to a completely different operation (for a delayed transmission, for example), then you first must erase the stored command before programming the new one.

- 3** If you want to select a different programmable one-touch key than the one that appears on the LCD, press that key now.

- 4** Press **ENTER**. The LCD asks which operation you want to program into the programmable one-touch:

Type :Communication
←/→/Enter

Note: If changing a previously stored command, skip to step 7.

- 5** Press **▶** until *List Print* appears.

Type :List Print
←/→/Enter

- 6** Press **ENTER**. The LCD asks which list you want to program into the programmable one-touch:

```
P2:Machine Settings
←/→/Enter
```

- 7** Press **▶** until the list you want appears.
- 8** Press **ENTER**.
- 9** Press **STOP** to return your machine to standby mode.

Programming a document storage operation

If you want to program a programmable one-touch key to store an F-Code polling document, two things must be true:

The F-Code bulletin box must exist on your fax machine.

You must know the F-Code bulletin box's two-digit number (01-50) and name.

To program your programmable one-touch to store a regular polling document or F-Code polling document:

- 1** Press **Program key, A, 3, 0, 1, ENTER**. The LCD shows the first empty programmable one-touch number available:

```
Select Program No.
P2:No Number Stored
```

Note: If **P2** appears on the LCD, it means that you have already entered a number for **P1**. You can see what you programmed into **P1** by pressing **◀**, if you want. For example, if you set **P1** for storing of the polling document, you will see:

```
Select Program No.
P1:Polling Document
```

Press **▶** to go back to the programmable one-touch key you want to enter.

Note: To *erase* a programmable one-touch key, see page 3.49.

- 2** Press the key that you want to program or change. Here, we've selected **P2**.

```
Select Program No.
P2:No Number Stored
```

Note: If your previous command for this key was to store a document and you want to keep this key programmed to store a document, use these instructions to make changes. But if you want to assign this key to a completely different operation (for a delayed transmission, for example), then you first must erase the stored command before programming the new one.

- 3** If you want to select a different programmable one-touch key than the one that appears on the LCD, press that key now.

- 4** Press **ENTER**. The LCD asks which operation you want to program into the programmable one-touch:

```
Type :Communication
←/→/Enter
```

Note: If changing a previously stored command, skip to step 7.

- 5** Press ► until *Store Document* appears.

```

Type :Store Document
  ← /→ /Enter
    
```

- 6** Press **ENTER**. The LCD asks which storing menu you want to program into the programmable one-touch:

```

P2:Polling Document
  ← /→ /Enter
    
```

- 7** Press ► until the mode you want appears.

- 8** Press **ENTER**.
 If you select the *Polling Document* operation, skip to step 14.
 If you select the *F-Code Document* operation, go on to step 9.

- 9** The LCD asks which F-Code bulletin box you want to use.

```

Select F-Code Box
01:Murata Machinery
    
```

- 10** Use the numeric keypad to enter the two-digit identifier number (01-50) of the F-Code box in which you want to store the document. Here, we've entered **0, 3**:

```

Select F-Code Box
03:Muratec America
    
```

- 11** To select a different F-Code box than the one that appears on the LCD, enter that box number now.

- 12** Press **ENTER**. The LCD asks if you want the box to overwrite (erase) any documents it is currently storing whenever it stores a new document.

```

Overwrite Doc. :Off
  ← /→ /Enter
    
```

- On:** When your machine stores a new document into this box, it will overwrite documents stored in it.
- Off:** When your machine stores a new document into this box, it won't erase (overwrite) any documents stored in it. Your machine can store up to 30 documents in each box (each document can include one or more pages).

- 13** Press ► until the mode you want appears.
 Then press **ENTER** to save the setting.

- 14** The LCD asks if you want to program additional settings for this one-touch.

```

Option          :Off
  ← /→ /Enter
    
```

If you *do not* want to program additional settings, press **ENTER**. Go to step 22.
 If you *do* want to program additional settings, press ► and **ENTER**, then go on to step 15.

- 15** The LCD asks which resolution you want each time you use this programmable one-touch number.

```

Resolution      :———
  ← /→ /Enter
    
```

- 16** Press ► until the mode you want appears.

Note: For any of the following settings, choosing --- tells the machine to use its *default* setting for this programmable one-touch key.

- 17** Press **ENTER**. The LCD asks which contrast mode you want each time you use this programmable one-touch number.

```

Contrast        :———
  ← /→ /Enter
    
```

- 18** Press ► until the mode you want appears.

- 19** Press **ENTER**. The LCD asks if you want the Fax & Copy feature on or off each time you use this programmable one-touch number.

```

Fax & Copy      :——
  ← /→ /Enter
    
```

- 20** Press ► until the mode you want appears.

- 21** Press **ENTER**.

- 22** Press **STOP** to return your machine to standby mode.

Fax dialing with programmable one-touch

To dial a fax call using a programmable one-touch number:

- 1** Set your document in the ADF or on the FBS glass.
- 2** Make any necessary adjustments as usual.
- 3** If you are using the FBS glass, set the document size by pressing **DOCUMENT SIZE** before you press the programmable one-touch key.
- 4** Press the programmable one-touch key in which you've stored the fax communication command.

Your fax will perform the operation now, or at whatever time you programmed.

Note: To review the details of each operation, review the instructions for that operation. See page 3.36 for a list of each operation and where to find it.

If you programmed this key to delay its operation, the LCD shows:

```
** Reserved **
Jan 29 2000 17:17
```

If you programmed this key to perform the operation immediately after you press it, the LCD shows the number:

```
9-1-972-555-4335
A4 Normal
```

Printing a list of your programmable one-touch keys

Your fax machine can print a list of the commands you've stored in your programmable one-touch keys.

The list includes:

- (1)** each key's one-touch number
- (2)** the fax/telephone number
- (3)** when the command should start
- (4)** which command you've selected
- (5)** if applicable, the selected call group(s) or F-Code box(es) you've stored in the key
- (6)** the individual settings for each key

To print a list of programmable one-touch keys, press **Program key, E, 1, 0, 8, ENTER**.

Erasing a programmable one-touch key

- 1** Press **Program key, A, 3, 0, 2, ENTER**. The LCD shows the first programmable one-touch number that has been programmed:

```
Select Program No.
P1:Delayed
```

Note: If **P2** appears, it means **P1** is empty.

- 2** Press the programmable one-touch key you want to erase. Here, we've selected **P2**:

```
Select Program No.
P2:Polling
```

- 3** To erase a different programmable one-touch key than the one that appears on the LCD, press that key now.

- 4** Press **ENTER**. The LCD shows:

```
P2:Erase P One-Touch
Check Enter/Cancel
```

Important: If you want to quit without erasing the programmable one-touch key you've selected, press **CANCEL**. The fax will return to step 2.

- 5** Press **ENTER** to erase the number.

```
Erase P One-Touch
** Complete **
```

To erase another programmable one-touch key, repeat steps 2-5. Or press **STOP** to return to standby mode.

Security features

Your machine has a number of security features to keep your private fax documents private, avoid unwanted outside communication and even protect against unauthorized use of your machine.

These security features include:

(1) Security reception, (2) PIN mask, (3) Block junk fax, and (4) Department codes.

The passcode

Your machine has a *passcode protection* system which must be turned on in order to use the security features listed below:

- Security reception
- PIN mask
- Department code protection

To set your machine's passcode:

- 1 Decide on the four-digit passcode (0001 9999) you want to use. Write it down, and put it in a safe place.

Important: Do *not* use 0000. This turns off passcode protection.

- 2 Press **Program key, B, 1, 0, 2, ENTER**. The LCD shows:

```
Protect Passcode
Old Passcode   :_****
```

- 3 If you are *creating* a passcode, use the numeric keypad to enter 0000. If you are *changing* an *existing* passcode, enter the existing passcode.

- 4 Press ENTER.

- 5 Enter the new four-digit passcode. Here, we've entered 6296:

```
Protect Passcode
New Passcode   :_6296
```

- 6 Press ENTER to save the passcode.

Note: Any time you want to turn off the passcode, change the passcode back to 0000 by repeating steps 2-6 and entering 0000 in step 5.

Security reception

Security reception tells your machine to keep *all* received faxes in memory (but not print them). Then you can print them out later, at your convenience. For example, you could use this if you're concerned about workers reading documents intended for your eyes only.

Important: For this feature to work, you must have activated the *passcode protection* as described on left column. You must also *know* the passcode.

Note: In the following instructions, your machine's LCD shortens the word *Transmission* to *Tx* and the word *Receive* to *Rx*.

Activating security reception

- 1 Press **Program key, B, 2, 1, 1, ENTER**. The LCD shows:

```
Security Rx
Enter Passcode :_****
```

- 2 Use the numeric keypad to enter the protection passcode. Here, we've entered 6296:

```
Security Rx
Enter Passcode :_6296
```

- 3 Press ENTER. The LCD shows:

```
Security Rx      :Off
← / → / Enter
```

- 4 Press ◀ or ▶ until the setting you want appears. Here, we've chosen On.

```
Security Rx      :On
← / → / Enter
```

- 5 Press ENTER. The LCD shows the machine's current clock setting:

```
Security Rx
Enter Time:     _15:42
```

6 If you want security reception to begin *now* (and at this same time every day), skip to step 8. Otherwise, go on to step 7.

7 Use the numeric keypad to enter the time (use a 24-hour format) when security reception should begin every day. Type over the numbers displayed. Here, we've entered 17:35:

```
Security Rx
Enter Time:  17:35
```

To change a digit, press ◀ to move to the left, or ▶ to move right. Then enter the correct digit.

8 Press ENTER to save the setting.

Helpful tip: After setting for activating the security reception, you can assign the security reception to the Soft key (see page 3.17) to turn it on and off. Turning on the security reception by pressing a Soft key is not effected the time setting you entered at step 7. It begins the security reception immediately.

To turn the security reception on by pressing a soft key:

1 Program a Soft key for security reception. (See page 3.17.)

2 Press a Soft key that is assigned for security reception.

```
Enter Passcode :_***
```

3 Enter the protection passcode and then press ENTER. The LCD briefly shows following and the LED of the Soft key will light and the security reception begins immediately.

```
** Sec. Rx Active **
```

Note: To turn the security reception off, see *Printing from security reception/Turning off security reception*, next column.

Printing from security reception / Turning off security reception

When security reception is on, an incoming fax goes directly into your machine's memory and the MEMORY RECEIVE light comes on. But the incoming fax message is not printed.

To retrieve the faxes received during this security reception (and to return your machine to normal reception until the next time):

1 Press **Program key, D, 3, 0, 4, ENTER**

If you're using the Soft key, press the Soft key instead of this operation.

In which way, the LCD shows:

```
Security Rx Doc.
Enter Passcode :_***
```

2 Use the numeric keypad to enter the passcode. Here we've entered 6296:

```
Security Rx Doc.
Enter Passcode :6296
```

3 Press ENTER.

If you've entered the correct passcode, your fax machine will print all documents in its memory and then erase them. Then it will turn security reception off until the next time you've scheduled security reception or the Soft key which programmed security reception is pressed.

If you're using the Soft key, the LED light of the Soft key will be off.

If you've entered an incorrect passcode, your fax machine will refuse to print, and security reception remains on.

Masking the PIN

To prevent unauthorized long-distance calls, some office telephone systems require you to enter a *personal identification number (PIN)* whenever you dial long distance.

Your fax's *PIN mask feature* helps you keep that PIN number private. With the PIN mask activated, you can dial a fax number plus a PIN, but the PIN will not appear in a journal, error message printout, delayed command list or a TCR. The PIN may be up to eight characters in length. It also can include the * or # symbols, and it can be entered from the numeric keypad.

There are three possible settings for the PIN mask:

Off Turns off the PIN mask feature. Any PIN you enter will appear on any display or printout which shows the number you dial.

Mode 1 Each remote fax unit has a departmental PIN access code.

Mode 2 Each fax user has a departmental PIN access code.

Note: If you select Mode 1 and you will use a one-touch or speed-dial number, you must store the remote unit's PIN access code within that number. However, if you select Mode 2, this isn't necessary. (See *Autodialing while using the PIN mask*, next column for further details.)

Note: If you select either Mode 1 or Mode 2 and will be using batch transmission (see pages 3.12-3.14), you must store the PIN access code for the remote unit within the appropriate batch box.

Activating the PIN mask

Important: For this feature to work, you must have activated the *passcode protection* as described on page 3.50. You must also *know* the passcode.

1 Press **Program key, B, 2, 1, 2, ENTER**. The LCD shows:

```
PIN Mode
Enter Passcode :_****
```

2 Use the numeric keypad to enter the four-digit passcode. Here, we've entered *6296*.

```
PIN Mode
Enter Passcode :6296
```

Note: If you enter an invalid passcode, the machine's security feature rejects the attempt and returns to standby mode.

3 Press **ENTER**.

```
PIN Mode      :Off
← / → / Enter
```

4 Press **◀** or **▶** until the mode you want appears. In this example, we've chosen Mode 1.

```
PIN Mode      :Mode1
← / → / Enter
```

5 Press **ENTER**.

Autodialing while using the PIN mask

Note: The following instructions presume you understand how to set and use your machine's autodialer. If you need to review, see pages 3.1-3.9.

If you chose Mode 1 the PIN goes in

In Mode 1, before autodialing a number for the first time, you must add the PIN to the stored one-touch key or speed-dial number. Here's how:

1 Begin by creating or changing an entry in the autodialer. See pages 3.1-3.9 if necessary. While you're setting this up, the machine asks you to enter the PIN. The LCD shows:

```
Set PIN Number
Enter Passcode :_****
```

2 Use the numeric keypad to enter the four-digit passcode. Here, we'll use our sample passcode again.

```
Set PIN Number
Enter Passcode :6296
```

3 Press **ENTER**. In our example, we're setting speed-dial number *001*:

```
001:PIN Number
_
```

4 Use the numeric keypad to enter the desired PIN, up to eight characters in length.

```
001:PIN Number
1057_
```

5 Press **ENTER** to save the PIN.

Note: If you press **ENTER** without entering the PIN, the fax machine beeps, indicates *Invalid Number* on the LCD and then returns to step 4.

Now you may autodial the number as usual.

Important: While in PIN Mode 1, *any* autodialer numbers you use must include the PIN. This also applies to autodialer numbers used with batch transmission (see page 3.12) or programmable one-touch keys (see pages 3.36 3.49).

Note: If you select either Mode 1 or Mode 2 and will be using batch transmission, you must store the PIN access code for the remote unit within the appropriate batch box.

If you chose Mode 2 as you autodial, load the code

In this mode, you *don't* have to add the PIN to the autodialer setting. Instead, you enter the PIN manually each time you autodial:

- 1 Dial the number as you normally would, using the autodialer. Here, we've pushed one-touch key A. The machine now asks for the PIN:

Enter PIN Number
_

- 2 Use the numeric keypad to enter the PIN.

Enter PIN Number
1057_

- 3 Press **START**. Your machine dials the number.

Note: If you select either Mode 1 or Mode 2 and will be using batch transmission (see page 3.12), you must store the PIN access code for the remote unit within the appropriate batch box.

Dialing from the numeric keypad while using the PIN mask

If you've specified Mode 1 use star power

- 1 Enter the phone number, then press the * (star) key and enter the PIN. *The PIN always goes last.* For example, to dial 19725550911 with a PIN of 123456, enter 19725550911*123456:

Press Start
19725550911*123456_

- 2 Press **START**. The PIN disappears from the display, and your machine dials the desired phone number.

If you've specified Mode 2 the machine guides you

- 1 Enter the phone number as usual.

Press Start
19725550911_

- 2 Press **START**. The LCD shows:

Enter PIN Number
_

- 3 Use the numeric keypad to enter the PIN.

Enter PIN Number
123456_

- 4 Press **START**. Your machine dials the number.

Performing batch transmission while using the PIN mask

Note: The following instructions presume you are familiar with how to set and use both your machine's autodialer and its batch transmission feature. If you need to review, see pages 3.1 3.9 for more on the autodialer and/or page 3.12 for more on batch transmission.

If you've specified Mode 1 or Mode 2

Important: Any autodialer number you use with batch transmission *must* include the PIN. (To review how to include this information in an autodialer number, review the Mode 1 instructions under Autodialing while using the PIN mask, page 3.52.)

Before sending a batch transmission the first time, you must store the PIN within its batch box. Here's how:

- 1 Follow the steps for creating or modifying a batch box (pages 3.12 3.13). The LCD asks for the fax number (here, we're working with batch box 1):

1: Fax Number
_

- 2 Enter an autodialer number, or use the numeric keypad to enter the fax number, to which the batch transmission should go.

Important: If you're entering a number from the numeric keypad, enter the fax number, followed by the * (star) key and then the PIN.

- 3 Press **ENTER** to save the setting.
Note: If you press **ENTER** without entering the PIN, the fax machine beeps, indicates **No PIN Number** on the LCD and then returns you to step 2.
- 4 Continue with the steps for creating or modifying a batch box (pages 3.12 3.13).

Now you can perform batch transmission to this box while the PIN mask is activated.

Setting Block Junk Fax

Your fax machine's *Block Junk Fax* feature lets you bar the gates against unauthorized incoming faxes (junk fax). But before you block junk fax, first understand *how* this feature works, to determine if it's right for you. There are four possible settings for Block Junk Fax:

Off The feature isn't activated.

Mode1 Your fax machine checks whether the last four digits of any phone number in your autodialer matches the last four digits of the remote fax's subscriber ID (the phone number part of the TTI). If it doesn't find a match, your machine disconnects the call.

Mode2 This mode rejects any call from a number whose last eight digits match any number in the *blocked numbers list* (explained later). Your machine can hold up to 50 blocked numbers.

Mode3 This rejects numbers that are *not* in the autodialer and also rejects numbers that *are* in the blocked numbers list. This lets you keep a number on your autodialer for transmission to it, while still blocking its incoming calls by putting it in the blocked numbers list.

But before you activate the Block Junk Fax feature, please consider:

Not all fax machine owners enter their phone numbers in their Subscriber IDs. With Block Junk Fax activated, your machine would reject faxes from these machines.

Access codes can cause confusion. If an autodialer entry ends with extra codes, such as long-distance codes, Block Junk Fax will block out calls from those faxes.

To set Block Junk Fax:

- 1 Press **Program key, B, 2, 1, 0, ENTER**. The LCD shows your fax's current setting:

Block Junk Fax:Off
← / → / Enter

- 2 Press **◀** or **▶** until the mode you want appears. Here, we've chosen *Mode2*.

Block Junk Fax:Mode2
← / → / Enter

- 3 Press **ENTER** to save the setting.
What you do next depends on what you selected in step 1:
If you selected *Off* or *Mode1*, press **STOP** to return to standby mode.
If you selected either *Mode2* or *Mode3*, go on to step 4.

- 4** Depending on if you have already entered at least one number into the blocked numbers list, the LCD shows one of the following:

Enter Fax Number
01: _

or

Select BlockJunk No.
01:555-2971

- 5** If you want to modify an existing entry in the blocked numbers list, press ◀ or ▶ until you see the number you want to modify.

or

If you want to enter a new number in an already-started blocked numbers list, press ◀ or ▶ until you find an empty position in the list.

Then press **ENTER** to enter or modify the blocked number.

Note: To *clear* a number from the list, see Clearing a number from the blocked numbers list, right column.

- 6** Use the numeric keypad to enter *the last eight characters* of a fax number you want to block. For example, if you want to block a fax from someone with a Subscriber ID of *972-555-3038*, you should enter **5, 5, 5, DIALING OPTIONS, 3, 0, 3, 8:**

Enter Fax Number
01:555-3038_

To change a specific digit, press ◀ to move left or ▶ to move right until the cursor is under the digit, then use the numeric keypad to enter the correct number.

- 7** Press **ENTER** to save the setting. The LCD shows the next slot in the blocked numbers list.
If you *do not* want to enter or change a number for this slot, go on to step 8.
If you *do* want to enter or change a number for this slot, repeat steps 5-7.
- 8** Press **STOP**. Your machine will return to standby mode.

Clearing a number from the blocked numbers list

To *clear* a number from the list:

- 1** Press **Program key, B, 2, 1, 0, ENTER**.
If your Block Junk Fax setting is either *Mode2* or *Mode3*, skip to step 3.

Block Junk Fax:Off
←/→/Enter

- 2** Press ◀ or ▶ until you see your preference, *Mode2* or *Mode3*.

Block Junk Fax:Mode2
←/→/Enter

- 3** Press **ENTER**. The LCD shows:

Select BlockJunk No.
01:555-2971

- 4** Press ◀ or ▶ until you see the number you want to clear.

- 5** Press **CANCEL** to clear the number.
To clear another number from the blocked numbers list, repeat steps 4-5.
Otherwise, go on to step 6.

- 6** Press **STOP** to return your machine to standby mode.

Printing a list of the blocked numbers

Forgot which number is stored in the blocked number list? Just print a list of the blocked numbers.

To print a list of the blocked numbers, press **Program key, E, 1, 1, 0, ENTER**.

Using department codes

You can keep track of how your machine is used through its *department code* feature. When the department code setting is activated, the machine reminds each user to enter the department code before sending or polling a document. The Activity Journal then keeps track of fax transactions by department.

After you turn on this setting, assign specific code numbers to your office's fax users and tell them to enter these department codes before sending faxes.

Note: Please note that using this setting may block access to the fax machine.

Entering a department code

Your machine can hold up to 100 separate department codes.

To enter a department code:

- 1 Press **Program key, c, 3, 0, 2, ENTER**. Depending upon whether you've already entered a department code, the LCD shows:

Enter Dept. Code
001: _

or

Select Department No
001:1555

Note: If department code operation is *protected* (see page 3.57), the fax beeps briefly and then returns to standby mode. You will have to turn off the protection first, then repeat this step.

- 2 If you have not entered any codes in your fax, skip to step 4. Otherwise, go on to step 3.
- 3 To enter a new code in a department code list that's already been started, press **ENTER**. The fax will skip to the next empty position in the list.
Note: If you want to *modify* an existing entry in the department code, you first *clear* a department code you want to modify and then enter a new code (see *Clearing a department code*, right column).
- 4 Use the numeric keypad to enter the four-digit department code, *0000 9999*. Here, we've entered *1555*:

Enter Dept. Code
001: 1555

To change one digit, press **◀** to move left or **▶** to move right until the cursor is under the digit, then use the numeric keypad to enter the correct number.

- 5 Press **ENTER** to save the setting.
To enter another department code, repeat steps 4-5.
To stop entering department codes, press **STOP** to return to standby mode.

Clearing a department code

- 1 Press **Program key, c, 3, 0, 2, ENTER**. The LCD shows:

Select Department No
001:1555

Note: If department code operation is *protected* (see next page), the fax beeps briefly and then returns to standby mode. You will have to turn off the protection first, then repeat this step.

- 2 Press **◀** or **▶** until you see the code you want to clear. Here, we've selected 3111.

Select Department No
005:3111

- 3 Press **CANCEL**. The LCD shows:

3111:Erase Dpt. Code
Check Enter/Cancel

Note: If you want to quit without erasing the department code you've selected, press **CANCEL**. The machine will return to step 2.

- 4 Press **ENTER**. The code you selected will be cleared.
To clear another department code, repeat steps 2-3.
If you *don't* want to clear another department code, press **STOP** to return to standby mode.

Turning the department code setting on and off

- 1 Press **Program key, c, 3, 0, 3, ENTER**. The LCD shows:

Dept. Setting :Off
← / → / Enter

Note: If department code operation is *protected* (see next page), the fax beeps briefly and then returns to standby mode. You will have to turn off the protection first, then repeat this step.

Important: To turn the department code setting on, at least one department code must be existed in your machine.

- 2 Press **◀** or **▶** until you see the setting you want.

Dept. Setting :On
← / → / Enter

- 3 Press **ENTER**.

Turning department code protection on and off

Important: This feature will work only if you've activated the *passcode protection* (see page 3.50).

- 1** Press **Program key, c, 3, 0, 1, ENTER**. The LCD shows:

```
Set Dept. Protect
Enter Passcode: _****
```

- 2** Use the numeric keypad to enter the four-digit passcode:

```
Set Dept. Protect
Enter Passcode: 6296
```

To change one digit, press ◀ to move left or ▶ to move right until the cursor is under the digit, then use the numeric keypad to enter the correct number.

- 3** Press **ENTER**.

```
Dept. Protect :Off
←/→/Enter
```

- 4** Press ◀ or ▶ until the setting you want appears.

```
Dept. Protect :On
←/→/Enter
```

- 5** Press **ENTER** to save the setting.

Sending a fax using a department code

For this operation to work, two things must be true:

- The four-digit department code must exist on your fax machine.
- You must know the department code.

- 1** Insert the document.
- 2** Adjust resolution and contrast if necessary.
- 3** Enter the fax number by either pressing a one-touch key, entering a speed-dial number or dialing from the numeric keypad.
If you enter the fax number using a one-touch key, skip to step 5.
Otherwise, go on to step 4.

- 4** Press **START**.

```
Enter Dept. Code
_
```

- 5** Use the numeric keypad to enter the appropriate four-digit department code. In this example, we've entered *3111*:

```
Enter Dept. Code
3111_
```

- 6** Press **START** again.

Printing the department time list

To print the list, press **Program key, E, 1, 1, 2, ENTER**.

Note: If department code operation is *protected* (see left column), the fax beeps briefly and then returns to standby mode. You will have to turn off the protection first, then repeat the above.

The department time list includes the following information for each department code:

Time period covered by the department time list

Each department code

Total communication time (in hours, minutes and seconds; *HH:MM:SS*) Counts the communication time up to 999:59:59 (999 hours:59 minutes:59 seconds). If the fax exceeds the maximum time, it does not count further.

Total printed pages Counts the pages up to 65535 pages. If the fax exceeds the maximum number of pages, it counts the total pages from 0 (zero).

Note: If you want to clear the total counts of each department code, see *Clearing the current department time list*, below.

Clearing the department time list

To clear the current total counts of each department code:

Press **Program key, c, 3, 0, 4, ENTER, ENTER**.

The total communication time and total printed pages for each department code are cleared. The department code will not be erased.

Changing the default settings

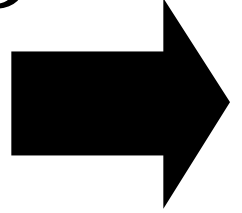

This chapter describes how to change the settings of your machine.

Settings for transmission	4.1
Settings for reception	4.3
Settings for dialing	4.5
Settings for copying	4.6
Settings for operation	4.8
Printer options	4.11

Settings for transmission

Scan settings

Default setting: Primary resolution: Normal, Primary contrast: Normal

Two different settings tell your machine how to scan documents. The initial factory settings are probably right for most applications, so try using them before changing any of these settings:

Primary resolution mode Sets the resolution for your documents. Choose either normal, fine, superfine (S Fine on the LCD) or grayscale mode (Gray).

Primary contrast mode Sets how light or dark you want faxed documents to be when they arrive at their destinations.

Note: The primary settings you choose effect your fax activity only.

To set these modes:

- 1 Press **Program key, B, 2, 0, 1, ENTER**. The LCD asks you to select a *resolution*:

```
Resolution :Normal
←/→/Enter
```

- 2 Press **◀** or **▶** until the mode you want appears. In this example, we've chosen fine resolution.

```
Resolution :Fine
←/→/Enter
```

- 3 Press **ENTER** to save the setting. The LCD asks you to select a *contrast setting*:

```
Contrast :Normal
←/→/Enter
```

- 4 Press **◀** or **▶** until the mode you want appears. In this example, we've chosen light contrast.

```
Contrast :Light
←/→/Enter
```

- 5 Press **ENTER** to save the setting.

By following the steps above, you've set your *defaults* for scanning. Before sending documents, you can *override* these default scan settings *for that transmission*.

To *override* the default resolution and contrast settings before sending a document:

Press **RESOLUTION** to change the resolution.

Press **CONTRAST** to change the contrast.

Once your document is transmitted, your machine returns to its default settings.

Setting ECM

Default setting: ON.

Line noise, or static on the line during a call, can easily disrupt the flow of data from one fax machine to another.

That's why your fax machine gives you the option of using *Error Correction Mode (ECM)*. When two fax machines communicate while running in ECM, the sending machine automatically *checks* the data as it sends. If the receiving fax machine can't verify the transmission, the first machine will re-send it as necessary.

Note: ECM gives you a better chance of transmitting a fax document over a bad phone line, but it could also slow down the transmission time. And the worse the line is, the slower the transmission. That's why the machine lets you turn ECM on or off as needed.

Note: Not all fax machines have ECM. If you've activated ECM and then transmit to a fax machine not currently using ECM, there will be no change in the fax transmission from a usual, non-ECM transmission.

- 1 Press **Program key, B, 2, 0, 9, ENTER**. The LCD shows the current ECM setting:

```
E C M Mode :On
←/→/Enter
```

- 2 Press **◀** or **▶** until the mode you want appears. In this example, we've chosen *Off*.

```
E C M Mode :Off
←/→/Enter
```

- 3 Press **ENTER** to save the setting.

Memory transmission

Default setting: *ON*.

Note: When the machine's memory is full, it can transmit only through the document feeder (real time transmission).

Note: When you use the FBS glass, the machine always uses memory transmission even if you set the memory transmission to off.

To change the default setting of memory transmission:

- 1 Press **Program key, B, 2, 0, 6, ENTER**.

```
Memory Tx      :On
  ← / → /Enter
```

- 2 Press **◀** or **▶** until the mode you want appears. In this example, we've chosen *Off*.

```
Memory Tx      :Off
  ← / → /Enter
```

- 3 Press **ENTER** to save the setting.
If the **MEMORY TRANSMIT** light glows, memory transmission is *on*.
If the **MEMORY TRANSMIT** light doesn't glow, memory transmission is *off*.

Quick Memory transmission

Default setting: *ON*.

Important: Your fax machine's memory transmission feature must be turned on to use Quick Memory transmission (see above).

To change the default setting of Quick Memory transmission:

- 1 Press **Program key, B, 2, 0, 7, ENTER**. The LCD shows:

```
Quick Tx       :On
  ← / → /Enter
```

- 2 Press **◀** or **▶** until the mode you want appears. Here, we've chosen *Off*.

```
Quick Tx       :Off
  ← / → /Enter
```

- 3 Press **ENTER** to save the setting.

TTI transmission

Default setting: *ON*.

Every fax page you send arrives at the receiving machine with a single line of text at the very top of the page. This text lists a name, called the Transmit Terminal Identifier (TTI), and a fax number. You can set the machine to not send the TTI.

- 1 Press **Program key, B, 2, 0, 8, ENTER**. The LCD shows:

```
TTI Tx         :On
  ← / → /Enter
```

- 2 Press **◀** or **▶** until the setting you want appears. In this example, we've chosen *Off*.

```
TTI Tx         :Off
  ← / → /Enter
```

- 3 Press **ENTER** to save the setting.

Settings for reception

Print settings

You can set three parameters for printing received fax messages:

- Print reduction rate
- Reduction margin
- Paper save function

You set all three in the same procedure, discussed on next page. Following is a explanation for each:

Print reduction rate

Print reduction lets you set the machine to reduce large incoming documents to a size that fits the paper in your machine. (This setting doesn't affect copies you may make with your machine.)

Below are the options for both the print reduction and copy reduction settings:

Setting	What it does
Auto	Automatically reduces printouts at variable rates down to a minimum of 50%. Tries to reduce printout to fit on one sheet of your selected paper size. If it can't, print the image at 100% size on two or more pages.
100%	Does not reduce document. (Due to the sender's TTI, this may print two pages when receiving a one-page fax document. See 97%, below.)
97%	Reduces an original so that the final printout of a one-page document (if the original isn't larger than the paper in your machine) will only be one page long, even with the TTI.
91%	Reduces documents slightly more.
81%	Reduces documents even more. Helpful for some international stationery sizes, as well as special applications.
75%	Turns <i>legal-sized</i> originals into <i>letter-sized</i> printed copies.

Reduction margin

Your machine's *reduction margin* is measured in millimeters (mm). We'll define *reduction margin* by explaining how it's used:

When a fax message enters your machine's electronic brain, the machine measures the message's length and compares it to **(a)** the length of your selected paper (not include the print margins) **plus (b)** the reduction margin you set. If the length of the incoming message is shorter than **(a)** and **(b)** put together, your machine prints the message on just one sheet.

If it's longer, your machine prints the message on more than one sheet.

Note: An *Auto* reduction setting and a reduction margin setting of 40mm will print most incoming faxes as single pages. Try this combination first and then, only if you have problems with it, select different settings.

Half-page reception

Half-page reception can conserve paper if some of the faxes you receive are half-page, memo-sized messages. When activated, this feature tells the machine to combine two of these half-page receptions onto a single sheet. Half-page reception only combines half-page messages sent back-to-back *during the same transmission*. It won't combine two half-page faxes from separate transmissions.

To adjust the print settings

Default setting: Rx reduction rate: Auto, Reduction margin: 40 mm, Half-page reception: OFF.

- 1** Press **Program key, B, 2, 0, 2, ENTER**. The LCD shows the current print reduction rate:



- 2** Press **◀** or **▶** until the reduction setting you want appears. In this example, we've chosen 91%.



Changing the default settings

- 3 Press **ENTER** to save the setting. The LCD shows the current reduction margin:

Margin
(00-85mm) : 40

- 4 Use the numeric keypad to enter the reduction margin you want. If necessary, press **◀** or **▶** to move the cursor. In this example, we've chosen 38mm.

Margin
(00-85mm) : 38

- 5 Press **ENTER** to save the setting. The LCD shows the current setting for half-page reception:

Half Page Recpt. : Off
◀/▶/Enter

- 6 Press **◀** or **▶** until the setting you want appears. In this example, we've chosen *On*.

Half Page Recpt. : On
◀/▶/Enter

- 7 Press **ENTER** to save the setting.

Setting the number of rings

Default setting: 2 time.

You can set how many times your fax machine will ring before answering a call. Choose from 1 to 9 rings.

- 1 Press **Program key, B, 2, 0, 3, ENTER**. The LCD shows:

Of Rings
(1-9) : 2

- 2 Use the numeric keypad to enter the number of rings you want, from 1 to 9. Here, we've chosen 4 rings.

Of Rings
(1-9) : 4

Note: If you enter the number except 1-9, the machine will beep briefly to warn you that it can't accept that setting.

- 3 Press **ENTER** to save the setting.

Image Rotation

Default setting: OFF.

Note: This feature is available only for the MFX-1600 model.

When this feature is activated, incoming fax messages will be rotated automatically to fit on the paper.

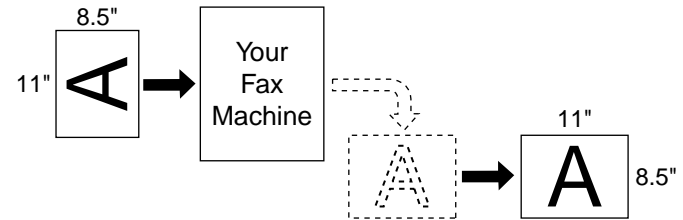

- 1 Press **Program key, B, 2, 1, 4, ENTER**. The LCD shows:

Rotate Rx : Off
◀/▶/Enter

- 2 Press **◀** or **▶** until the setting you want appears. In this example, we've chosen *On*.

Rotate Rx : On
◀/▶/Enter

- 3 Press **ENTER** to save the setting.

Settings for dialing

Changing the dialing pause length

Default setting: 2 seconds.

The pause is set by the factory to last two seconds, but you can set it to last as long as ten seconds if necessary. To change the pause length:

- 1 Press **Program key, B, 2, 0, 5, ENTER**.

```
Dialing Pause
Time      (02-10): 02
```

- 2 Use the numeric keypad to enter the length you want for the dialing pause. Here, we've chosen nine seconds.

```
Dialing Pause
Time      (02-10): 09
```

Note: The length setting requires two digits. Always enter a leading zero for lengths less than 10 seconds.

- 3 Press **ENTER** to save the setting.

Changing redial settings

Default setting: Number of redial: 2 times, Redial interval: 1 minute.

It's up to you how many times the fax redials a number and how long it waits between redials (that length of time between calls is the *redial interval*).

To program the redial settings:

- 1 Press **Program key, B, 2, 0, 4, ENTER**.

```
# Of Redials
#          (02-15): 02
```

- 2 Use the numeric keypad to enter the number of redials you want. Choose from 2 to 15 redials. In this example, we've entered 03.

```
# Of Redials
#          (02-15): 03
```

Note: Enter a leading zero when entering a quantity less than 10.

- 3 Press **ENTER** to save the setting.

- 4 The LCD now shows:

```
Redial Interval
Interval      (1-5): 1
```

- 5 Use the numeric keypad to enter the length you want between redial attempts. Choose from 1 to 5 minutes. In this example, we've chosen 4.

```
Redial Interval
Interval      (1-5): 4
```

- 6 Press **ENTER** to save the setting.

Settings for copying

Copy scan settings

Default setting: Primary document type: Text, Primary contrast: Normal

Two different settings tell your machine how to scan documents. The initial factory settings are probably right for most applications, so try using them before changing any of these settings:

Primary document type Sets the document type for your documents. Choose either Text, Text&Photo, or Photo.

Primary contrast Sets how light or dark you want copied documents to be.

Note: These primary settings you choose effect your copy activity only. To set these modes:

- 1 Press **Program key, B, 3, 0, 1, ENTER**. The LCD asks you to select a *resolution*:

```
Doc. Type:Text
  ←/→/Enter
```

- 2 Press **◀** or **▶** until the mode you want appears. In this example, we've chosen PHOTO.

```
Doc. Type:Photo
  ←/→/Enter
```

- 3 Press **ENTER** to save the setting. The LCD asks you to select a *contrast setting*:

```
Contrast :Normal
  ←/→/Enter
```

- 4 Press **◀** or **▶** until the mode you want appears. In this example, we've chosen light contrast.

```
Contrast :Light
  ←/→/Enter
```

- 5 Press **ENTER** to save the setting.

By following the steps above, you've set your *defaults* for scanning. Before copying documents, you can *override* these default scan settings *for that copying*.

To *override* the default document type and contrast settings before copying a document:

Press **DOCUMENT** to change the document type.

Press **CONTRAST** to change the contrast.

Once your document is copied, your machine returns to its default settings.

Adjusting the copy print settings

Default setting: Margin: 24 mm

Your machine's *print margin* for copying is measured in millimeters (mm). We'll define *print margin* by explaining how it's used:

When an original document is scanned, the machine measures the document's length and compares it to **(a)** the length of your selected paper (not include the print margins) **plus (b)** the print margin you set. If the length of the document is longer than **(a)** and **(b)** put together, your machine prints the document on more than one sheet.

Note: A print margin setting of 24 mm will print most documents as single pages. Try this combination first and then, only if you have problems with it, select different settings.

- 1 Press **Program key, B, 3, 0, 2, ENTER**. The LCD shows the current print margin for copying:

```
Margin
(00-85mm) : 24
```

- 2 Use the numeric keypad to enter the print margin you want. If necessary, press **◀** or **▶** to move the cursor. In this example, we've chosen 20mm.

```
Margin
(00-85mm) : 20
```

- 3 Press **ENTER** to save the setting.

Changing the copy auto reset time

Default setting: 3 minutes.

The machine returns to its initial condition automatically after a certain period of time. You can change this time from 1 to 10 minutes.

- 1 Press **Program key, B, 3, 0, 3, ENTER**.

```
Auto Reset Time
(01-10): 03
```

- 2 Use the numeric keypad to enter the time you want for the copy auto reset. Here, we've chosen ten minutes.

```
Auto Reset Time
(01-10): 10
```

Note: Enter a leading zero when entering a quantity less than 10.

- 3 Press **ENTER** to save the setting.

Setting copy auto

Default setting: Auto is set for Recording paper size

The machine automatically selects the recording paper size according to the document size and enlargement/reduction rate. You can change it to select the document size or enlargement/reduction rate automatically, instead of the recording paper size.

- 1 Press **Program key, B, 3, 0, 4, ENTER**. The LCD asks you to select the item you want to set to *Auto*:

```
Copy Auto:Paper Size
←/→/Enter
```

- 2 Press **◀** or **▶** until the item you want appears. In this example, we've chosen *Document size*.

```
Copy Auto:Doc. Size
←/→/Enter
```

- 3 Press **ENTER** to save the setting.

Setting Negative/Positive

Default setting: Off

If you frequently use the Negative/Positive (reversing black and white areas), you can set it to on for default setting by following procedure.

- 1 Press **Program key, B, 3, 0, 7, ENTER**.

```
Nega/Posi :Off
←/→/Enter
```

- 2 Press **◀** or **▶** until the setting you want appears. In this example, we've chosen *On*.

```
Nega/Posi :On
←/→/Enter
```

- 3 Press **ENTER** to save the setting. The machine returns to the standby mode with following display:

```
Copy <Nega/Posi> 1
Ltr [ Ltr ] 100%
```

Setting combine

Default setting: Off

Note: This feature is available only for the MFX-1600 model.

If you frequently use the combine feature, you can set it to on for default setting by following procedure.

- 1 Press **Program key, B, 3, 0, 8, ENTER**.

```
Combine :Off
←/→/Enter
```

- 2 Press **◀** or **▶** until the setting you want appears. In this example, we've chosen *On*.

```
Combine :On
←/→/Enter
```

- 3 Press **ENTER** to save the setting. The machine return to the standby mode with following display:

```
Copy <Combine> 1
Ltr [ Ltr ] 100%
```

Settings for operation

Setting the silent mode

Default setting: OFF.

Silent mode allows you to mute the ringer, the alarm and the key tones.

Ringer If you turn the ringer off in silent mode, a ring alerts you when you receive fax or voice call and a call request.

Alarm If you disable the alarm in silent mode, the sound your machine makes when an error occurs and the beep your machine makes after sending or receiving a fax or making a copy cannot be heard.

Key tone If you mute the key tone, your machine will not make a sound when you press the buttons on the control panel.

- 1 Press **Program key, B, 1, 0, 4, ENTER**. The LCD shows your fax's current setting:

```
Silent Mode      :Off
  ← / → / Enter
```

- 2 Press **◀** or **▶** until the mode you want appears. In this example, we've chosen *On*.

```
Silent Mode      :On
  ← / → / Enter
```

Note: If you chose *On*, the silent mode of *Ringer*, *Alarm* or *Key tone* can be set to be available. If you chose *Off*, the machine will ring and beep as usual.

If you chose *Off*, skip to step 10.

- 3 Press **ENTER** to save the setting. The LCD now asks if you want the ringer to be on or off:

```
Ringer Silent    :Off
  ← / → / Enter
```

- 4 Press **◀** or **▶** until the mode you want appears.

If you want to turn off the ringer, select *On* and the machine will be quiet. Otherwise, the machine will ring.

- 5 Press **ENTER** to save the setting. The LCD now asks if you want the alarm turned on or off:

```
Alarm Silent     :Off
  ← / → / Enter
```

- 6 Press **◀** or **▶** until the mode you want appears.

If you want to turn off the alarm, select *On* and the machine will be quiet. Otherwise, the machine will beep.

- 7 Press **ENTER** to save the setting. The LCD now asks if you want the key tones on or off:

```
KeyBuzzer Silent :Off
  ← / → / Enter
```

- 8 Press **◀** or **▶** until the mode you want appears.

If you want to turn off the tones, select *On* and the machine will be quiet. Otherwise, the machine will beep when the keys are pressed.

- 9 Press **ENTER** to save the setting.

If you turned off the alarm or the key tones in the steps above, your machine gives you the option of setting the volume for the alarm and key tones. If this option appears, skip to step 10.

If you didn't turn any of these off, your fax machine returns to standby mode.

- 10 The LCD shows your fax's current setting:

```
Alarm&Key Volume :Mid
  ← / → / Enter
```

- 11 Press **◀** or **▶** until the mode you want appears. Below are the possible settings:

```
Alarm&Key Volume :Max
  ← / → / Enter
```

 = Loudest setting.

```
Alarm&Key Volume :Mid
  ← / → / Enter
```

 = Medium setting.

```
Alarm&Key Volume:Min
←/→/Enter
```

= Low setting.

12 Press **ENTER** to save the setting.

Setting Sleep mode (Energy saving mode)

Default setting: 30 minutes.

Your machine is initially set to be in the Sleep mode automatically when 30 minutes has passed after you pressed any key last.

Note: All LED lamps on the control panel will not be off, even when the machine is in the Printer sleep mode.

If you want to change the time or to set the Sleep mode to OFF, you can set it here.

1 Press **Program key, B, 1, 0, 5, ENTER**.

```
Sleep Mode      :On
←/→/Enter
```

2 Press **◀** or **▶** until the mode you want appears.
In this example, we've chosen *On*.

```
Sleep Mode      :On
←/→/Enter
```

If you chose *On*, proceed to step 3.
If you chose *Off*, skip to step 4

3 Press **ENTER** to save the setting. The LCD now asks you to enter the time for the Sleep mode using numeric keypad (1 - 120 min.).

```
Sleep Mode Timing
(001-120): 030
```

Note: Your machine will be in the Sleep mode when the time you set has passed after you pressed any key last.

4 Press **ENTER** to save the setting.

Primary mode

Default setting: None.

You can set the primary standby mode in this operation. After finishing any jobs, your machine will return to the mode you set here immediately.

1 Press **Program key, B, 1, 0, 7, ENTER**.

```
Primary Mode    :None
←/→/Enter
```

2 Press **◀** or **▶** until the mode you want appears.
In this example, we've chosen *Copy*.

```
Primary Mode    :Copy
←/→/Enter
```

3 Press **ENTER** to save the setting.

Setting 2-bin tray (Option)

Default setting: Copy exit: Lower tray, Fax exit: Upper tray, List exit: Upper tray, PC-Fax exit: Upper tray

You will set where to exit the printed paper in this operation.

Note: This operation will appear only when your machine has the optional 2-bin tray unit.

1 Press **Program key, B, 1, 0, 9, ENTER**.

```
2-Bin Tray     :Off
←/→/Enter
```

2 Press **◀** or **▶** until the mode you want appears.
In this example, we've chosen *On*.

```
2-Bin Tray     :On
←/→/Enter
```

If you chose *On*, proceed to step 3.
If you chose *Off*, skip to step 7.

Changing the default settings

- 3** Press **ENTER**. The LCD asks you to select Lower or Upper tray for copy exit. Press **◀** or **▶** until the tray you want appears. In this example, we've chosen *Upper*.

```
Copy exit      :Upper
               ←/→/Enter
```

- 4** Press **ENTER** to save the setting. The LCD now asks you to select Lower or Upper tray for fax reception. Press **◀** or **▶** until the tray you want appears. In this example, we've chosen *Lower*.

```
Fax exit       :Lower
               ←/→/Enter
```

- 5** Press **ENTER** to save the setting. The LCD now asks you to select Lower or Upper tray for list printing. Press **◀** or **▶** until the tray you want appears. In this example, we've chosen *Lower*.

```
List exit      :Lower
               ←/→/Enter
```

If your machine has the optional RS-232C interface kit, proceed to step 6. Otherwise, skip to step 7.

- 6** The LCD now asks you to select Lower or Upper tray for PC printing. Press **◀** or **▶** until the tray you want appears. In this example, we've chosen *Lower*.

```
PC-FAX exit   :Lower
               ←/→/Enter
```

- 7** Press **ENTER** to save the setting.

Printing your settings

After you've programmed settings into your machine, print a *settings list*. We recommend this, particularly if you're sharing the machine with other users, who might change the settings.

With this list, you can quickly confirm that all of your settings are correct, without having to go back and check them on the machine. Or, if you *do* need to undo someone else's changes, this list guides you in returning the machine to your preferred settings.

Settings are divided into three; Machine Settings, Fax Settings and Copy Settings.

To print the Machine settings list, press **Program key, E, 1, 0, 1, ENTER**. The LCD will show the following as the list prints:

```
Machine Settings
** Printing **
```

To print the Fax settings list, press **Program key, E, 1, 0, 2, ENTER**. The LCD will show the following as the list prints:

```
Fax Settings
** Printing **
```

To print the Copy settings list, press **Program key, E, 1, 0, 3, ENTER**. The LCD will show the following as the list prints:

```
Copy Settings
** Printing **
```

Note: Please refer to the index at the end of these instructions to locate any settings you don't recognize or understand.

Printing a program list

Your machine can also print a *program list*. This lists the functions available on your fax machine and the keystrokes needed to complete them. (See also Function Table, pages 1.14–1.17.)

To print a program list, press **Program key, *, 8**.

Printer options

Note: These options appear only if the optional printer controller has been installed.

Print the Demo Page

The demo page provides a demonstration that highlights the features and functions of the printer.

To print the demo page:

- 1 Press **Program key, E, 2, 0, 1**.

```
01 Demo Page
  ←/→/Enter
```

- 2 Press **ENTER** to print the demo page.

Print the Printer Configuration Page

The printer configuration page provides all the status and configuration of the printer.

To print the printer configuration page:

- 1 Press **Program key, E, 2, 0, 2**.

```
02 Status Page
  ←/→/Enter
```

- 2 Press **ENTER** to print the printer configuration page.

Print PCL Font List

The PCL font list provides a list of all PCL fonts currently installed in the printer.

To print the PCL font list:

- 1 Press **Program key, E, 2, 0, 3**.

```
03 Font List
  ←/→/Enter
```

- 2 Press **ENTER** to print the PCL font list.

Print NIC status

Note: To access this function, the optional NIC (Network Interface Card) is required.

To print the NIC status:

- 1 Press **Program key, E, 2, 0, 4**.

```
04 NIC Status
  ←/→/Enter
```

- 2 Press **ENTER** to print the NIC status.

Set TCP/IP Address

Note: To access this function, the optional NIC (Network Interface Card) is required.

When you using the TCP/IP protocol, enter an IP Address, Subnet mask and default Gateway.

To print the PCL font list:

- 1 Press **Program key, B, 4, 0, 1**.

```
01 TCP/IP
  ←/→/Enter
```

- 2 Press **ENTER**. The LCD will show:

```
Set IP Address
  000.000.000.000
```

- 3 Enter the IP Address for your printer using the numeric keypad, then press **ENTER** to save the setting.
For example, your printer's IP Address is 200.1.37.47, you should press **2 0 0 0 1 0 3 7 0 4 7**.

Changing the default settings

4 Press **ENTER**. The LCD will show:

```
Set Subnet Mask
 000.000.000.000
```

5 Enter Subnet Mask address.

6 Press **ENTER**. The LCD will show:

```
Set Default Gateway
 000.000.000.000
```

7 Enter default Gateway.

8 Press **ENTER** to save the setting. The machine will return to standby mode.

9 To effect the TCP/IP setting, turn the machine off and then turn on.

This page intentionally blank.

Just in case

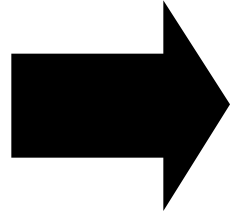

Tips on caring for your machine

What to do if problems occur

Glossary

Clearing paper jams	5.1
Print quality problems	5.3
Troubleshooting	5.5
Caring for your fax machine	5.12
Common questions	5.14
Glossary	5.17

Clearing paper jams

If an original document jams

- 1 If an original document jams in the ADF while scanning the document into the memory for faxing or copying, the LCD will show:

```
Document Jam
ContStor Enter/Cancel
```

If you do wish to continue the operation, press **ENTER** and proceed to step 2.

To abort the operation, press **CANCEL**. This will erase from memory all pages stored during this operation, and the machine will return to standby mode.

Important: If you wait more than 60 seconds without pressing any key, the machine will erase from memory all pages stored during this operation and the machine will return to the standby mode.

Note: If the document jammed in the following case, the following message will appear and the machine will abort the operation anyway; instead, you'll have to perform the job again from scratch.

The first page of the document jammed
During the real time transmission or quick memory transmission
During non-sorting ADF job

```
Open&Close ScanCover
Reset Document
```

Also, the Repeat transmission. Error on scan at page xx message will be printed out if the document jammed during transmission.

- 2 The LCD will show which page (i. e., which page number) is jammed. To continue scanning from the jammed page forward (keeping in mind the Note at the end of step 1, above), press **START** after clearing the jam.

```
p 2. Reset Document
Press Start Key
```

Note: If you wait more than 60 seconds without pressing any key, the machine will begin to send or copy the document(s) it has.

If you wish to cancel this operation, press **STOP**. The machine will delete all pages from memory and then return to its standby mode.

To remove the document:

- 1 Open the scanner cover.

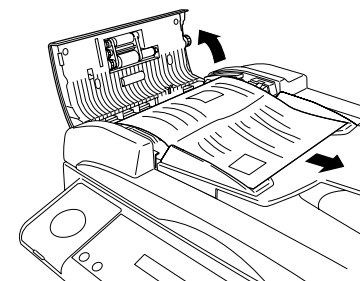

- 2 Lift the original document from the machine.

Note: If you cannot remove the original document, open the inner cover as shown at right, then remove the document.

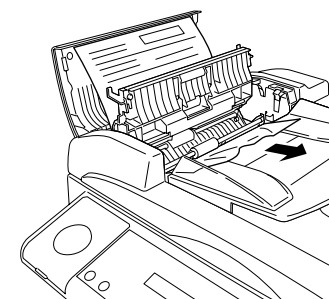

- 3 Gently close the scanner cover, making sure both sides are snapped down securely.

Note: If the original document has become wrinkled or torn, do not re-send it.

If a printout jams inside your machine

To clear a printout jammed inside your machine:

Important: Be careful not to put your hand between the top cover and the machine.

1 Open the top cover.

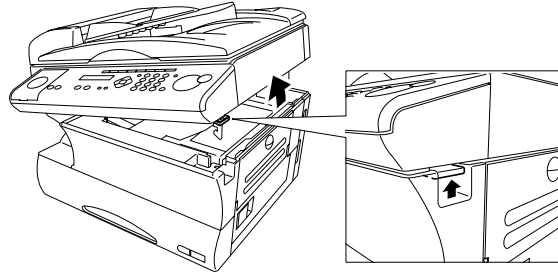

2 Open the printer cover.

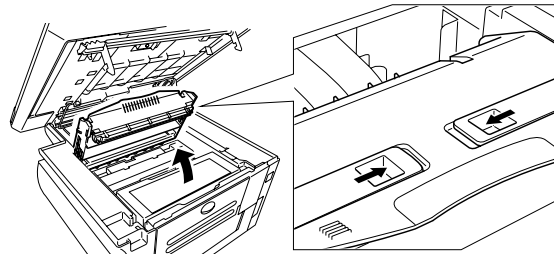

3 Remove the toner and drum cartridge.

Important: Shield the drum cartridge from light, especially strong light. Later, if you have to remove the cartridge from the fax, immediately wrap it in a thick cloth to protect it from light.

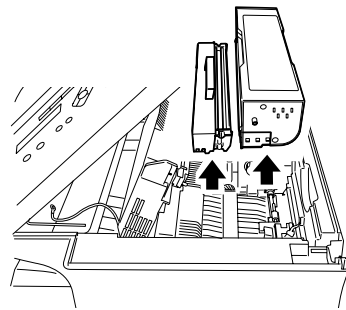

4 Remove the jammed paper.

Important: The fuser unit becomes very hot.
Do not touch the fuser unit when you are removing a paper jam.

Note: Avoid getting unfixed toner on your hands and clothes.

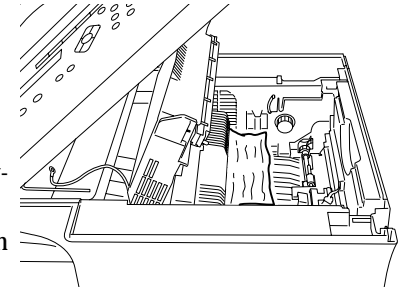

Open the side cover.
Pulling up the jam release lever to remove the jammed paper.

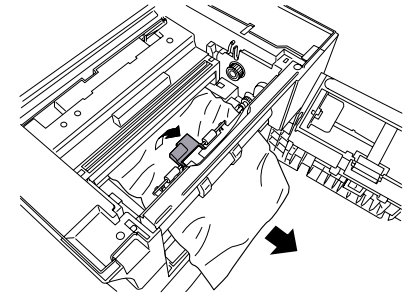

5 Reset the toner and drum cartridge.

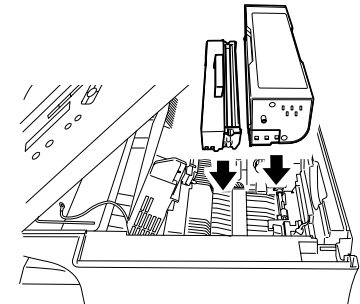

6 Gently close the printer cover, pressing firmly on the both sides of the printer cover until you hear it click.

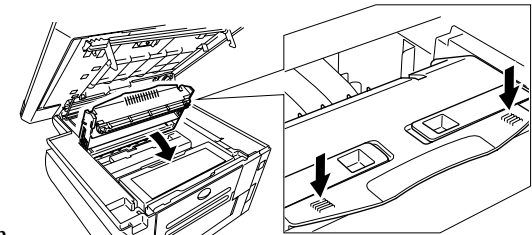

7 Gently close the top cover, pressing firmly on the both sides of the top cover until you hear it click.

Print quality problems

If your machine's printouts develop quality problems, try to find the example below that matches your printout problem. When you find one which is like yours, try the suggested solutions. If they don't work, contact your authorized Muratec dealer.



Pages are blank

The drum cartridge or toner cartridge may not be installed correctly.

Install each cartridge correctly.

The toner cartridge may be out of toner, or the toner may be very low.

Remove the toner cartridge and shake it a few times to redistribute the toner inside.

If the problem persists, replace the toner cartridge.

The toner cartridge may be defective.

Remove the toner cartridge and check it for damage.

If the problem persists, replace the toner cartridge.

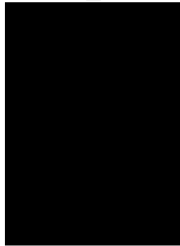

Pages are black

The toner cartridge may be defective.

Remove the toner cartridge and check it for damage.

If the problem persists, replace the toner cartridge.

Your fax machine's printer may be due for a service check.

Call your dealer.

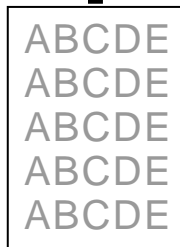

Printouts are too light

The toner cartridge may be out of toner, or the toner may be very low.

Remove the toner cartridge and shake it a few times to redistribute the toner inside.

If the problem persists, replace the toner cartridge.

The toner cartridge may be defective.

Remove the toner cartridge and check it for damage.

If the problem persists, replace the toner cartridge.



Printouts are too dark

The toner cartridge may be defective.

Remove the toner cartridge and check it for damage.

If the problem persists, replace the toner cartridge.

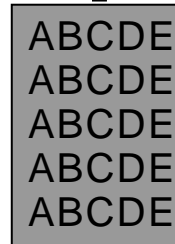

Printouts have a blurred background

The toner cartridge may be defective.

Remove the toner cartridge and check it for damage.

If the problem persists, replace the toner cartridge.

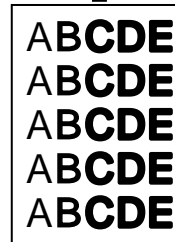

Printouts are of uneven density

The toner may be unevenly distributed inside the toner cartridge.

Remove the toner cartridge and shake it a few times to redistribute the toner inside.

The drum cartridge may be defective.

Remove the drum cartridge and check it for damage.

If the problem persists, replace the drum cartridge.

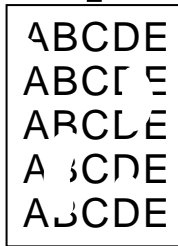

Printouts have irregularities

The paper you re using may have absorbed moisture, perhaps due either to high humidity or water having been spilled on the paper supply. Toner will not adhere well to wet paper.

Replace the paper with dry paper and try printing again.

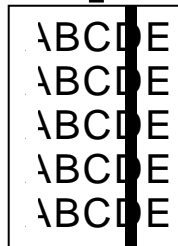

Printouts have white and/or black lines

The toner cartridge or drum cartridge may be defective. *Remove the cartridges and check them for damage. If the problem persists, replace either or both of the cartridges as indicated.*

The LED print head may be dirty. *Using the cleaning paper, gently clean the LED print head.*

The charger may be dirty. *Your machine normally cleans the charger automatically. If other solutions fail, please contact your authorized Muratec dealer.*

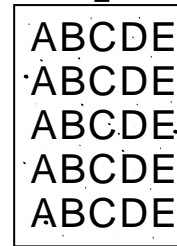

Printouts have toner smudges

The toner may be unevenly distributed inside the toner cartridge.

Remove the toner cartridge and shake it a few times to redistribute the toner inside. If the problem persists, replace the cartridge.

The toner cartridge or drum cartridge may be defective. *Remove the cartridges and check them for damage. If the problem persists, replace either or both of the cartridges as indicated.*

If you find smudges on the *back* of the printouts, the transport roller may be dirty.

Your machine normally cleans the transport roller automatically. If other solutions fail, please contact your authorized Muratec dealer.

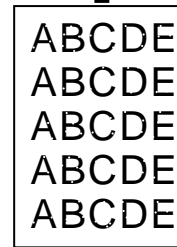

Printouts have white spots

The charger may be dirty. *Your machine normally cleans the charger automatically. If other solutions fail, please contact your authorized Muratec dealer.*

Troubleshooting

Occasionally, your fax machine encounters some trouble transmitting or receiving documents. When it does, it alerts you with an alarm. You can identify the problem with LCD messages and printed *check messages* and *error reports*, explained in the following pages.

Alarm

Your fax machine sounds an alarm tone a series of short beeps if either of these two problems occur:

- Trouble transmitting or receiving
- The machine is out of paper

LCD error messages

What you see on the LCD

What it means/What to do

All Commands In Use

Your fax machine has all of its 99 possible delayed commands (automatic redialing counts as one) stored in memory and cannot accept another. *Wait until your fax has completed one of the delayed commands or delete an existing command by using REVIEW COMMANDS.*

Already Stored

You tried to enter the same fax (or phone) number which is already entered in your fax machine.
Enter a different fax (or phone) number.

Box In Use

You tried to erase a F-Code box which contains at least one document.
Erase the document(s), then try again.

Call For Service

The scanner lamp is dim or inoperable. Make repeated copies to help evaporate any internal moisture. *If that doesn't resolve the problem, call your authorized Muratec dealer or Muratec Customer Support.*

What you see on the LCD

Change to Fax Mode

What it means/What to do

You tried to store the document for polling (or for F-Code Box) when the machine is in the Copy mode. You can store the fax document only when the machine is in the Fax mode.

Check Memory Tx

You tried to turn the Fax&Copy feature ON, but the memory transmission setting is OFF. To use the Fax&Copy feature, the memory transmission setting must be set to ON.
Set the Memory Tx to ON, then try again.

Check Paper Size Open&Close Top Cover

The difference sized paper which is not same sized paper you told your machine is loaded.
Set correct sized paper or change the paper size setting (see page 1.9 1.10).

Close Scanner Cover

The cover indicated on the LCD is open or has not been closed securely. *Close it properly.*

Close Top Cover

Close 1st Side Cover

Close 2nd Side Cover

Close 1st Cassette

Close 2nd Cassette

The paper cassette indicated on the LCD is open or has not been closed securely. *Close it properly.*

Communication Error

A communication error disrupted the reception or transmission. *If you were transmitting, press STOP to clear the error message and then re-try the transmission. If you were receiving a fax, try to contact the other person and have him/her re-try the transmission. (The problem may be entirely with his/her machine, phone line, etc.)*

Copy Off

You tried to change your fax machine to the copy mode, but the unit's copy protection feature (page 2.18) is on, preventing such use. *Turn off copy protection.*

Department Code Full

You tried to enter department code more than 100. Your machine can store up to 100 department codes.

Just in case

What you see on the LCD

Document Full

What it means/What to do

You tried to enter a document into an F-Code box, but the machine has reached its capacity (30 documents). *Delete documents stored in F-Code boxes until the machine will let you proceed.*

Document Jam ContStor Enter/Cancl

An original document jam while you are using the ADF for either faxing or copying. *See page 5.1 for instructions on clearing the jam.*

Document Stored

You tried to erase a batch box which contains at least one document. *Erase the document(s), then try again.*

Enter No. (0-32)

You tried to enter a call group number greater than 32. Your machine can maintain 32 call groups, numbered 1-32 (call group 0 covers all the groups). *Determine the correct call group identifier number and enter it, instead.*

Enter No. (000-255)

If the optional NIC (network interface card) is attached to your machine, and you tried to enter a TCP/IP address greater than 255. *Enter the correct TCP/IP address.*

Enter Reduce/Enlarge

You tried to copy your document on the paper other than Letter, Legal or Half letter sized paper using the bypass tray, or the calculated reduction or enlargement ratio is out of the acceptable range (50 - 200 %) when the copy reduction or enlargement ratio is set to Auto. *Enter the reduction or enlargement ratio manually although a part of the image might be lacked, or change the paper for copying.*

Enter Scan Size

When you using the FBS (Flatbed scanner) glass, you must manually enter the scan size of your document. *Press DOCUMENT SIZE to choose the size.*

Feeder In Use

The command you re trying to enter requires the use of the ADF, which is already in use. *Wait for the machine to stop using the ADF, then try again.*

What you see on the LCD

Hang Up Phone

What it means/What to do

The optional handset is off-hook. *Hang it up, making sure the upper part of the handset presses down on the hook button.*

In Relay Box

You tried to store a document for polling in an F-Code box which is set to be a relay box. *Select an F-Code box which is set to be a bulletin box, then try again.*

In Secure Box

You tried to store a document for polling in an F-Code box which is set to be a security box. *Select an F-Code box which is set to be a bulletin box, then try again.*

In Use in P OneTouch

You tried to erase the F-Code box or Batch box, which is programmed in the programmable one-touch key. *Erase the programmable one-touch key that contains the F-Code box or Batch box you want to erase, then try again.*

Invalid I.D. Code

The F-Code box I.D. code you entered isn t valid. *Try re-entering your F-Code box I.D. code.*

Invalid Number

You pressed a key which has no function during the current operation.

Invalid Paper Size

If the optional printer controller is attached to your machine, it can use the special sized paper with the bypass tray. However, it should be used only for the PC printing, it cannot be used for copying. So, if you tried to copy onto the special sized paper with bypass tray, this message will appear.

Invalid Passcode

The protection passcode you entered isn t valid. *Repeat the operation, entering the correct protection passcode.*

Line Busy

You tried to erase a document which someone is polling from your machine. *Wait for the fax to complete the polling operation, then try again.*

<i>What you see on the LCD</i>	<i>What it means/What to do</i>	<i>What you see on the LCD</i>	<i>What it means/What to do</i>
Macro In Use	You tried to change the function for a Soft key, but that Soft key has been programmed in a Macro key. You cannot change the Soft key function until erase the Macro key that contains the Soft key you want to change. <i>Erase the Macro key, then try again.</i>	No Passcode	You tried to program a security feature (see page 3.50), but there s no protection passcode stored in your fax machine. <i>Store a protection passcode in your machine, then retry again.</i>
Memory Overflow Start Or Cancel	During transmission (or copying), you tried to enter more pages into memory than your fax could store. <i>Press START to tell your fax to keep as many pages in memory as possible, or press CANCEL to delete from memory all pages stored during this operation (but not previous operations).</i>	No PIN Number	You selected Mode1 in the PIN mask feature and tried to call an autodialer number in which no PIN has been entered, or to call using numeric keypad without PIN. <i>Enter a PIN, then try again.</i>
Mirror Carriage Error	The mirror carriage of your machine has become inoperable. <i>Call your authorized Muratec dealer or Muratec Customer Support.</i>	No Report	You requested an activity journal or confirmation report, but your fax machine has no record of any fax jobs having occurred.
Mirror Locked	The transport mode is not turned off. <i>Turn off the transport mode (see page 1.8).</i>	No Toner Cartridge	The toner cartridge is missing or has not been properly installed in your fax machine. <i>Please properly install the toner cartridge.</i>
No Command	You pressed REVIEW COMMANDS to review upcoming commands, but your fax machine had none stored.	Not Allowed in Macro	During macro registration, you pressed the key which cannot be registered in Macro, such as Monitor/Call key or Security Reception key.
No Department Code	You tried to turn on the department code setting but there are no department codes stored in your fax machine. <i>Store at least one department code, then try again.</i> <i>... or ...</i> You entered incorrect department code at fax sending while the department feature is on. <i>Enter correct department code.</i>	Other Key Setting	You tried to enter the same function which is already stored in other Soft key. <i>Store the different function.</i>
No Document Stored	You tried to print a document from memory, but your fax machine had none stored.	Open Top Cover Please Remove Paper Open 1st Side Cover Please Remove Paper Open 2nd Side Cover Please Remove Paper Open Top/2-Bin Cover Please Remove Paper Remove Bypass Paper Open&Close Top Cover	The paper is jammed in your fax machine. <i>Open the cover indicated on the LCD, and remove the jammed paper carefully.</i>
No Drum	The drum cartridge is missing or has not been properly installed in your fax machine. <i>Please properly install the drum cartridge.</i>	Open&Close ScanCover Reset Document	Either your document wasn t inserted correctly, or the fax to which you re sending can t handle the document s page length. <i>Reset the page and try again.</i>
No Number Stored	You selected an autodialer, batch box or F-Code box number for which there is no fax (or phone) number programmed. <i>Either choose another number or dial a phone number directly from the numeric keypad.</i>	Please Call Service	The printer unit of your fax machine has become inoperable. <i>Call your authorized Muratec dealer or Muratec Customer Support.</i>

Just in case

<i>What you see on the LCD</i>	<i>What it means/What to do</i>
Please Supply Paper	The paper cassette or bypass tray is out of paper. <i>Supply paper to the cassette and/or the bypass tray.</i>
Please Wait	Your fax machine s printer is either warming up or busy. <i>Please wait until the fax is finished printing and then re-try your command or operation.</i>
Polling In Use	You tried to store the polling document in your fax machine, where one already had been stored. <i>Wait for the fax to complete the regular polling operation or delete the stored document, then try again.</i>
Printer In Use	The command you re trying to enter requires the use of the printer, which is already in use. <i>Wait for the fax to finish printing, then try again.</i>
Protect Doc. Stored	A received document was in your fax s memory when you tried to turn off the security reception passcode. <i>Print the received document from your fax s memory, then retry the desired operation.</i>
Ration must be 100%	You cannot set the magnification ratio in Negative/Positive copy or Ultra copy mode. <i>Set the magnification ratio to 100 % to use the Negative/Positive copy or Ultra copy mode.</i>
REPLACE DRUM SOON 500 PRINTS REMAIN	Your machine can print about 500 more sheets, but your drum will need to be replaced soon. <i>Please contact your authorized Muratec dealer to purchase a new drum cartridge if you don t already have one.</i>
REPLACE DRUM UNIT PRINTER NOT USABLE	Your drum cartridge doesn t work. Your machine cannot print until it is replaced with a new drum cartridge. <i>Replace it.</i>
Scanner In Use	The command you re trying to enter requires the use of the scanner, which is already in use. <i>Wait for the fax to complete the scan, then re-try the desired command.</i>

<i>What you see on the LCD</i>	<i>What it means/What to do</i>
SecurityRx is Off	You tried to turn the security reception ON using a Soft key which is assigned to set the security reception to ON or OFF, but security reception setting has not set to on. <i>To turn on or off the security reception using a Soft key, first set the security reception setting to on. (See pages 3.50 3.51.)</i>
Select Paper Size	You tried to make a copy in the following conditions: Paper size selection is set to Auto . The bypass tray has the paper other than Letter, Legal, Half-letter. Paper cassette(s) runs out of paper. <i>Press PAPER SIZE to select your desired paper.</i>
Sub-address In Use	You tried to enter a sub-address identical to one already being used in another F-Code box. Enter a different sub-address.
TONER ALMOST EMPTY 50 PRINTS REMAIN	Your machine is almost out of toner. About 50 more sheets can be printed, but <i>please contact your authorized Muratec dealer soon to purchase a new toner cartridge if you don t already have one.</i>
TONER EMPTY PRINTER NOT USABLE	Your toner cartridge is empty. <i>Replace the toner cartridge. Your machine cannot print until it is replaced with a new toner cartridge.</i>
Too Many Characters	You attempted to enter too many numbers or other characters in the current operation. <i>Press CANCEL to delete the extra characters, then try again. You may wish to review the operation s appropriate instructions.</i>
Too Many Locations	You tried to enter too many numbers for a broadcast. You can enter up to 200 autodialer number and up to 30 numbers entered through the numeric keypad. <i>Press CANCEL to delete the extra numbers and then try again.</i>

What you see on the LCD

Too Many Steps

What it means/What to do

You tried to enter too many steps for a macro.
You can enter up to 60 steps into a macro key.

Unable to Reduce

In the reduction copy using the ADF, if the calculated ratio is smaller than minimum reduction ratio (50%), this message will appear and you cannot make the reduction copy.
Use the FBS glass, however parts of the image might not be copied.

Use FBS Glass

You tried to enlargement copy using the ADF. Your machine cannot enlargement copy from the ADF. *Please set your document on the FBS glass to make the enlargement copy.*

Errors

When sending faxes, your machine occasionally runs into *communications errors*. These can be caused by anything from lightning to telephone line interference. (These same factors cause the static, or *line noise*, you sometimes hear on phone calls.) They also can be caused by problems with the fax machine at the other end of the line.

Often, simply trying your call again is all that's necessary. However, *if the problem persists regularly*, call your local telephone company for help. If that doesn't help *and the problem persists regularly*, call your authorized Muratec dealer.

Error reports

When an error occurs, your fax machine prints an *error report*. Each fax error report lists an *error message* which includes:

- A possible *solution* to the problem
- The *sending location* (if the remote fax stores a Location ID of its own)
- The *result* which is a special *error code*.
- A *sample* of the document's first page.

Kinds of error codes

The error code listed in the **Result** column of the error report indicates the specific problem encountered:

- D** codes Occur while *dialing*
- R** codes Occur during *reception*
- T** codes Occur during *transmission*

Specific errors

Following are some error codes you may see on an error report:

Dialing errors

- D.0.3, The remote unit didn't respond, the call couldn't be completed or **STOP** was pressed during dialing. *Re-try the call. If your machine repeats the message, call the remote fax unit's operator and verify that unit is operating properly.*
- D.0.2 The remote unit is busy. *Try the call again.*
- D.0.6, Either the remote unit didn't respond, the call somehow didn't go through or
- D.0.7 **STOP** was pressed during dialing. *Try the call again.*

Just in case

Reception errors

- R.1.1 The calling fax machine didn't respond to your fax machine. This can happen if someone dials a wrong number or if the remote machine restricts access through use of a passcode.
- R.1.2 The two fax machines were incompatible. Your fax machine sends and receives only ITU-T Group 3 (see Glossary, page 5.18) fax communication, the industry standard since the early 1980s.
- R.1.4 Someone pressed **STOP** at the receiving fax machine.
- R.1.5 The fax machine didn't detect the silence at the end of the call for receiving an RCR.
- R.2.3 Poor phone line conditions made fax communication impossible. *Call someone at the remote machine's location.*
- R.3.1 The sending fax machine detected too many errors from the receiving fax machine.
- R.3.3 The sending fax machine is incompatible or had a document feeder problem during transmission.
- R.3.4 Poor phone line conditions may have prevented your fax machine from properly printing some or all of the pages it received.
- R.4.2 Either the line disconnected before transmission or the transmitting fax machine needs maintenance.
- R.4.4 The fax machine has reached its memory capacity.
- R.5.1, R.5.2 ECM reception failed (perhaps due to line noise).
- R.8.1 A compatibility error occurred.
- R.8.10 Line noise or other problems prevented line probing.
- R.8.11 The fax machine timed out while waiting for the retrain signal.

Transmission errors

- T.1.1 The remote fax machine didn't respond to your machine. *Call someone at the remote machine's location.*
- T.1.2 Your fax machine's page counter detected a possible document feeder error. *Carefully put the document back into the feeder and try the call again.*
- T.2.1 Either the phone line disconnected during transmission or fax communication became impossible due to bad phone line conditions. *Try the call again.*
- T.2.2 The two fax machines were incompatible. Your fax machine sends and receives only ITU-T Group 3 (see Glossary, page 5.18) fax communication, the industry standard since the early 1980s.

- T.2.3 Bad phone line conditions made fax communication impossible. *Conditions can change rapidly, so try the call again later.*
- T.3.1 The page counter in your fax machine detected a document feeder error during transmission. *Carefully re-insert the document into the feeder and re-try the call.*
- T.3.2 The fax machine didn't detect the silence indicating the call had ended.
- T.4.1 The telephone line disconnected during transmission because of excessive modem errors or because remote unit ran out of paper. *Try the call again.*
- T.4.2 After transmission began, poor line conditions developed. *Try the call again.*
- T.4.4 Poor line conditions prevented transmission. *Try the call again.*
- T.5.1, T.5.2, T.5.3 ECM transmission failed (perhaps due to line noise). *Conditions can change rapidly, so try the call again later.*
- T.8.1 A compatibility error occurred.
- T.8.10 Line noise or other problems prevented line probing.
- T.8.11 The remote fax machine didn't complete the equalizer training phase.

Check Message printouts

When there s a problem with a fax call and your machine detects an error, it produces an error printout headed by the words Check Message. This printout lists the following information about the transmission:

The resulting error code

A communications error message (see What error messages can mean, below)

The phone number (or TPI, if programmed) of the fax machine with which your machine had attempted to communicate.

What error messages can mean

The error messages on Check Message printouts can mean a variety of things. Here s a brief summary:

Error message	Possible meanings
Check condition of remote fax.	Remote machine malfunctioned No handshake signals from remote fax Wrong phone number reached
Repeat transmission.	Poor phone line conditions No handshake signals from remote fax Document misfeed or miscount Unable to reach remote machine after attempting specified number of redial tries
Line is busy.	Remote machine s line was busy Remote machine s line didn t answer
Check received documents.	Remote confirmation signal not received from remote fax Poor line conditions caused a poor image
Memory full.	Remote fax s memory is full
Dialing number is not set.	Stored phone number failed to dial properly
Stopped.	Someone pressed STOP at the remote fax in the middle of the handshake

Caring for your fax machine

With proper installation and a little maintenance, your fax machine should give you dependable service for years to come.

Although it requires little day-to-day care, you can take these simple precautions to keep it in top form:

Always make sure your fax machine is installed according to our specifications, including using an electrical surge suppressor. (If necessary, review Pick an installation spot, page 1.5.)

Always use good, copier-quality paper.

Always clean your fax machine as needed (see Cleaning tips, below).

Never install your fax machine where it can overheat, gather dust or get splashed by any liquids (even water).

Cleaning tips

Some things to keep in mind about cleaning your fax machine:

Do clean it! Dust and dirt, especially around the fax machine's air vents can shorten your machine's life.

Always unplug the fax machine *before* you clean it.

Never spray any cleaner DIRECTLY onto your fax machine. The drifting spray could damage components inside.

Never try to clean SEALED areas inside your fax machine. They're sealed to protect your safety and the machine.

For cleaning *external* surfaces, such as the cover and handset: use a mild cleaning solution sprayed onto a lint-free towel or cloth.

Always use a lint-free cloth (or swabs) moistened with alcohol to *gently* wipe components inside your machine.

In areas you can't reach with swabs, **always** use dry, dust-free compressed air to *gently* blow away dust and other material.

Corrective cleaning

Here are some simple cleaning procedures for keeping your fax machine operating smoothly. Use each as the need arises.

Curing frequent jams in the ADF

If you're having trouble with getting your original documents to feed properly, try this procedure:

- 1 Turn off your fax machine.
- 2 Get two soft, lint-free cloths and moisten them as follows:
 - One with a cleaner suitable for use on platen/rubber rollers. In steps 4 and 6, we'll call this the rollers cleaner.
 - The other with isopropyl alcohol
- 3 Open the scanner cover by holding the scanner cover release.
Important: You must hold the cover open. It won't stay open by itself.
- 4 Use the cloth with the rollers cleaner to clean the face of the rollers. Rotate the rollers by hand to allow cleaning of the entire roller surface.

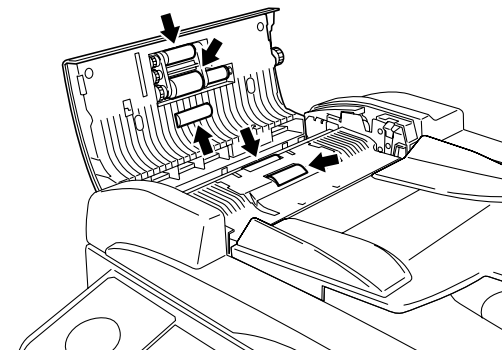

- 5** Open the inner cover fully.

Important: You must hold the cover open. It won't stay open by itself.

- 6** Use the cloth with the rollers cleaner to clean the face of the rollers. Rotate the rollers by hand to allow cleaning of the entire roller surface.

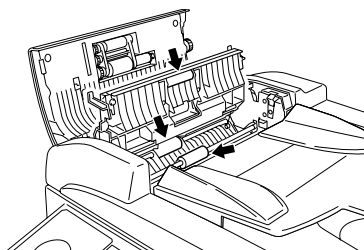

Cleaning the FBS glass, Contact glass and white pad

- 1** Open the platen cover.

- 2** Get a soft, lint-free cloth and moisten it with isopropyl alcohol.

Important: Make sure the cloth doesn't have any rough areas. Otherwise, it could scratch the glass surface of the FBS.

- 3** Using the cloth, gently clean the FBS glass, contact glass and the white background area on the underside of the platen cover.

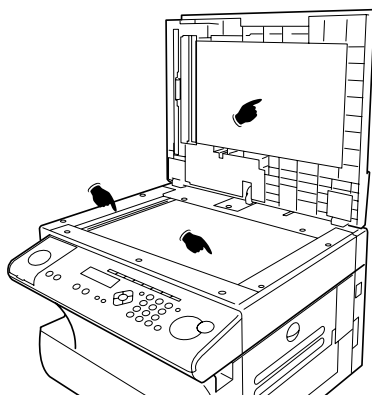

If you have unsatisfactory printout quality

Your machine automatically cleans its charger and transport roller, two items which are very important to printout quality. So, if you notice poor printout quality (whether on received faxes or on copies), it may mean that your machine requires service. Review Print quality problems (pages 5.3-5.4), and see whether any of the proposed solutions helps your machine. If none do, please call your authorized Muratec dealer or call the Muratec Customer Support Center at (800) 347-3296 (from the U.S. only).

Cleaning the LED print head

If you find your fax recipients complaining that the faxes you receive or copy image quality are streaked, the LED print head may be dirty.

Important: Be careful not to put your hand between the top cover and the machine.

- 1** Turn off your fax machine.

- 2** Get a soft, lint-free cloth and moisten it with isopropyl alcohol.

- 3** Open the top cover and then open the printer cover.

Important: The fuser unit becomes very hot. **Do not** touch the fuser unit when you are cleaning the LED print head.

- 4** Using the cloth, gently clean the LED print head.

Note: **Do not** use abrasive materials on the LED print head, and **do not** subject the LED print head to strongly shock.

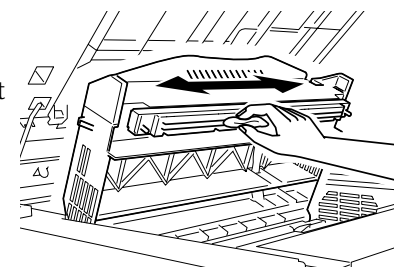

Common questions

We're here to help you!

The *Muratec Information System* is available to you 24 hours a day, 7 days a week. You can use your fax machine to call this fax-on-demand system and receive printouts of information, such as the most common questions asked about your machine. Often, *this* is the fastest way to find out the answer to any question you may have. And it's a free call!

To use the Muratec Information System:

- 1 On your fax machine, press **MONITOR/CALL** to get a dial tone, or lift your optional handset.
- 2 Call **1-800-215-1698**.
- 3 Follow the voice instructions you'll receive from the system.

General questions

- Q:** Where do I add ink or toner to make my fax machine's printouts darker?
- A:** *You can't adjust the darkness of an incoming fax printout, but you can adjust the darkness of a copy or of a transmission. Insert a document and press **CONTRAST** to adjust the contrast setting. Dark prints at the darkest setting. The machine will reset automatically to normal contrast after you finish copying or sending the fax.*
- Q:** When I unplug my machine or if the power goes off, will I lose the information I've stored—such as my TTI, autodialer entries, the time and date, etc.—and have to re-enter them?
- A:** No. There's a special battery built into your fax machine which protects user settings for several days if power fails or if you decide to move your machine. However, we do advise you to restore power to the machine as soon as possible.
- Q:** Can I use a dust cover on my fax machine?
- A:** No! A dust cover blocks air circulation, which could cause your machine to over-heat.

Sending faxes

- Q:** Sometimes, I try to send a fax while using either the optional handset or the **MONITOR/CALL** feature. But, when the other side answers, I hear a horrible screeching sound, so I hang up. What's happening?
- A:** That was the other fax machine trying to say Hello to your machine! You'll hear sounds like that any time you call a fax machine which is set to answer automatically (as when you set your machine to Auto Answer mode). It's by using these tones that fax machines are able to send faxes over ordinary phone lines. So, next time you hear the tones, press **START** (and, if you're using an optional handset, hang up) to send a fax.
- Q:** I just sent a fax. However, the number that appeared in my machine's display during the transmission wasn't the number I dialed. Why?
- A:** That number you saw is programmed into the remote fax machine by the user. Some users prefer different numbers to appear than the ones they're really using. And some people don't know how to change the number once it's set.
- Q:** Can I transmit and receive at the same time?
- A:** No. Use the call request feature (see pages 3.25-3.26) to ask the person at the remote fax machine if he or she wants to transmit or receive after your fax communication is complete.
- Q:** Do I have to dial a 1 for a long-distance call?
- A:** Yes. Dialing a fax number is just like dialing any other phone number, so be sure to include any special long-distance codes or dialing pauses when dialing. Also, remember to include them when you set your autodialer numbers.
- Q:** How do I send a fax to an overseas telephone number?
- A:** Dialing requirements for international calls may vary depending on your local telephone company's requirements. For most international calls, call 011, then dial the appropriate country code, city code and phone number. (You may find country and city codes in the front section of your telephone directory.)
- Q:** Can I transmit if my fax machine runs out of paper?
- A:** Yes, but confirmation reports (see page 3.22) aren't available when you transmit without recording paper in your fax machine.

- Q:** Can I transmit a document that's extra long?
- A:** Yes, *if* the receiving fax machine is equipped to handle long documents. Many machines have a special setting which allows them to receive documents that exceed the normal length.
- Q:** Can I transmit a page from a newspaper?
- A:** No. A newspaper page can jam in your document feeder. First, use a copy machine to make an appropriately sized copy of the newspaper page, then transmit the copy.
- Q:** Can I transmit a page with correction fluid on it?
- A:** Yes, but only if the fluid is *completely dry* before you begin transmission.
- Q:** How can I be sure my fax was received?
- A:** Set your machine to print a confirmation report after each transmission (see pages 3.23).
- Q:** I don't want to install a dedicated phone line for my fax machine, so I've connected the machine to a PBX phone system. When I get a fax call, *all* the phones ring. How do I prevent this?
- A:** Call your PBX manufacturer or telephone company for assistance. They may be able to convert one of the PBX lines for use only by your fax machine.
- Q:** Sometimes when I dial a fax call by using either the optional handset or **MONITOR/CALL**, I don't hear the fax receiving tones from the other machine. Am I doing something wrong?
- A:** When this happens, try pressing **START** (and then hanging up the optional handset if you're using it), as usual. It's possible you're calling an older, non-standard fax machine that *doesn't* emit answering tones. Even a few Group 3 faxes (see *Glossary*, page 5.18) on the market sound a *sending* tone but don't sound a *receiving* tone. After you transmit, call the person at the other fax machine's location to see if that person got your document.
- Q:** I inserted a document in the feeder and dialed a fax number, but my machine didn't transmit the document. Instead, **** Auto Redial **** now appears on my LCD. What does this mean?
- A:** The remote fax machine was busy, so your machine will try the call again, automatically. As long as it hasn't stored more than 99 delayed commands (counting automatic redials), your machine should still accept commands from you. If it has exceeded this quantity and will accept no more commands, try canceling one of the delayed commands (see page 2.8). If the machine *still* won't cooperate, keep canceling commands until it does.

- Q:** The specifications (page AI.1) list an average per-page transmission time, but when I transmit a page it can take much longer. Why?
- A:** We base this specification on transmission of an industry-standard test document called *ITU-T Test Document 1* (sometimes also called the Slerexe letter). Fax manufacturers use this method to test transmission speeds. However:
- The pages you send may be darker, or otherwise contain more information, than ITU-T Test Document 1.
- The transmission time measured for test documents doesn't include *handshake time*—the time during which two fax machines introduce themselves to each other and agree on the parameters of the call.
- The specification time is based on the use of normal resolution mode. You may be using fine, superfine or grayscale transmission, each of which takes longer than normal mode.
- Q:** What's a *default*?
- A:** A default is a setting that your machine will always refer to if nothing else is programmed. For example, you can set the default for this machine to send a fax by using its memory. If you set this action as the default, that's how your machine will always send a fax, until you tell it to do differently.

Reports

- Q:** I called the number *011-555-555-1212*, but not all of the digits appear on my transmit confirmation report (TCR). Why didn't the whole number appear? How can I be sure my document went to the right location?
- A:** The numbers you enter using the fax keypad are temporarily stored in a memory buffer, and it's only the last part of the phone number that the buffer remembers. An easy way to avoid getting incomplete telephone numbers on your printouts is to store your most frequently used numbers as one-touch keys or speed-dial numbers. These autodialer numbers will appear in their entirety on your TCR.

Receiving faxes

- Q:** My fax never answers. What's wrong?
- A:** Check to make sure your fax machine is properly connected to a working AC power outlet and phone jack (see page 1.7). If you're using a second phone with your machine, make sure it's connected properly (page 2.20).
- Q:** Sometimes when I answer my machine with the optional handset, I hear a beeping sound that repeats every few seconds. Is this a fax?
- A:** Yes. When you hear these *fax tones*, someone is trying to send you a fax. Next time, press **START** and hang up the handset. Your fax will receive the message.
- Q:** Does my fax machine have to be plugged in to the AC power jack to receive a message?
- A:** Yes. Your phone will ring if the phone line is connected, but you can't receive a fax unless your fax machine is plugged into both the phone jack and the AC power jack. Make sure your fax machine is always plugged in so you never miss an important fax message.
- Q:** Can I receive a fax if I'm using the phone on my machine?
- A:** You can receive a fax from the person to whom you're talking. When that person has a document ready in his/her machine's feeder, press **START**.

Working with your answering machine

- Q:** People have complained that they call my fax machine and hear my answering machine's message, but are cut off before they can send a fax. What happened?
- A:** Any remote fax machine attempting to send a fax must hear responding fax tones within 40 seconds after the person at that machine presses the start key. That 40 seconds includes getting the dial tone, dialing the number, listening to the pause before the ringing starts and the remote fax machine answering the ring. Only after that time does your message play. That's why we urge you to create a short outgoing message. The shorter the waiting period, the more likely it is that the remote fax machine will proceed with the transmission. Please create an outgoing message on your answering machine that's no longer than 10 seconds (see page 2.11 for a suggestion).

Polling

- Q:** What's the purpose of polling?
- A:** Polling lets you automatically pull a document which is set in another fax machine. You can poll whenever you need to retrieve information and don't want the source to pay for the phone call. With polling, you pay for the call and get the information you need.

How your fax machine works

How a fax machine works is simple:

You put a page into your fax machine's feeder and call a fax number. Your machine makes a satisfactory connection with the other machine, and then

Your machine takes the document.

An image scanner in your fax machine examines the information on the page.

Your machine wraps the document.

Your fax machine translates the scanned information into a numeric code and compresses the code for the fastest possible transmission speed.

Your machine sends the document.

Finally, your fax machine sends the compressed code.

On the other end of the line

The remote fax machine *receives* the code.

Your machine *unwraps* the document.

The remote fax machine uncompresses and deciphers the code, turning it into a representation of the scan your machine made.

The remote fax machine prints the representation.

The only difference between a regular telephone call and a fax call is the *content* of the transmission:

On a regular call, your telephone sends your voice.

On a fax call, your fax machine sends a coded image.

The way fax machines work is regulated closely by the International Telecommunications Union (ITU), an agency of the United Nations. The standards the ITU applies ensure the compatibility of your fax machine with millions of other machines worldwide. However, they also limit the way you can use your machine with other devices, such as telephones and answering machines.

Glossary

This glossary contains terms you may encounter when discussing or reading about fax machines. Please use these definitions for reference only. A list of definitions can also be found on the Muratec website at www.muratec.com.

24-hour format Also called *military format*. A format for keeping time that does not use a.m. or p.m. to distinguish between morning and afternoon. In the 24-hour format, one o'clock in the morning marks 1:00, noon marks 12:00 and midnight marks 24:00. To calculate the 24-hour format, add 12 hours to all times after noon.

For example, 1:30 p.m. would be 13:30 in the 24-hour format; 10:45 p.m. would be 22:45 in the 24-hour format. And 11:15 a.m. would be 11:15 in the 24-hour format.

A3, A4, B4 Standard stationery sizes defined by the International Standards Organization, an agency of the United Nations. See also *Paper sizes*.

ADF Automatic document feeder. See *document feeder*.

Alternate number The number your machine dials after all attempts to the regular number fail. The user programs this alternate number, if so desired.

Answering machine See *TAD*.

Autodialing Enables user to store preprogrammed telephone numbers in the unit's memory. Storage capability varies from unit to unit.

Automatic fallback The ability of a fax machine to slow down (fall back), when communicating with another fax which is communicating at a slower rate.

Automatic reduction Many Muratec fax machines will automatically reduce the size of documents being transmitted to accommodate the effective printing width of the receiving unit. For example, this allows a fax machine with a 10" (256 mm) scanning width to send an image 10" (256 mm) wide to a unit with an 8.3" (210 mm) print width. The receiving fax machine will receive a reduced-size printout of the complete image.

Bit The smallest unit of information in a computer. Some Muratec fax machines, which are actually computers dedicated to telecommunications, allow users to change bits of information to provide or cancel features through software settings.

Bits per second See *bps*.

Black density Also called *black coverage*. The amount of non-white area on a page. For example, most regular office correspondence has a black density well under 10%, due to the presence of margins, spaces between words, spaces between lines and paragraphs and even spaces within letters. However, drawings and photographs have a much higher black density, sometimes approaching 100%. The higher a page's black density, the more slowly a fax machine sends it.

Broadcast A fax transmission in which a single document is sent to more than one location.

bps Bits per second. Used to express the speed of transmission of data. Because fax transmission treats a document as a graphic image rather than as a series of alphabetic and numeric characters, bps does not correspond to the number of characters transmitted per second.

Byte A group of digital elements, usually sent as eight bits to the byte.

Call reserve Also called *call request*. An ITU-T standard fax feature which allows a user to request voice communication prior to, during or after transmission.

Call-waiting service An optional telephone company service that alerts you to another incoming call when the phone is already in use. Call-waiting signals often cause interruption of fax transmission or reception.

Caller ID Optional service provided by your local telephone company that allows you to see a display of the number (phone or fax) that is calling.

CCITT See *ITU-T*.

CCD, CIS Charged coupled device, contact image sensor. Two types of scanning mechanisms used in some Muratec fax machines. The CCD reads fluorescent light bouncing off a document. The CIS uses a flat bar of light-emitting diodes (LEDs).

Command queue The list your machine keeps of all its pending commands.

Command number The number your machine gives to each job it is programmed to complete. You must know the command number in order to cancel or change any of the machine's jobs that it stores.

Compatibility The term *compatible* describes the ability of separate things to function together. Your Muratec fax machine features ITU-T Group 3 compatibility, the modern standard for worldwide communication.

Confidential transmission See *SecureMail*.

Confirmation report See *RCR* and *TCR*.

Continuous polling See *Polling*.

Copy mode Allows your fax machine to be used as a convenience copier.

Cover page (automatic) A small, user-created message; can be the first page of every transmission.

Database polling See *Polling*.

Data compression Used in digital fax machines to speed transmission. See also *Digital fax*, *MH* and *MSE, SMSE*.

Default The setting your machine will always refer to if no other action has been programmed. For example, you can set the default for this machine to send a fax by using its memory. If you set this action as the default, that's how your machine will always send a fax, until you tell it to do differently.

Delayed command Transmission or polling operation set by the user to occur later, automatically, at a predetermined time. Great for reducing costs by making fax calls during times when telephone costs are lowest, such as late at night or on weekends.

Digital Using the binary system (which uses a combination of *0s* or *1s*) to describe everything, so that *0* means *off* and *1* means *on*; digital fax machines convert the graphic image of your document into a series of zeros and ones by using the binary system of transmission to encode black and white occurrences. This increases transmission speed by passing over white spaces. See also *White-line skip*.

Digital fax Unlike analog systems that scan every portion of a document, digital fax machines survey a document's overall picture content. Digital fax machines scan a line and convert the information into a binary code of zeros and ones. The fax machine takes this information and compresses it, providing high transmission speeds. Many Muratec units offer proprietary methods for faster transmissions between Muratec-manufactured units (see also *MSE, SMSE*).

DIP switches Dual in-line package switch; a two-position on/off switch. Many Muratec fax machines include DIP switches to control optional settings or features.

Document feeder The adjustable slot into which users place documents for faxing or copying.

Effective printing width The widest image that can be printed on a fax.

Effective scan width The maximum width the scanner in a fax can scan during transmission.

F-Code A fax-industry standard created by the ITU-T for sub-addressing/password-based communications. Because F-Code is an industry standard, Muratec fax machines as well as all ITU-T equipped fax machines from other manufacturers can communicate with each other using sub-addressing.

Facsimile (or fax) A form of communication involving the scanning and decoding of a document into electrical signals and transmitting of the document, over telephone lines to another device. This device then reconstructs the signals to produce an exact duplicate of the document. Also, a machine that performs such communication.

Fallback Group 3 fax machines operate at the highest transmission speed possible on a given telephone line. Muratec systems offer automatic fallback; if line quality drops during transmission, the fax machine will reduce speed to the fastest possible level.

File number A number the machine gives to each document it stores for a batch, F-Code or polling operation.

Fine resolution 203H × 196V lpi. Also shown as *G3F* (Group 3 fine) on some fax units.

Grayscale Not a level of resolution, but a method of scanning and transmitting halftone images. Fax machines with grayscale abilities interpret photographs in levels of gray between white and black. The transmitting fax machine must have grayscale ability to send a photographic image accurately, but the receiving machine does not need it to print the image.

Group 3 Refers to fax machines that use digital encoding. These units transmit one page in less than one minute and produce resolution of 203 × 98, 203 × 196, or 406 × 392 lpi.

Halftone See *Grayscale*.

Handshaking An exchange of data between telecommunications and/or computer equipment that introduces two systems to each other. For example, faxes use a handshaking protocol to identify the ITU-T group of each unit and to begin fax communication.

Hub See *Relay broadcasting*.

Hz (or Hertz) A measure of frequency equal to one cycle per second. Used in the specifications for a fax machine, it identifies the AC power the unit requires.

ITU-T International Telecommunications Union Telecommunications Sector. (Formerly known as *CCITT*, for *Consultative Committee for International Telegraph and Telephone*.) A telecommunications forum for member countries of the United Nations whose Study Group XIV established the primary groups for fax equipment, covering communication protocol and transmission. Muratec Group 3 fax machines offer the fastest transmissions allowed by the ITU-T when communicating with other Group 3 units.

ITU-T Test Document 1 Also called the *Slerexe (slehr-rehks) letter*; An ITU-T standard document with a known black density which fax makers often use to test transmission speeds of their fax machines. Published transmission speeds are also based on this document.

ITU-T v.29 and v.27 ter. A standard set of communication procedures allowing fax machines to talk to all other units adhering to those standards.

JBIG Joint Bi-level Image experts Group, the new ITU-T standard image data compression method. As JBIG compresses the data more efficiently than MMR, it is especially effective when transmitting halftone (grayscale) image document. (Of course, the compression ratio may vary with the image data.)

Laser printing A plain-paper printing system. Toner is attached to a charged drum and an image is transferred onto plain paper through electrical currents, then fused with heat and pressure to produce a dry, permanent printout.

LCD Liquid crystal display. Used on some Muratec units for status displays.

Leased line See *Private line*.

Load number A number assigned to telecommunications equipment used in Canada; designed to help prevent overloading on a telephone circuit. See also *Ringer equivalence number*.

Location ID See *Station ID*.

lpi Lines per inch. The way fax image resolution is measured. (For example, see *Normal resolution*.)

Memory Internal document storage. In Muratec fax machines, random access memory in the form of computer chips is used to store and hold documents for transmission and to hold some documents that have been received.

Memory overflow A message that appears on the machine's LCD when the current operation requires more of the machine's electronic memory than what is available.

MH Modified Huffman, the standard ITU-T Group 3 data compression method. A one-dimensional coding scheme that compresses data in a horizontal direction only. A feature of all Muratec fax machines, MH assures transmissions faster than one page per minute when communicating with other Group 3 units, regardless of manufacturer. See also *MR, MMR, MSE, SMSE*.

Military format See *24-hour format*.

Modem Modulator-demodulator. A device that converts digital data, like information from a fax machine, into an analog signal for transmission over ordinary telephone lines. A modem is included in a fax machine and allows it to be connected directly to a PSTN telephone line.

MR Modified Read, an ITU-T Group 3 standard data compression method. A two-dimensional coding scheme that compresses data in both horizontal and vertical directions and allows for faster transmission when communicating with other Group 3 units, regardless of manufacturer. See also *MH, MMR, MSE, SMSE*.

MMR Modified Modified Read, an ITU-T Group 3 standard data compression method. A two-dimensional coding scheme that compresses data in both horizontal and vertical directions and allows for faster transmission when communicating with other Group 3 units, regardless of manufacturer. See also *MH, MR, MSE, SMSE*.

Monitor A speaker in most Muratec fax machines which allows the user to hear the dialing process. This is not a speakerphone, because it has no microphone for speaking to the person being called. For regular two-way voice communication, users must use the optional handset. See also *On-hook dialing*.

MSE, SMSE Muratec's proprietary data compression methods, allowing a Muratec-manufactured fax machine to transmit more quickly when communicating with another Muratec-manufactured unit. MSE and SMSE are features on many Muratec fax machines. See also *MH, MR, MMR*.

Normal resolution Shown as *norm*; 203H × 98V lpi. The default resolution mode for all Muratec fax machines.

One-touch dialing Allows the fax user to store frequently used fax numbers for dialing with the touch of one key. See also *Autodialing* and *Speed-dialing*.

On-hook dialing Dialing numbers by using the keypad on the fax unit without lifting a handset. On most Muratec fax models, the user can do this either silently or by using the monitor. See also *Monitor*.

Original document size The largest (or smallest) document that can be fed safely through a fax machine.

Override To change existing settings.

Paper sizes All are width × length:

Letter-sized = 8.5" × 11.0" (216 × 279 mm) Legal-sized = 8.5" × 14.0" (216 × 356 mm)

A5 = 5.8" × 8.3" (148 × 210 mm)

B5 = 7.2" × 10.1" (182 × 257 mm)

A4 = 8.3" × 11.7" (210 × 297 mm)

B4 = 10.1" × 14.3" (257 × 364 mm)

A3 = 11.7" × 16.5" (297 × 420 mm)

Passcode A four-digit code-number. On your fax machine, the protection passcode lets the user limit access to fax operations, as well as certain settings and even documents readied for polling (in the case of polling, only calling machines whose users enter the proper passcode will be able to poll the document.)

PBX (or PABX) Private branch exchange; privately-owned telephone equipment serving a particular building, business or area. Many PBX systems use digital transmission lines which, unlike more common PSTN lines, are not compatible with fax machine use. The user should not connect a fax unit to a PBX without first checking with the system manufacturer or service representative.

PCL Page Control Language. An industry standard for printer control. Some Muratec fax machines include or offer PCL-compatible printing for Windows-based personal computers.

Platen A traditional copier-style top to a fax machine or digital copier. Some Muratec fax machines and multifunctional products include a platen top, allowing you to fax from books and other awkward sources.

Polling Automatic transmission to a calling remote fax, or reception of a document from a remote fax set for this operation. Polling is convenient whenever a central unit must receive information from one or several remote faxes. The caller bears all telephone charges and prevents several remote units from calling at the same time. See also *Secure polling*.

Private line (Or *leased line*.) A service offered by many telephone systems; provides an exclusive phone circuit between two geographic points. A Muratec fax does not require a private line. See also *PSTN*.

Proprietary Non-standard. In fax, refers to a fax feature which works only in communications between fax machines that are the same brand.

PSTN Public switched telephone network; the most common type of telephone lines and service in use, in contrast to private or leased lines. A Muratec fax provides fast, reliable data transmission over a PSTN line, and does not need a special or dedicated telephone line. See also *Private line*.

QuadAccess[®] Muratec's QuadAccess allows your Muratec fax machine to perform four or more tasks simultaneously without slowing.

RCR Receive confirmation report. An RCR is your assurance that the document you transmitted was received. The RCR prints after your transmission, identifying the receiving unit and recording the date, time, transmission mode, number of pages sent and the result. The RCR is an exclusive feature of Muratec fax machines and is available only when transmitting to other, compatible Muratec fax machines. See also *TCR*.

Receiver ID See *Station ID*.

Redialing The dialing again, either manually or automatically controlled, of the most recently dialed fax or phone number. Automatic redialing follows an unsuccessful dialing attempt and can be done manually or automatically.

Relay broadcasting Lets some Muratec fax machines store a document in internal memory, transmit the document to the memory of a remote hub fax and then instruct that unit to relay (re-transmit) the document to each fax in a call group in the hub unit. This feature speeds extremely high-volume fax communication and allows a single command to initiate document transmission to hundreds of preprogrammed fax locations. It also saves phone charges for the originating machine. Your machine can initiate a relay broadcast.

Remote fax machine The machine on the other end of a fax communication.

REN See *Ringer equivalence number*.

Resolution The resolution of documents transmitted or copied by fax machines is measured by the number of horizontal (H) and vertical (V) lines per inch (lpi) the unit can print. A Muratec unit may offer one or more of these resolution levels:

Normal	203H × 98V lpi
Fine	203H × 196V lpi
Superfine	203H × 392V lpi

Some Muratec units also offer grayscale transmission (see also *Grayscale*) for accurate reproduction of photographs and other shaded originals.

Ringer equivalence number Also called *REN*. A number assigned to telecommunications equipment used in the United States; designed to prevent overloading on a telephone circuit. See also *Load number*.

Scanning width See *Effective scanning width*.

SecureMail Allows a Muratec fax user to send a document to or receive one into (usually something confidential) an electronic mail box. The transmission is protected at the receiving Muratec fax by an access code; the receiving fax prints the document only when an authorized user enters the code.

Secure polling Polling in which preset passcodes are checked between two machines before polling is allowed to take place.

Speed-dialing Allows the fax user to store frequently used fax numbers for dialing with the touch of three keys—an identifier key (either * or #) and then a three-digit code for each number. See also *Autodialing* and *One-touch dialing*.

Station ID (Also called *Location ID* or *Receiver ID*.) An autodialer feature which lets the fax user enter a descriptive name to correspond with the number in an autodialer entry. For example, rather than entering only 1-972-555-3465, the user can enter that number and a name, such as *Dallas Branch Office*. (Many Muratec models with this feature allow entry of both upper-case and lower-case letters, for greater ease of reading.)

Subaddressing An ITU-T standard allowing fax machines to specify special delivery characteristics of a transmission. For example, subaddressing allows fax machines from different manufacturers to send and receive messages into confidential memory mailboxes, or to retrieve specific files from polling memory.

Subscriber ID A fax machine's telephone number, as identified by a user setting. See *TTI*.

Super Group 3 An extension of Group 3 fax technology standards, allowing the use of high-speed v.34 bis modems for 33.6 Kbps transmission and high-speed protocols for rapid handshaking.

Superfine resolution 203H × 392V lpi. Your Muratec fax machine's superfine transmission mode is Group-3-compatible, not the more limited proprietary version.

TAD Telephone answering device, or answering machine. Records incoming voice messages for playback. You can connect a TAD to a Muratec fax machine and use the two on one phone line.

TCR Transmit confirmation report; this provides proof that your Muratec fax did send the document you set for transmission. Printed after transmission, the TCR also identifies the telephone number to which the fax sent the document, plus the actual time of transmission and how many pages the unit transmitted. See also *RCR*.

Thermal (paper) printing A thermal head heats chemically treated, thermally sensitive paper in patterns conforming to the image the machine has scanned, creating a printed image. Thermal paper's tendency to discolor and fade, in addition to its curliness and the usual difficulty in writing on it, have made this method considerably less popular than plain-paper fax printing—particularly as plain-paper fax machines have dropped sharply in price.

TriAccess Muratec's TriAccess allows a Muratec fax machine to perform three or more tasks simultaneously without slowing.

TTI Transmit terminal identifier. A user-programmable line of information sent automatically with every page a fax machine sends; it appears at the top of each page printed by the receiving unit.

Transmission speed How fast a fax machine is sending a fax document. This speed depends upon the modem speed of each unit, the resolution setting, the content of the document, the encoding technique and the condition of the phone line (clean, noisy, etc.) Any change in any one of these five conditions will affect the speed, sometimes significantly.

v.29 and v.27 ter A standard set of communication procedures allowing fax machines to talk to other units using those standards. Specifically, these standards cover fax transmission at 9600 bps or slower.

v.34 An international standard for fax modems—and other modems—with transmission speeds of up to 28.8 Kbps. The v.34 protocol is sometimes referred to as *v.Fast*, because it represented a significant increase in possible transmission speed compared to the transmission protocol it replaced.

v.34 bis A faster version of the v.34 standard, and sometimes referred to as *v.34 Plus* or *v.34 +*. The v.34 bis protocol allows transmission at up to 33.6 Kbps, and represents the current maximum standard transmission speed possible under ITU-T Group 3. (The term *bis* is French, and designates the second version of the protocol.)

White-line skip A technique used to speed up fax transmission by bypassing redundant areas, such as white space.

This page intentionally blank.

Appendix and index

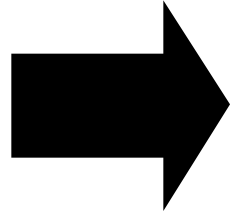

Specifications

General

Type:	Desktop plain paper facsimile
Compatibility:	MFX-1200: ITU-T Group 3 MFX-1600: ITU-T Group 3 and Super Group 3
Phone system:	Public Switched Telephone Network (PSTN) or equivalent
Dual access:	Multitasking
One-touch dial:	55 locations
Speed dial:	145 locations

Operating Environment

Environmental temperature:	10° C to 32° C (50 F to 89.6 F)
Relative humidity:	20 to 80% RH

Power requirement: Power: 120V AC 50/60 Hz.

	MFX-1200	MFX-1600
Power consumption: Sleep mode	: 16.0 W	19.0 W
Standby	: 17.3 W	21.2 W
Maximum	: 1360 W	1150 W

Communication

Coding method:	ITU-T-standard MMR, MR, MH, JBIG (MFX-1600 only) and Murata-proprietary MSE.
Modem speed:	MFX-1600: 33,600, 31,200, 28,800, 26,400, 24,000, 21,600, 19,200, 16,800, 14,400, 12,000, 9,600, 7,200, 4,800, 2,400 bps MFX-1200: 14,400, 12,000, 9,600, 7,200, 4,800, 2,400 bps

Error correction mode:	Yes
Memory capacity:	MFX-1200: 8MB (650 pages* approx.) Upgrade Option: plus 8MB (additional 680 pages* approx.) MFX-1600: 8MB (650 pages* approx.) Upgrade Option: plus 8MB (additional 680 pages* approx.) plus 24MB (additional 2040 pages* approx.)
Memory backup time:	(Total memory capacity: Backup time) 8MB : 72 hours 16MB: 36 hours 32MB: 18 hours (Must be charged for at least 24 hours to reach full charge)
Polling/Broadcasting:	230 locations / 230 locations
Transmission speed:	MFX-1200: Approx. 6 seconds per page.** MFX-1600: Approx. 2 seconds per page.**

Document input

Document set:	ADF :Face Up FBS :Face down
Original reference position:	ADF :Center FBS :Front right corner
Scanning resolution:	(horizontal in dots/inch × vertical in lines/inch):
	MFX-1200 MFX-1600
Transmission:	
Normal	203 98 203 98
Fine	203 196 203 196
Superfine	203 392 406 392***
Grayscale	203 196 203 196 (MemoryTx) 406 392*** (Real time Tx)
Copy:	
MFX-1200:	300 300 dpi
MFX-1600:	400 400 dpi

Appendix and index

Scanning method:	Flatbed CCD
Scanning width:	8.2 inch (Fax), 8.5 inch (Copy)
Document size :	(width height) ADF; single sheet: Maximum 8.5 inches 35.4 inches, Minimum 4.7 inches 3.9 inches ADF; two or more sheets : Maximum 8.5 inches 14.0 inches, Minimum 5.8 inches 4.1 inches FBS Maximum 8.5 inches 14.0 inches
ADF capacity:	50 sheets
Document thickness:	30.2 104.7 g/m ² , 13-24 lb (Single sheet) 52.3 80 g/m ² , 13-20 lb (Two or more sheets)
Grayscale:	256-level

Printout

Printer resolution:	600 dpi
Warm-up time:	Less than 20 seconds at 68" F (20" C)
First copy time:	MFX-1200: 12 seconds (using Letter-sized paper in 1st paper cassette) MFX-1600: 10 seconds (using Letter-sized paper in 1st paper cassette)
Paper exit system:	Face up exit system
Printing method:	LED scanning, Electrophotographic dry powered image transfer to plain paper
Print speed:	MFX-1200: Up to 12 ppm (using Letter-sized paper in 1st paper cassette) MFX-1600: Up to 16 ppm (using Letter-sized paper in 1st paper cassette)
Receive reduction print:	Auto (Variable from 100% to 50% by 1% ratio) Fixed (100%, 97%, 91%, 81% or 75%)
Copy reduce and enlarge:	Variable from 50% to 200% by 1% ratio Fixed (200%, 129%, 100%, 78%, 64% or 50%)
Smoothing print:	Yes
Printing paper size:	Paper cassette; Letter, Legal, Half-letter Bypass tray; **** Letter, Legal, Half-letter, A4, A5, A6, F4, Executive, DL, CM10, Monarch, Postcard (3.9 5.8 inches)

Paper capacity:	Paper cassette; 500 sheets (60 90 g/m ² , 20 24 lb) Bypass tray; 50 sheets (60 90 g/m ² , 20 24 lb)
Receiving paper tray capacity:	300 sheets (60 90 g/m ² , 20 24 lb)

Miscellaneous

Weight:	Approx. 51.4 lb (23.3 Kg)
Dimensions :	Width 20.1 Depth 19.4 Height 14.8 (inches)
Drum cartridge life:	Approx. 16,000 pages*****
Toner cartridge life:	Approx. 8,000 pages*****

* Using the ITU-T Test Document 1 to a Muratec fax machine with normal resolution.

** Based on transmission of ITU-T Test Document 1 to a Muratec fax machine. Your transmission times will vary, but your fax machine always will provide the fastest transmission speeds possible under ITU-T guidelines and phone-line conditions.

*** In the case that the remote fax has the ability of 406 dpi × 392 lpi .

If not, the superfine resolution is 203 dpi × 392 lpi , and the grayscale resolution in real time transmission is 203 dpi × 196 lpi .

**** The A4, A5, F4, A6, Executive, DL, CM10, Monarch and Postcard can be used only for coping.

***** Based on 6% document coverage and letter-sized two-page interval printing.

Note: Specifications are subject to change without notice.

Regulatory information

United States of America

Federal Communications Commission (FCC) information

Ringer Equivalence Number (RENS): MFX-1200: AC REN, 0.4B; DC REN, 0.3. MFX-1600: AC REN, 2.1B; DC REN, 0.3.

This facsimile machine has been tested and found to comply with the limits for a Class A digital device, pursuant to Part 15 of the FCC rules. These limits are designed to provide reasonable protection against such interference in a residential installation.

This equipment generates, uses and can radiate radio frequency energy and, if not installed and used in accordance with the instructions, may cause harmful interference to radio communications. However, there is no guarantee that interference will not occur in a particular installation.

If this equipment causes interference in radio or television reception (which can be determined by turning the equipment off and on), the user is encouraged to try to correct the interference by one or more of the following measures:

- Reorient or relocate the receiving antenna.

- Increase the separation between the equipment and receiver.

- Connect the equipment into an outlet on a circuit different from that to which the receiver is connected.

- Consult the dealer or an experienced radio/TV technician for help.

This equipment complies with Part 68 of the FCC rules. On the bottom of this equipment is a label that contains, among other information, the FCC registration number and REN for this equipment. If so requested, you must provide this information to the telephone company.

An FCC-compliant telephone cord and modular plug are provided with this equipment. This equipment is designed to be connected to the telephone network or premises wiring using a compatible modular jack which is Part-68-compliant.

Telephone company procedures

The goal of the telephone company is to provide you with the best service it can. In order to do this, it may occasionally have to make changes in its equipment, operations or procedures. If these changes might affect your service or the operation of your equipment, the telephone company will give you notice, in writing, to allow you to make any changes necessary to maintain uninterrupted service.

If you have any questions about your telephone line, such as how many pieces of equipment you can connect to it, the telephone company will provide this information upon request.

In certain circumstances, it may be necessary for the telephone company to request information from you about the equipment which you have connected to your telephone line. Upon request of the telephone company, provide the FCC registration number and the Ringer Equivalence Number (REN) of the equipment which is connected to your line. Both of these numbers are listed on the equipment label attached to your fax machine.

The sum of all RENS on your telephone line should be fewer than five (5) in order to assure proper service from the telephone company. Sometimes, a sum of five (5) may not be usable on a given telephone line.

Note: This equipment is hearing-aid-compatible (HAC).

Notice: The Telephone Consumer Protection Act of 1991 makes it unlawful for any person to use a computer or other electronic device to send any message via a telephone fax machine unless such message clearly contains, either in a margin at the top or bottom of each transmitted page or on the first page of the transmission, the date and time it was sent and an identification of the business or other identity, or other individual sending the message and the telephone number of the sending machine or such business, entity or individual. For instructions on programming this information (the TTI) into your fax machine, see pages 1.18 1.19.

Type of service

Your fax is designed for use on standard-device telephone lines. The fax connects to the telephone line with a standard line called the USOC RJ-11. Connection to telephone-company-provided coin service (central-office-implemented systems). Connection to party line service is subject to State tariffs.

If problems arise

If any of your telephone equipment is not operating properly, you should immediately remove it from your telephone line, as it may cause harm to the telephone network. If the telephone company notes a problem, they may temporarily stop service. When practical, they will notify you before this disconnection. If advance notice is not feasible, you will be notified as soon as possible. When you are notified, you will be given the opportunity to correct the problem and will be informed of your right to file a complaint with the FCC.

In the event repairs are ever needed on your fax machine, they should be done by Muratec America, Inc., or an authorized representative of Muratec America, Inc. For information, contact the Muratec Customer Support Center at 800-347-3296 (from the U. S. only).

Canada

Industry Canada (IC) regulations

IC RINGER EQUIVALENCE NUMBER (REN): MFX-1200: 0.3, MFX-1600: 0.7.

This digital apparatus does not exceed the Class A limits for radio noise emissions from digital apparatus as set out in the interference-causing equipment standard entitled Digital Apparatus, ICES-003 of the Department of Communications.

Cet appareil numérique respecte les limites de bruits radioélectriques applicables aux appareils numériques de Classe A prescrites dans la norme sur le matériel brouilleur: Appareils Numériques, NMB-003 édictée par le Ministre des Communications.

Notice: The Canadian Department of Communications label identifies certified equipment. This certification means the equipment meets certain telecommunications network protective, operational and safety requirements. The Department does not guarantee the equipment will operate to the user's satisfaction.

Before installing this equipment, users should ensure that it is permissible to be connected to the facilities of the local telecommunications company. The equipment must also be installed using an acceptable method of connection. Sometimes, the company's inside wiring associated with a single-line individual service may be extended with a certified connector assembly (telephone extension cord). The customer should be aware that compliance with these conditions may not prevent degradation of service in some situations.

Repairs to certified equipment should be made by an authorized Canadian maintenance facility designated by the supplier. Any equipment malfunction, or repairs or alterations made by the user to this equipment, may give the telecommunications company cause to request the user to disconnect the equipment.

Users should ensure for their own protection that the electrical ground connections of the power utility, telephone lines and internal metallic water pipe system, if present, are connected. This precaution may be particularly important in rural areas.

Caution: Users should not attempt to make such connections themselves, but should contact the appropriate electric inspection authority or electrician.

The Ringer Equivalence Number (REN) assigned to each terminal device provides an indication of the maximum number of terminals allowed to be connected to a telephone interface. The termination on an interface may consist of any combination of devices subject only to the requirement that the sum of the RENS of all the devices does not exceed 5. The IC REN for your equipment is 0.3 (MFX-1200), 0.7 (MFX-1600).

Limited warranty

This warranty is made by Muratec America, Inc. (hereafter referred to as Muratec). This warranty is valid only on Muratec products purchased and used in the United States of America. This warranty applies to the product only while owned and used by the original purchaser (Customer). If ownership of the product is transferred, this warranty terminates. This warranty does not apply to any product in use for rental purposes.

This Muratec product is warranted against defects in material and workmanship for ninety (90) days commencing the date of original Customer purchase. If the product is defective in material and/or workmanship (normal wear and tear excepted) during the warranty period, Muratec or its authorized representative will, during Muratec's established service availability hours, make necessary adjustments and repairs, including, at Muratec's option, installation of replacement parts. Muratec's service availability hours are 8:30 AM to 5:00 PM (Central time) Monday through Friday, excluding Muratec-recognized holidays. Muratec will complete the necessary adjustments and repairs within a reasonable time period, as dictated by the nature of the problem and by Muratec's service schedule. Replacement parts may have been used and/or reconditioned. Parts that have been replaced will remain the property of Muratec. This warranty is subject to the OBLIGATIONS and EXCLUSIONS set forth.

Obligations

1. This warranty will be honored only on presentation of the original dated authorized Muratec bill of sale or Muratec dealer bill of sale or sales slip to an authorized Muratec service representative or service center. For the name of your authorized service center, contact Muratec (from the United States, call 1-972-364-3350; from Canada, check your in-box materials for the number to call).
2. During the warranty period, the Customer must notify Muratec by telephone of any defective product material and/or workmanship.
3. Transportation (including prepayment of freight and insurance charges) of the product to and from an authorized service center, designated by Muratec, is the responsibility of the Customer.
4. If Muratec provides maintenance or responds to a call which is outside the scope of this warranty, such maintenance shall be billed to the Customer at Muratec's then-current rates for maintenance and parts and shall be due and payable in full upon receipt of invoice.

Exclusions

1. This warranty shall not cover a product with missing or altered original identification marks.
2. This warranty applies only to products that the purchaser has properly installed, adjusted and operated in accordance with the instructions set forth in or provided with product literature. This warranty does not apply to any product which has been subjected to tampering, alteration, misuse, abuse, neglect, improper installation or transportation damage. Nor does it apply to costs for any service requested for demonstration or to confirm proper operation of this product.
3. The warranty shall not apply to adjustments, repairs or replacements necessitated by any cause beyond the control of Muratec (whether foreseeable or not) including, but not limited to, any malfunction, defects or failure caused by or resulting from any of the following: improper unpacking or installation, unauthorized service or parts, or improper maintenance or cleaning, modification or repair by the Customer, accident (including, without limitation, unavoidable accidents), fire, flood or other Acts of God, improper telephone or electrical power or surges thereof, interconnection with or use of non-compatible equipment or supplies (including paper), or placement of the product in an area which does not conform to Muratec space, electrical and/or environmental requirements.
4. Muratec will not be required to make adjustments, repairs or replacements if the product is installed or used at a location deemed by Muratec to be hazardous to health or safety, or if Muratec is not provided with free and reasonable access to the product and a telephone during service availability hours, or if the product location is not accessible by an authorized Muratec service vehicle.

EXCEPT AS EXPRESSLY SET FORTH ABOVE, AND EXCEPT TO THE EXTENT PROHIBITED BY APPLICABLE LAW, MURATEC MAKES NO OTHER WARRANTIES, EXPRESS OR IMPLIED (INCLUDING, BUT NOT LIMITED TO, ANY IMPLIED WARRANTIES OF MERCHANTABILITY OR FITNESS FOR A PARTICULAR PURPOSE, AND ANY WARRANTY ARISING FROM COURSE OF DEALING OR USAGE OF TRADE), AND MURATEC EXPRESSLY DISCLAIMS ALL WARRANTIES NOT STATED HEREIN. IN THE EVENT THE PRODUCT IS NOT FREE FROM DEFECTS AS WARRANTED ABOVE, THE CUSTOMER'S SOLE REMEDY SHALL BE REPAIR OR REPLACEMENT AS PROVIDED ABOVE. UNDER NO CIRCUMSTANCES SHALL MURATEC BE LIABLE TO THE CUSTOMER, OR TO ANY USER, FOR ANY DAMAGES, INCLUDING ANY INCIDENTAL OR CONSEQUENTIAL DAMAGES, EXPENSES, LOST PROFITS, LOST SAVINGS OR ANY OTHER DAMAGES ARISING OUT OF THE USE OR INABILITY TO USE THE MURATEC PRODUCT, EVEN IF MURATEC OR ITS REPRESENTATIVES HAVE BEEN ADVISED OF THE POSSIBILITY OF SUCH DAMAGES.

Some States do not allow the exclusion or limitation of incidental or consequential damages, and some States do not allow limitations on how long an implied warranty lasts, so the above limitations or exclusions may not apply to you. This warranty gives you specific legal rights, and you may also have other rights which vary from State to State.

Index

- A**
- AC power cord 1.1
 - AC power switch 1.7
 - Activity journal 3.21
 - ADF (Automatic Document Feeder) 2.1
 - Advanced functions 1.3
 - ALARM light 1.3
 - Autodialer 3.1
 - call group 3.8
 - dialing characters 3.1
 - one-touch dialing 3.2
 - speed-dial 3.5
- B**
- Batch transmission 3.12
 - creating or modifying 3.12
 - erasing a document 3.14
 - erasing an empty batch box 3.14
 - printing a document stored in a batch box 3.13
 - printing a list of batch boxes 3.13
 - printing a list of stored batch documents 3.13
 - storing a document 3.13
 - Block Junk Fax 3.54
 - Block numbers list 3.55
 - Broadcasting 2.8, 3.10
 - reviewing or canceling parts of a broadcast 2.8
- C**
- Call group dialing 3.8
 - Call request 3.25
 - Canceling commands 2.8
 - printing a delayed command list 2.9
 - printing a stored document 2.9
 - review Commands 2.8
 - Caring for your fax machine 5.12
 - Corrective cleaning 5.12
 - Changing the default settings
 - for copying
 - Auto reset time 4.7
 - Primary contrast 4.6
 - Primary document type 4.6
 - Print margin 4.6
 - Combine (MFX-1600 only) 4.7
 - Copy auto 4.7
 - Negative/Positive 4.7
 - for dialing
 - Pause length 4.5
 - Redial settings 4.5
 - for operation
 - 2-bin tray 4.9
 - Primary standby mode 4.9
 - Sleep mode 4.9
 - Silent mode 4.8
 - for reception
 - Half-page reception 4.3
 - Image rotation (MFX-1600 only) 4.4
 - Print reduction rate 4.3
 - Reduction margin 4.3
 - Number of rings 4.4
 - for transmission
 - ECM mode 4.1
 - Memory transmission 4.2
 - Primary contrast mode 4.1
 - Primary resolution mode 4.1
 - Quick memory transmission 4.2
 - TTI transmit 4.2
 - Print your settings
 - Copy settings list 4.10
 - Fax settings list 4.10
 - Machine settings list 4.10
 - COMM. light 1.3
 - Communication problem See Troubleshooting
 - Control Panel 1.3
 - Copies 2.12
 - Basic procedure 2.12
 - Combine 2.17
 - Document type 2.15
 - Enlarge 2.13
 - Image contrast 2.16
 - Multiple copies 2.13
 - Copy Protection 2.18
 - Reduce 2.13
 - Reversing black and white areas 2.16
 - Single copy 2.12
 - Ultra copy mode 2.17

Appendix and index

Using the bypass tray	2.14
COPY light	1.3
Copy setting list	4.10
Auto reset time	4.7
Combine	2.17, 4.7
Contrast	4.6
Copy auto	4.7
Copy protect	2.18
Document type	4.6
Margin	4.6
Nega/Posi	2.16
Negative/Positive	4.7
Sort copy	2.16
Ultra copy mode	2.17, 4.8
Cover page	3.23

D

Delayed command	2.8
Delayed transmission	3.11
Department code	3.56
Dialing characters	3.1
Dialing options	1.3
Document tray	1.1
DRD (distinctive ring detection)	3.24
Drum cartridge	1.1, 1.6
Dual access	See QuadAccess

E

EasyDial directory dialing	3.9
EasyStart	See Initial settings
Error messages	5.5
Errors	5.9
Extension paper tray	1.1

F

Fax & Copy	3.21
FAX light	1.3
Fax setting list	4.10
Block Junk Fax	3.54
Contrast	4.1
Cover page	3.23
Department code	3.56
Department code protection	3.57
Dialing pause	4.5
DRD	3.24
ECM	4.1
Half-page reception	4.3
Journal auto print	3.21
Journal line up	3.22

Memory transmission	4.2
Number of rings	4.4
Passcode	3.15
Phone type	1.19
PIN mask feature	3.52
Quick memory transmission	4.2
Reception modes	2.10
Redial	4.5
Reduction margin	4.3
Report type	3.22
Resolution	4.1
Rx reduction rate	4.3
Security reception	3.50
TTI transmission	4.2
Faxes	2.1
Receiving	2.10
Answering calls manually	2.10
Reception modes	2.10
Sending	2.1
Canceling commands	2.8
Contrast	2.2
Dialing pause	2.2
from Memory	2.3
How to set the document	2.1
In real time	2.3
Resolution, grayscale	2.2
using monitor/call key or a handset	2.6
using the ADF	2.4
using the FBS glass	2.5
F-Code boxes	3.26
Bulletin box	3.26, 3.30
Auto Print	3.28
Erase Tx Doc	3.29
Overwrite Doc	3.28
Rx Protect	3.28
Creating or modifying	3.26
Erasing an empty F-Code box	3.33
F-Code polling	3.35
F-Code transmission	3.34
Printing a list of documents stored in your F-Code boxes	3.30
Printing a list of F-Code boxes	3.30
Relay box	3.27, 3.33
Auto Print	3.29
Select TTI	3.29
Security box	3.26, 3.32
Document hold time setting	3.29
Function table	1.14

I	
Initial settings	1.18
J	
Jammed paper, removing	5.1
L	
Location ID	3.1
M	
Machine setting list	4.10
2-bin	4.9
Language	1.18
Paper size of the 1st cassette	1.9
Paper size of the 2nd Cassette	1.9
Paper size of the Bypass Tray	1.10
Primary mode	4.9
Service mode	1.14
Silent mode	4.8
Alarm & Key Volume	4.8
Alarm Silent	4.8
Key Buzzer Silent	4.8
Ringer Silent	4.8
Sleep mode	4.9
Soft Keys	3.17
Macro Keys	1.4
Macros	3.18
Erasing	3.20
Printing a list of your Macro keys	3.20
Programming	3.18
MEMORY RECEIVE light	1.3
Memory transmission	2.3
Mirror carriage locking plate	1.5
O	
One-touch keys	3.2
Entering or changing	3.2
Erasing	3.3
One-touch fax dialing	3.4
One-touch phone dialing	3.4
Printing a list of one-touch numbers	3.3
One-touch labels	1.1
Operating tips	1.11
Out-of-paper reception	2.11
P	
Passcode protection	3.50
Paper	1.8
Acceptable paper size	1.8
Paper size setting	1.9
Paper size stickers	1.1
Pause character, entering	2.2
PIN masking	3.52
Passcode	3.50
Polling	3.15
Being polled	3.15
Limiting polling access	3.15
Regular polling	3.15
Print quality problems	5.3
Printer status lights	1.4
Printing your settings	4.10
Copy settings list	4.10
Fax settings list	4.10
Machine settings list	4.10
Programmable one-touch keys	3.36
Q	
QuadAccess	3.26
Quick memory transmission	2.3
R	
Real time transmission	2.3
Receiving faxes	2.10
Redialing	2.7
Regulatory information	AI.3
Reports, confirmation	3.22
RCR	3.22
TCR	3.22
S	
Security features	3.50
Block Junk Fax	3.54
Department codes	3.56
Masking the PIN	3.52
Passcode	3.50
Security reception	3.50
Security reception	3.50
Passcode	3.50
Sending faxes	2.1
Setting up	1.5
Adjust the monitor speaker's volume	1.8
Attach the paper-handling parts	1.7
Initial settings	1.18

Appendix and index

Installing the printing supplies	1.6
Pick an installation spot	1.5
Turning off the transport mode	1.8
Unlocking the mirror carriage	1.5
Soft Key labels	1.1
Soft Keys	1.3, 3.17
Setting	3.17
Special features	3.17
Activity journal	3.21
Call request	3.25
Cover page	3.23
Distinctive ring detection (DRD)	3.24
Fax & Copy	3.21
F-Code Boxes	3.26
Macro keys	3.18
Programmable one-touch keys	3.36
Reports	3.22
Soft keys	3.17
Specifications	AI.1-AI.2
Speed-dial numbers	3.5
Entering or changing	3.5
Erasing	3.6
Fax dialing via speed-dial	3.7
Phoning via speed-dial	3.7
Printing a list of speed-dial numbers	3.6
Subscriber ID (your fax's phone number)	1.19

T

Telephone line cord	1.1
Toner cartridge	1.1, 1.6
Troubleshooting	5.5
TTI (Transmit Terminal Identifier)	1.18

U

Using the optional handset	2.19
----------------------------	------

W

Warranty, limited	AI.4
-------------------	------