

brother®

USER'S GUIDE

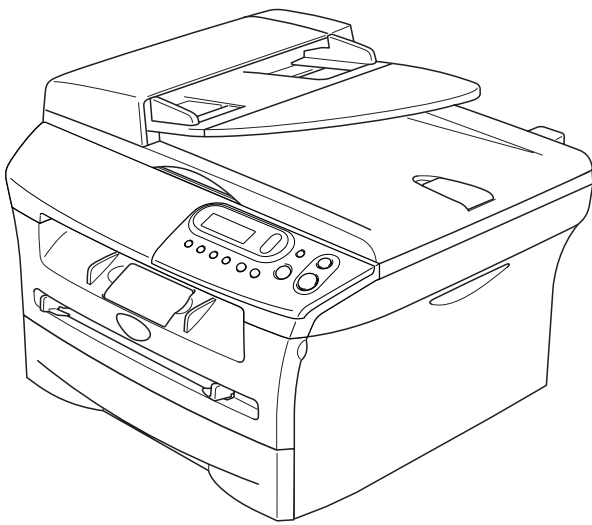

DCP-7010L
DCP-7025

CE

If you need to call Customer Service

Please complete the following information for future reference:

Model Number: DCP-7010L and DCP-7025
(Circle your model number)

Serial Number:* _____

Date of Purchase: _____

Place of Purchase: _____

* The serial number can be displayed on the LCD screen (Menu, 3, 1 (for DCP-7010L) and Menu 4, 1 (for DCP-7025)). Retain your sales receipt as a permanent record of your purchase, in the event of theft, fire or warranty service.

Register your product on-line at

<http://www.brother.com/registration>

By registering your product with Brother, you will be recorded as the original owner of the product. Your registration with Brother:

- may serve as confirmation of the purchase date of your product should you lose your receipt; and,
- may support an insurance claim by you in the event of product loss covered by insurance.

The most convenient and efficient way to register your new product is on-line at <http://www.brother.com/registration>

Compilation and Publication Notice

Under the supervision of Brother Industries Ltd., this manual has been compiled and published, covering the latest product descriptions and specifications.

The contents of this manual and the specifications of this product are subject to change without notice.

Brother reserves the right to make changes without notice in the specifications and materials contained herein and shall not be responsible for any damages (including consequential) caused by reliance on the materials presented, including but not limited to typographical and other errors relating to the publication.



EC Declaration of Conformity

Manufacturer

Brother Industries Ltd.
15-1, Naeshiro-cho, Mizuho-ku, Nagoya 467-8561 Japan

Plant

Brother Technology (ShenZhen) Ltd.,
NO6 Gold Garden Ind. Nanling Buji, Longgang, Shenzhen, China

Herewith declare that:

Products description : Laser Printer
Product Name : DCP-7010L
Model Number : DCP-7010

are in conformity with provisions of the Directives applied : Low Voltage Directive 73/23/EEC (as amended by 93/68/EEC) and the Electromagnetic Compatibility Directive 89/336/EEC (as amended by 91/263/EEC and 92/31/EEC and 93/68/EEC).

Harmonized standards applied :

Safety EN60950-1:2001

EMC EN55022:1998 + A1:2000 + A2:2003 Class B
EN55024:1998 + A1:2001 + A2:2003
EN61000-3-2:2000
EN61000-3-3:1995 + A1:2001

Year in which CE marking was first affixed : 2007

Issued by : Brother Industries, Ltd.

Date : 10th January, 2007

Place : Nagoya, Japan

Signature :

Junji Shiota
General Manager
Quality Management Dept.
Printing & Solutions Company

Safety precautions

We use the following icons throughout this User's Guide.



Warnings tell you what to do to prevent possible personal injury.



Electrical Hazard icons alert you to a possible electrical shock.



Hot Surface icons warn you not to touch machine parts that are hot.



Cautions specify procedures you must follow or avoid to prevent possible damage to the machine or other objects.



Improper Setup icons alert you to devices and operations that are not compatible with the machine.



Notes tell you how you should respond to a situation that may arise or give tips about how the current operation works with other features.

To use the machine safely

Please keep these instructions for later reference and read them before attempting any maintenance.



WARNING



There are high voltage electrodes inside the machine. Before you clean the inside of the machine, make sure you have unplugged the power cord from the electrical socket.

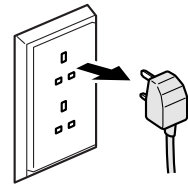

Do not handle the plug with wet hands. Doing this might cause an electrical shock.

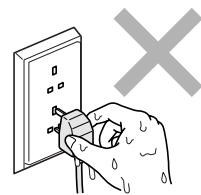

After you use the machine, some internal parts are extremely HOT! To prevent injuries, be careful not to put your fingers in the areas shown in the illustration.

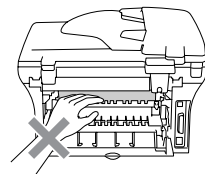
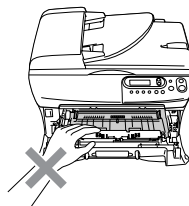

! WARNING



The fuser unit is marked with a caution label. Please do not remove or damage the label.

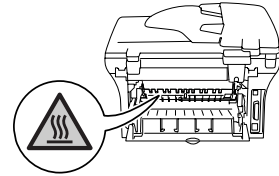

To prevent injuries, be careful not to put your hands on the edge of the machine under the document cover or scanner cover.

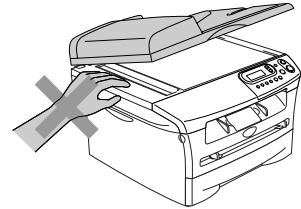
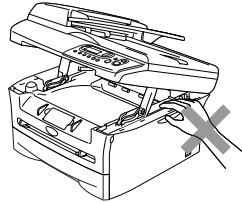

To prevent injuries, be careful not to put your fingers in the area shaded in the illustration.

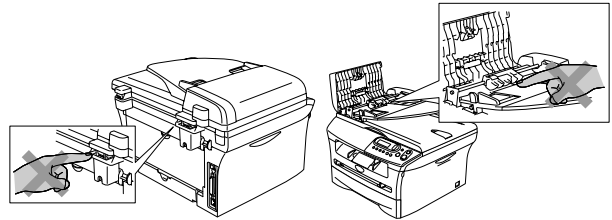

When you move the machine, grasp the side hand holds that are under the scanner. **DO NOT** carry the machine by holding it at the bottom.

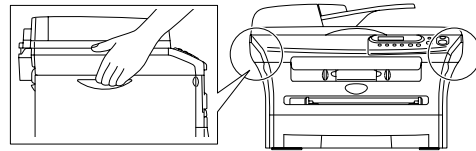

Do not use a vacuum cleaner to clean up scattered toner. Doing this might cause the toner dust to ignite inside the vacuum cleaner, potentially starting a fire. Please carefully clean the toner dust with a dry, lint-free cloth and dispose of it according to local regulations.



This product must be installed near an electrical socket that is easily accessible. In case of an emergency, you must disconnect the power cord from the electrical socket to shut off the power completely.



Do **NOT** use flammable substances or any type of spray to clean the inside or outside of the machine. Doing this may cause a fire or electrical shock.

Table of Contents

1 Introduction

Using this Guide	1-1
Choosing a location	1-2
Control panel overview	1-3
Load document.....	1-4
Using the automatic document feeder (ADF) (DCP-7025 only)	1-4
Using the scanner glass	1-5
About paper	1-6
Recommended Paper.....	1-6
Choosing acceptable paper	1-6
How to load paper	1-8

2 Getting started

Initial Setup	2-1
Setting the Paper Type	2-1
Setting the Paper Size	2-1
Setting the Beeper Volume.....	2-2
Toner Save	2-2
Sleep Time	2-3
Setting the LCD Contrast.....	2-3
Printing the User Settings List	2-3

3 Making copies

Using the machine as a copier	3-1
Making a single copy	3-1
Making multiple copies	3-1
Stop copying.....	3-1
Using the Temporary Copy keys	3-2
Enlarging or reducing the image copied	3-2
Adjusting contrast	3-3
Changing the temporary copy settings	3-4
Changing the default copy settings.....	3-7
Quality	3-7
Adjusting contrast	3-8
Out of Memory message	3-8

4 Software Features 4-1

5 Important information

IEC 60825-1 Specification	5-1
Disconnect device	5-1
Radio interference (220-240V Model Only)	5-2
Important safety instructions.....	5-2
Trademarks	5-3

6 Troubleshooting and routine maintenance

Troubleshooting	6-1
Error messages	6-1
Document jams (DCP-7025 only)	6-3
Paper jams	6-4
If you are having difficulty with your machine	6-8
Improving the print quality	6-11
Cleaning the drum unit	6-12
How to change the LCD language	6-15
Packing and shipping the machine	6-15
Routine maintenance	6-16
Cleaning the outside of the machine	6-16
Cleaning the scanner glass	6-17
Cleaning the laser scanner window	6-18
Cleaning the corona wire	6-19
Replacing the toner cartridge (TN-2000)	6-20
How to replace the toner cartridge	6-20
Replacing the drum unit (DR-2000)	6-23
Machine Information	6-25
Checking the Serial Number	6-25
Checking the Page Counters	6-25
Checking the Drum Life	6-25

A Appendix

On-screen programming	A-1
Menu table	A-1
Menu Mode	A-1

S Specifications







Product description	S-1
General	S-1
Print media	S-2
Copy	S-3
Scanner	S-3
Printer	S-4
Interfaces	S-4
Computer requirements	S-5
Consumable items	S-5

I Index

I-1

Using this Guide

Throughout this Guide you will see special symbols alerting you to important warnings, notes and actions. Special fonts identify keys you should press, messages that appear on the LCD, and important points or related topics.

- Bold** Bold typeface identifies specific keys on the machine's control panel.
- Italics* Italicized typeface emphasizes an important point or refers you to a related topic.
- `Courier` Courier type face identifies the messages on the LCD of the machine.
-  Warnings tell you what to do to prevent possible personal injury.
-  Electrical Hazard icons alert you to a possible electrical shock.
-  Hot Surface icons warn you not to touch machine parts that are hot.
-  Cautions specify procedures you must follow or avoid to prevent possible damage to the machine or other objects.
-  Improper Setup icons alert you to devices and operations that are not compatible with the machine.
-  Notes tell you how you should respond to a situation that may arise or give tips about how the current operation works with other features.



Note

Illustrations in this User's Guide are based on DCP-7025.

Choosing a location

Place your machine on a flat, stable surface that is free of vibration and shocks, such as a desk. Put the machine near a standard, grounded electrical socket. Choose a location where the temperature remains between 10°C and 32.5°C.

! CAUTION

- Avoid placing your machine in a high-traffic area.
- Do not place your machine near heaters, air conditioners, water, chemicals, or refrigerators.
- Do not expose your machine to direct sunlight, excessive heat, moisture, or dust.
- Do not connect your machine to an electrical socket controlled by wall switches or automatic timers.
- Disruption of power can wipe out information in the machine's memory.
- Do not connect your machine to an electrical socket on the same circuit as large appliances or other equipment that might disrupt the power supply.
- Avoid interference sources, such as speakers or the base units of cordless phones.

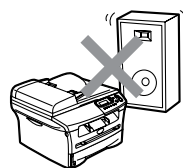
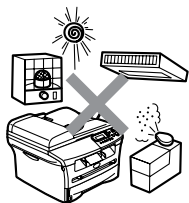

Control panel overview

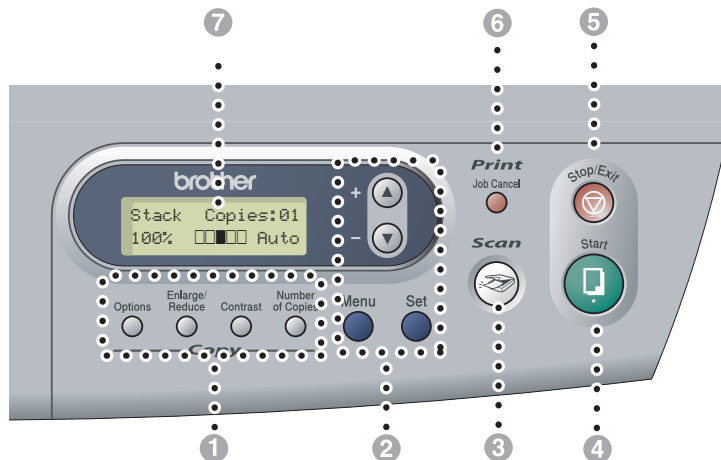

1 Copy keys

(Temporary settings):

Options

You can quickly and easily select temporary settings for copying.

Enlarge/Reduce

Lets you enlarge or reduce copies depending on the ratio you select.

Contrast

Lets you select the copy quality for your type of document.

Number of Copies

Use this key to make multiple copies.

2 Menu Mode:

Menu

Lets you access the Menu to program.

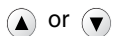

Press to scroll through the menus and options. Also you can use these keys to enter numbers.

Set

Lets you store your settings in the machine.

3 Scan

Lets you access Scan mode.

4 Start

Lets you start making copies or start scanning.

5 Stop/Exit

Stops an operation or exits from the menu.

6 Print key:

Job Cancel

You can cancel a print job and clear the print memory.

7 Liquid Crystal Display (LCD)

Displays messages on the screen to help you set up and use your machine.

Load document

You can make copies and scan from the ADF (automatic document feeder) and from the scanner glass.

Note

ADF is not available for DCP-7010L.

Using the automatic document feeder (ADF) (DCP-7025 only)

The ADF can hold up to 35 pages and feeds each sheet individually. Use standard (80 g/m²) paper and always fan the pages before putting them in the ADF.

Improper Setup

- **DO NOT** use paper that is curled, wrinkled, folded, ripped, stapled, paper-clipped, pasted or taped.
- **DO NOT** use cardboard, newspaper or fabric.
- Make sure documents written with ink are completely dry.
- Documents to be scanned must be from 147.3 to 215.9 mm wide and 147.3 to 356 mm long.

- 1 Fan the pages well. Make sure you put the documents **face up, top edge first** in the ADF until you feel them touch the feed roller.
- 2 Adjust the paper guides to fit the width of your documents.

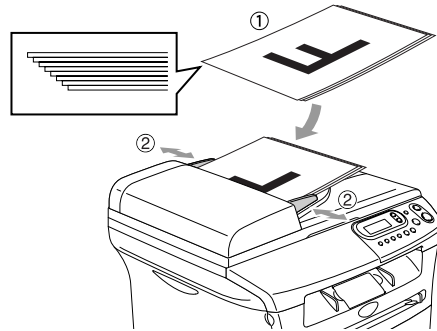

- 3 Unfold the ADF document output support flap.

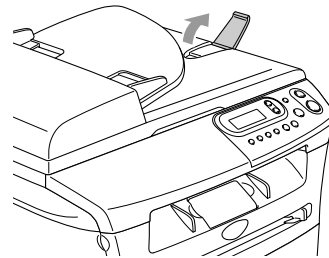

CAUTION

- **DO NOT** pull on the document while it is feeding.
- Thick documents left on the scanner glass may cause the ADF to jam.

Using the scanner glass

You can use the scanner glass to copy or scan pages of a book or one page at a time. Documents can be up to 215.9 mm wide and 297 mm long.



Note

DCP-7025 only:

To use the scanner glass, the ADF must be empty.

- 1 Lift the document cover.
- 2 Using the document guidelines on the left, centre the document face down on the scanner glass.

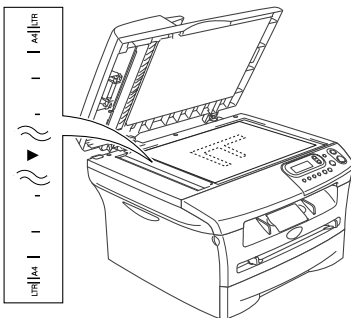

Place documents face down on the scanner glass.

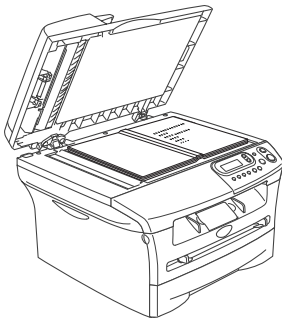

- 3 Close the document cover.

! CAUTION

If the document is a book or is thick, do not slam the cover or press on it.

About paper

Recommended Paper

To get the best print quality, we suggest using the following paper.

Paper Type	Item
Plain paper	Xerox Premier 80 g/m ²
	Xerox Business 80 g/m ²
	M-real DATACOPY 80 g/m ²
	IGEPA X-Press 80 g/m ²
Recycled paper	Xerox Recycled Supreme
Transparency	3M CG 3300
Labels	Avery laser label L7163

- Use paper that is made for plain-paper copying.
- Use paper that is 75 to 90 g/m².
- Use neutral paper. Do not use acidic or alkaline paper.
- Use long-grain paper.
- Use paper with a moisture content of approximately 5%.

Choosing acceptable paper

We recommend that you test paper (especially special sizes and types of paper) on the machine before purchasing large quantities.

For optimum printing, use a recommended type of paper, especially for plain paper and transparencies. For more information on paper specifications, call your nearest authorized sales representative or the place where you purchased your machine.

- Use labels or transparencies that are designed for use in laser printers.
- If you are using special paper and the machine has problems feeding from the paper tray, try again using the manual feed slot.
- You can use recycled paper in this machine.

! CAUTION

Do not use the following types of paper or envelopes, they may cause a paper jam and damage your machine.

Do not use:

- Inkjet paper;
- Coated paper, such as vinyl coated paper;
- Pre-primed or highly textured paper, or paper with an embossed letterhead;
- Label sheets that have had any labels removed;
- Paper that has been previously printed on;
- Paper that cannot be arranged uniformly when stacked;
- Paper that is made with a short grain;
- Damaged, curled, wrinkled, or irregularly shaped paper.

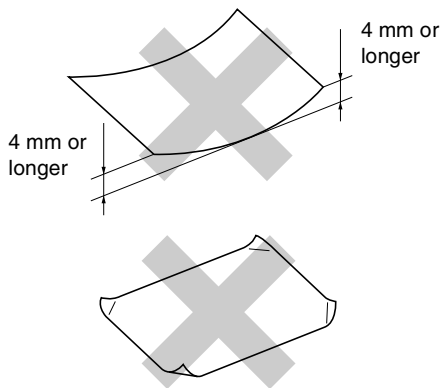

Do not use:

- Envelopes that have a baggy construction;
- Envelopes that are embossed (have raised writing on them);
- Envelopes that have clasps on them;
- Envelopes that are not sharply creased;
- Envelopes that are pre-printed on the inside.

Paper capacity of the paper trays

	Paper size	Paper types	No. of sheets
Paper tray	A4, Letter, Executive, A5, A6, B5 and B6	Plain paper, Recycled paper	up to 250 (80 g/m ²)
		Transparency	up to 10
Manual feed slot	Width: 69.9 - 215.9 mm Length: 116 - 406.4 mm	Plain paper, Recycled paper, Bond paper, Envelope, Label and Transparency	1

How to load paper

To load paper or other media in the paper tray

- 1 Pull the paper tray completely out of the machine.

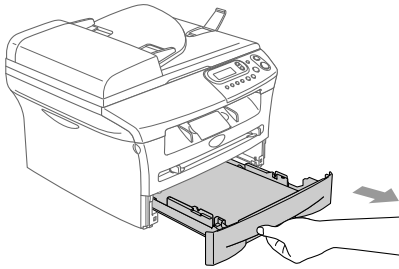

- 2 While pressing the paper guide release lever, slide the adjusters to fit the paper size. Check that the guides are firmly in the slots.

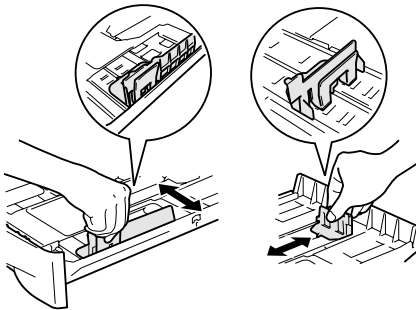

- 3 Fan the stack of paper well to avoid paper jams and mis-feeds.

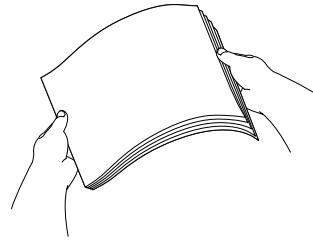

- 4 Put paper in the paper tray.

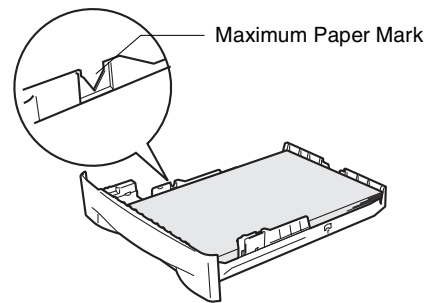

- 5 Put the paper tray firmly back in the machine and unfold the output paper tray support flap before you use the machine.

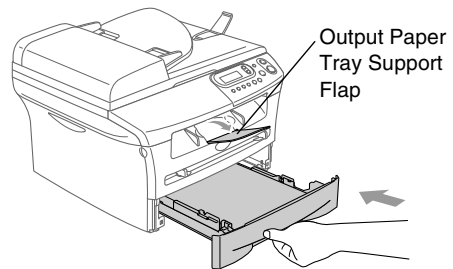

Note

When you put paper in the paper tray, please remember the following:

- Check that the paper is flat in the tray and below the maximum paper mark, and that the paper guides are touching the sides of the paper stack.
- The side to be printed on must be face down.

To load paper or other media in the manual feed slot

You can load envelopes and special print media one at a time into this slot. Use the manual feed slot to print or copy on labels, envelopes or thicker paper.

- 1 Slide the paper guides to fit the paper size.

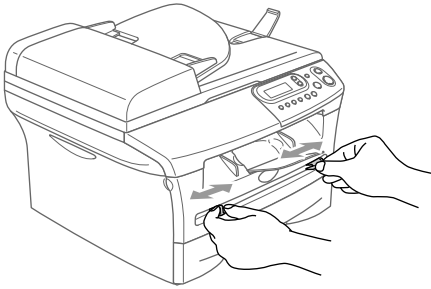

- 2 Using both hands put the one sheet of paper in the manual feed slot until you feel the front edge of the paper touch the paper feed roller. Let go of the paper when you feel the machine feed the paper in a short distance.

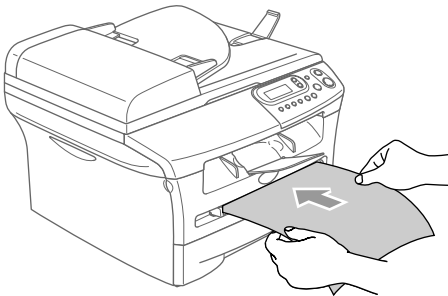

Note

When you put paper in the manual feed slot, please remember the following:

- The side to be printed on must be face up.
- Put the leading edge (top of the paper) in first and push it gently into the slot.
- Make sure that the paper is straight and in the proper position on the manual feed slot. If it is not, the paper may not be fed properly, resulting in a skewed printout or a paper jam.
- Do not put more than one sheet or envelope in the manual feed slot at a time, or you may cause the machine to jam.
- You can remove smaller sizes of printed paper from the output paper tray more easily if you lift the scanner cover, using both hands, as shown in the illustration.

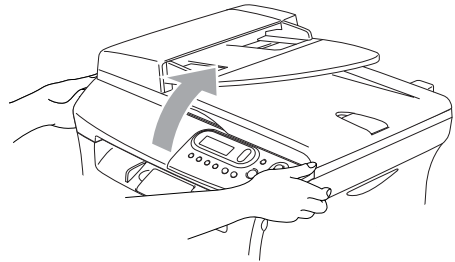

You can still use the machine when the scanner cover is raised. You can return the scanner cover to its home position by pushing it down with both hands.

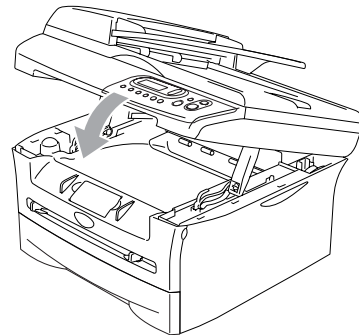

2



Getting started

Initial Setup

Setting the Paper Type



To get the best print quality, set the machine for the type of paper you are using.

- 1 Press **Menu** and  or  to select 1.General Setup.
Press **Set**.

- 2 Press  or  to select 1.Paper Type.

General Setup
1.Paper Type

Press **Set**.

- 3 Press  or  to select Plain, Thin, Thick, Thicker, Transparency or Recycled Paper.
Press **Set**.

- 4 Press **Stop/Exit**.

Note

- The machine ejects paper with printed surfaces face down onto the output paper tray in the front of the machine. When you use transparencies or labels, remove each sheet immediately to prevent smudging or paper jams.
 - You can select **Transparency** in Step 3 if Letter or A4 paper size has been selected.
-



Setting the Paper Size

You can use seven sizes of paper for printing copies: Letter, A4, A5, A6, B5, B6 and Executive. When you change the size of paper you load in the paper tray, you will need to change the setting for paper size at the same time so your machine can fit a reduced copy on the page.

Note



If you selected **Transparency** as the paper type, you will only be able to select Letter or A4 size paper in Step 3.

- 1 Press **Menu** and  or  to select 1.General Setup.
Press **Set**.

- 2 Press  or  to select 2.Paper Size.

General Setup
2.Paper Size

Press **Set**.

- 3 Press  or  to select Letter, A4, A5, A6, B5, B6 or Executive.
Press **Set**.

- 4 Press **Stop/Exit**.

Setting the Beeper Volume

You can change the beeper volume. The default setting is *Med.* When the beeper is on, the machine will beep when you press a key or make a mistake.

- 1 Press **Menu** and ▲ or ▼ to select 1. *General Setup*.
Press **Set**.
- 2 Press ▲ or ▼ to select 3. *Beeper*.

General Setup
 3. *Beeper*

 Press **Set**.
- 3 Press ▲ or ▼ to select *Low, Med, High* or *Off*.
Press **Set**.
- 4 Press **Stop/Exit**.

Toner Save

You can conserve toner using this feature. When you set *Toner Save* to *On*, print appears lighter. The default setting is *Off*.

- 1 Press **Menu** and ▲ or ▼ to select 1. *General Setup*.
Press **Set**.
- 2 Press ▲ or ▼ to select 4. *Ecology*.

General Setup
 4. *Ecology*

 Press **Set**.
- 3 Press ▲ or ▼ to select 1. *Toner Save*.
Press **Set**.
- 4 Press ▲ or ▼ to select *On* (or *Off*).
Press **Set**.
- 5 Press **Stop/Exit**.

Sleep Time

Setting the Sleep Time reduces power consumption by turning off the fuser inside the machine while it is idle. You can choose how long the machine is idle (from 00 to 99 minutes) before it goes into sleep mode. The timer is automatically reset when the machine receives PC data or makes a copy. The factory setting is 05 minutes. While the machine is in sleep mode you will see *Sleep* on the LCD. If you try to print or copy in sleep mode, there will be a short delay while the fuser warms up to its working temperature.

- 1 Press **Menu** and ▲ or ▼ to select 1.General Setup.
Press **Set**.
- 2 Press ▲ or ▼ to select 4.Ecology.

General Setup
4.Ecology

 Press **Set**.
- 3 Press ▲ or ▼ to select 2.Sleep Time.

Ecology
2.Sleep Time

 Press **Set**.
- 4 Use the ▲ or ▼ to enter the length of time the machine is idle before it goes into sleep mode (00 to 99).
Press **Set**.
- 5 Press **Stop/Exit**.



Note

If you want to turn off sleep mode, press **Start** and **Options** simultaneously in Step 3.

Setting the LCD Contrast

You can change the contrast to help the LCD look lighter or darker.

- 1 Press **Menu** and ▲ or ▼ to select 1.General Setup.
Press **Set**.
- 2 Press ▲ or ▼ to select 5.LCD Contrast.

General Setup
5.LCD Contrast

 Press **Set**.
- 3 Press ▲ or ▼ to select Light or Dark.
Press **Set**.
- 4 Press **Stop/Exit**.

Printing the User Settings List

You can print a list of your settings.

- 1 Press **Menu** and ▲ or ▼ to select 1.General Setup.
Press **Set**.
- 2 Press ▲ or ▼ to select 6.User Settings.

General Setup
6.User Settings

 Press **Set**.
- 3 Press **Start**.

Using the machine as a copier

You can use your machine as a copier, making up to 99 copies at a time.

The printable area of your machine begins at approximately 2 mm from both sides and 3 mm from the top or bottom of the paper.

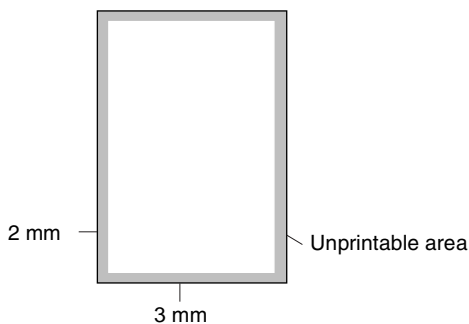

Note

The printable area shown above is for a single copy or a 1 in 1 copy using A4 size paper. The printable area changes with the paper size.

Making a single copy

- 1 Load your document.
- 2 Press **Start**.

Making multiple copies

- 1 Load your document.
- 2 Press **Number of Copies** repeatedly until the number of copies you want appears (up to 99).

—OR—

Press **Number of Copies**, and then press or hold ▲ or ▼ to increase or decrease the number of copies.



Note

DCP-7025 only:

To sort the copies, press **Options** and ▲ or ▼ to select *Stack/Sort*. (See *Sorting copies using the ADF (DCP-7025 only)* on page 3-5.)

- 3 Press **Start**.

Stop copying

To stop copying, press **Stop/Exit**.

Using the Temporary Copy keys

When you want to quickly change the copy settings temporarily for the next copy, use the Temporary Copy keys. You can use different combinations.

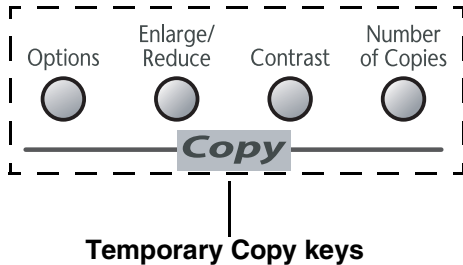

Note

- The machine returns to its default settings 60 seconds after it finishes copying.
- You can save the copy settings you use most often by setting them as default. (See *Changing the default copy settings* on page 3-7.)

Enlarging or reducing the image copied

You can select the following enlargement or reduction ratios.

Auto* sets the machine to calculate the reduction ratio that best fits the size of paper.

Custom (25-400%) allows you to enter a ratio from 25% to 400%.

Press Enlarge/Reduce 	100%
	104% EXE→LTR
	141% A5→A4
	200%
	Auto*
	Custom (25-400%)
	50%
	70% A4→A5
	78% (LGL→LTR)
	83% (LGL→A4)
	85% LTR→EXE
	91% Full Page
	94% A4→LTR
97% LTR→A4	

* DCP-7025 only



Note

DCP-7025 only:

Auto is available only when loading from the ADF.

- 1 Load your document.
- 2 Press **Enlarge/Reduce**.

- 3 Press ▲ or ▼ to select the enlargement or reduction ratio you want.

Press **Set**.

—OR—

You can select **Custom** (25-400%) and press **Set**.

Press ▲ or ▼ to enter an enlargement or reduction ratio from 25% to 400%.

Press **Set**.



Note

Enlargement or reduction ratio can also be increased or decreased by holding down ▲ or ▼.

- 4 Press **Start**.

—OR—

Press other temporary copy keys for more settings.



Note

- Special Copy Options (2 in 1 (P), 2 in 1 (L), 4 in 1 (P), 4 in 1 (L) or **Poster** (3 x 3)) are not available with **Enlarge/Reduce**.
- (P) means Portrait and (L) means Landscape.

Adjusting contrast

You can change the contrast to help an image look sharper and more vivid.

- 1 Load your document.

- 2 Press **Contrast**.



- 3 Press ▲ to increase the contrast.

—OR—

Press ▼ to decrease the contrast.

Press **Set**.



- 4 Press **Start**.

—OR—

Press other temporary copy keys for more settings.

Changing the temporary copy settings

Use the **Options** key to quickly set the following copy settings temporarily for the next copy.

Press 	Menu Selections  Select & Set	Options  Select & Set	Page
	Quality	Auto Text Photo	3-5
	Stack/Sort (DCP-7025 only)	Stack Sort	3-5
	Page Layout	Off(1 in 1) 2 in 1 (P) 2 in 1 (L) 4 in 1 (P) 4 in 1 (L) Poster(3 x 3)	3-5



Note

The factory settings are shown in **Bold**.

After you choose your settings by pressing **Set**, the LCD shows `Set temporarily`.

Press **Start** if you have finished choosing settings.



Quality

You can select the copy quality. The default setting is *Auto*.

Auto	Suitable for documents that contain both text and photographs.
Text	Suitable for documents containing only text.
Photo	Suitable for copying photographs.

- 1 Load your document.
- 2 Press **Options** and ▲ or ▼ to select **Quality**.
Press **Set**.
- 3 Press ▲ or ▼ to select the copy quality you want (*Auto*, *Text* or *Photo*).
Press **Set**.
- 4 Press **Start**.

Sorting copies using the ADF (DCP-7025 only)

You can sort multiple copies. Pages will be stacked in the order  (1, 2, 3),  (1, 2, 3) and so on.

- 1 Load your document.
- 2 Press **Number of Copies** repeatedly until the number you want appears (up to 99).
- 3 Press **Options** and ▲ or ▼ to select **Stack/Sort**.
Press **Set**.
- 4 Press ▲ or ▼ to select **Sort**.
Press **Set**.
- 5 Press **Start**.

Making N in 1 copies (Page Layout)

You can reduce the amount of copies by using the N in 1 copy feature. This allows you to copy two or four pages onto one page, allowing you to save paper.



Note

- Please make sure paper size is set to *A4* or *Letter*.
- You can use the N in 1 copy feature with 100% copy size only.
- (P) means Portrait and (L) means Landscape.

- 1 Load your document.
- 2 Press **Number of Copies** repeatedly until the number you want appears (up to 99).
- 3 Press **Options** and ▲ or ▼ to select **Page Layout**.
Press **Set**.
- 4 Press ▲ or ▼ to select 2 in 1 (P), 2 in 1 (L), 4 in 1 (P), or 4 in 1 (L).
Press **Set**.
- 5 Press **Start** to scan the document.

If you are using the scanner glass:

- 6 After the machine scans the page, the LCD shows:



Press ▲ to scan the next page.

- 7 Put the next document on the scanner glass.



Press **Set**.

Repeat Steps 6 and 7 for each page of the layout.

- 8 After all the pages of the document have been scanned, press ▼ to end.

Place document face down on the scanner glass in the direction shown below.

2 in 1 (P)



2 in 1 (L)

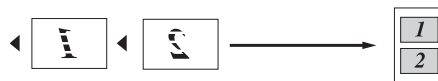

4 in 1 (P)



4 in 1 (L)

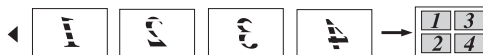

Place document face up in the ADF in the direction shown below. (DCP-7025 only)

2 in 1 (P)



2 in 1 (L)

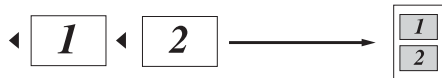

4 in 1 (P)



4 in 1 (L)



Making a poster (Page Layout)

You can create a poster. When you use the Poster feature your machine divides your document into sections, then enlarges the sections so you can assemble them into a poster. If you want to print a poster, use the scanner glass.



Note

- Please make sure paper size is set to A4 or Letter.
- For Poster copies, you cannot make more than one copy or use the Enlarge/Reduce feature.

- 1 Load your document.
- 2 Press **Options** and ▲ or ▼ to select **Page Layout**.
Press **Set**.
- 3 Press ▲ or ▼ to select **Poster (3 x 3)**.
Press **Set**.
- 4 Press **Start** to scan the document.

Poster (3x3)

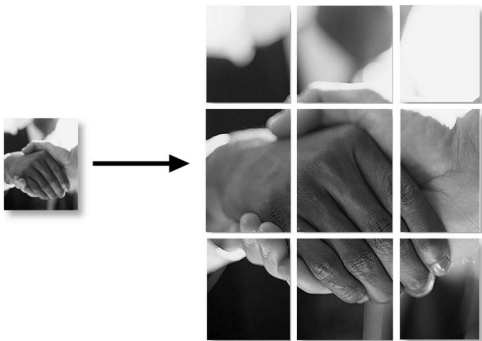

Changing the default copy settings

You can save the copy settings you use most often by setting them as default. These settings will remain until you change them again.







Quality

- 1 Press **Menu** and ▲ or ▼ to select **2.Copy**.
Press **Set**.
- 2 Press ▲ or ▼ to select **1.Quality**.

Press **Set**.
- 3 Press ▲ or ▼ to select **Auto, Text or Photo**.
Press **Set**.
- 4 Press **Stop/Exit**.

Adjusting contrast

You can change the contrast to help an image look sharper and more vivid.

- 1 Press **Menu** and  or  to select 2.Copy.
Press **Set**.
- 2 Press  or  to select 2.Contrast.

Press **Set**.
- 3 Press  to increase the contrast.
—OR—
Press  to decrease the contrast.
Press **Set**.
- 4 Press **Stop/Exit**.

Out of Memory message

If the memory becomes full while you are making copies, the LCD message will guide you through the next step.

For DCP-7025:

If the *Out of Memory* message appears when you are scanning the first page of your document, press **Stop/Exit** and wait until the other operations in process finish and then try again.

If you were scanning subsequent pages, press **Stop/Exit** to cancel or **Start** to copy the scanned pages.

For DCP-7010L:

If the *Out of Memory* message appears, press **Stop/Exit** and wait until the other operations in process finish and then try again.

4

Software Features

The User's Guide on the CD-ROM includes the Software User's Guide for features available when connected to a computer (for example, Printing and Scanning). The availability of the features listed below varies by model:

- Using the machine as a Printer (See Chapter 1 in the Software User's Guide on the CD-ROM.)
- How to Scan (See Chapter 2 in the Software User's Guide on the CD-ROM.)
- Using ControlCenter2.0 (See Chapter 3 in the Software User's Guide on the CD-ROM.)

5

Important information

IEC 60825-1 Specification

This machine is a Class 1 laser product as defined in IEC 60825-1 specifications. The label shown below is attached in countries where required.



This machine has a Class 3B Laser Diode which emits invisible laser radiation in the Scanner Unit. The Scanner Unit should not be opened under any circumstances.

Laser Diode

Wave length: 770 - 810 nm
Output: 5 mW max.
Laser Class: Class 3B



WARNING

Use of controls, adjustments or performance of procedures other than those specified in this manual may result in hazardous radiation exposure.

Disconnect device

This product must be installed near an electrical socket that is easily accessible. In case of emergency, you must disconnect the power cord from the electrical socket to shut off the power completely.

Wiring information Important

If you need to replace the plug fuse, fit a fuse that is approved by ASTA to BS1362 with the same rating as the original fuse.

Always replace the fuse cover. Never use a plug that does not have a cover.

Warning - This printer must be earthed.

The wires in the mains lead are coloured in line with the following code:

Green and Yellow: Earth

Blue: Neutral

Brown: Live

If in any doubt, call a qualified electrician.

Radio interference (220-240V Model Only)

This product complies with EN55022(CISPR Publication 22)/Class B.

Before this product is used, ensure that you use the following interface cables.

- 1 A shielded parallel interface cable with twisted-pair conductors and that is marked "IEEE 1284 compliant". The cable must not exceed 2.0 meters in length.
- 2 A USB cable. The cable must not exceed 2.0 meters in length.

Important safety instructions

- 1 Read all of these instructions.
- 2 Save them for later reference.
- 3 Follow all warnings and instructions marked on the product.
- 4 Unplug this product from the wall socket before cleaning inside of the machine. Do not use liquid or aerosol cleaners. Use a damp cloth for cleaning.
- 5 Do not use this product near water.
- 6 Do not place this product on an unstable cart, stand, or table. The product may fall, causing serious damage to the product.
- 7 Slots and openings in the cabinet and the back or bottom are provided for ventilation; to ensure reliable operation of the product and to protect it from overheating, these openings must not be blocked or covered. The openings should never be blocked by placing the product on a bed, sofa, rug, or other similar surface. This product should never be placed near or over a radiator or heater. This product should never be placed in a built-in installation unless proper ventilation is provided.
- 8 This product should be operated from the type of power source indicated on the label. If you are not sure of the type of power available, call your dealer or local power company.
- 9 Use only the power cord supplied with this machine.
- 10 This product is equipped with a 3-wire grounded plug. This plug will only fit into a grounded power outlet. This is a safety feature. If you are unable to insert the plug into the outlet, call your electrician to replace your obsolete outlet. Do not defeat the purpose of the grounded plug.

- 11 Do not allow anything to rest on the power cord. Do not place this product where people can walk on the cord.
- 12 Do not place anything in front of the machine that will block printing. Do not place anything in the path of printing.
- 13 Wait until pages have exited the machine before picking them up.
- 14 Unplug this product from the power socket and refer servicing to Authorized Service Personnel under the following conditions:
 - When the power cord is damaged or frayed.
 - If liquid has been spilled into the product.
 - If the product has been exposed to rain or water.
 - If the product does not operate normally when the operating instructions are followed. Adjust only those controls that are covered by the operating instructions. Improper adjustment of other controls may result in damage and will often require extensive work by a qualified technician to restore the product to normal operation.
 - If the product has been dropped or the cabinet has been damaged.
 - If the product exhibits a distinct change in performance, indicating a need for service.
- 15 To protect your product against power surges, we recommend the use of a power protection device (Surge Protector).
- 16 To reduce the risk of fire, electric shock and injury to people, note the following:
 - Do not use this product near appliances that use water, a swimming pool or in a wet basement.
 - Use only the power cord supplied with this machine.

Trademarks

The Brother logo is a registered trademark of Brother Industries, Ltd.

Brother is a registered trademark of Brother Industries, Ltd.

Multi-Function Link is a registered trademark of Brother International Corporation.

Windows and Microsoft are registered trademarks of Microsoft in the U.S. and other countries.

Macintosh and TrueType are registered trademarks of Apple Computer, Inc.

PaperPort and OmniPage OCR are registered trademarks of ScanSoft, Inc.

Presto! PageManager is a registered trademark of NewSoft Technology Corporation.

Each company whose software title is mentioned in this manual has a Software License Agreement specific to its proprietary programs.

All other brand and product names mentioned in this User's Guide, and the Software User's Guide are registered trademarks of their respective companies.

Troubleshooting

Error messages

As with any sophisticated office product, errors may occur. If this happens, your machine identifies the problem and displays an error message. The most common error messages are shown below.

You can correct most problems by yourself. If you need more help, the Brother Solutions Center offers latest FAQs and troubleshooting tips.

Visit us at <http://solutions.brother.com>.

ERROR MESSAGES		
ERROR MESSAGE	CAUSE	ACTION
Back Cover Open	The back cover is not completely closed.	Close the back cover of the machine.
Change Drum Soon	The drum unit is near the end of its life.	Use the drum unit until you have a print quality problem; then replace the drum unit with a new one. See <i>Replacing the drum unit (DR-2000)</i> on page 6-23.
Cooling Down Wait for a while	The temperature of the drum unit or toner cartridge is too hot. The machine will pause its current print job and go into cooling down mode. During the cooling down mode, you will hear the cooling fan running while the display on the machine shows <i>Cooling Down</i> , and <i>Wait for a while</i> .	You must wait 20 minutes for it to cool.
Cover is Open	The front cover is not completely closed.	Close the front cover for the drum unit.
Data Remaining	Print data is left in the machine's memory.	Re-start printing from your computer.
	Print data is left in the machine's memory. The USB or Parallel cable was unplugged while the computer was sending the data to the machine.	Press Job Cancel . The machine will cancel the job and eject the page that is being printed. Try to print again.
Document Jam (DCP-7025 only)	The document was not inserted or fed properly or the document scanned from the ADF was too long.	See <i>Document jams (DCP-7025 only)</i> on page 6-3. See <i>Using the automatic document feeder (ADF) (DCP-7025 only)</i> on page 1-4.
Drum Error	The drum unit needs to be cleaned.	See <i>Cleaning the corona wire</i> on page 6-19.
Fail to Warm up	The fuser unit is too cold.	Turn off the machine's power switch, and check the machine's environment. If it is in a location that is too cold or too hot, try to cool or warm the room by turning on the air conditioner or heater. Or, change the location. Then, turn on the machine's power switch.
Unit is too Hot	The fuser unit is too hot.	

ERROR MESSAGES		
ERROR MESSAGE	CAUSE	ACTION
Machine too Hot	The inside of the machine is too hot.	Listen to the machine to check that the cooling fan is spinning. Make sure that the air vents are not covered up or blocked. If the fan is spinning and air vents are clear, you should let the machine cool down for several minutes before using it again. If the fan is not spinning, turn off the machine and then on again.
No cartridge	The toner cartridge is not installed properly.	Reinstall the toner cartridge.
No Paper Fed	The machine is out of paper or paper is not properly loaded in the paper tray.	Refill the paper in the paper tray and then press Start . —OR— Remove the paper and load it again and then press Start .
Out of Memory	The machine's memory is full.	(Copy operation in process) Press Stop/Exit and wait until the other operations in process finish and then try again. (Printing operation in process) Reduce print resolution. (See <i>Advanced tab</i> in the Software User's Guide on the CD-ROM.)
Paper jam Inside	The paper is jammed inside the machine.	(See <i>Paper jams</i> on page 6-4.)
Paper Jam Rear	The paper is jammed in the back of the machine.	(See <i>Paper jams</i> on page 6-4.)
Paper Jam Tray	The paper is jammed in the paper tray of the machine.	(See <i>Paper jams</i> on page 6-4.)
Scanner Locked	The scanner glass's sensor does not move to the home position.	Turn off the machine and then on again.
Toner Life End	The toner cartridge and drum unit assembly are not installed or it is not installed properly. —OR— Toner is used up and printing is not possible.	Re-install the toner cartridge and drum unit assembly. —OR— Replace the toner cartridge with a new one. (See <i>Replacing the toner cartridge (TN-2000)</i> on page 6-20.)
Toner Low	The toner cartridge is near the end of its life and will soon need replacing.	Order a new toner cartridge now.
Unable to Init. (Initialize) Unable to Print Unable to Scan	The machine has a mechanical problem.	Turn off the machine's power switch, and then on again. If the error message continues, leave the machine for several minutes, and then try to print, copy or scan again.

Document jams (DCP-7025 only)

If the document is jammed, follow the steps below.

Document is jammed in the top of the ADF unit

- 1 Take out any paper from the ADF that is not jammed.
- 2 Open the ADF cover.
- 3 Pull the jammed document out to the left.

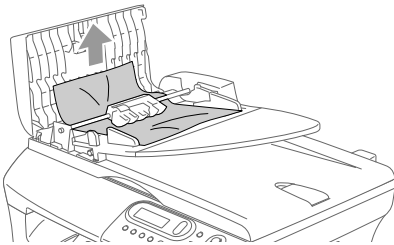

- 4 Close the ADF cover.
- 5 Press **Stop/Exit**.

Document is jammed inside the ADF unit

- 1 Take out any paper from the ADF that is not jammed.
- 2 Lift the document cover.
- 3 Pull the jammed document out to the right.

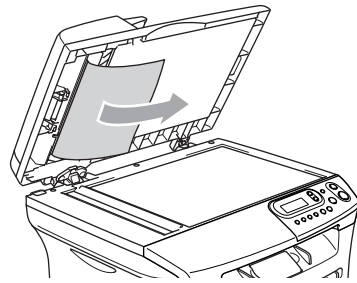

- 4 Close the document cover.
- 5 Press **Stop/Exit**.
—OR—
- 1 Pull the jammed document out to the right.

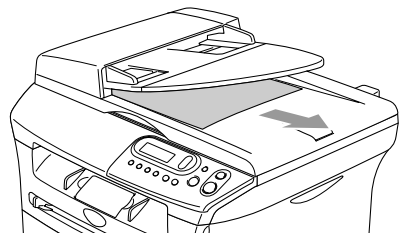

- 2 Press **Stop/Exit**.

Paper jams

To clear paper jams, please follow the steps in this section.

! WARNING

After you have just used the machine, some parts inside the machine are extremely hot. When you open the front cover or back cover of the machine, never touch the shaded parts shown in the following diagram.

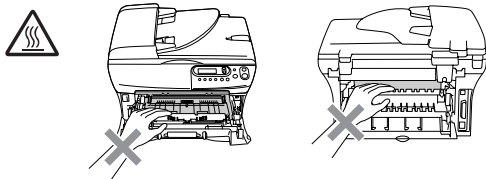

Paper is jammed inside the machine

- 1 Pull the paper tray completely out of the machine.
- 2 Pull the jammed paper up and out of the paper tray opening.

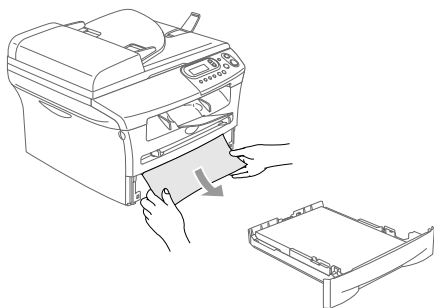

- 3 Open the front cover.

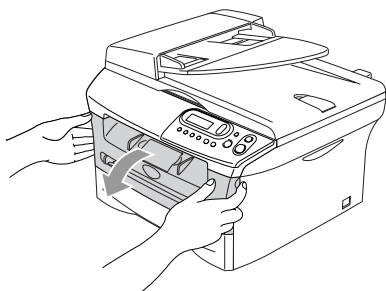

- 4 Pull out the drum unit and toner cartridge assembly. The jammed paper may be pulled out with the toner cartridge and drum unit assembly, or this may release the paper so you can pull it up and out of the paper tray opening.

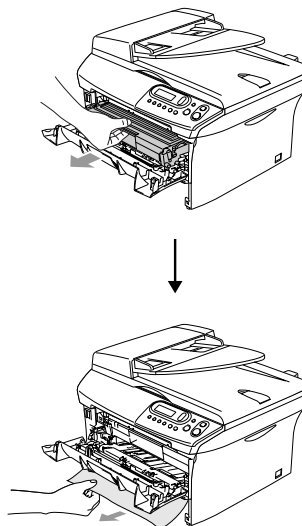

- 5 If you cannot remove the drum unit and toner cartridge assembly easily, do not use extra force. Instead, lift the scanner cover and use both hands to carefully pull the jammed paper up and out of the output tray opening.

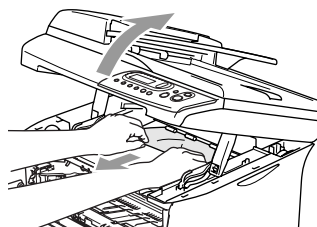

! CAUTION

To prevent damage to the machine caused by static electricity, do not touch the electrodes shown in the following diagram.

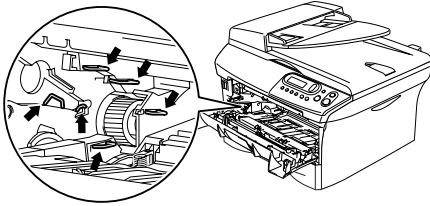

- 6 Put the drum unit and toner cartridge assembly back in the machine.

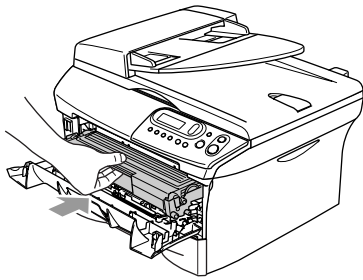

- 7 Close the front cover.
8 Put the paper tray in the machine.

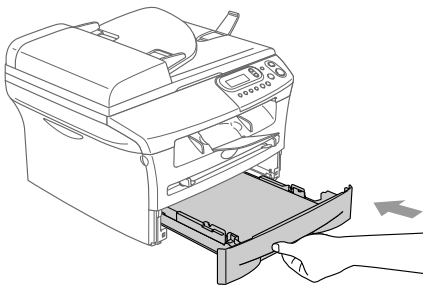

Paper is jammed at back of the machine

- 1 Open the front cover.

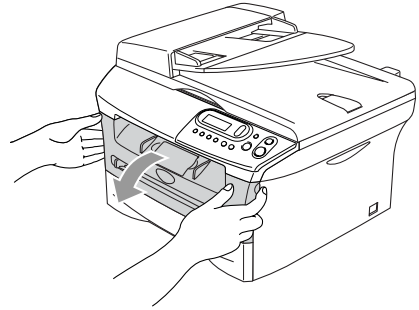

- 2 Pull out the drum unit and toner cartridge assembly.

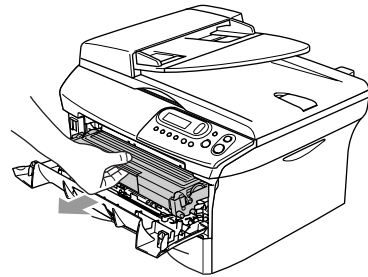

- 3 Open the back cover.

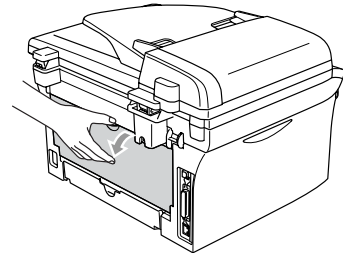

- 4 Pull the tab toward you to open the rear chute cover.

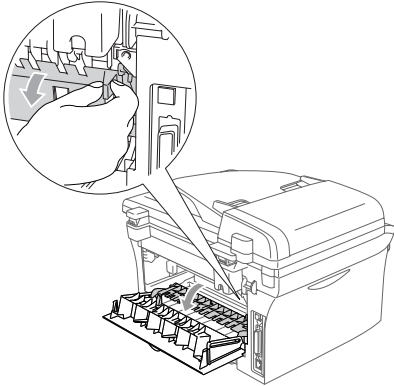

- 7 Put the drum unit and toner cartridge assembly back into the machine.

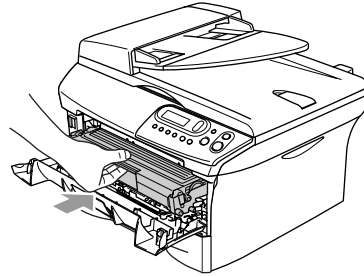

- 8 Close the front cover.

- 5 Pull the jammed paper out of the fuser unit. If the jammed paper cannot be pulled out easily, push down the blue tab with one hand as you gently pull the paper out with other hand.

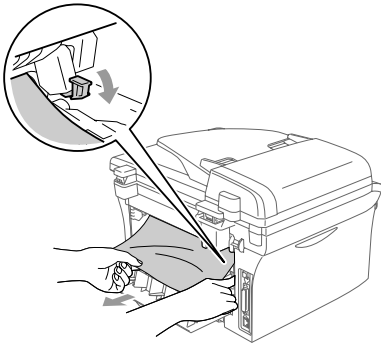

- 6 Close the back cover.

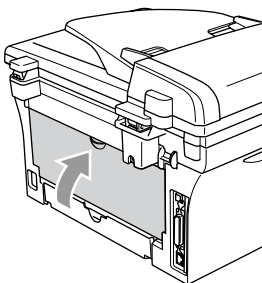

Paper is jammed inside the drum unit and toner cartridge assembly

- 1 Open the front cover.

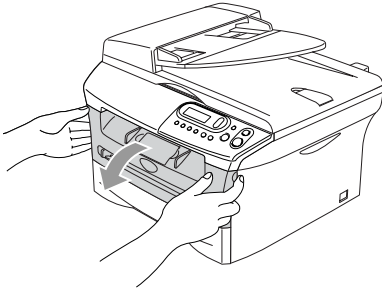

- 2 Pull out the drum unit and toner cartridge assembly.

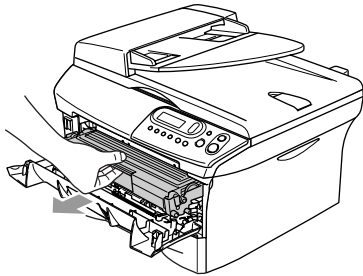

- 3 Hold down the lock lever on the left and pull the toner cartridge out of the drum unit. Take out the jammed paper if there is any inside the drum unit.

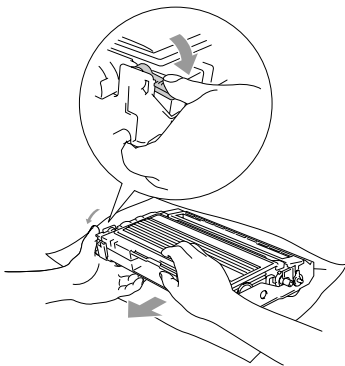

- 4 Put the toner cartridge back into the drum unit until you hear it lock into place. If you put it in properly, the lock lever will lift automatically.

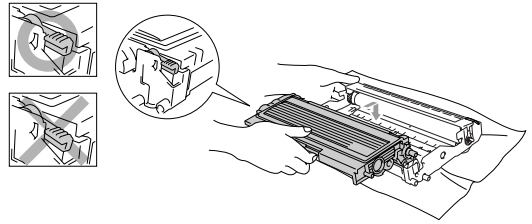

- 5 Put the drum unit and toner cartridge assembly back in the machine.

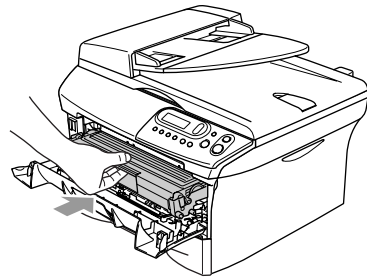

- 6 Close the front cover.

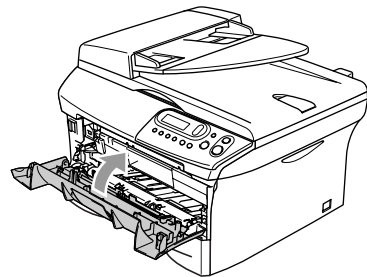

If you are having difficulty with your machine

If you think there is a problem with your machine, check the chart below and follow the troubleshooting tips.

The Brother Solutions Center offers the latest FAQs and troubleshooting tips.

Visit us at <http://solutions.brother.com>.





DIFFICULTY	SUGGESTIONS
Printing Difficulties	
Poor print quality	See <i>Improving the print quality</i> on page 6-11.
Vertical black lines.	Sometimes you may see vertical streaks/black lines on the printed pages. The drum unit's primary corona wire for printing may be dirty. Clean your primary corona wire (See <i>Cleaning the corona wire</i> on page 6-19).
Copy Quality Difficulties	
Vertical black streaks or black spots appear in copies.	Sometimes you may see vertical streaks on your copies. Either the scanner or the drum unit's primary corona wire for printing is dirty. Clean them both. (See <i>Cleaning the scanner glass</i> on page 6-17 and <i>Cleaning the corona wire</i> on page 6-19.)
Printer Difficulties	
The machine does not print.	<p>Please make sure:</p> <ul style="list-style-type: none"> • The machine is plugged in and the power switch is turned on. <p>—OR—</p> <ul style="list-style-type: none"> • The toner cartridge and drum unit are installed properly. (See <i>Replacing the drum unit (DR-2000)</i> on page 6-23.) <p>—OR—</p> <ul style="list-style-type: none"> • The interface cable is securely connected between the machine and computer. (See the Quick Setup Guide.) <p>—OR—</p> <ul style="list-style-type: none"> • Check to see if LCD is showing an error message. (See <i>Error messages</i> on page 6-1.) <p>—OR—</p> <ul style="list-style-type: none"> • Machine is online. Click Start and then Printer and Faxes. Right-click the 'Brother DCP-7010 or DCP-7025'. Make sure that "Use Printer Offline" is unchecked.
The machine prints unexpectedly or it prints garbage.	Turn off the machine's power switch and then on it again. Check the primary settings in your application software to make sure it is set up to work with your machine.
The machine prints first couple of pages correctly, then some pages have text missing.	Your computer is not recognizing the machine's input buffer full signal. Please make sure you connect the machine cable correctly. (See the Quick Setup Guide.)
The machine cannot print full pages of a document. <i>Out of Memory</i> message occurs.	<p>Reduce the printing resolution. (See <i>Advanced tab</i> in the Software User's Guide on the CD-ROM.)</p> <p>Reduce the complexity of your document and try again. Reduce the graphic quality or the number of font sizes within your application software.</p>
My headers or footers appear when I view my document on the screen but do not appear when I print them.	Your machine can print 62 lines per page. The top two lines and bottom two lines are a restricted area that will not accept print. Adjust the top and bottom margins in your document to allow for this.





DIFFICULTY	SUGGESTIONS
Scanning Difficulties	
TWAIN errors appear while scanning.	Make sure the Brother TWAIN driver is selected as the primary source. In PaperPort®, click Scan in the File menu and select the Brother TWAIN driver.
Software Difficulties	
Cannot install software or print.	Run the Repair MFL-Pro Suite program on the CD-ROM. This program will repair and reinstall the software.
Cannot perform '2 in 1 or 4 in 1' printing.	Check that the paper size setting in the application and in the printer driver are the same.
Cannot print when using Adobe Illustrator.	Try to reduce the print resolution. (See <i>Advanced tab</i> in the Software User's Guide on the CD-ROM.)
When using ATM fonts, some characters are missing or some characters are printed in their place.	If you are using Windows® 98/98SE/Me, select 'Printer Settings' from the 'Start' menu. Select the properties of the 'Brother DCP-7010 or DCP-7025'. Click 'Spool Setting' on the 'Details' tab. Select 'RAW' from 'Spool Data Format'.
'Unable to write to LPT1' or 'LPT1 already in use' Error Message appears.	<ol style="list-style-type: none"> 1. Make sure the machine is on (plugged into the electrical socket and the power switch turned on) and that it is connected directly to the computer using the IEEE-1284 bi-directional parallel cable. The cable must not go through another peripheral device (such as a Zip Drive, External CD-ROM Drive, or Switch box). 2. Make sure the machine is not displaying an error message on the LCD Display. 3. Make sure no other device drivers, which also communicate through the parallel port, are running automatically when you boot up the computer (such as, drivers for Zip Drives, External CD-ROM Drive, etc.) Suggested areas to check: (<i>Load=, Run=command lines in the win.ini file or the Setup Group</i>) 4. Check with your computer manufacturer to confirm that the computer's parallel port settings in the BIOS are set to support a bi-directional machine; i.e. (Parallel Port Mode – ECP)
'MFC is Busy' Error Message appears.	



DIFFICULTY	SUGGESTIONS
Paper Handling Difficulties	
The machine does not load paper. The LCD shows <code>No Paper Fed</code> or <code>Paper Jam</code> .	If there is no paper, load a new stack of paper into the paper tray. If there is paper in the paper tray, make sure it is straight. If the paper is curled, you should straighten it. Sometimes it is helpful to remove the paper, turn the stack over and put it back into the paper tray. Reduce the amount of paper in the paper tray, and then try again. Check that the manual feed mode is not selected in the printer driver. If the LCD shows <code>Paper Jam</code> and you still have a problem, see <i>Paper jams</i> on page 6-4.
The machine does not feed paper from the manual feed slot.	Reinsert the paper firmly, load one sheet at a time. Make sure that manual feed mode is selected in the printer driver.
How can I load envelopes?	You can load envelopes from the manual feed slot. Your application software must be set up to print the envelope size you are using. This is usually done in the Page Setup or Document Setup menu of your software. You should refer to the manual provided with your software application.
What paper can I use?	You can use plain paper, recycled paper, envelopes, transparencies and labels that are made for laser machines. (For information on paper you can use, see <i>About paper</i> on page 1-6.)
How can I clear paper jams?	See <i>Paper jams</i> on page 6-4.
Print Quality Difficulties	
Printed pages are curled.	Low quality thin or thick paper can cause this problem. Make sure you select the Paper Type that suits the media type you use. (See <i>About paper</i> on page 1-6.)
Printed pages are smeared.	The Paper Type setting may be incorrect for the type of print media you are using— OR —The print media may be too thick or have a rough surface. (See <i>About paper</i> on page 1-6 and <i>Basic tab</i> in the Software User's Guide on the CD-ROM.)
Printouts are too light.	If your machine is not connected to a computer, turn off Toner Save mode in the machine's menu setting. (See <i>Toner Save</i> on page 2-2.) Set Toner Save mode to off in the Advanced tab in the printer driver. (See <i>Advanced tab</i> in the Software User's Guide on the CD-ROM.) If the printout is a copy, adjust the contrast. (See <i>Adjusting contrast</i> on page 3-8.)

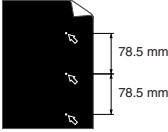
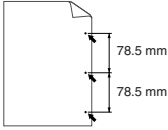
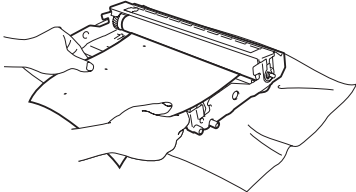

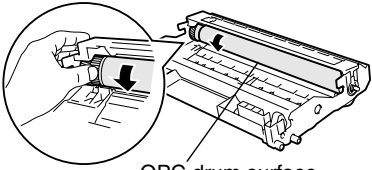
Improving the print quality

This section provides information on the following topics:

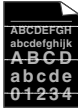
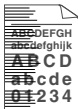
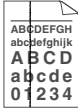
Examples of poor print quality	Recommendation
 <p>Faint</p>	<p>Check the machine's environment. Conditions such as humidity, high temperatures, and so on may cause this print fault. (See <i>Choosing a location</i> on page 1-2.)</p> <p>If the whole page is too light, Toner Save mode may be on. Turn off Toner Save mode in the machine menu settings or in the printer driver. (See <i>Toner Save</i> on page 2-2 or <i>Advanced tab</i> in the Software User's Guide on the CD-ROM.)</p> <p>—OR—</p> <p>If your machine is not connected to a computer, turn off Toner Save mode in the machine's menu setting. (See <i>Toner Save</i> on page 2-2.)</p> <p>Clean the laser scanner window and the primary corona wire on the drum unit. (See <i>Cleaning the laser scanner window</i> on page 6-18 and <i>Cleaning the corona wire</i> on page 6-19.) If the print quality has not improved, install a new drum unit.</p> <p>Install a new toner cartridge. (See <i>Replacing the toner cartridge (TN-2000)</i> on page 6-20.)</p>
 <p>Gray background</p>	<p>Make sure that you use paper that meets the recommended specifications. (See <i>About paper</i> on page 1-6.)</p> <p>Check the machine's environment - high temperatures and high humidity can increase the amount of background shading. (See <i>Choosing a location</i> on page 1-2.)</p> <p>Install a new toner cartridge. (See <i>Replacing the toner cartridge (TN-2000)</i> on page 6-20.)</p> <p>Clean the primary corona wire on the drum unit. (See <i>Cleaning the corona wire</i> on page 6-19.) If the print quality has not improved, install a new drum unit. (See <i>Replacing the drum unit (DR-2000)</i> on page 6-23.)</p>
 <p>Ghost</p>	<p>Make sure you use paper that meets our specifications. Rough-surfaced paper or thick print media may cause this problem. (See <i>About paper</i> on page 1-6.)</p> <p>Make sure that you choose the appropriate media type in the printer driver or in the machine's Paper Type menu setting. (See <i>Basic tab</i> in the Software User's Guide on the CD-ROM and <i>Setting the Paper Type</i> on page 2-1 in this User's Guide.)</p> <p>Install a new drum unit. (See <i>Replacing the drum unit (DR-2000)</i> on page 6-23.)</p>
 <p>Toner specks</p>	<p>Make sure that you use paper that meets our specifications. Rough-surfaced paper may cause the problem. (See <i>About paper</i> on page 1-6.)</p> <p>Clean the primary corona wire and the drum unit. (See <i>Cleaning the corona wire</i> on page 6-19 and <i>Cleaning the drum unit</i> on page 6-12.) If the print quality has not improved, install a new drum unit. (See <i>Replacing the drum unit (DR-2000)</i> on page 6-23.)</p>
 <p>Hollow print</p>	<p>Make sure that you use paper that meets our specifications. (See <i>About paper</i> on page 1-6.)</p> <p>Choose Thick paper mode in the printer driver or in the machine's Paper Type menu setting, or use thinner paper than you are currently using. (See <i>Basic tab</i> in the Software User's Guide on the CD-ROM.)</p> <p>Check the machine's environment because conditions such as high humidity can cause hollow print. (See <i>Choosing a location</i> on page 1-2.)</p> <p>Clean the primary corona wire on the drum unit. (See <i>Cleaning the corona wire</i> on page 6-19.) If the print quality has not improved, install a new drum unit. (See <i>Replacing the drum unit (DR-2000)</i> on page 6-23.)</p>







Examples of poor print quality	Recommendation
 <p>All black</p>	<p>Clean the primary corona wire on the drum unit. (See <i>Cleaning the corona wire</i> on page 6-19.)</p> <p>If the print quality has not improved, install a new drum unit. (See <i>Replacing the drum unit (DR-2000)</i> on page 6-23.)</p>
 <p>White Spots on black text and graphics at 78.5 mm intervals</p>  <p>Black Spots at 78.5 mm intervals</p>	<h2 style="text-align: center;">Cleaning the drum unit</h2> <p>Dust, paper powder, glue, and so on may stick to the surface of the photosensitive drum (OPC) and cause black or white spots to appear on printed documents.</p> <p>Make a few copies of a blank, white sheet of paper. (See <i>Making multiple copies</i> on page 3-1.)</p> <ol style="list-style-type: none"> 1 Remove the drum unit and toner cartridge assembly, and then remove the toner cartridge from the drum unit. 2 Position the print sample in front of the drum unit so you will know the exact position on the drum that is causing the poor print. <div style="text-align: center;">  </div> 3 Turn the black gear on the drum as you check the surface of the OPC drum. <div style="text-align: center;">  <p>Do not touch the OPC drum with your fingers.</p> <div style="text-align: center;">  <p>OPC drum surface</p> </div> </div> 4 When you find the substance on the drum surface that matches the print sample, gently <i>dab</i> the surface of the OPC drum with a cotton swab that is lightly dampened with isopropyl alcohol. <div style="text-align: center;">  </div> <div style="text-align: center;">  <p>Do not try to clean the surface of the OPC drum with a sharp object, such as a ball-point pen, because this might cause permanent damage to the drum unit.</p> </div> <p>If the print quality still has not improved you need to install a new drum. (See <i>Replacing the drum unit (DR-2000)</i> on page 6-23.)</p>

Examples of poor print quality	Recommendation
 <p>Black toner marks across the page</p>	<p>Make sure that you use paper that meets our specifications. (See <i>About paper</i> on page 1-6.)</p> <p>If you use label sheets for laser printers, the glue from the sheets may sometimes stick to the OPC drum surface. Clean the drum unit. (See <i>Cleaning the drum unit</i> on page 6-12.)</p> <p>Do not use paper that has clips or staples because they will scratch the surface of the drum.</p> <p>If the unpacked drum unit is in direct sunlight or room light, the unit may be damaged.</p> <p>The drum unit may be damaged. Put in a new drum unit. (See <i>Replacing the drum unit (DR-2000)</i> on page 6-23.)</p>
 <p>White lines across the page</p>	<p>Make sure that you use paper that meets our specifications. A rough surfaced paper or thick print media can cause the problem. (See <i>About paper</i> on page 1-6.)</p> <p>Make sure that you choose the appropriate media type in the printer driver or in the machine's Paper Type menu setting. (See <i>Basic tab</i> in the Software User's Guide on the CD-ROM and <i>Setting the Paper Type</i> on page 2-1 in this User's Guide.)</p> <p>The problem may disappear by itself. Try printing multiple pages to clear this problem, especially if the machine has not been used for a long time.</p> <p>You may clear the problem by wiping the laser scanner window with a soft cloth. (See <i>Cleaning the laser scanner window</i> on page 6-18.)</p> <p>The drum unit may be damaged. Put in a new drum unit. (See <i>Replacing the drum unit (DR-2000)</i> on page 6-23.)</p>
 <p>Lines across the page</p>	<p>Clean the inside of the machine and the primary corona wire in the drum unit. (See <i>Cleaning the corona wire</i> on page 6-19.)</p> <p>You may clear the problem by wiping the laser scanner window with a soft cloth. (See <i>Cleaning the laser scanner window</i> on page 6-18.)</p> <p>The drum unit may be damaged. Put in a new drum unit. (See <i>Replacing the drum unit (DR-2000)</i> on page 6-23.)</p>
 <p>Black lines down the page Printed pages have toner stains down the page.</p>	<p>Clean the primary corona wire of the drum unit. (See <i>Cleaning the corona wire</i> on page 6-19.)</p> <p>Make sure the primary corona wire is at the home position (▲).</p> <p>The drum unit may be damaged. Install a new drum unit. (See <i>Replacing the drum unit (DR-2000)</i> on page 6-23.)</p> <p>The toner cartridge may be damaged. Put in a new toner cartridge. (See <i>Replacing the toner cartridge (TN-2000)</i> on page 6-20.) Make sure that a torn piece of paper is not inside the machine covering the laser scanner window.</p>
 <p>White lines down the page</p>	<p>You may clear the problem by wiping the laser scanner window with a soft cloth. (See <i>Cleaning the laser scanner window</i> on page 6-18.)</p> <p>The toner cartridge may be damaged. Put in a new toner cartridge. (See <i>Replacing the toner cartridge (TN-2000)</i> on page 6-20.)</p>
 <p>Page skewed</p>	<p>Make sure the paper or other print media is loaded properly in the paper tray and that the guides are not too tight or too loose against the paper stack.</p> <p>Set the paper guides correctly.</p> <p>If you are using the manual feed slot, see <i>To load paper or other media in the manual feed slot</i> on page 1-9.</p> <p>The paper tray may be too full.</p> <p>Check the paper type and quality. (See <i>About paper</i> on page 1-6.)</p>

Examples of poor print quality	Recommendation
 <p>Curl or wave</p>	<p>Check the paper type and quality. High temperatures and high humidity will cause paper to curl.</p> <p>If you don't use the machine very often, the paper may have been in the paper tray too long. Turn over the stack of paper in the paper tray. Also, fan the paper stack and then rotate the paper 180° in the paper tray.</p>
 <p>Wrinkles or creases</p>	<p>Make sure that paper is loaded properly.</p> <p>Check the paper type and quality. (See <i>About paper</i> on page 1-6.)</p> <p>Turn over the stack of paper in the tray or rotate the paper 180° in the input tray.</p>

How to change the LCD language

You can change the LCD language.

- 1 Press **Menu** and  or  to select 1.General Setup.
Press **Set**.
- 2 Press  or  to select 0.Local Language.
Press **Set**.
- 3 Press  or  to select your language.
Press **Set**.
- 4 Press **Stop/Exit**.

Packing and shipping the machine

When you transport the machine, use the packing materials that came with your machine. If you do not pack the machine properly, you could void your warranty.

- 1 Turn off the machine's power switch.
- 2 Unplug the machine from the electrical socket.
- 3 Unplug the cable from the machine.
- 4 Open the front cover.
- 5 Remove the drum unit and toner cartridge assembly. Leave the toner cartridge installed in the drum unit.
- 6 Place the drum unit and toner cartridge assembly into the plastic bag and seal the bag.
- 7 Close the front cover.

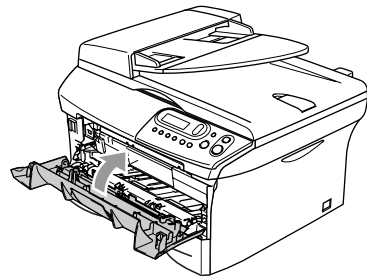

- 8 Wrap the machine in the plastic bag and place it in the original carton with the original packing material.

- 9 Pack the drum unit and toner cartridge assembly, AC power cord and printed materials in the original carton as shown below:

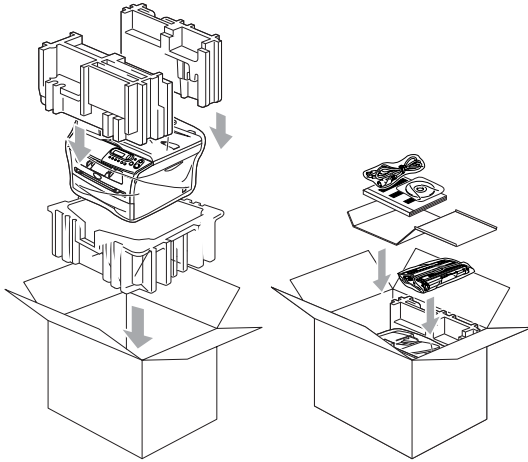

- 10 Close the carton and tape it shut.

Routine maintenance

! CAUTION

The drum unit contains toner, so handle it carefully. If toner scatters and your hands or clothes get dirty, immediately wipe or wash it off with cold water.

Cleaning the outside of the machine

! CAUTION

- Use neutral detergents. Cleaning with volatile liquids such as thinner or benzene will damage the outside surface of the machine.
- Do not use cleaning materials that contain ammonia.
- Do not use isopropyl alcohol to remove dirt from the control panel. It may crack the panel.

- 1 Pull the paper tray completely out of the machine.

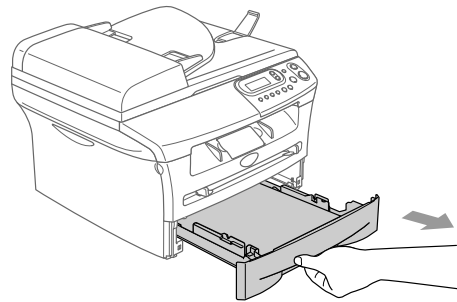

- 2 Wipe the outside of the machine with a soft cloth to remove dust.

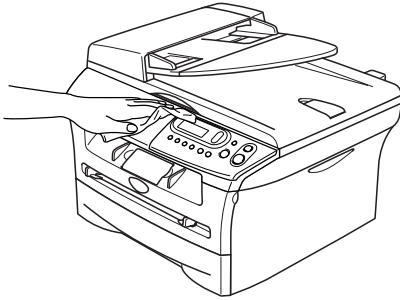

- 3 Remove anything that is stuck inside the paper tray.
- 4 Wipe the inside and the outside of the paper tray with a soft cloth to remove dust.

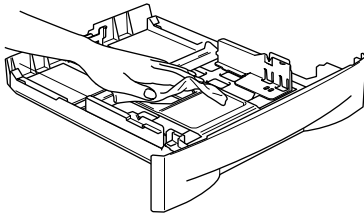

- 5 Re-load the paper and put the paper tray in the machine.

Cleaning the scanner glass

Turn off the machine's power switch and lift the document cover. Clean the scanner glass and the white plastic surface underneath the document cover with isopropyl alcohol and soft lint-free cloth.

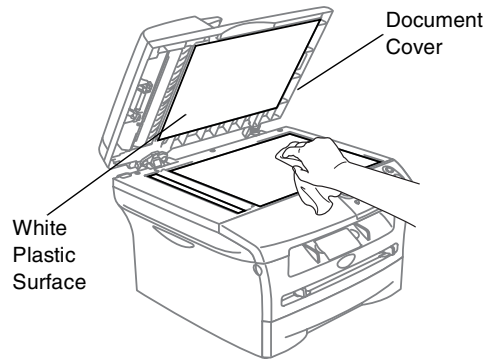

In the ADF unit, clean the white plastic bar and the scanner glass strip under the film with isopropyl alcohol on a lint-free cloth.

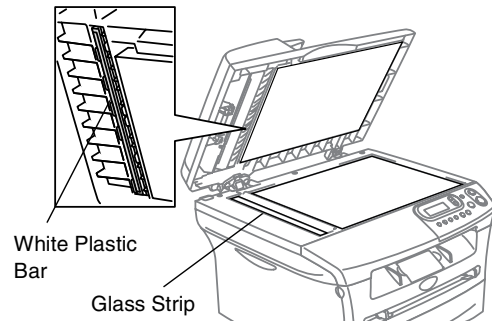

Cleaning the laser scanner window

! CAUTION

- Do *not* use isopropyl alcohol to clean the laser scanner window.
- Do *not* touch the laser scanner window with your fingers.

- 1 Before you clean the inside of the machine, turn off the machine's power switch.
- 2 Open the front cover and pull out the drum unit and toner cartridge assembly.

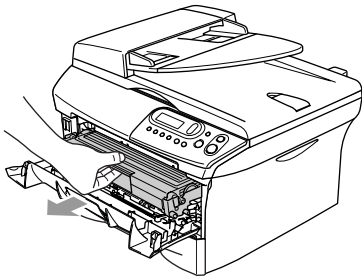

! WARNING

Just after you have used the machine, some internal parts of the machine are extremely **HOT!** When you open the front cover of the machine, never touch the shaded parts shown in the diagram below.

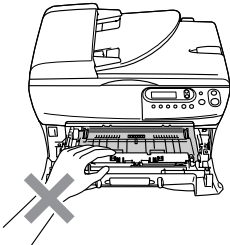

! CAUTION

To prevent damage to the machine from static electricity, do not touch the electrodes shown below.

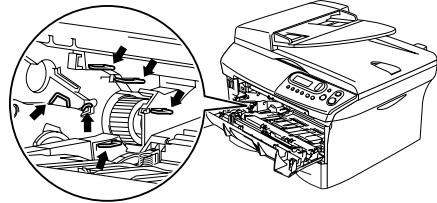

- 3 Gently clean the laser scanner window by wiping it with a clean soft, dry, lint-free cloth. Do not use isopropyl alcohol.

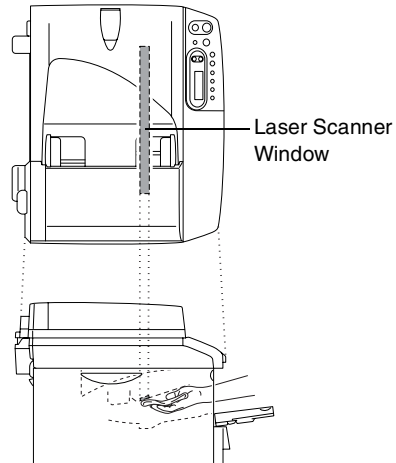

- Put the drum unit and toner cartridge assembly back into the machine.

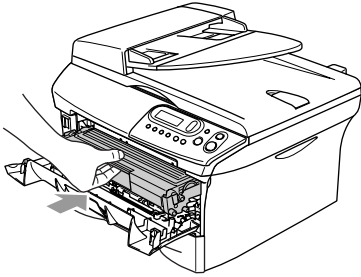

- Close the front cover.
- Turn on the machine's power switch.

Cleaning the corona wire

We recommend placing the drum unit and toner cartridge assembly on a cloth or large disposable paper to avoid spilling and scattering toner.

- Open the front cover and pull out the drum unit and toner cartridge assembly.

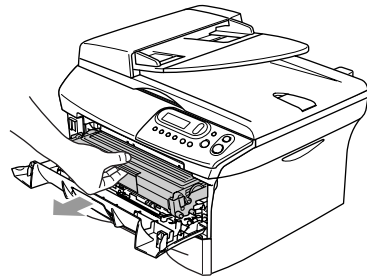

- Clean the primary corona wire inside the drum unit by gently sliding the blue tab from right to left several times.

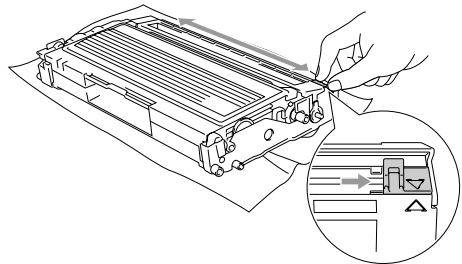

- Return the blue tab and snap it into the Home position (▼).

! CAUTION

If you do not return the blue tab to the Home position (▼), your printed pages may have vertical black stripes on them.

- Reinstall the drum unit and toner cartridge assembly in the machine.
- Close the front cover.

Replacing the toner cartridge (TN-2000)

The toner cartridge can print *up to* 2,500 pages. When the toner cartridge is running low, the LCD shows **Toner Low**. The machine is supplied with a starter toner cartridge that must be replaced after approximately 1,500 pages. Actual page count will vary depending on your average type of document (i.e., standard letter, detailed graphics).



Note

It is a good idea to keep a new toner cartridge ready for use when you see the **Toner Low** warning.

Discard the used toner cartridge according to local regulations, keeping it separate from domestic waste. You can also check our ecology website www.brothergreen.co.uk for recycling information. Be sure to seal the toner cartridge tightly so toner powder does not spill out of the cartridge. If you have questions, call your local waste disposal office.

We recommend that you clean the machine and drum unit when you replace the toner cartridge. (See *Cleaning the laser scanner window* on page 6-18 and *Cleaning the corona wire* on page 6-19.)

How to replace the toner cartridge



WARNING

Just after you use the machine, some internal parts of the machine will be extremely **HOT!** Never touch the shaded parts shown in the illustration.

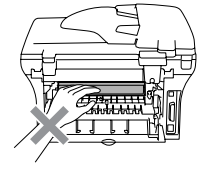
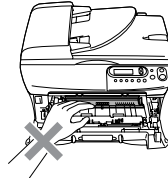

- 1 Open the front cover and pull out the drum unit and toner cartridge assembly.

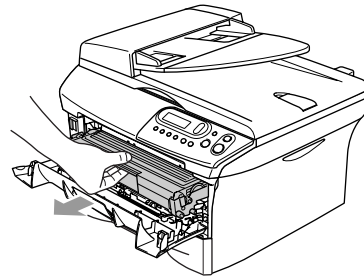

CAUTION

To prevent damage to the machine from static electricity, do not touch the electrodes shown below.

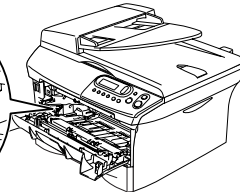
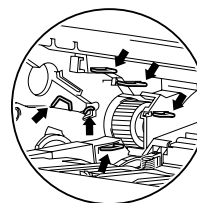

- 2 Hold down the lock lever on the left and pull the toner cartridge out of the drum unit.

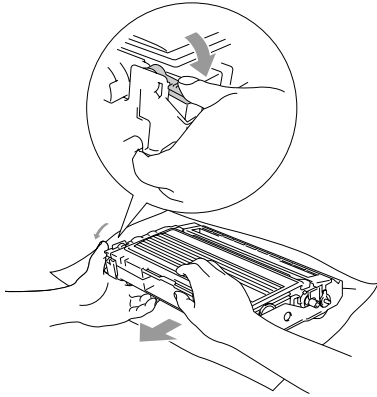

! CAUTION

- Place the drum unit on a drop cloth or large piece of disposable paper to avoid spilling and scattering the toner.
- Handle the toner cartridge carefully. If toner scatters on your hands or clothes, immediately wipe it off or wash it with cold water.

- 3 Unpack the new toner cartridge. Place the used toner cartridge into the aluminium bag and discard it according to local regulations.

! CAUTION

- Brother printers are designed to work with toner of a particular specification and work to a level of optimum performance when used with genuine Brother toner cartridges (**TN-2000**). Brother cannot guarantee this optimum performance if toner or toner cartridges of other specifications are used. Brother does not therefore recommend the use of cartridges other than Brother cartridges with this printer, or the refilling of empty cartridges with toner from other sources. If damage is caused to the drum unit or other part of this machine as a result of the use of toner or toner cartridges other than genuine Brother products due to the incompatibility or lack of suitability of those products with this machine, any repairs required as a result may not be covered by the warranty.
- Wait to unpack the toner cartridge until immediately before you install it in the machine. If a toner cartridge is left unpacked for a long period of time, the toner life is shortened.

! CAUTION

Do not touch the shaded parts shown in the illustrations to prevent any degradation to the print quality.

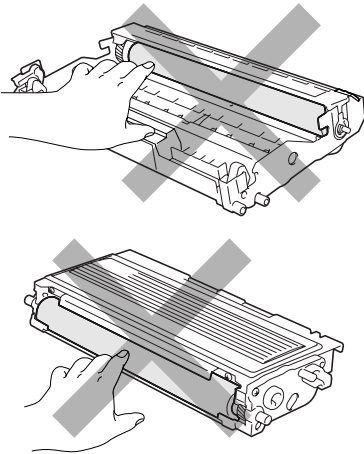

- 4 Gently rock the toner cartridge from side to side five or six times to distribute the toner evenly inside the cartridge.

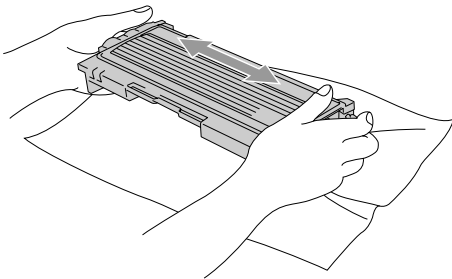

- 5 Remove the protective cover.

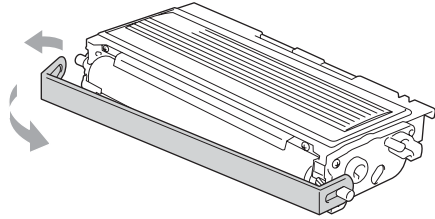

- 6 Insert the new toner cartridge in the drum unit until it clicks into place. If you put it in properly, the lock lever will lift automatically.

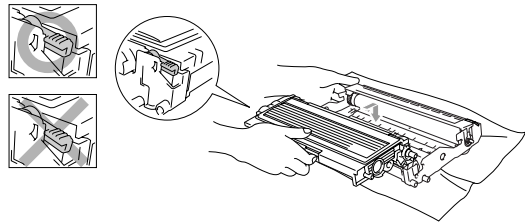

- 7 Clean the primary corona wire inside the drum unit by gently sliding the blue tab from right to left several times. Return the blue tab to the Home position (▼) before reinstalling the drum unit and toner cartridge assembly.

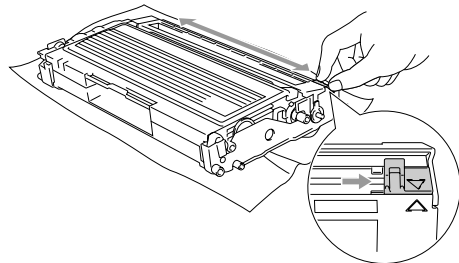

- 8 Install the drum unit and toner cartridge assembly into the machine.

- 9 Close the front cover.

Replacing the drum unit (DR-2000)

The machine uses a drum unit to create print images on paper. If the LCD shows *Change Drum Soon*, the drum unit is near the end of its life and it is time to buy a new one.

Even if the LCD shows *Change Drum Soon*, you may be able to continue printing without having to replace the drum unit for a while. However, if there is a noticeable deterioration in the output print quality (even before *Change Drum Soon* appears), then the drum unit should be replaced. You should clean the machine when you replace the drum unit. (See *Cleaning the laser scanner window* on page 6-18.)

CAUTION

When removing the drum unit, handle it carefully because it contains toner. If toner scatters and your hands or clothes get dirty, immediately wipe or wash with cold water.



Note

The drum unit is a consumable item, and it is necessary to replace it periodically. There are many factors that determine the drum life, such as temperature, humidity, type of paper and how much toner you use for the number of pages per print job. The estimated drum life is *up to* 12,000 pages. The actual number of pages your drum will print may be significantly less than these estimates. Because we have no control over the many factors that determine the actual drum life, we cannot guarantee a minimum number of pages that will be printed by your drum.

WARNING

Just after you have used the machine, some internal parts of the machine are extremely **HOT!** So please be careful.

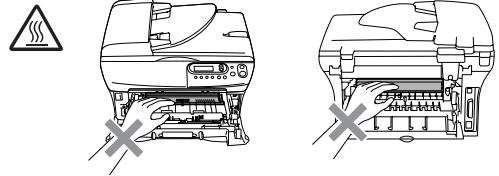

- 1 Open the front cover and pull out the drum unit and toner cartridge assembly.

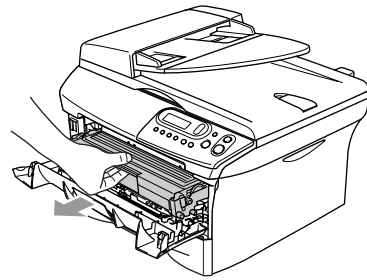

CAUTION

To prevent damage to the printer from static electricity, do not touch the electrodes shown below.

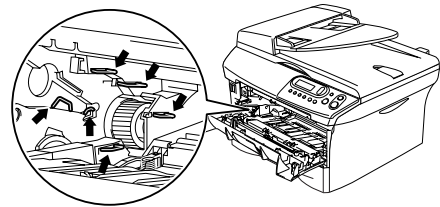

- 2 Hold down the lock lever on the left and pull the toner cartridge out of the drum unit.

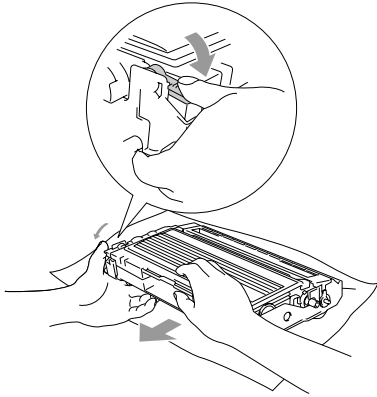

Note

- Discard the used drum unit according to local regulations, keeping it separate from domestic waste. You can also check our ecology website www.brothergreen.co.uk for recycling information. Be sure to seal the drum unit tightly so toner powder does not spill out of the unit. If you have questions, call your local waste disposal office.
- Wait to unpack the new drum unit until immediately before installing it. Place the old drum unit into the plastic bag.

- 3 Reinstall the toner cartridge into the new drum unit. If you put it in properly, the lock lever will lift automatically.

- 4 Install the drum unit and toner cartridge assembly in the machine.

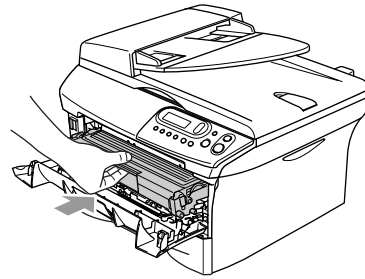

- 5 Press **Options**.





To confirm you are installing a new drum, press ▲.

- 6 When the LCD shows *Accepted*, close the front cover.



Machine Information

Checking the Serial Number

You can view the machine's serial number on the LCD.

- 1 Press **Menu** and  or  to select
3.Machine Info. or
4.Machine Info.

Press **Set**.

- 2 Press  or  to select
1.Serial No.



```
Machine Info.  
1.Serial No.
```

Press **Set**.

- 3 Press **Stop/Exit**.

Checking the Page Counters

You can view the machine's page counters for copies, printer pages, lists and a summary total.

- 1 Press **Menu** and  or  to select
3.Machine Info. or
4.Machine Info.

Press **Set**.

- 2 Press  or  to select
2.Page Counter.

```
Machine Info.  
2.Page Counter
```

Press **Set**.

- 3 Press  or  to select Total,
List, Print or Copy.

Press **Set**.

```
Page Counter  
Total:      XXXXX
```

```
Page Counter  
List:      XXXXX
```



```
Page Counter  
Print:     XXXXX
```

```
Page Counter  
Copy:     XXXXX
```



- 4 Press **Stop/Exit**.

Checking the Drum Life

You can view the machine's drum life on the LCD.

- 1 Press **Menu** and  or  to select
3.Machine Info. or
4.Machine Info.

Press **Set**.

- 2 Press  or  to select
3.Drum Life.

```
Machine Info.  
3.Drum Life
```

Press **Set**.

- 3 Press **Stop/Exit**.

A

Appendix

On-screen programming







Your machine is designed to be easy to use with LCD on-screen programming. User-friendly programming helps you take full advantage of all the menu selections your machine has to offer.

Since your programming is done on the LCD, we have created step-by-step on-screen instructions to help you program your machine. All you need to do is follow the instructions as they guide you through the menu selections and programming options.

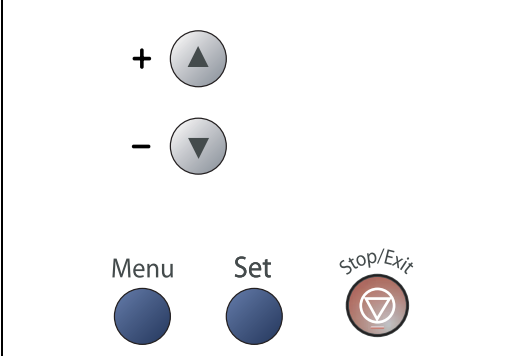

Menu table

The Menu table that begins on page A-3 will help you understand the menu selections and options that are found in the machine's programs. Once you become familiar with programming, you can use the Menu table as a quick reference when you want to change your settings.

Menu Mode

	
	Access the menu
 	Scroll through the current menu level
	Accept an option Go to the next menu level
	Exit the menu

You can access the menu mode by pressing **Menu**.

When you enter the menu, press  or  to scroll through the Main Menu.

Select   & Set
1.General Setup

Select   & Set
2.Copy

⋮

Select   & Set
3.Machine Info.

For DCP-7010L: 3.Machine Info.
For DCP-7025: 4.Machine Info.

You can scroll more quickly through each menu level by pressing the arrow for the direction you want: ▲ or ▼.

Select an option by pressing **Set** when that option appears on the LCD.

The LCD will then show the next menu level.

Press ▲ or ▼ to scroll to your next menu selection.

Press **Set**.

When you finish setting an option, the LCD shows *Accepted*.

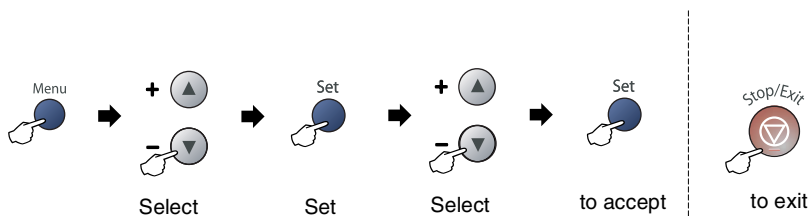

Main Menu	Submenu	Menu Selections	Options	Descriptions	Page	
1. General Setup	1. Paper Type	—	Thin Plain Thick Thicker Transparency Recycled Paper	Sets the type of paper in the paper tray.	2-1	
	2. Paper Size	—	A4 Letter Executive A5 A6 B5 B6	Sets the size of the paper in the paper tray.	2-1	
	3. Beeper	—	High Med Low Off	Adjusts the volume level of the beeper.	2-2	
	4. Ecology	1. Toner Save	—	On Off	Increases the life of the toner cartridge.	2-2
		2. Sleep Time	—	(0-99) 05 Min	Conserves power.	2-3
	5. LCD Contrast	—	Light Dark	Adjusts the contrast of the LCD.	2-3	
	6. User Settings	—	—	You can print a list of your settings.	2-3	
0. Local Language	—	—	Depending on your country	Allows you to change the LCD Language.	6-15	
2. Copy	1. Quality	—	Text Auto Photo	Selects the Copy resolution for your type of document.	3-7	
	2. Contrast	—	▼ -□□□□■+ ▲ ▼ -□□□□□+ ▲ ▼ -□□■□□+ ▲ ▼ -□■□□□+ ▲ ▼ -■□□□□+ ▲	Adjusts the contrast for copies.	3-8	



Note

The factory settings are shown in Bold.

Main Menu	Submenu	Menu Selections	Options	Descriptions	Page
3. Printer (DCP-7025 only)	1. Emulation	—	Auto HP LaserJet BR-Script 3	Selects the emulation mode.	See Software User's Guide on the CD-ROM
	2. Print Options	1. Internal Font	—	Prints a list of the machine's internal fonts or current printer settings.	
		2. Configuration	—		
3. Reset Printer	—	—	—	Returns the PCL settings to the original factory default settings.	
3. Machine Info. (DCP-7010L only)	1. Serial No.	—	—	Lets you check the serial number of your machine.	6-25
	2. Page Counter	—	Total Copy Print List	Lets you check the number of pages the machine has printed during its life.	6-25
	3. Drum Life	—	—	You can check the percentage of drum life that remains available.	6-25
4. Machine Info. (DCP-7025 only)	1. Serial No.	—	—	Lets you check the serial number of your machine.	6-25
	2. Page Counter	—	Total Copy Print List	Lets you check the number of pages the machine has printed during its life.	6-25
	3. Drum Life	—	—	You can check the percentage of drum life that remains available.	6-25

**Note**

The factory settings are shown in **Bold**.

Product description

General

Memory Capacity	16 MB (DCP-7010L) 32 MB (DCP-7025)
Automatic Document Feeder (ADF) (DCP-7025 only)	Up to 35 pages
Paper Tray	250 Sheets (80 g/m ²)
Printer Type	Laser
Print Method	Electrophotography by semiconductor laser beam scanning
LCD (Liquid Crystal Display)	16 characters × 2 lines
Power Source	220 - 240 V 50/60 Hz
Power Consumption	Copying: Average 460 W Sleep: Average 10 W Standby: Average 75 W

Dimensions

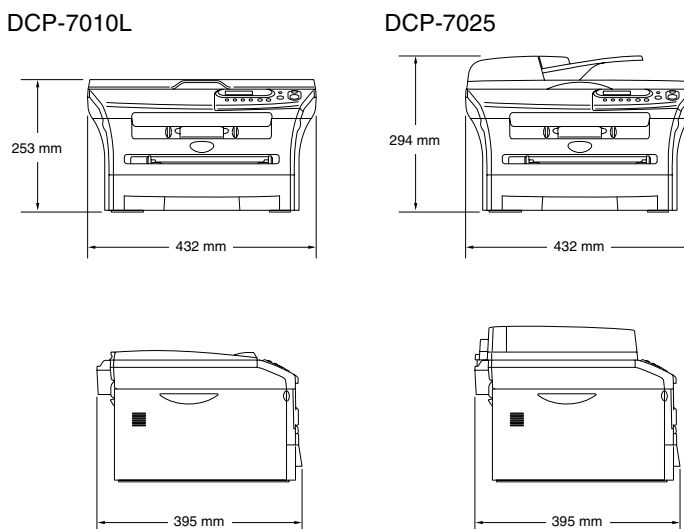

Weight	Without Drum/Toner Unit: 8.3 kg (DCP-7010L) 9.45 kg (DCP-7025)
Noise	Operating: 53 dB A or less Standby: 30 dB A or less

Temperature	Operating:	10 - 32.5°C
	Storage:	0 - 40°C
Humidity	Operating:	20 to 80% (without condensation)
	Storage:	10 to 90% (without condensation)

Print media

Paper Input

Paper Tray

- Paper type:
Plain paper, Recycled paper or Transparencies
- Paper size:
A4, Letter, Executive, A5, A6, B5 and B6
- Paper Weight:
60 - 105 g/m²
- Maximum paper tray capacity:
Up to 250 sheets of 80 g/m² plain paper or
up to 10 transparencies

Manual Feed Slot

- Paper type:
Plain paper, Recycled paper, Transparencies, Envelopes, Bond paper or Labels
- Paper size:
Width: 69.9 - 215.9 mm
Length: 116 - 406.4 mm
- Paper Weight:
60 - 161 g/m²
- Maximum paper tray capacity: One sheet at a time

Paper Output

Up to 100 sheets of A4 size plain paper (Face down print delivery to the output paper tray)



Note

- For transparency or label, we recommend removing printed pages from the output paper tray immediately after they exit the machine to avoid smudging.
- For more details, see *About paper* on page 1-6.

Copy

Color/Monochrome	Monochrome
Document Size	ADF Width: 147.3 mm to 215.9 mm (For DCP-7025 only) ADF Height: 147.3 mm to 356 mm (For DCP-7025 only) Scanner Glass Width: Max. 215.9 mm Scanner Glass Height: Max. 297 mm
Multiple Copies	Stacks up to 99 pages Sorts up to 99 pages (DCP-7025 only)
Enlarge/Reduce	25% to 400% (in increments of 1%)
Resolution	600 x 300 dpi

Scanner

Colour/Monochrome	Colour/Monochrome
TWAIN Compliant	Yes (Windows® 98/98SE/Me/2000 Professional/XP/ Windows NT® Workstation Version 4.0) Mac OS® 9.1 - 9.2/Mac OS® X 10.2.4 or greater
WIA Compliant	Yes (Windows® XP)
Colour Depth	24 bit colour
Resolution	Up to 9600 x 9600 dpi (interpolated)* Up to 600 x 2400 dpi (optical) <small>* Maximum 1200 x 1200 dpi scanning with Windows® XP (resolution up to 9600 x 9600 dpi can be selected by using the Brother scanner utility)</small>
Document Size	ADF Width: 147.3 to 215.9 mm (For DCP-7025 only) ADF Height: 147.3 to 356 mm (For DCP-7025 only) Scanner Glass Width: Max. 215.9 mm Scanner Glass Height: Max. 297 mm
Scanning Width	215.9 mm
Gray Scale	256 levels



Note

Mac OS® X scanning is supported in Mac OS® X 10.2.4 or greater.

Printer

Emulation	Brother Printing System for Windows® PCL6 and BR-Script (PostScript®) Level 3 (DCP-7025 only)
Printer Driver	Support for Windows® 98/98SE/Me/2000 Professional/XP/ Windows NT® Workstation Version 4.0 Support for Mac OS® 9.1 - 9.2/Mac OS® X 10.2.4 or greater
Resolution	HQ1200 (Max. 2400 x 600 dots per inch (dpi))
Print Quality	Normal printing mode Economy printing mode (save toner usage)
Print Speed	up to 20 pages/minute (A4 size) * Based on Brother standard pattern. Does not include the time it takes to feed the paper.
First Print	Less than 10 seconds

Interfaces

Interface	Recommended Cable
Parallel	A bi-directional shielded parallel cable that is IEEE 1284 compliant and no longer than 2.0 m.
USB	A USB 2.0 interface cable that is not longer than 2.0 m.

(Cables are not included.)



Note

Your machine has a full-speed USB 2.0 interface. This interface is compatible with Hi-Speed USB 2.0; however, the maximum data transfer rate will be 12 Mbits/s. The machine can also be connected to a computer that has a USB 1.1 interface.

Please make sure you use a USB 2.0 interface cable that is not longer than 2.0 m.

Computer requirements

Minimum System Requirements						
Computer Platform & Operating System Version		Processor Minimum Speed	Minimum RAM	Recommended RAM	Available Hard Disk Space	
					for Drivers	for Applications
Windows® Operating System	98, 98SE	Pentium® II or equivalent	32 MB	64 MB	90 MB	130 MB
	Me		64 MB	128 MB		
	NT® Workstation 4.0				128 MB	256 MB
	2000 Professional		150 MB	220 MB		
XP ¹						
Apple® Macintosh® Operating System	Mac OS® 9.1 - 9.2 (Printing and Scanning ² Only)	All base models meet minimum Requirements	64 MB	64 MB	80 MB	200 MB
	Mac OS® X 10.2.4 or greater		128 MB	160 MB		

NOTE: All registered trademarks referenced herein are the property of their respective companies.

For the latest drivers, go to the Brother Solutions Center at <http://solutions.brother.com/>

- ¹ Maximum 1200 x 1200 dpi scanning with Windows® XP. (Resolutions up to 9600 x 9600 dpi can be selected using the Brother Utility.)
- ² Dedicated "Scan" key supported in Mac OS® X 10.2.4 or greater.

Consumable items

Toner Cartridge Life

Starter: Up to 1,500 pages*

Standard (TN-2000): Up to 2,500 pages*

*(when printing letter or A4 size paper at 5% print coverage)



Note

Toner life expectancy will vary depending upon the type of average print job.

Drum Unit Life Expectancy (DR-2000)

Up to 12,000 pages



Note

There are many factors that determine the drum life, such as temperature, humidity, type of paper, toner you use and number of pages per print job.

A

- ADF (automatic document feeder) 1-4
- ADF cover 6-3

C

- Cleaning
 - corona wire 6-19
 - drum unit 6-12
 - laser scanner window 6-18
 - scanner glass 6-17
- Consumable items S-5
- Control panel overview 1-3
- Copy
 - contrast 3-3
 - default settings
 - contrast 3-8
 - quality 3-7
 - Enlarge/Reduce key 3-2
 - Number of Copies key 3-1
 - Options key 3-4
 - Page Layout 3-5, 3-7
 - single copy 3-1
 - sort 3-5
 - temporary settings 3-2

D

- Drum Unit
 - cleaning 6-12, 6-19
 - replacing 6-23

E

- Error messages on LCD 6-1
 - No Paper Fed 6-2
 - Out of Memory 3-8, 6-2
 - Unable to Init. 6-2
 - Unable to Print 6-2
 - Unable to Scan 6-2

G

- Gray scale S-3

J

- Jams
 - document 6-3
 - paper 6-3

M

- Maintenance, routine 6-16
- Menu table A-1, A-3

P

- Paper 1-6, S-2
 - size 2-1
 - size of document 1-4
 - type 2-1
- Print
 - difficulties 6-8
 - drivers S-4
 - paper jams 6-4
 - printable area 3-1
 - quality (improving) 6-11
 - resolution S-4
 - specifications S-4
- Programming your machine A-1
 - menu table A-1, A-3

Q

- Quality
 - copy 3-5
 - print 6-11

R

- Resolution
 - copy S-3
 - print S-4
 - scan S-3

S

- Safety instructions iii, 5-2
- Scanner glass (using) 1-5
- Shipping the machine 6-15
- Sleep Time 2-3

T

Temporary copy settings	3-2
Toner cartridge	
replacing	6-20
Toner Save	2-2
Troubleshooting	6-1
document jam	6-3
error messages on LCD	6-1
if you are having difficulty with	
copy quality	6-8
paper handling	6-10
print quality	6-10
printing	6-8
scanning	6-9
paper jam	6-4

U

User Settings	2-3
---------------------	-----

V

Volume (beeper)	2-2
-----------------------	-----

brother[®]