

SAMSUNG

SAMSUNG CAMERA

User Manual

Digital Camera

Digimax 350SE

Thank you for buying a Samsung Camera. This manual will guide you through using the Digimax 350SE, including taking images, downloading images and using MGI PhotoSuite III SE software.
Please read this manual before using your new camera.

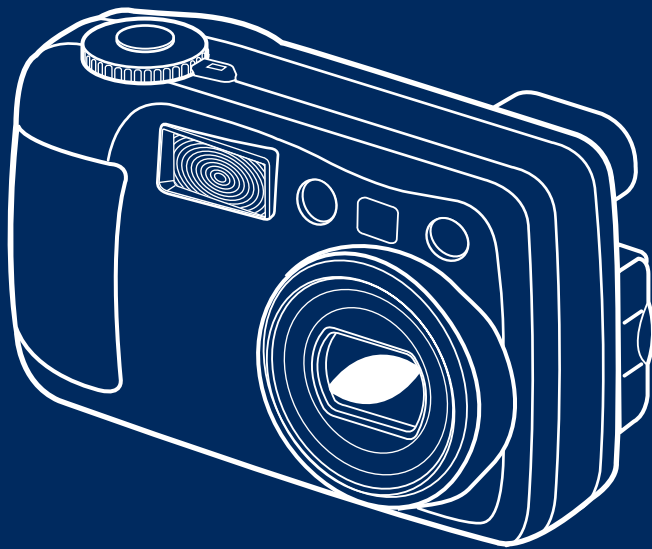

ENGLISH



SPECIAL FEATURES

Thank you for buying a Samsung Digital Camera.
This digital camera has the following features.

- ▶ A high resolution of 3.2 mega pixels
- ▶ A 3 X optical and 2 X digital zoom lens
- ▶ Movie clip and sound recording function
- ▶ An easy and fast PC interface with USB Storage Driver & Digimax viewer
- ▶ Compact size & high class design

A FCC warning

- This device has been tested in accordance with the limits of a class B digital device under item 15 of the FCC rules. These limits are designed to provide protection against harmful interference in commercial installation.

This equipment generates, absorbs and can emit radio frequency energy. If it is not installed and used in accordance with the instructions, it may cause harmful interference to radio communication.

There is however, no guarantee that interference will not occur in a some situations.

Should any interference occur when this device is in operation, please try one or more of the following measures.

- Change the location and direction of any aerial.
 - Increase distance between camera and affected device.
 - Use a different socket away from the affected device.
 - Please contact a Samsung agent or a radio/TV engineer.
- This device complies with part 15 of the FCC Rules.



MANUFACTURER'S CONTENTS

READY

Manufacturer's contents

Please check that you have the correct contents before using this product.

Digital camera



CompactFlash™ card (CF CARD)



4 AA Alkaline Batteries



Pouch



Video cable



USB cable



Camera strap



Applications S/W ,
Driver CD-ROM



User manual



Product warranty



Accessories (optional)



AC Adapter



THIS DIGITAL CAMERA CAN BE USED FOR



Viewing images
on TV

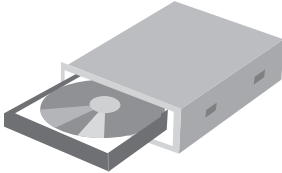

Recording images
onto CD

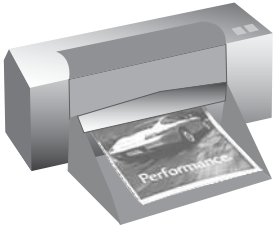

Printing images



Editing images
on a PC



THIS DIGITAL CAMERA CAN BE USED FOR

READY

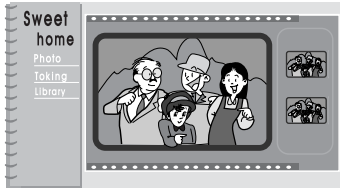

Creation of
a digital photo album



Inserting images
directly into any
electronic document

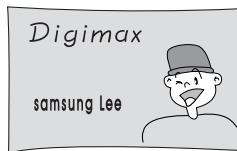

Taking a self-portrait
and using the image
to personalize name
cards

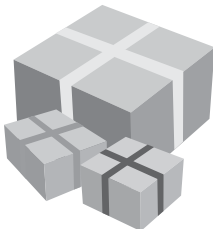

You can even create your
own unique gift-wrap paper
by using your digital
images.



CONTENTS

Ready

- Getting to Know your camera 7
- Safety note 8
- Identification of features 10
 - Product Exterior 10
 - Viewfinder 12
 - LCD monitor indicator 14
 - LCD monitor menu indicator 16
- Preparation 19
 - Connecting to Power 19
 - Using the batteries 19
 - Using the AC power adapter 20
 - Attaching the strap 20
 - Inserting the CF CARD 21
 - Removing the CF CARD 21
 - Instructions on how to use the CF CARD 23
 - Selecting the date and time 24
- Camera working mode 25
- Taking photos 26

Advanced

- Setting up shooting function 29
 - Movie clip shot 29
 - Using the camera buttons
 - to adjust the camera 30
 - Using the LCD monitor
 - to adjust the camera 40
- Setting up play back functions 52
 - Starting play mode 52

- Setting up play function
 - by using the camera button 53
- Setting up play function
 - by using the LCD monitor 59
- Setting up the camera system 67
 - Starting Set up mode 67
- Connecting to an external monitor 78
- PC mode 79
- Important notes 80
 - Caution 80
 - Warning indicator 82
- Before contacting service center 83
- Specification 86

Software

- Software manual 88
- How to set up the softwares for Windows ...89
 - Setting up USB driver for Windows 90
 - Setting up Digimax Viewer 92
 - Setting up the MGI PhotoSuite III SE 94
- Connecting the camera for Windows 97
- Removable Disk 97
- How to use the softwares 100
 - Digimax Viewer 100
 - MGI PhotoSuite III SE 101
- Removing the USB driver for Windows ... 114
- Connecting the camera for MAC 116
- How to install and
 - use the USB driver for MAC 117
- FAQ 118



GETTING TO KNOW YOUR CAMERA

- Prior to using this camera, please read the user manual thoroughly.
- Keep the manual in a safe place.

About the image mark

This manual contains instructions on using this camera that will help you to use this camera safely and correctly. This will help prevent danger and injury to others.



Warning

This is a descriptive statement warning of the result if the instructions are ignored or not understood.



Note

This explains use of the camera, please refer to this.



Reference

This should assist further in the operation of the camera.



SAFETY NOTE



WARNING

- Do not attempt to modify this camera in any way. This may result in fire, injury, electric shock or severe damage to you or your camera. Internal inspection, maintenance and repairs should be carried out by your dealer or Samsung Camera Service Center.
- Do not use the flash in close proximity to the people or animals. Positioning the flash too close to your subject's eyes, may cause eyesight damage. Do not attempt to photograph children using a flash closer than 1 meter proximity.
- When taking photographs, never point the lens of the camera directly into very strong light. This may result in permanent damage to the camera or your eyesight.
- Please do not use this product in close proximity to flammable or explosive gases, as this could increase the risk of explosion.
- For safety reasons keep this product and accessories out of reach of children or animals to prevent accidents e.g.:
 - Swallowing batteries or small camera accessories.
In case of accidents, please consult a doctor immediately.
 - There is a risk of permanent eye damage if the flash is operated at a distance of less than one meter from a person's eyes.
 - There is a possibility of injury from the camera's moving parts.
- Should any form of liquid enter the camera, do not use it. Switch off the camera, and then disconnect the power source (batteries or AC Power Adapter). You must contact your dealer or Samsung Camera Service Center. Do not continue to use the camera as this may cause a fire or electric shock.
- Do not insert or drop metallic or inflammable foreign objects into the camera through access points e.g. CARD slot and battery chamber. This may cause a fire or electric shock.
- Do not operate this camera with wet hands. This could pose a risk of electric shock.



SAFETY NOTE



NOTE

- Do not leave this camera in places subject to extremely high temperatures, such as a sealed vehicle, direct sunlight or other places of extreme variances in temperature. Exposure to extreme temperatures may adversely affect the camera's internal components and could cause a fire.
- When in use, do not cover the camera or AC Power Adapter. This may cause heat to build up and distort the camera case or cause a fire.
- Always use the camera and its accessories in a well-ventilated area. Leakage, overheating, or burst batteries could result in fire or injury. Do not short circuit, heat or dispose of batteries in fire. Do not use old batteries with new ones, or mix brands of batteries. Ensure the batteries are positioned correctly with regard to polarity (+ / -).
- When the camera is not in use for long periods, always unplug the camera from its power source (batteries or AC Power Adapter) for safety purposes. Leaking batteries can cause fire and pollution to the environment.
- Allowing dust to accumulate in the camera over a long period is hazardous as extreme circumstances may cause a fire. It is best to clean your camera prior to seasonal periods of high humidity. Consult your dealer or Samsung Camera Service Center for information on the cost of cleaning your camera.
- Do not move the camera while it is switched on, if you are using the AC Power Adapter. After use, always switch off the camera before unplugging the adapter from the AC Power wall socket. Then make sure that any connector cords or cables to other devices are disconnected before moving the camera. Failure to do so may damage the cords or cables and cause a fire or electric shock.



IDENTIFICATION OF FEATURES

Product Exterior (Front / Top / Bottom)

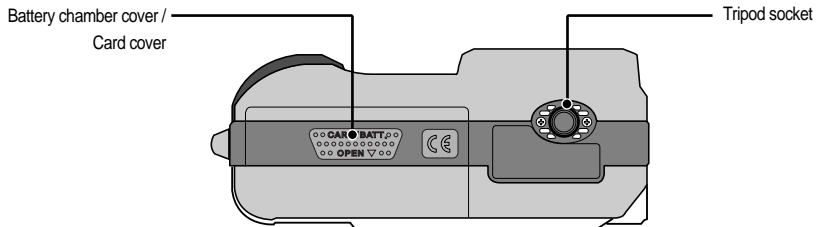
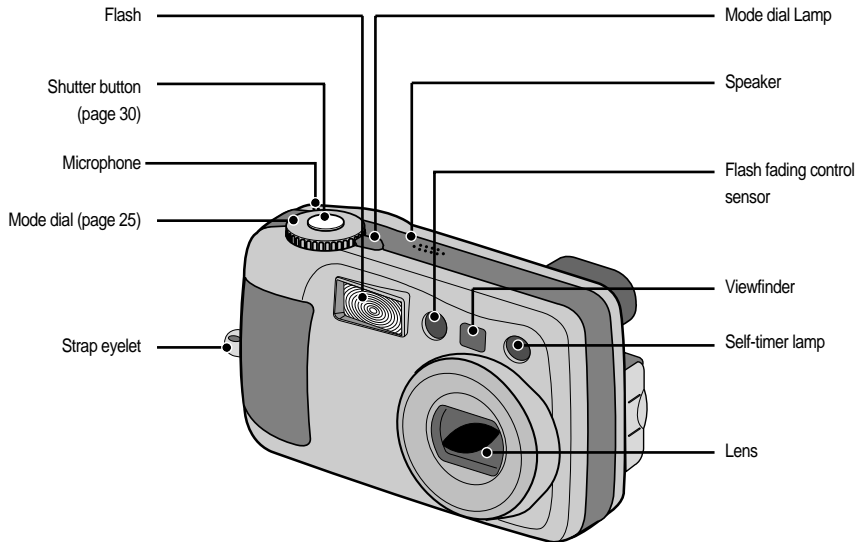



IDENTIFICATION OF FEATURES

Product Exterior (Back)

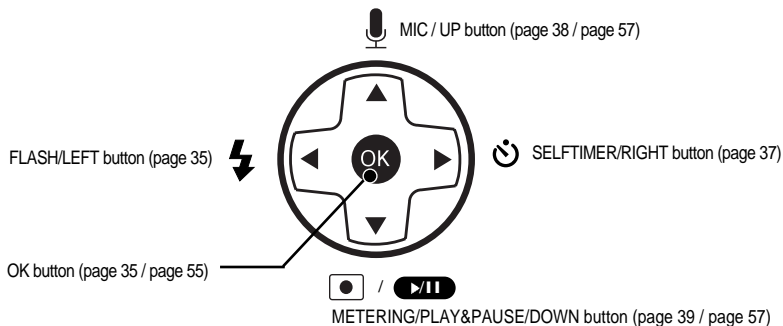
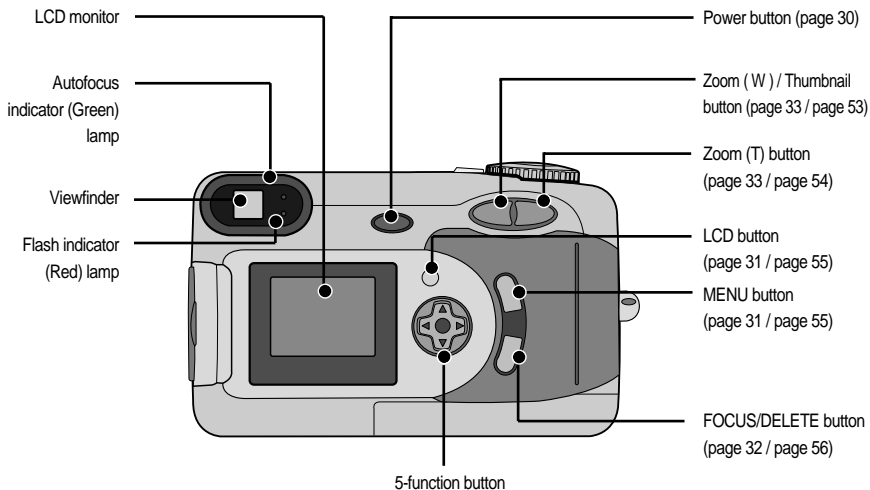



IDENTIFICATION OF FEATURES

Product Exterior (side)

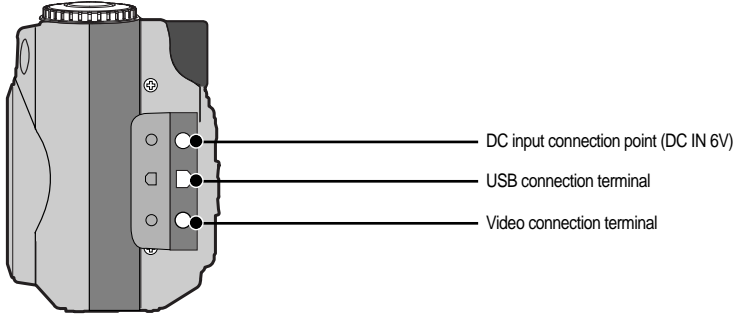

Viewfinder

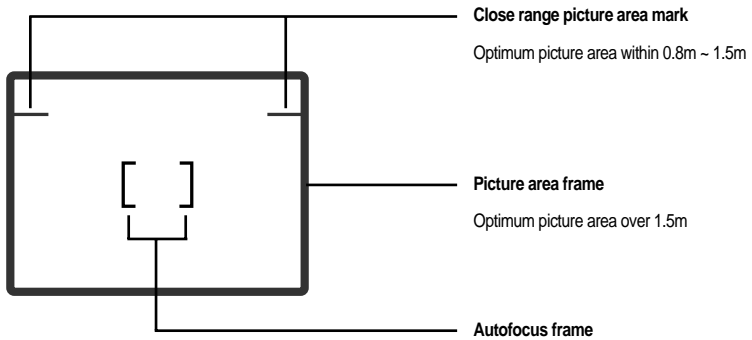



IDENTIFICATION OF FEATURES



Reference

- Vertical and Horizontal shots are taken in the same way.
- Avoid obstructing the lens or the flash when you take a picture.



[Horizontal grip]



[Vertical grip]



Note

- As there can be some differences between what is seen through the Viewfinder and the resulting image when taken at a range closer than 1.5m, it is recommended that you use the LCD monitor to compose the shot.



IDENTIFICATION OF FEATURES

LCD monitor indicator

The LCD monitor displays information about the shooting conditions.

■ Shot mode

Whenever you press the LCD button, the LCD monitor will change in the following order :
Image & Status → Image only → LCD Off.

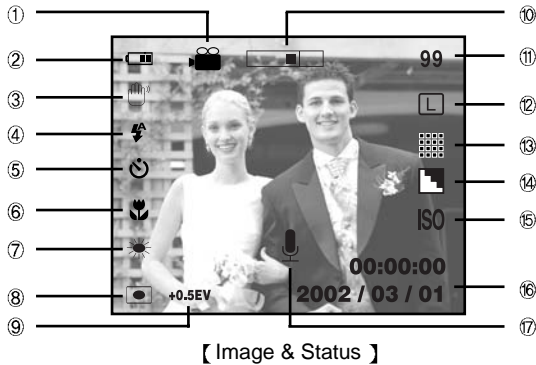

1	Shot mode indicators		
2	Battery indicator		page 19
3	Camera shake warning		page 28
4	Flash		page 35
5	Self timer		page 37
6	Macro / Fixed focus		page 32
7	White Balance		page 50
8	Metering methods		page 39



IDENTIFICATION OF FEATURES

9	Exposure compensation	+0.5EV	page 47
10	Zoom / Digital Zoom		page 33
11	Number of available shots remaining	9999	
12	Image size / Continuous shot		page 41/45
13	Image quality		page 42
14	Sharpness		page 43
15	ISO	ISO	page 49
16	Date / Time	2002 / 03 / 01 00:00:00	page 24
17	Sound recording		page 38

■ Play mode

Whenever you press the LCD button, the LCD monitor will change in the following order :
Image → Image & Status

Battery condition indicator
The battery level indicator is shown in the top left corner of the LCD monitor.

Movie clip shot indicator
The movie clip shot indicator is shown in the top left corner of the LCD monitor.

Sound recorded indicator
This indicator will display when a sound recorded still image plays back.

PROTECT indicator (page 60)
This indicator will display when you set PROTECT.

DPOF indicator (page 64)
This indicator will display when you set STANDARD DPOF.

Stored image number
The last stored image number is displayed.

Image information (page 55)
The image information is displayed in the center of the LCD monitor.

Sound recording indicator (page 57)
When you press the MIC button, this indicator will display that a sound signal has been recorded. This sound recording is linked to the image that has been taken.

Date / Time indicator
This indicator will display when you set Imprint.

[Image & Status]



IDENTIFICATION OF FEATURES

LCD monitor menu indicator

■ Each mode has a menu as shown below. The default settings in each mode are printed below.

【 STILL IMAGE mode 】

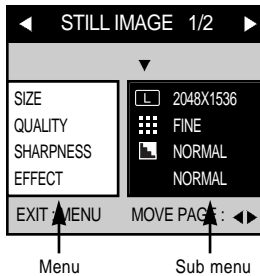

- SIZE : select image size (page 41)
- QUALITY : select image quality (page 42)
- SHARPNESS : select image sharpness (page 43)
- EFFECT : add effect to image (page 44)

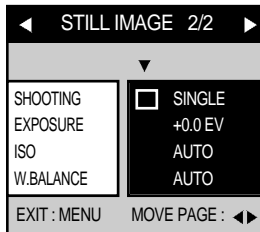

- SHOOTING : select shot mode (Single / Continuous) (page 45)
- EXPOSURE : select E.V. (page 47)
- ISO : select ISO (page 49)
- W.BALANCE : select White Balance (page 50)

【 NIGHT SCENE mode 】



- SIZE : select image size (page 41)
- QUALITY : select image quality (page 42)
- SCENE : select night shot mode (page 51)



IDENTIFICATION OF FEATURES

【 MOVIE CLIP mode 】

MOVIE CLIP	
EXPOSURE	+0.0 EV
ISO	AUTO
W. BALANCE	AUTO
EFFECT	NORMAL
EXIT : MENU	

- EXPOSURE : select E.V. (page 47)
- ISO : select ISO (page 49)
- W.BALANCE : select White Balance (page 50)
- EFFECT : add effect to image (page 44)

【 PLAY mode 】

PLAY 1/2	
SLIDE SHOW	03 SEC
PROTECT	UNLOCK
DELETE ALL	NO
FORMAT	NO
EXIT : MENU MOVE PAGE : ◀▶	

- SLIDE SHOW : play back stored images continuously (page 59)
- PROTECT : protect stored image (page 60)
- DELETE ALL : delete all stored images (page 62)
- FORMAT : format CF CARD (page 63)

PLAY [DPOF] 2/2	
STANDARD	00 PRINTS
INDEX	00 PRINTS
CANCEL	NO
REVIEW	S[00] / I[00]
EXIT : MENU MOVE PAGE : ◀▶	

- STANDARD : set DPOF as STANDARD (page 64)
- INDEX : set DPOF as INDEX (page 65)
- CANCEL : cancel DPOF setting (page 66)
- REVIEW : review DPOF setting (page 66)



IDENTIFICATION OF FEATURES

[SET UP mode]

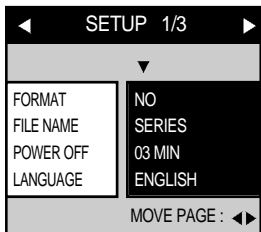

- **FORMAT** : format CF CARD (page 67)
- **FILE NAME** : input file name (page 67)
- **POWER OFF** : set up auto power off (page 69)
- **LANGUAGE** : select language (page 69)

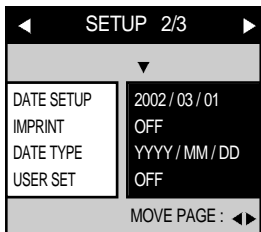

- **DATE SETUP** : select Date / Time (page 70)
- **IMPRINT** : print Date / Time on stored image (page 71)
- **DATE TYPE** : select Date / Time type (page 72)
- **USER SET** : set the camera to the user's preferences (page 73)

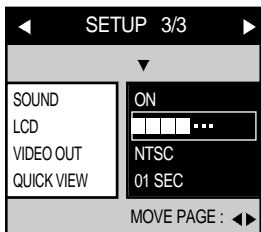

- **SOUND** : select SOUND (page 76)
- **LCD** : select LCD brightness (page 76)
- **VIDEO OUT** : select VIDEO OUT type (page 77)
- **QUICK VIEW** : view a stored image for a short time (page 77)



Reference

- There is no associated menu in PC mode and the LCD monitor is always turned off in PC mode.



PREPARATION

Connecting to Power

There are two ways in which to provide the camera with power. You can use batteries (AA Alkaline or CR-V3), or alternatively, you can use an AC Adapter (DC 6V / 2.0A).

■ Using the batteries

- 1 Open the battery chamber cover by pushing in the direction of the arrow.
- 2 Insert the batteries taking note of the polarity (+ / -).
- 3 To close the battery chamber cover, push it until it clicks.

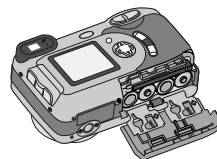

Reference

- This camera will automatically switch off when not in use for a period of time.
- We recommend high-capacity ALKALINE batteries (2000mAh) as manganese batteries cannot deliver sufficient power.



Note

▶ Important information about battery usage

- Please remove the batteries if the camera will not be used for long periods. Batteries can lose power over time and are prone to leaking if kept inside the camera.
- Low temperatures (below 0°C) can affect the performance of the batteries and you may experience reduced battery life.
- Batteries will normally recover at normal temperatures.
- Do not use old and new batteries at the same time.
- During extended use of the camera, the camera body may become warm. This is perfectly normal. If you are planning to use this camera for long periods of time, it is advisable to use an AC adapter.

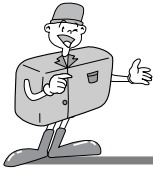

PREPARATION

■ Using the AC power adapter

- If you have access to a mains supply, using an AC Adapter allows the camera to be used for long periods of time. If you connect the camera to a computer, it is advisable to use an AC adapter, as this will enable extended use.
- Plug the adapter into the connection point (DC IN 6V) on the camera.
Please ensure that you use an AC adapter with the correct specification for the camera (6v /2.0A).
Failure to do so may affect your warranty.

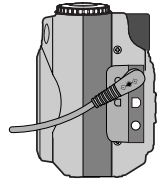

WARNING

- Always turn off the power before taking the AC adapter out of the mains supply.
- As with all mains powered devices, safety is important. Ensure that neither the camera nor adapter comes into contact with water or metallic materials.

Attaching the strap

- To prevent accidental damage to the camera, always use the strap.
- Refer to the illustrations below

1

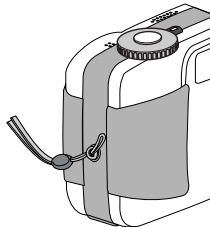

2

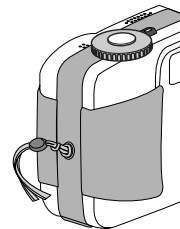



PREPARATION

Inserting the CF CARD

- 1 Pull the card cover in the direction of the arrow to open.
- 2 Insert the card towards the arrow. The front side of the CF CARD (printed arrow) and the front side of the camera should face in the same direction when the card is inserted.
- 3 To close, push the card cover against the arrow until you hear a click.

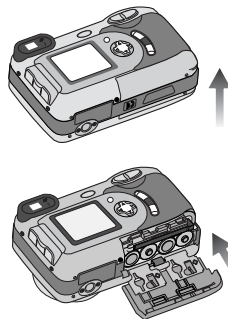

Removing the CF CARD

- 1 Turn the power off using the power button (①).
- 2 Push the Card eject lever (②) down.
- 3 Remove CF CARD as shown in the image.

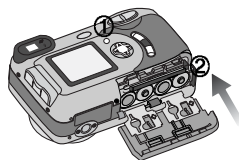

※ CompactFlash™ card is the registered trademark of Sandisk.



Note

- Repeated use of a CF CARD will eventually reduce the card's performance. Should this be the case, you will need to purchase a new CF CARD. Wear and tear on the card is not covered by the Samsung warranty.
- If you open the card cover when the camera power is turned on, the power will turn off automatically.



PREPARATION



Reference

- Using a 16/ 32MB CF CARD, the specified shooting capacity will be as follows.
(These figures are intended as an indication of expected performance)

Recorded image size	Recorded image quality	Number of shots	
		16MB	32MB
2048 x 1536 (Large)	Super Fine	9	19
	Fine	19	39
	Normal	29	59
2048 x 1360 (Photo)	Super Fine	10	22
	Fine	22	45
	Normal	32	66
1024 x 768 (Medium)	Super Fine	38	77
	Fine	75	153
	Normal	110	225
512 x 384 (Small)	Super Fine	163	333
	Fine	269	547
	Normal	377	767

- ※ These figures are approximate as image capacities can be affected by variables such as card performance and subject matter.



PREPARATION

Instructions on how to use the CF CARD

■ Using a new CF CARD for the first time

- Before using the CF CARD, it must be initialized.
- Initializing prepares the CF CARD for recording data.
- For more details, please refer to page 67

■ Preserving the CF CARD data

- If the card is subjected to any of the following, the recorded data may become corrupted :
 - When the CF CARD is used incorrectly.
 - If the power is switched off while recording, deleting(formatting) or reading.
- It is advisable to copy important data onto other media as back-up e.g. floppy disks, hard disks, CD etc.
- Samsung cannot be held responsible for lost data.

■ Important information on the use of the CF CARD

- If you switch off this camera while it is reading, initializing or playing, the information on the CF CARD may be corrupted.
- The CF CARD is an electronic precision device. Do not bend, drop or subject the card to any heavy impact.
- Do not store the CF CARD in an environment with strong electronic or magnetic fields, e.g. near loud speakers or TV receivers.
- Please do not use or store in an environment where there are extremes of temperature.
- Do not allow the CF CARD to become dirty or to come into contact with any liquid. Should this happen, clean the card with a soft cloth.
- Please keep the CF CARD in its case when not in use.
- During and after periods of extended use, you may notice that the CF CARD is warm. This is perfectly normal.



PREPARATION

Selecting the date and time

- You can record the date and time with the image data in the CF CARD when you take an image.
You will need to check and select the correct Date / Time when :
The camera is used for the first time.
The batteries have been removed for a period longer than 1 hour.

1 Turn on the power by pressing the Power button.

2 Set the mode dial to the SETUP mode (SET).

3 The setup menu will show on the LCD monitor.

4 Move to the 「SETUP 2/3」 menu by using the RIGHT button(▶) on the 5-function button.

5 Move to the 「DATE SETUP」 by using the DOWN button(▼) on the 5-function button and press the RIGHT button(▶).
A menu will then be displayed on the LCD monitor as shown alongside.

6 Select correct Date / Time by using the 5-function button and press the OK button to update Date / Time. 「SETUP 2/3」 menu will be displayed on the LCD monitor.

7 The setting is completed. The camera can now be used with the selected camera mode.

【 5-function button 】

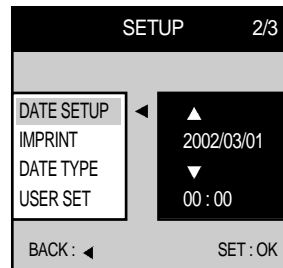

Reference

- The selection range for date/time setup covers from 2001~2050.(It is automatically programmed to allow for a leap year/ month)
- It is originally set as [2002/03/01 00:00]



CAMERA WORKING MODE

Camera working mode

- You can select the desired working mode by using the mode dial located on the top of the camera.

This digital camera has 6 working modes. These are listed below

- ▶ STILL IMAGE mode ()

This mode is used for macro shots between 0.2m ~ 0.8m, normal images from 0.8 ~ infinity and taking a moving subject continuously.

- ▶ NIGHT SCENE mode ()

This mode is used at night or against a dark background. In this mode you can select [LANDSCAPE] for scenery or [PORTRAIT] for both scenery and portrait.

- ▶ MOVIE CLIP mode ()

This mode is used for movie clips.

The flash is changed to FLASH OFF when this mode is selected.

- ▶ PLAY mode ()

In this mode, the stored images on the CF CARD can be viewed on the LCD monitor on the back of the camera or on an external monitor using a video output terminal.

If you view a shot which has additional sound recording, the sound will play back whilst the image is viewed. You can select single image play back, 9 thumbnail screen, slide show, image protection, all image deletion or CF CARD formatting in this mode.

- ▶ PC mode ()

Your computer will recognize the camera as a Removable Disk when connected by the USB cable. You can transfer images between the computer and the camera.

- ▶ SETUP mode ()

In this mode, you can set up basic settings such as sound, format, auto power off, date / time, LCD brightness.

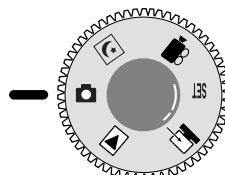

[Mode dial information]



TAKING PHOTOS

Now let's take a picture

- 1 To switch on the camera, press the POWER button (①).

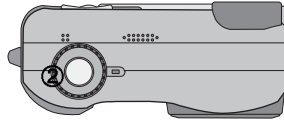
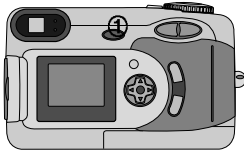

Pressing the power button over 2 seconds changes the SOUND setting to OFF, though you have set the setting to ON.

If you wish to hear the buzzer sound, set the setting to ON.

- 2 Select the desired mode (Still image / Night scene/ Movie clip) according to the image range or subject by using the mode dial (②) on the top of the camera.
Macro and Continuous shooting are available in STILL IMAGE mode.

- 3 Change the menu by using the camera buttons and LCD monitor and select the appropriate settings (image quality, image size etc.).
Refer to pages 29 – 77 for information on camera setting.

- 4 Decide the image composition that you want to achieve by using the optical viewfinder or the LCD monitor.

- 5 When taking images, squeeze the shutter button gently to avoid camera shake.
 - Pressing the shutter button down halfway activates the autofocus and checks the condition of the flash.
 - Pressing the shutter button down halfway activates the autofocus. After selecting the focus, the Green lamp will light up.
To prevent camera shake, press the Shutter button gently as the autofocus might be changed by camera shake.
With lighting up the Green lamp, pressing the shutter down fully takes the image and stores the relevant data regarding the shot.



TAKING PHOTOS



Note

- Select Macro shot mode when the subject is between 0.2m ~ 0.8m from the camera. Refer to page 32 for information on Macro shooting.
- If you take an image in dark place " LOW LUMINANCE" message will display on the LCD monitor. In addition, it may cause the camera to fix the focus as listed below.
Normal shot mode : 2.5M Macro shot mode : 0.5M
In this case, increase the lighting value or take an image in a bright place.
- If you do not select the correct shot mode appropriate to the distance from the subject to the camera, you will not be able to obtain a clear shot of the subject.
- Avoid obstructing the Flash control sensor when you take an image. An image can be spoiled when a finger, hair or camera strap is in front of the Flash control sensor.
- Using the LCD monitor extensively will drain the batteries. We recommend using the optical viewfinder as often as possible in order to extend battery life. If the LCD monitor is more appropriate, switching it off between shots will also help to extend the battery life.



Reference

- ▶ If there is no card, [NO CARD!] message will show in the LCD monitor.
- ▶ If there is no card, no buttons will function except for Power button, Mode dial and Zoom button.
- ▶ If there is insufficient memory available:
 - If you press the shutter button halfway for the shot, the following message is displayed and the camera will not operate.

CARD FULL !

- * To optimise the amount of memory in the camera, replace the CF CARD or delete unnecessary images stored on the CF CARD.



TAKING PHOTOS



Reference

- ▶ There are two LED lamps (one green, one red) positioned next to the viewfinder.
 - If the camera is in focus when you press the shutter button halfway, the green LED will light up and you can take an image.
 - If the red lamp lights up, the flash can fire.
 - If the red lamp blinks, the flash is being charged.
 - When an image is being stored onto the CF CARD, the green lamp blinks slowly. When the image data has been stored, the green LED light will go out. After the green LED light has gone out, you can resume taking images.



Note

- ▶ Under certain conditions the auto focus system may not perform as expected.
 - When photographing a subject that has little contrast.
 - If the subject is highly reflective or shiny.
 - If the subject is moving at high speed.
 - When the subject matter has only horizontal lines or the subject is very narrow (such as a stick or flagpole).
 - When there is strong reflected light, or when the background is very bright.
- ▶ Camera shake warning.
 - When the Flash Off mode is selected, the camera shake warning indicator () may appear on the LCD monitor. In this case, use a tripod, support the camera on a solid surface or change the flash mode to flash shot mode.
- ▶ Backlight compensated shot
 - When taking an outdoor shot, avoid facing the sun, as the image may be dark because of backlight. In backlight conditions, please use the exposure compensation (refer to page 47). Alternatively, press the METERING button after the LCD monitor comes on, and the exposure will be adjusted accordingly.



SETTING UP SHOOTING FUNCTION

Movie clip shot

- In a movie clip shot, sound and movie clip are recorded at the same time.
- When the mode dial is rotated to MOVIE CLIP mode, the LCD monitor will be displayed as shown below.



Available recording time.
(e.g. : 24sec)

- Press the shutter button once and movie clips are recorded for as long as the available recording time allows.
Movie clips will still be recorded if the shutter button is released.
- If you wish to stop recording, press the shutter button again.
- The self-timer lamp (red) on the front of the camera will illuminate during the recording.
- Image size and type are listed below.
 - Image size : QVGA (320 x 240)
 - File type : *.AVI
- When the movie clip is being recorded to the CF CARD, the Green lamp blinks.
[Please Wait] message will be displayed on the LCD monitor.

ADVANCED



Note

- Don't remove the batteries during the movie clip shot as it makes the movie clip file size decrease.



SETTING UP THE SHOOTING FUNCTION

Using the camera button to adjust the camera

- Still image, Night scene and Movie clip can be set up using the camera button.

POWER button

- Used for turning the camera power on / off.
- The camera power will be turned off automatically during periods of inactivity. This is done to reduce battery drain. The camera can be reactivated by pressing the power button again.

SHUTTER button

- Used for taking images in shot mode (Still image, Night scene, Movie clip).
 - Pressing the shutter button down halfway activates the autofocus and checks the condition of the flash. Note that releasing the button will de-select the autofocus and the camera will re focus when the button is depressed for the second time
- Pressing the shutter down fully takes the image and stores the relevant data regarding the shot.



SETTING UP THE SHOOTING FUNCTION

LCD button

- Pressing the LCD button in the shot(STILL IMAGE, NIGHT SCENE, MOVIE CLIP) mode will change the display as shown below.
- If the LCD monitor is turned off, the mode dial lamp is turned on at the same time.



MENU button

- When you press the MENU button, a menu related to each camera mode will be displayed on the LCD monitor. Pressing it again will return the LCD to the initial display.
 - A menu option can be displayed when the following are selected : STILL IMAGE mode, NIGHT SCENE mode, MOVIE CLIP mode, PLAY mode and SETUP mode.
- There is no menu available when PC mode is selected.



SETTING UP THE SHOOTING FUNCTION

FOCUS button



- Used for macro shots (0.2M ~ 0.8M).
- In dark conditions, the autofocus may not function. If this occurs, press the FOCUS button and you can select fixed focus manually.

1. Turn the camera power on.
2. Rotate the mode dial to the shot mode (Still image, Night scene, Movie clip).
3. Do not turn the LCD monitor off.
4. Press the FOCUS button until the desired FOCUS mode indicator displays on the LCD monitor. Setting up the focus is explained below.
5. Take a picture.

■ Focus setting

- ▶ [Auto focus mode] : Pressing the FOCUS mode will change the focus mode. See below :

Auto focus mode(No indicator) ↔ Macro ()

- ▶ [Fixed focus mode] : Holding the FOCUS button down over two seconds will select Fixed focus and () indicator will be displayed on the LCD monitor. () indicator is changed as shown below by pressing the FOCUS button.

 → 2.5 M → 1.0 M

- ▶ Pressing the FOCUS button over two seconds again, the focus mode is changed to [Auto focus mode].





< Selecting Macro >



< Selecting 2.5M >



Reference

- The default of the FOCUS mode is Auto focus mode. If the LANDSCAPE in NIGHT SCENE mode is selected, the camera will default to  (infinity).
- The selected FOCUS mode is maintained until the camera power is switched off. However, if the LANDSCAPE in NIGHT SCENE mode is selected, the camera will default to  (infinity).
- We recommend the use of a tripod when using the camera in MACRO
- Do not use the optical viewfinder when MACRO is used.



SETTING UP THE SHOOTING FUNCTION

ZOOM (W/T) button

- Used for digital or optical zooming in / out (Still image, Night scene, Movie clip).
- This camera has a 3X optical zoom and a 2 X digital zoom function. Using both will offer a total zoom ratio of 6 X.
- When you press the zoom (W/T) button, the zoom bar will display in the upper centre of the LCD monitor.

■ Optical zoom

1. Zoom TELE

Press zoom button T.

This will zoom into the subject i.e. the subject will appear nearer.

2. Zoom WIDE

Press zoom button W.

This will zoom out from the subject i.e. the subject will appear further away. Pressing the W button continuously will set the camera to its minimum zoom setting i.e. the subject appears at its furthest from the camera.

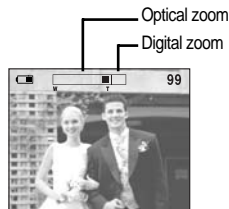

■ Digital zoom

- To use digital zoom the LCD monitor has to be turned on.
- The digital zoom will operate only when the optical zoom is at its maximum i.e. when the subject appears to be at its closest. Pressing the T button will operate the digital zoom in steps; 1.5 X and 2.0 X.

1. Digital TELE

- When the maximum (3 X) optical zoom is selected, pressing the zoom button T activates the digital zoom software.
- Releasing zoom button T stops the digital zooming at the required setting.
- Once the maximum digital zoom (2 X) is achieved, pressing the zoom button T will have no effect.

2. Digital WIDE

- When the digital zoom is in operation, pressing the zoom button W will reduce the digital zooming in steps.
- Releasing zoom button W stops the digital zooming.
- Pressing the W button will reduce the digital zoom and then it will proceed to reduce the optical zoom until the minimum setting is reached or the button is released.



SETTING UP THE SHOOTING FUNCTION



Reference

- Images taken using the digital zoom may take a little longer for the camera to process. Allow time for this to take place (the green viewfinder LED will indicate when the operation is complete).
- The digital zoom cannot be used in continuous shots or movie clip shots.
- You may notice a decrease in image quality when using digital zoom.



Note

- Take care not to touch the lens during the zoom operation as this may cause damage.
- Take care not to touch the lens to avoid taking a dim image and camera malfunction.
- When the camera is turned on, take care not to touch the camera moving parts of lens as this may make the image be dim.
- Take care not to touch the lens during the zoom operation as this may make the image be dim.
- If the image is dim, turn the camera power off and turn on again to modify the lens position.



SETTING UP THE SHOOTING FUNCTION

OK button

- Used as a confirming data that is changed by using ▲/▼/◀/▶ buttons.

FLASH / LEFT button

- When the menu is displayed on the LCD monitor, pressing the ◀ button makes the cursor shift to the left or to the main menu.
 - When the menu is not displayed on the LCD monitor, the ◀ button operates as the FLASH button.
 - Use the correct flash to suit the environment.
1. Turn the camera power on.
 2. Rotate the mode dial to the STILL IMAGE mode or NIGHT SCENE mode.
 3. Do not turn the LCD monitor off.
 4. Press the FLASH button until the desired FLASH mode indicator displays on the LCD monitor.
 5. Take a picture.



< Selecting Auto flash >

ADVANCED



Note

- Photograph within the flash range. The flash ranges are listed below

	ISO	W	T
Normal	AUTO	0.8 ~ 3m	0.8 ~ 2m
	100	0.8 ~ 3m	0.8 ~ 2m
	200	1.6 ~ 4m	1.6 ~ 3m
	400	2 ~ 4.6m	2 ~ 3.6m
Macro	AUTO	0.2 ~ 0.8m	0.2 ~ 0.8m
	100	0.2 ~ 0.8m	0.2 ~ 0.8m
	200	0.4 ~ 0.8m	0.4 ~ 0.8m
	400	0.6 ~ 0.8m	0.6 ~ 0.8m

- The image quality is not guaranteed if the subject is too close or highly reflective.



SETTING UP THE SHOOTING FUNCTION

■ Flash mode indicator

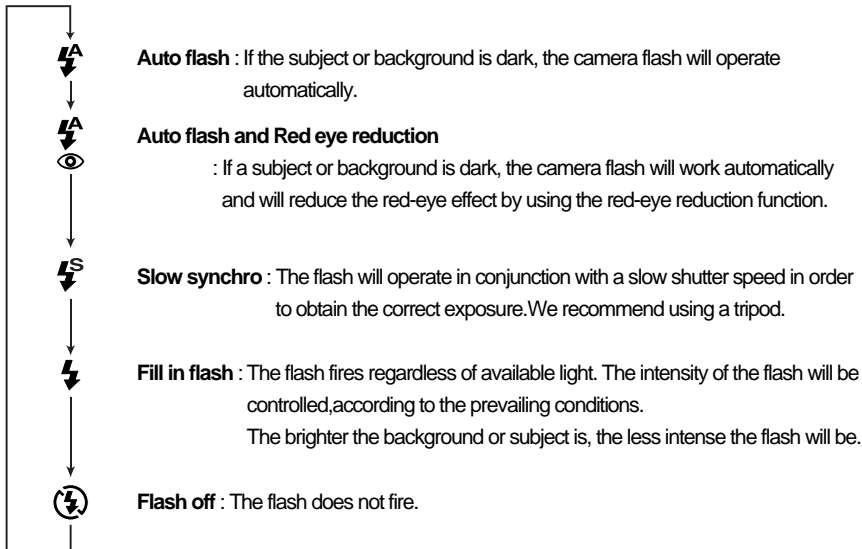

Reference

- Using the flash frequently will reduce the life of the batteries.
- Under normal operating conditions the charging time for the flash is normally within 7 seconds. If the batteries are weak, the charging time will be longer.
- The default of each mode is listed below.
 - STILL IMAGE mode : AUTO
 - NIGHT SCENE mode : PORTRAIT - Auto flash and Red eye reduction
LANDSCAPE - FLASH OFF
 - MOVIE CLIP mode : FLASH OFF (fixed).



SETTING UP THE SHOOTING FUNCTION

SELF-TIMER / RIGHT button

- When the menu is displayed on the LCD monitor, pressing the ► button makes the cursor shift to the sub menu.
 - When the menu is not displayed on the LCD monitor, the ► button operates as the SELF TIMER button.
 - This function is used when the photographer would also like to be in the image.
1. Turn the camera power on.
 2. Rotate the mode dial to the shot mode (Still image, Night scene, Movie clip).
 3. Do not turn the LCD monitor off.
 4. If the self-timer indicator is displayed on the LCD monitor by pressing the SELF TIMER button, the setting is completed.
 5. Pressing the shutter button will allow an interval of ten seconds before the image is taken.
After that, the self-timer is canceled.



< Selecting Self Timer >

ADVANCED



Reference

- The default is OFF
- The self-timer LED lamp (red) and Self timer indicator on the LCD monitor will blink for 10 seconds after the SELF-TIMER button has been pressed.
 - For the first seven seconds, the LED blinks at one second intervals
 - For the final three seconds, the LED blinks quickly at 0.5-second intervals.
- If you operate the Power button, Mode dial, and Self-timer button during the self-timer operation, the self-timer function is cancelled.



SETTING UP THE SHOOTING FUNCTION

MIC / UP button

- When the menu is displayed on the LCD monitor, pressing the ▲ button makes the cursor shift to up, or changes the sub menu.
- When the menu is not displayed on the LCD monitor, the ▲ button operates as the MIC (sound recording) button.

■ STILL IMAGE/ NIGHT SCENE mode

1. Turn the camera power on.
2. Rotate the mode dial to the STILL IMAGE mode or NIGHT SCENE mode.
3. Do not turn the LCD monitor off.
4. If the MIC indicator is displayed on the LCD monitor when pressing the MIC button, the camera is ready for recording sound.
5. Sound will be recorded for ten seconds from the moment the shutter button is pressed. [RECORDING] is displayed during the recording as shown beside.
6. In the middle of the sound recording, pressing the shutter button will stop the sound recording.

When you press the shutter button to stop the sound

recording, press the shutter button halfway and the buzzer sound will not be recorded.



< Setting up sound recording >



< Being recorded >



Reference

- 40cm between you and the camera(microphone) is the best distance to record a sound.
- The setting is not changed until the mode dial is rotated or the power is turned off.
- To cancel the sound recording function, press the MIC button again.

■ MOVIE CLIP mode

- In MOVIE CLIP mode, sound is recorded automatically.
There is no need to set up the sound recording function.



SETTING UP THE SHOOTING FUNCTION

METERING / Down button

- When the menu is displayed on the LCD monitor, pressing the ▼ button makes the cursor shift to down or changes the sub menu.
- When the menu is not displayed on the LCD monitor, the ▼ button operates as the METERING button.
- This button can be used to obtain the right exposure.

1. Turn the camera power on.
2. Rotate the mode dial to the shot mode.
(Still image, Night scene, Movie clip).
3. Do not turn the LCD monitor off.
4. If the desired metering mode indicator is displayed on the LCD monitor when pressing the METERING button, the function is ready for recording.
5. Take a picture.



< Selecting CENTER metering >

■ METERING mode indicator

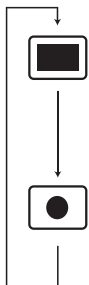

- Center Weighted Average metering :
Exposure will be calculated based on an average of the light available in the image area. However, the calculation will be biased towards the centre of the image area
- CENTER metering :
Use this function when there is backlight or when photographing a subject that has little contrast. In backlighting conditions adjust the light metering to suit the subject matter.



Reference

- The default of the metering mode is Center Weighted Average metering
- Adjustments to the metering will not change until the camera is switched off.



SETTING UP THE SHOOTING FUNCTION

Using the LCD monitor to adjust the camera

- Shooting functions can be changed by using the LCD monitor.
- In the shot mode, pressing the MENU button displays the menu on the LCD monitor.
- The following functions are available, depending on the mode you have selected (Still image, Night scene, Movie clip).

	STILL IMAGE mode	NIGHT SCENE mode	MOVIE CLIP mode
SIZE	○	○	X
QUALITY	○	○	X
SHARPNESS	○	X	X
EFFECT	○	X	○
SHOOTING	○	X	X
EXPOSURE	○	X	○
ISO	○	X	○
W.BLANCE	○	X	○
SCENE	X	○	X



Reference

- ▶ The menu will not be displayed on the LCD monitor under the following conditions:
 - When another button is being operated.
 - While image data is being processed. (when the green LED next to the viewfinder flashes)
 - When there is no battery capacity.

- ▶ Explanation of the 5-function button .



- UP button (▲) : Pressing the UP button (▲) makes the cursor move up.
 - DOWN button (▼) : Pressing the DOWN button (▼) makes the cursor move down.
 - LEFT button (◀) : Pressing the LEFT button (◀) makes the cursor move to the left.
 - RIGHT button (▶) : Pressing the RIGHT button (▶) makes the cursor move to the right
 - OK button : Pressing the OK button confirms the selection.
- ▶ When the menu is showing on the LCD monitor, it is not possible to operate the shutter button i.e. take an image. To take an image, simply cancel the menu display by pressing the MENU button. The menu will no longer show and the camera is ready to take an image.



SETTING UP THE SHOOTING FUNCTION

SIZE

- In STILL IMAGE and NIGHT SCENE mode, you can select the image size.
- A large image uses more memory, so increasing image size will reduce the total number of shots you can store on a CF CARD. The image sizes are listed below.

L 2048x1536 **P** 2048x1360 **M** 1024x768 **S** 512x384

1. Turn the camera power on.
2. Rotate the mode dial to the STILL IMAGE mode or NIGHT SCENE mode.
3. Do not turn the LCD monitor off.
4. Press MENU button to display the menu on the LCD monitor.
5. Press the DOWN button (▼) and select [SIZE].
6. The cursor can be moved by pressing the RIGHT button (►) to the [SIZE] sub menu.
7. Select the desired sub menu by pressing the UP (▲) / DOWN (▼) buttons. The default is 2048x1536.
8. After selecting the desired sub menu, press the OK button to confirm the setting.
9. Press the MENU button to cancel the menu display.

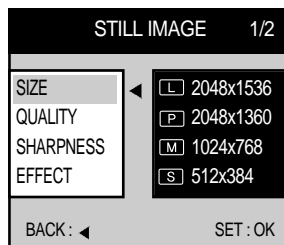

< STILL IMAGE mode >

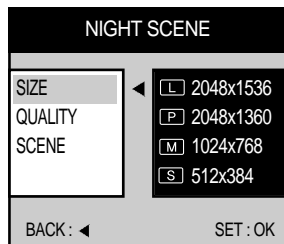

< NIGHT SCENE mode >



SETTING UP THE SHOOTING FUNCTION

QUALITY

- In STILL IMAGE, NIGHT SCENE modes, you can select the image data compression rate.
- The higher the QUALITY setting, the better the final image will be. However, the high quality setting will require more memory and therefore reduce the number of images you can store on the CF CARD.
- SUPER FINE is the highest quality and NORMAL is the lowest setting. Choose the setting appropriate for your needs.

1. Turn the camera power on.
2. Rotate the mode dial to STILL IMAGE mode or NIGHT SCENE mode.
3. Do not turn the LCD monitor off.
4. Press the MENU button to display the menu on the LCD monitor.
5. Press the DOWN button (▼) and select [QUALITY].
6. Shift the cursor to the [QUALITY] sub menu by pressing the RIGHT button (►)
7. Select the desired sub menu by pressing the UP (▲) / DOWN (▼) buttons. The default is FINE.
8. After selecting desired sub menu, press the OK button to confirm the setting.
9. Press the MENU button to cancel the menu display.

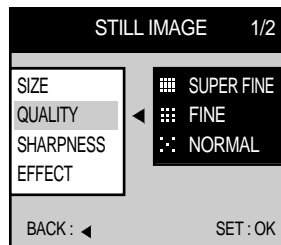

< STILL IMAGE mode >

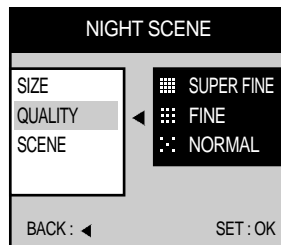

< NIGHT SCENE mode >



Reference

- The image file is stored in *.jpg.
- This file format complies with DCF(Design rule for Camera File system).



SETTING UP THE SHOOTING FUNCTION

SHARPNESS

- In the STILL IMAGE mode, you can select image sharpness.
 - Select the desired SHARPNESS (SOFT/ NORMAL/ HARD) depending on the subject matter.
1. Turn the camera power on.
 2. Rotate the mode dial to STILL IMAGE mode.
 3. Do not turn the LCD monitor off.
 4. Press the MENU button to display the menu on the LCD monitor.
 5. Press the DOWN button (▼) and select [SHARPNESS].
 6. Shift the cursor by pressing the RIGHT button (►) to the [SHARPNESS] sub menu.
 7. Select the desired sub menu by pressing the UP (▲) / DOWN (▼) buttons. The default is NORMAL.
 8. After selecting the desired sub menu, press OK button to confirm the setting.
 9. Press the MENU button to cancel the menu display.

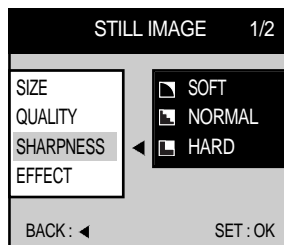

< STILL IMAGE mode >

ADVANCED



Reference

Explanation of SHARPNESS sub menu

- SOFT : This gives smooth edges and the final image will have a soft appearance.
- NORMAL : This setting will give a standard finish to the final image.
- HARD : This will give the image a crisp and clear appearance.



SETTING UP THE SHOOTING FUNCTION

EFFECT

- Using the camera's digital processor, it is possible to add special effects to your images.
- In STILL IMAGE or MOVIE CLIP mode, select the desired [EFFECT] sub menu.

1. Turn the camera on.
2. Rotate the mode dial to STILL IMAGE mode or MOVIE CLIP mode.
3. Do not turn the LCD monitor off.
4. Press the MENU button to display the menu on the LCD monitor.
5. Press the DOWN button(▼) and select [EFFECT].
6. Shift the cursor to the [EFFECT] sub menu by pressing the RIGHT button (►)
7. Select the desired sub menu by pressing the UP (▲) / DOWN (▼) buttons. The default is NORMAL.
8. After selecting the desired sub menu, press the OK button to confirm the setting.
9. Press the MENU button to cancel the menu display.



< STILL IMAGE mode >

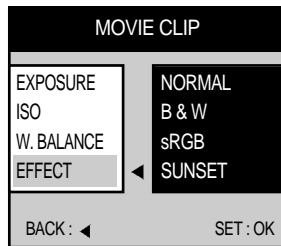

< MOVIE CLIP mode >



Reference

EFFECT sub menu explained

- NORMAL : No effect is added to the image.
- B & W : Converts the image to black and white.
- sRGB : sRGB is device independent standard color model.
Devices supporting sRGB can display exact image color.
- SUNSET : Used for sunset images.



SETTING UP THE SHOOTING FUNCTION

SHOOTING

- This allows continuous shooting.
- In this mode, you can take moving subjects continuously.
- Once a continuous shooting sequence has been completed, the camera resets to single shooting mode.

1. Turn the camera on.
2. Rotate the mode dial to STILL IMAGE mode.
3. Do not turn the LCD monitor off.
4. Press the MENU button to display [STILL IMAGE 1/2] menu on the LCD monitor.
5. Select [STILL IMAGE 2/2] menu by pressing the LEFT (◀) / RIGHT (▶) buttons.
6. Press the DOWN button (▼) and select [SHOOTING].
7. Shift the cursor to the [SHOOTING] sub menu by pressing the RIGHT button (▶)
8. Select the desired sub menu by pressing the UP (▲) / DOWN (▼) buttons. The default is SINGLE.
9. After selecting the desired sub menu, press the OK button to confirm the setting.

The number of shots in the continuous sequence will show if you select the [CONTINUOUS] icon and then press the OK button.

Select the number of continuous shots required.

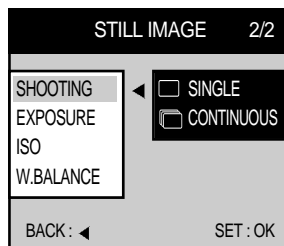



SETTING UP THE SHOOTING FUNCTION

■ Selecting the number of continuous shots

- Select the desired number by pressing the UP (▲) / DOWN (▼) buttons.
- Press the OK button.

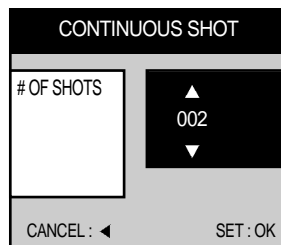

10. Press the MENU button to cancel menu display.



Reference

- When [CONTINUOUS] is selected, the flash will automatically be cancelled.
- Once a continuous sequence has begun, it will continue until the selected number of shots has been taken. Releasing the shutter button will not interrupt this function.
- The maximum number of shots in a sequence is governed by the image settings.
- Using a 16/32MB CF CARD, the specified shooting capacity will be as follows.
(These figures are intended as an indication of expected performance)

	SUPER FINE	FINE	NORMAL
2048X1536	5	10	15
2048X1360	5	10	16
1024X768	19	39	60
512X384	79	100	100

- These figures are approximate as image capacities can be affected by variables such as card performance and subject matter.



SETTING UP THE SHOOTING FUNCTION

EXPOSURE

- This camera automatically adjusts the exposure according to the ambient lighting conditions. However, you can select the exposure value by using [EXPOSURE] sub menu.
- This function can be used in STILL IMAGE and MOVIE CLIP mode.
- If you increase the exposure value, the image will be brighter.
- If you decrease the exposure value, the image will be darker.

1. Turn the camera power on.
2. Rotate the mode dial to STILL IMAGE or MOVIE CLIP mode.
3. Do not turn the LCD monitor off.
4. Press the MENU button to display the menu on the LCD monitor. In STILL IMAGE mode, press the LEFT (◀) or RIGHT (▶) button to select [STILL IMAGE 2/2] menu.
5. Press the DOWN button (▼) and select [EXPOSURE].
6. Shift to the [EXPOSURE] sub menu by pressing the RIGHT button (▶).

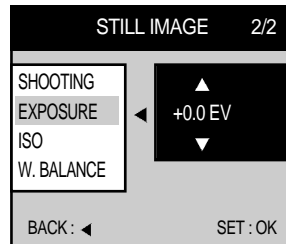

< STILL IMAGE mode >

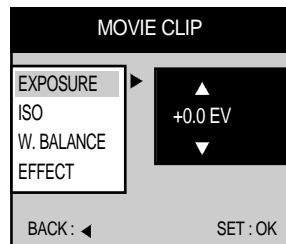

< MOVIE CLIP mode >



SETTING UP THE SHOOTING FUNCTION

7. Select the desired sub menu by pressing the UP (▲) / DOWN (▼) buttons.
The camera calculates the exposure value automatically. The default setting is 0.0 EV.
8. After selecting the desired sub menu, press the OK button to confirm the setting.
9. Press the MENU button to cancel menu display.



Reference

- Exposure compensation setting range : -2.0 ~ +2.0 EV (0.5 EV steps)
- This change to the exposure will remain until the camera is switched off.
When the camera is turned on again, the exposure compensation setting returns to 0.0EV (discarding the exposure compensation).
- When you have selected a change in exposure value, the value is displayed on the LCD.
- Decreasing or increasing the exposure value may lead to images being under or over exposed (too dark or too bright).
Review your images using the LCD monitor to check that they have been successful.



SETTING UP THE SHOOTING FUNCTION

ISO

- You can select the camera's sensitivity to light by selecting the ISO sub menu.
- Raising the ISO sensitivity will mean that the camera needs less light in order to take an image. However, the higher the ISO value is, the grainier the image will be.
 - AUTO : The camera's sensitivity is automatically changed by variables such as lighting value or subject brightness.
 - 100/200/400 : In the same lighting condition, the higher ISO value is, the faster the shutter speed will be. However, the images can be saturated with the high brightness condition.

1. Turn the camera on.
2. Rotate the mode dial to STILL IMAGE mode or MOVIE CLIP mode.
3. Do not turn the LCD monitor off.
4. Press the MENU button to display the menu on the LCD monitor. In STILL IMAGE mode, press the LEFT (◀) or RIGHT (▶) button to select the [STILL IMAGE 2/2] menu.
5. Press the DOWN button (▼) and select [ISO].
6. Shift to the [ISO] sub menu by pressing the RIGHT button (▶)
7. Select the desired sub menu by pressing the UP (▲) / DOWN (▼) buttons. The default is AUTO.
8. After selecting the desired sub menu, press the OK button to confirm the setting.
9. Press the MENU button to cancel menu display.

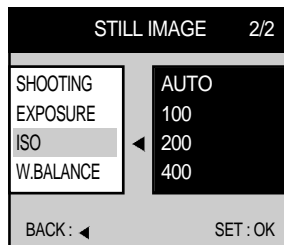

< STILL IMAGE mode >

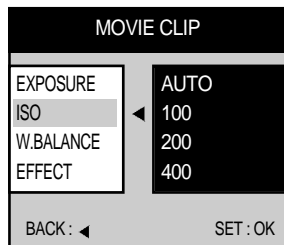

< MOVIE CLIP mode >



SETTING UP THE SHOOTING FUNCTION

W.BALANCE

- Different lighting conditions may cause a color cast on your images.
- The white balance control allows you to adjust the colors to appear more natural looking.
- The setting remains until the power is turned off.

1. Turn the camera power on.
2. Rotate the mode dial to STILL IMAGE mode or MOVIE CLIP mode.
3. Do not turn the LCD monitor off.
4. Press the MENU button to display the menu on the LCD monitor. In STILL IMAGE mode, press the LEFT (◀) or RIGHT (▶) button to select the [STILL IMAGE 2/2] menu.
5. Press the DOWN button (▼) and select [W.BALANCE].
6. Shift the cursor to the [W.BALANCE] sub menu by pressing the RIGHT button (▶)
7. Select the desired sub menu by pressing the UP (▲) / DOWN (▼) buttons. The default is AUTO.
8. After selecting the desired sub menu, press the OK button to confirm the setting.
9. Press the MENU button to cancel the menu display.

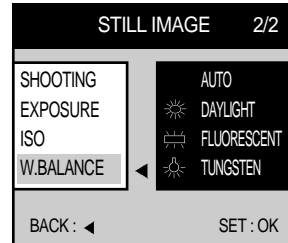

< STILL IMAGE mode >

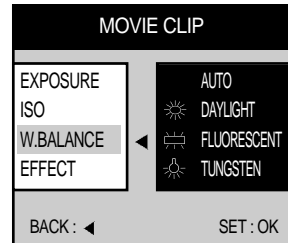

< MOVIE CLIP mode >



Reference

W.BALANCE sub menu explained

- **AUTO** : The camera automatically selects the appropriate white balance settings, depending on the prevailing lighting conditions.
- **DAYLIGHT** : For taking images outside.
- **FLUORESCENT** : For shooting under fluorescent lighting
- **TUNGSTEN** : For shooting under tungsten (standard lightbulb) lighting



SETTING UP THE SHOOTING FUNCTION

SCENE

- In NIGHT SCENE mode, Select the desired SCENE mode.
 - [PORTRAIT] mode (👤) : This is used for both portrait and landscape shots.
 - [LANDSCAPE] mode (🌄) : This is used for landscape shots.

1. Turn the camera on.
2. Rotate the mode dial to the NIGHT SCENE mode.
3. Do not turn the LCD monitor off.
4. Press MENU button to display the menu on the LCD monitor.
5. Press the DOWN button (▼) and select [SCENE].
6. Shift the cursor to the [SCENE] sub menu by pressing the RIGHT button (▶)
7. Select the desired sub menu by pressing the UP (▲) / DOWN (▼) buttons. The default is PORTRAIT.
8. After selecting the desired sub menu, press the OK button to confirm the setting.
9. Press the MENU button to cancel the menu display.

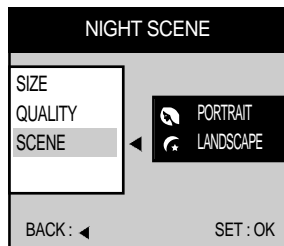

ADVANCED



Reference

- In NIGHT SCENE mode, don't move for a while after flash firing as the shutter speed is slow. We recommend using a tripod or supporting the camera on a solid object in order to avoid camera shake.



SETTING UP PLAY BACK FUNCTIONS

Starting Play Mode

- Turn the camera on and select () on the mode dial. The camera can now play back the images stored on the CF CARD. Sound can also be added to images in this mode.
- You can setup the PLAY mode function by using the camera buttons and LCD monitor.
- PLAY mode functions are listed below

Camera button		THUMBNAIL, ZOOM DELETE VOICE RECORDING PLAY & PAUSE
LCD monitor	Play back	SLIDE SHOW, PROTECT DELETE ALL, FORMAT
	Print setting	STANDARD, INDEX CANCEL, REVIEW



Reference

- ▶ The last image stored on CF CARD will be displayed on the LCD monitor.
- ▶ The LCD monitor will remain in operation until the camera is switched off.
- ▶ The menu will not display on the LCD monitor under following circumstances:
 - When another button is being pressed.
 - While image data is being processed.
 - When there is no battery capacity.



SETTING UP PLAY BACK FUNCTIONS

Setting up play back function by using the camera button

- The PLAY mode can be set using the camera button.

THUMBNAIL / ZOOM W button

- You can view up to 9 images at a time by using the THUMBNAIL function.

1. Turn the camera on.
2. Rotate the mode dial to PLAY mode.
3. An image displays on the LCD monitor.
4. Press the THUMBNAIL button.

The thumbnail display will highlight the image that had been showing at the time the thumbnail mode was selected.

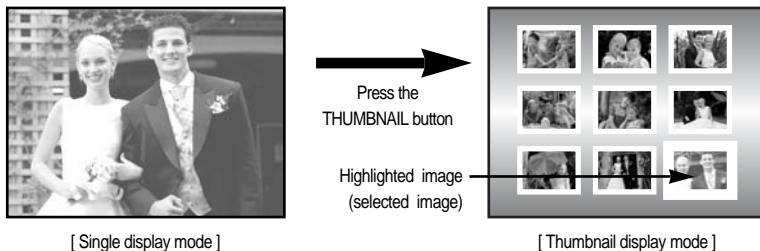

5. Press the ▲ / ▼ / ◀ / ▶ buttons to move to desired image. Selected image is highlighted. Icons are displayed to indicate the type of file selected.
 - : Movie clip file
 - : DPOF indicator
 - : Sound recorded file
 - : Image protect indicator
6. When viewing a thumbnail image, press the zoom T button and the selected shot will show in single display mode.



SETTING UP PLAY BACK FUNCTIONS

ZOOM W / ZOOM T button

- When viewing a single image in PLAY mode, use the zoom T button to enlarge the selected image.

1. Turn the camera on.
2. Rotate the mode dial to PLAY mode.
3. Select the desired image.
4. Enlarge the image up to the desired scale of enlargement by using the ZOOM T button.

The scale of enlargements is listed below.

- Image size is LARGE or PHOTO : 1.5 X ~ 5 X (0.5 step)
- Image size is MEDIUM : 1.5 X ~ 3 X (0.5 step)
- Image size is SMALL : 1.5 X

5. Different parts of the image can be viewed by pressing the ▲ / ▼ / ◀ / ▶ buttons.
6. Pressing the ZOOM W button will zoom back to the original full sized image.

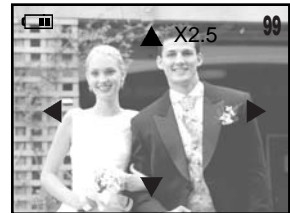

< Selecting 2.5 X >



Reference

- If an image is enlarged, the ratio indicator will display on the centre upper side of the LCD monitor.
- Movie clips cannot be enlarged.
- If an image is enlarged, a loss of quality may occur.



SETTING UP PLAY BACK FUNCTIONS

LCD button

- Pressing the LCD button will change the display as follows.
- You can view image information(Shutter speed, Aperture value, ISO sensitivity) in <Image with additional information> mode

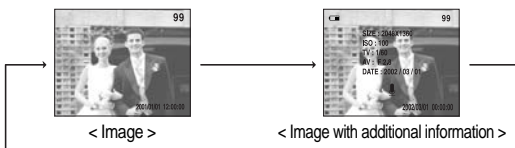

(e.g.)

SIZE : 2048X1360
ISO : 100
TV : 1/250 SEC → Shutter speed
AV : F2.8 → Aperture value
DATE : 2002 / 03 / 01

MENU button

- Pressing the MENU button will display the PLAY mode menu. Pressing the MENU button again will cancel the menu display.
- PLAY mode allows you to view either the PLAY menu or the DPOF (Digital Print Order Format) menu.

OK button

- When the LCD monitor is turned on, pressing this button allows the changed sub menu by using ▲ / ▼ / ◀ / ▶ button to confirm.



SETTING UP PLAY BACK FUNCTIONS

DELETE button

- This deletes image stored on the CF CARD.
1. Turn the camera power on.
 2. Rotate the mode dial to PLAY mode.
 3. Press the LEFT (◀) / RIGHT (▶) buttons to select image that you wish to delete.
 4. When you press the DELETE button, a message will be displayed on the LCD monitor.

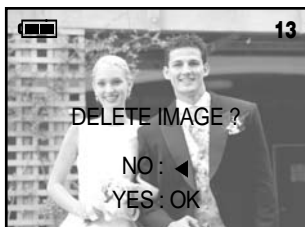

5. Select YES or NO.
 - Selecting YES : Press OK button.

Once an image has been deleted, the next image in the sequence will appear on the LCD display.
 - Selecting NO : Press the LEFT(◀) button. The image will be displayed on the LCD monitor.



SETTING UP PLAY BACK FUNCTIONS

MIC / UP button

- When the LCD monitor is turned on, pressing the ▲ button will either cause the cursor to move up or change a selected sub menu.
- When the LCD monitor is not turned on, pressing the ▲ button will allow a sound recording to be added to a stored still image.

1. Turn the camera on.
2. Rotate the mode dial to PLAY mode.
3. Press the LEFT (◀) / RIGHT (▶) buttons to select image that you wish to add sound to.
4. Press MIC button () and the sound recording indicator will display. The camera is now ready to record sound.



[Pressing MIC button]

5. Press the shutter button to start recording.
The [RECORDING..] message will be displayed on the LCD monitor (as shown) and sound is recorded to the still image.



[Being recorded]

6. The sound will record for ten seconds. Recording can be stopped by pressing the shutter button again.

When you press the shutter button to stop the sound recording, press the shutter button halfway and the buzzer sound will not be recorded.



40cm between you and the camera(microphone) is the best distance to record a sound.

PLAY & PAUSE / DOWN button

- When the LCD monitor is turned on, pressing the ▼ button will move the cursor down or change the sub menu.
- When the LCD monitor is not turned on, the ▼ button is used as the PLAY & PAUSE button.
- The PLAY & PAUSE button is used for playing and pausing a sound recorded still image, movie clip or slide show.
- The PLAY & PAUSE button will only operate in single display mode.



SETTING UP PLAY BACK FUNCTIONS

1. Turn the camera power on.
2. Rotate the mode dial to PLAY mode().
3. Press the LEFT () / RIGHT () buttons to select a sound recorded still image or a movie clip. Or, select slide show.
4. Press PLAY & PAUSE button.

PLAY & PAUSE explained

- If an image is showing, but there is no sound (or movement)
Press the PLAY& PAUSE button to play the sound clip or to start the movie clip.



[A sound recorded still image]



[A movie clip]

- If the image is playing : The progress is paused.



[A sound recorded still image]



[A movie clip]



[Slide show]

- If the PLAY & PAUSE button is pressed when the image is paused, the sound or movement will resume.



Reference

- When an image is being played back, you can use the PAUSE button, POWER button and the mode dial.
- When an image has paused, you can use the LEFT button, RIGHT button, POWER button, THUMBNAIL button and the mode dial.

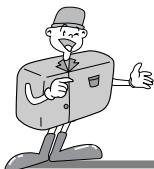

SETTING UP PLAY BACK FUNCTIONS

Setting up play back function using the LCD monitor

SLIDE SHOW

- Images can be displayed continuously at pre-set intervals.
1. Turn the camera power on.
 2. Rotate the mode dial to PLAY mode(▶).
 3. Press the MENU button to display the menu on the LCD monitor.
 4. Press the DOWN button(▼) and select [SLIDE SHOW].
 5. Shift the cursor to the [SLIDE SHOW] sub menu by pressing RIGHT button (▶).
 6. Select the desired sub menu by pressing the UP (▲)/DOWN (▼) buttons. The default is 3 seconds
 7. After selecting the desired sub menu, press the OK button to start the slide show.
 8. To stop the slide show, press the MENU button twice. Press the MENU button and the initial menu will be displayed. Press the MENU button again and the menu will be cancelled.

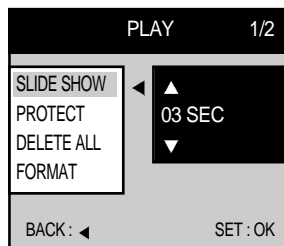





SETTING UP PLAY BACK FUNCTIONS

PROTECT

- This is used to protect specific shots from accidental erasing (LOCK). It also releases images that have been previously protected (UNLOCK).

1. Turn the camera on.
2. Rotate the mode dial to PLAY mode().
3. Press the MENU button to display the menu on the LCD monitor.
4. Press the DOWN button() and select [PROTECT]. At this point, a sub menu will be displayed as shown below.

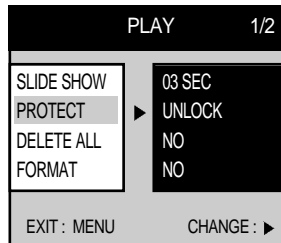

The display will show that the image will not be protected.

5. Shift the cursor to the [PROTECT] sub menu by pressing the RIGHT button ()

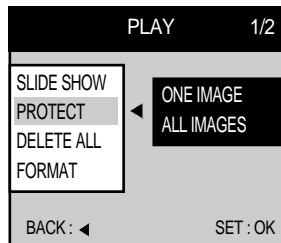



SETTING UP PLAY BACK FUNCTIONS

6. Select the desired sub menu by pressing the UP (▲) / DOWN (▼) buttons.
 - ONE IMAGE : This protects a single image.
 - ALL IMAGES : This protects all the images on the CF CARD.
7. Press the OK button and the PROTECT setting display will show on the LCD monitor.

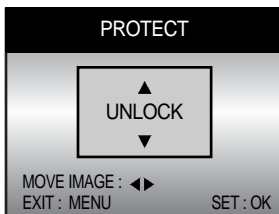

Select the desired sub menu by pressing the UP (▲) / DOWN (▼) buttons and press OK button.

- LOCK : Sets up the PROTECT function.
 - UNLOCK : Discards the protect function
8. If you select [ONE IMAGE] in step 6, the other image can be protected by pressing the LEFT(◀) / RIGHT(▶) button. The process of setting up is same as step 7.
 9. Pressing the MENU button clears the menu display and the LOCK indicator will show on the LCD monitor as shown below.

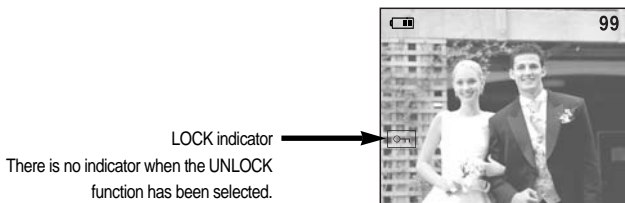

Reference





- An image in LOCK mode will be protected from [DELETE] or [DELETE ALL] functions, but will NOT be protected from the [FORMAT] function.



SETTING UP PLAY BACK FUNCTIONS

DELETE ALL

- This enables you to clear all unprotected images from the CF CARD.
- Remember that this will permanently delete unprotected images. Important shots should be stored on a computer before deletion takes place.

1. Turn the camera on.
2. Rotate the mode dial to PLAY mode().
3. Press the MENU button to display the menu on the LCD monitor
4. Press the DOWN button() and select [DELETE ALL].
5. Shift the cursor to the [DELETE ALL] sub menu by pressing the RIGHT button ()
6. Select the desired sub menu by pressing the UP () / DOWN () buttons and then press the OK button.
7. Select YES or NO.
 - Selecting YES : After deleting all images, [NO IMAGE !] message will show. Protected images are not deleted.
 - Selecting NO : The display is returned to initial menu, and [DELETE ALL] menu is highlighted. Press the MENU button, and the menu display will no longer show.





SETTING UP PLAY BACK FUNCTIONS

FORMAT

- This is used to format the CF CARD. all images INCLUDING protected images will be deleted.

1. Turn the camera on.
2. Rotate the mode dial to PLAY mode(▶).
3. Press the MENU button to display the menu on the LCD monitor.
4. Press the DOWN button(▼) and select [FORMAT].
5. Shift the cursor to the [FORMAT] sub menu by pressing the RIGHT button (▶)
6. Select the desired sub menu by pressing the UP (▲)/DOWN (▼) buttons and then press the OK button.
7. Select YES or NO

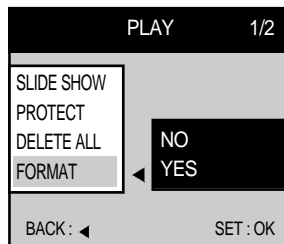

- Selecting YES : After formatting the CF CARD, [FORMAT OK!] message will show in the LCD monitor and the display is returned to initial menu.

Press the MENU button, and the [NO IMAGE !] message will show in the LCD monitor.

- Selecting NO : The display returns to the initial menu, and the [FORMAT] menu is highlighted. The menu display will no longer show if the MENU button is pressed.













SETTING UP PLAY BACK FUNCTIONS

DPOF (Digital Print Order Format)

- DPOF stores printing information onto the CF CARD, enabling you to have images printed directly from the CF CARD.
- Images can then be printed on DPOF printers, or at an increasing number of photo laboratories.
- This function is not adjusted to Movie clip.

STANDARD

- Only one image will be printed on a page.

1. Turn the camera on.
2. Rotate the mode dial to the PLAY mode ().
3. Press the MENU button to display [PLAY 1/2] menu on the LCD monitor.
4. Select [PLAY(DPOF) 2/2] menu by pressing the LEFT () / RIGHT () buttons.
5. Press the DOWN button() and select [STANDARD].
6. Shift the cursor to the [STANDARD] sub menu by pressing the RIGHT button ()
7. Select ONE IMAGE or ALL IMAGES
 - ONE IMAGE : Specifying the number of copies from a selected image.
 - ALL IMAGES : Specifying the number of copies from all images except for movie clips.
8. Press the OK button, and a menu confirming the number of copies will be displayed.
Select desired number of copies by pressing the UP () / DOWN() buttons and press OK button.
The maximum number of copies is 10.
9. If you select [ONE IMAGE] in step 7 , the DPOF can be set to the other image by pressing LEFT() / RIGHT() button.
The process of setting up is same as step 8.
10. Press the MENU button to cancel menu display.
If an image carries DPOF instructions, the DPOF indicator () will show.

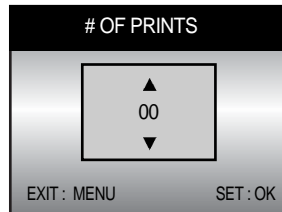
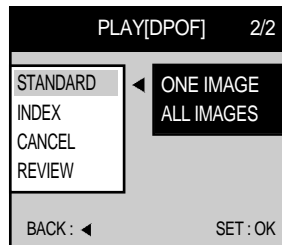



SETTING UP PLAY BACK FUNCTIONS

INDEX

- This function will specify the number of copies (except for movie clips) for index print.
- The maximum number of images for index print are 500.

1. Turn the camera on.
2. Rotate the mode dial to PLAY mode (▶).
3. Press the MENU button to display [PLAY 1/2] menu on the LCD monitor.
4. Select [PLAY(DPOF) 2/2] menu by pressing the LEFT (◀) / RIGHT (▶) buttons.
5. Press the DOWN button(▼) and select [INDEX].
6. Shift the cursor to the [INDEX] sub menu by pressing RIGHT button (▶)
7. Select desired sub menu by pressing the UP (▲) / DOWN (▼) buttons.
The maximum number of copies is 10.
8. After selecting the desired sub menu, press the OK button to confirm the setting.
9. The display is returned to [PLAY(DPOF) 2/2] menu, and the sub menu is highlighted.
Press the MENU button, and the menu display will no longer show.

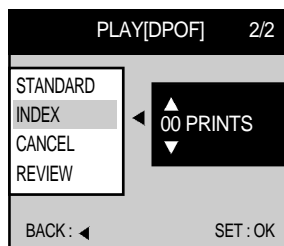









SETTING UP PLAY BACK FUNCTIONS

CANCEL



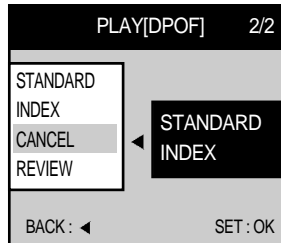

- This is used for canceling STANDARD or INDEX DPOF function.

1. Turn the camera on.
2. Rotate the mode dial to PLAY mode ().
3. Press the MENU button to display [PLAY 1/2] menu on the LCD monitor.
4. Select [PLAY(DPOF) 2/2] menu by pressing the LEFT () / RIGHT () buttons.
5. Press the DOWN button () and select [CANCEL].
6. Shift the cursor to the [CANCEL] sub menu by pressing the RIGHT button ()
7. Select the desired sub menu by pressing the UP () / DOWN () buttons.
8. After selecting the desired sub menu, press the OK button to confirm the setting.
The display is returned to [PLAY DPOF) 2/2] menu, and the sub menu is highlighted.
The number of copies will return to 00.
9. Press the MENU button to cancel the menu display.



REVIEW

- You can review specified number of STANDARD or INDEX copies.

1. Turn the camera on.
2. Rotate the mode dial to PLAY mode ().
3. Press the MENU button to display [PLAY 1/2] menu on the LCD monitor.
4. Select [PLAY (DPOF) 2/2] menu by pressing the LEFT () / RIGHT () buttons.
5. Press the DOWN button () and select [REVIEW] on the menu that is shown below.
6. Press the MENU button to cancel the menu display after reviewing the setting.

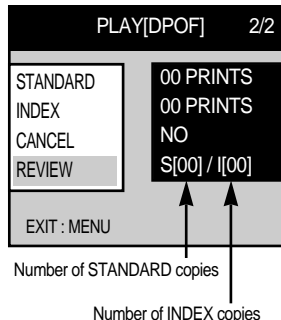

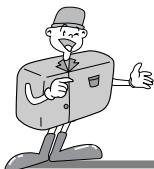

SETTING UP THE CAMERA SYSTEM

Starting Set up mode

- Rotate the mode dial to SET UP mode, allowing you to set up the basic camera settings.

FORMAT

- This is used for formatting the CF CARD.

1. Turn the camera on.
2. Rotate the mode dial to SET UP mode.
3. A menu will display on the LCD monitor.
4. Press the DOWN button (▼) and select [FORMAT].
5. Shift the cursor to the [FORMAT] sub menu by pressing the RIGHT button (►)
6. Select [YES] to format the CF CARD.
7. Press the OK button to format the CF CARD.

After formatting the CF CARD, [FORMAT OK!] message will show in the LCD monitor and the display is returned to initial menu.

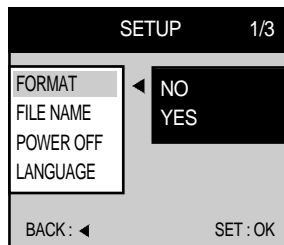

Reference

- You will need to format the CF CARD under the following circumstances:
 - If the card is new one or has not been previously formatted.
 - When the camera fails to read the images already stored on the card.

FILE NAME

- This enables you to name files
 - SERIES type : Under this system, the file name will directly follow the last stored file name, regardless of any actions such as file deletion or re-formatting.
 - RESET type : Using reset, the next file name will be set from 0001 even after formatting, deleting all or inserting a new CF CARD.



SETTING UP THE CAMERA SYSTEM

1. Turn the camera on.
2. Rotate the mode dial to SET UP mode (**SET**).
3. A menu will display on the LCD monitor.
4. Press the DOWN button (**▼**) and select [FILE NAME].
5. Shift the cursor to the [FILE NAME] sub menu by pressing the RIGHT button (**▶**).
6. Select the desired sub menu by pressing the UP (**▲**) / DOWN (**▼**) buttons. The default is SERIES.
7. After selecting the desired sub menu, press the OK button to confirm the setting.

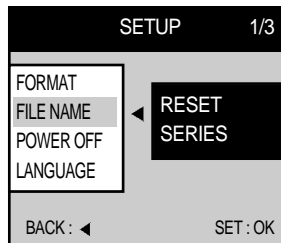

Reference

- The first stored folder name is 100SSCAM , and first name is S3500001
- Whenever you store an image, the file number is increased by 1.
- The file number is named from S3500001 to S3509999 automatically, 9999 files will be stored in a folder. Using SERIES, the sequence starts at 100SSCAM and increases in increments of 1. (e.g. : 101SSCAM, 102SSCAM.....)
- The files used with the CF CARD conform to the DCF (Design rule for Camera File system) format.



SETTING UP THE CAMERA SYSTEM

POWER OFF

- This function switches the camera off after a set amount of time in order to prevent unnecessary battery drainage.
- You can set the power to switch off at any time between one and ten minutes from the last operation.
- Setting this function to OFF means that the camera will not switch off automatically.
Note that the automatic power off does not operate if the camera is in slide show or PC mode.

1. Turn the camera on.
2. Rotate the mode dial to SET UP mode (**SET**).
3. A menu will display on the LCD monitor.
4. Press the DOWN button (**▼**) and select [POWER OFF].
5. Shift the cursor to the [POWER OFF] sub menu by pressing the RIGHT button (**▶**)
6. Select the desired sub menu by pressing the UP (**▲**) / DOWN (**▼**) buttons. The default is 3 minutes.
7. After selecting the desired sub menu, press the OK button to confirm the setting.

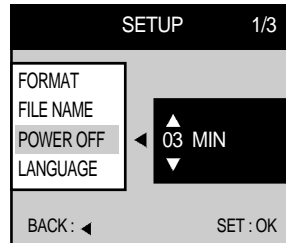

LANGUAGE

- There is a choice of languages that can be displayed on the LCD monitor.
- ENGLISH, GERMAN, FRENCH, SPANISH, CHINESE and KOREAN are available.

1. Turn the camera on.
2. Rotate the mode dial to SET UP mode (**SET**).
3. A menu will display on the LCD monitor.
4. Press the DOWN button (**▼**) and select [LANGUAGE].
5. Shift the cursor to the [LANGUAGE] sub menu by pressing the RIGHT button (**▶**)
6. Select the desired sub menu by pressing the UP (**▲**) / DOWN (**▼**) buttons.
7. After selecting the desired sub menu, press the OK button to confirm the setting.

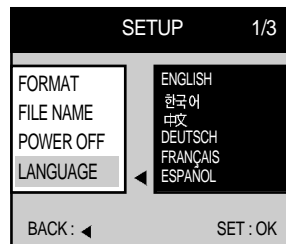



SETTING UP CAMERA SYSTEM

DATE SETUP

- This alters the time and date stored with the images.
- Range: 2001 ~ 2050 year (leap years and months are corrected automatically).
- The default is 2002/03/01 00:00.

1. Turn the camera on.
2. Rotate the mode dial to SET UP mode(**SET**).
3. [SETUP 1/3] menu will be displayed on the LCD monitor.
4. Select [SETUP 2/3] menu by pressing the LEFT (◀) / RIGHT (▶) buttons.
5. Press the DOWN button (▼) and select [DATE SETUP].
6. Shift the cursor to the [DATE SETUP] sub menu by pressing the RIGHT button (▶)
7. Press ▲ / ▼ / ◀ / ▶ to select correct time.
8. Press OK button to confirm the setting.

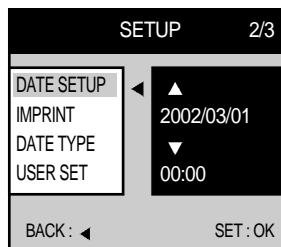

Note

- If the battery is removed, the date and time settings will remain for approximately 1 hour.
- If the batteries are removed for a period longer than one hour, it may be necessary to reset the time /date.



SETTING UP CAMERA SYSTEM

IMPRINT

- There is an option to include DATE/TIME on still images.
- There are 3 types of IMPRINT.
 - OFF: IMPRINT function is cancelled.
 - DATE: The date is included in the still image.
 - DATE & TIME: The date and time is included in the still image.
- This function is not available in movie clip shot.

1. Turn the camera on.
2. Rotate the mode dial to SET UP mode (**SET**).
3. [SETUP 1/3] menu will display on the LCD monitor.
4. Select [SETUP 2/3] menu by pressing the LEFT (**◀**) / RIGHT (**▶**) buttons.
5. Press the DOWN button (**▼**) and select [IMPRINT].
6. Shift the cursor to the [IMPRINT] sub menu by pressing the RIGHT button (**▶**)
7. Select the desired sub menu by pressing the UP (**▲**) / DOWN (**▼**) buttons. The default is OFF.
8. After selecting the desired sub menu, press the OK button to confirm the setting.

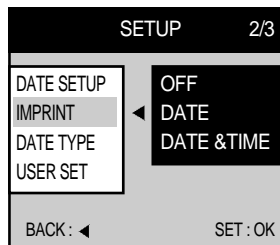

ADVANCED

- Recorded date and time will be imprinted in the bottom right hand corner of the image.



< Date imprinting >



< Date and Time imprinting >



SETTING UP CAMERA SYSTEM



Reference

- Date will be imprinted as DATE TYPE setting.
- TIME is imprinted in the following way: [hour / minute / second].
Hours are shown using the 24 hour clock.
- The IMPRINT function is unaffected by the camera being switched on and off.

DATE TYPE

- You can select date type that is imprinted on the image.
 - YYYY/MM/DD : year /month/ day
 - DD/MM/YYYY : day /month /year
 - MM/DD/YYYY : month/ day /year

1. Turn the camera on.
2. Rotate the mode dial to SET UP mode (SET).
3. [SETUP 1/3] menu will show on the LCD monitor.
4. Select [SETUP 2/3] menu by pressing the LEFT (◀) / RIGHT (▶) buttons.
5. Press the DOWN button (▼) and select [DATE TYPE].
6. Shift the cursor to the [DATE TYPE] sub menu by pressing the RIGHT button (▶)
7. Select the desired sub menu by pressing the UP (▲) / DOWN (▼) buttons. The default is YYYY/MM/DD.
8. After selecting the desired sub menu, press the OK button to confirm the setting.

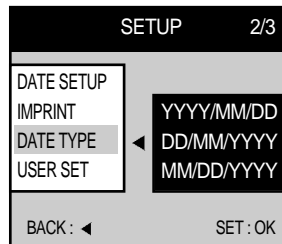



SETTING UP CAMERA SYSTEM

USER SET

- User can save the sub menu, that is returned to default when the camera power is off, as user preferences.
- Only 「◇」 marked sub menu in the [TABLE 1] can be applied to USER SET function.

1. Turn the camera on.
2. Rotate the mode dial to SET UP mode(SET).
3. [SETUP 1/3] menu will display on the LCD monitor.
4. Select [SETUP 2/3] menu by pressing the LEFT (◀) / RIGHT (▶) buttons.
5. Press the DOWN button (▼) and select [USER SET].
6. Shift the cursor to the [USER SET] sub menu by pressing the RIGHT button (▶)
7. Select the desired sub menu by pressing the UP (▲) / DOWN (▼) button and press the OK button.
The default is NO.
8. Select YES or NO.

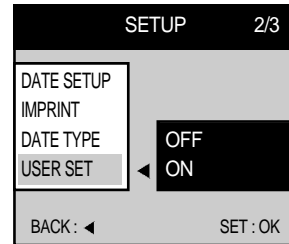

- Selecting YES. : The sub menu setting will be saved, even if the camera is switched off.
- Selecting NO. : If NO is selected, the camera will return to default when switched off.



SETTING UP CAMERA SYSTEM

< TABLE 1 > List of menu and sub menu

- Remarks ⊙ : Default x : There is no associated menu
 ○ : The setting is maintained even if the camera power is off.
 ◇ : The setting is returned to default, once the camera power has been switched off.
 △ : The setting is returned to default after the function has been completed.

						SET	
SHOOTING	SINGLE	⊙	x	⊙	x	x	x
	CONTINUOUS	△	x	x	x	x	x
FLASH	AUTO	⊙	x	◇	x	x	x
	AUTO & Red	◇	x	⊙	x	x	x
	SLOW SYNCHRO	◇	x	◇	x	x	x
	Fill in	◇	x	◇	x	x	x
	OFF	◇	⊙	◇	x	x	x
SIZE	Large	⊙	x	⊙	x	x	x
	Medium	○	x	○	x	x	x
	Small	○	x	○	x	x	x
	Photo	○	x	○	x	x	x
QUALITY	Super Fine	○	x	○	x	x	x
	Fine	⊙	x	⊙	x	x	x
	Normal	○	x	○	x	x	x
SHARPNESS	Soft	◇	x	x	x	x	x
	Normal	⊙	x	x	x	x	x
	Hard	◇	x	x	x	x	x
EFFECT	Normal	⊙	⊙	⊙	x	x	x
	B&W	◇	◇	x	x	x	x
	sRGB	◇	◇	x	x	x	x
	Sunset	◇	◇	x	x	x	x
EXPOSURE	+2.0EV	◇	◇	x	x	x	x
	0.0EV	⊙	⊙	⊙	x	x	x
	-2.0EV	◇	◇	x	x	x	x
ISO	Auto	⊙	⊙	⊙	x	x	x
	100	◇	◇	x	x	x	x
	200	◇	◇	x	x	x	x
	400	◇	◇	x	x	x	x
VOICE RECORDING	Enable	◇	⊙	◇	◇	x	x
	Disable	⊙	◇	⊙	⊙	x	x



SETTING UP CAMERA SYSTEM

SELF TIMER	ON	△	△	△	x	x	x
	OFF	⊙	⊙	⊙	x	x	x
METERING	C.W.A	⊙	⊙	⊙	x	x	x
	Center	◇	◇	◇	x	x	x
WHITE BALANCE	Auto	⊙	⊙	⊙	x	x	x
	Daylight	◇	◇	x	x	x	x
	Fluorescent	◇	◇	x	x	x	x
SCENE	Tungsten	◇	◇	x	x	x	x
	Portrait	x	x	⊙	x	x	x
	Landscape	x	x	◇	x	x	x
Slide Show setup		x	x	x	◇	x	x
Protect	One Image	x	x	x	△	x	x
	All Image	x	x	x	△	x	x
Delete All		x	x	x	△	x	x
Format		x	x	x	△	x	x
DPOF	Standard	x	x	x	△	x	x
	Index	x	x	x	△	x	x
	Cancel	x	x	x	△	x	x
	Review	x	x	x	△	x	x
File Name	Series	x	x	x	x	⊙	x
	Reset	x	x	x	x	○	x
Auto Power off	ON	x	x	x	x	⊙	x
	OFF	x	x	x	x	○	x
LANGUAGE	ENGLISH	x	x	x	x	⊙	x
	한국어, 中文, DEUTSCH	x	x	x	x	○	x
	FRANÇAIS, ESPAÑOL	x	x	x	x	○	x
Date setup		x	x	x	x	○	x
Imprint	Off	x	x	x	x	⊙	x
	Date	x	x	x	x	○	x
	Date & Time	x	x	x	x	○	x
Sound	On	x	x	x	x	⊙	x
	Off	x	x	x	x	○	x
LCD Brightness		x	x	x	x	○	x
Video out	NTSC	x	x	x	x	⊙	x
	PAL	x	x	x	x	○	x
QUICK View set		x	x	x	x	○	x



SETTING UP CAMERA SYSTEM

SOUND

- A beep will sound when you press the camera button.

1. Turn the camera on.
2. Rotate the mode dial to SET UP mode (**SET**).
3. [SETUP 1/3] menu will display on the LCD monitor.
4. Select [SETUP 3/3] menu by pressing the LEFT (**◀**) / RIGHT (**▶**) buttons.
5. Press the DOWN button (**▼**) and select [SOUND].
6. Shift the cursor to the [SOUND] sub menu by pressing the RIGHT button (**▶**)
7. Select the desired sub menu by pressing the UP (**▲**) / DOWN (**▼**) buttons
8. After selecting the desired sub menu, press the OK button to confirm the setting.

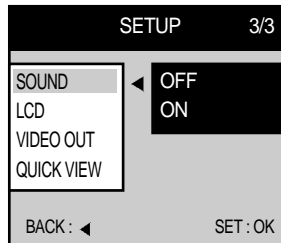

LCD

- You may adjust the LCD brightness.

1. Turn the camera on.
2. Rotate the mode dial to SET UP mode(**SET**).
3. [SETUP 1/3] menu will display on the LCD monitor.
4. Select [SETUP 3/3] menu by pressing the LEFT (**◀**) / RIGHT (**▶**) buttons.
5. Press the DOWN button (**▼**) and select [LCD].
6. Shift the cursor to the [LCD] sub menu by pressing the RIGHT button (**▶**)
7. Select the desired sub menu by pressing the UP (**▲**) / DOWN (**▼**) buttons. The LCD monitor has 7 brightness settings.
8. After selecting the desired sub menu, press the OK button to confirm the setting.

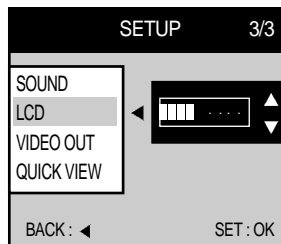



SETTING UP CAMERA SYSTEM

VIDEO OUT

- The Video output signal from the camera can be NTSC or PAL. Your choice of output will be governed by the type of machine (monitor or TV, etc.) to which the camera is connected.
- Select the correct video standard for the outer monitor. PAL mode can support only BDGHI.

1. Turn the camera on.
2. Rotate the mode dial to SET UP mode (**SET**).
3. [SETUP 1/3] menu will show on the LCD monitor.
4. Shift the cursor to the [SETUP 3/3] sub menu by pressing the RIGHT button (**▶**)
5. Press the DOWN button (**▼**) and select [VIDEO OUT].
6. Shift the cursor to the [VIDEO OUT] sub menu by pressing the RIGHT button (**▶**)
7. Select the desired sub menu by pressing the UP (**▲**) / DOWN (**▼**) buttons. The default is NTSC.
8. After selecting the desired sub menu, press the OK button to confirm the setting.

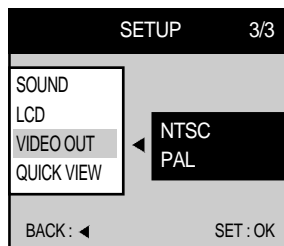

QUICK VIEW

- With QUICK VIEW you can pre-set the camera to briefly review the last image captured. It is possible to vary the time the image is visible, according to your particular requirements.

1. Turn the camera on.
2. Rotate the mode dial to SET UP mode (**SET**).
3. [SETUP 1/3] menu will display on the LCD monitor.
4. Select [SETUP 3/3] menu by pressing the LEFT (**◀**) / RIGHT (**▶**) buttons.
5. Press the DOWN button (**▼**) and select [QUICK VIEW].
6. Shift the cursor to the [QUICK VIEW] sub menu by pressing the RIGHT button (**▶**)
7. Select the desired sub menu by pressing the UP (**▲**) / DOWN (**▼**) buttons. The default is 1 second and you can change it up to 3 seconds.
8. After selecting the desired sub menu, press the OK button to confirm the setting.

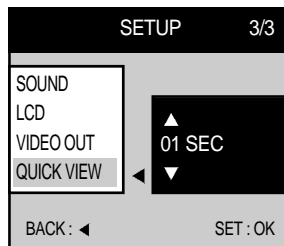



CONNECTING TO AN EXTERNAL MONITOR

Connecting to an external monitor

- In STILL IMAGE or PLAY mode, you can view the stored images or movie clips by connecting the camera to an external monitor via the video cable. When the camera is connected to an external monitor, the LCD monitor will be turned off automatically.
- When the camera is connected to a external monitor, the menu will be visible on the external monitor and the working of the menu is same as the LCD monitor.
- Selecting the Video output type
 - You can select an NTSC or PAL video output signal, depending on the external equipment (monitor or TV) that you wish to connect to.
 - Refer to page 77 [VIDEO OUT] about selecting the video output from the camera.



Reference

- When using a TV as an external monitor, you will need to select the external or AV channel of the TV.
- There will be a digital noise on the external monitor, but it is not malfunction.
- If the image is not in the centre of the screen, use the TV controls to centre it.



PC MODE

Functions of PC mode

Downloading stored images

- Once you have downloaded images to your PC, they can be edited and printed.
 - (1) Rotate the mode dial to PC mode, and turn the camera on.
 - (2) Connect the camera to your PC with the USB cable.
 - (3) On your computer's desktop display, select [My computer] and double click [Removable Disk]. The image files will then be displayed. Use the COPY or MOVE function to download the images to your PC.
 - (4) By using [Digimax Viewer], you can see the stored images in the CF CARD directly on the PC monitor and you can copy or move the image files.
 - (5) If you wish to edit downloaded images, you can use [MGI PhotoSuite III SE].

※ Refer to the software manual regarding editing software installation and usage.

- In this mode, you can download stored images to your PC through the USB cable.
- There is no menu in the PC mode.
- When you connect the camera to a PC, ensure that the mode dial is set on PC and that the mode dial lamp is illuminated.
- The Auto focus indicator(green) lamp blinks when the files are transferring via the USB connection.



Note

- The USB Storage Driver must be installed before using PC mode.
Refer to page 90 regarding installation.
- To save battery power, it is recommended that you use an AC adaptor(Optional) when connecting the camera to a computer



IMPORTANT NOTES

Caution!

- ▶ Your new Samsung camera is a precision instrument. Whilst it is designed to withstand general wear and tear, there are some important points that will help you get maximum service and reliability from your camera.

The following should be avoided :

- Severe changes in temperature and humidity.
 - Dust and dirt.
 - Direct sunlight or the inside of a vehicle in hot weather.
 - Environments where there is high magnetism or excessive vibration.
 - Areas with high explosives or highly flammable materials.
 - Pesticides, etc.
- ▶ Sand can be particularly troublesome to cameras.
 - Sand or other small particulates can cause severe malfunctions.Ensure that there is no contact with sand or similar particles.
- ▶ Extremes in temperature may cause problems.
 - If the camera is transferred from a cold to a warm and humid environment, condensation can form on the delicate electronic circuitry. If this occurs, turn the camera off and wait for at least 1 hour until all moisture is dispersed. Moisture build up can also occur in CF CARD. If this happens, turn off the camera and remove the CF CARD. Wait until the moisture has dispersed.



IMPORTANT NOTE

- ▶ If the digital camera is not used for a long period, an electric discharge can occur. It is a good idea to remove the batteries and CF CARD if the camera is not used for some time.
- ▶ If the camera is exposed to electronic interference, it will turn itself off to protect the CF CARD.
- ▶ Maintenance
 - Use a soft brush (available from photo stores) to GENTLY clean the lens and LCD assemblies. If this does not work, lens-cleaning paper with lens cleaning fluid can be used.
 - Clean the camera body with a soft cloth. Do not allow this camera contact with solvent materials such as benzol, insecticide, thinners etc.
This may damage the body shell of the camera and also affect its performance.
 - Rough handling can damage the LCD monitor. Take care to avoid damage and keep the camera in its protective carry case at all times.
- ▶ DO NOT attempt to disassemble or modify the camera. It contains delicate parts and there are high voltage circuits that can cause electric shocks.
- ▶ Under certain conditions, static electricity can cause the flash unit to fire.
This is not harmful to the camera and is not a malfunction.
- ▶ When images are uploaded or downloaded, the data transfer may be affected by static electricity. In this case, dis-connect and re-connect the USB cable before trying the transfer again.



IMPORTANT NOTE

Warning indicator

- There are several warnings that may appear in the LCD display :

Warning message	Reason for message	Remedy
NO CARD !	<ul style="list-style-type: none">• No CF CARD.• The camera cannot recognize the CF CARD.	<ul style="list-style-type: none">• Insert a CF CARD.• Remove and re-insert the CF CARD.• Turn the camera off, wait a few seconds and turn it on again.
NO IMAGE !	<ul style="list-style-type: none">• There are no images stored on the CF CARD.	<ul style="list-style-type: none">• Take images.• Insert a CF CARD that is holding some images.
CARD FULL !	<ul style="list-style-type: none">• There is insufficient memory capacity to take an image.	<ul style="list-style-type: none">• Insert a new CF CARD, or delete stored images to free up some memory.
CARD FAIL !	<ul style="list-style-type: none">• There is a malfunction in the CF CARD.	<ul style="list-style-type: none">• Insert a new CF CARD.
LOW BATTERY !	<ul style="list-style-type: none">• There is low battery capacity.	<ul style="list-style-type: none">• Insert fresh batteries.



BEFORE CONTACTING SERVICE CENTER

Please check the following

Symptom	Cause	Remedy
The camera will not switch on.	<ul style="list-style-type: none"> • Batteries need replacing. • AC Power Adapter is not connected. 	<ul style="list-style-type: none"> • Insert fresh batteries. • Connect AC Power Adapter.
The camera powers down whilst in use.	<ul style="list-style-type: none"> • The batteries are exhausted. • Camera is turned off automatically due to the Auto power function. • Adapter plug is not connected securely. 	<ul style="list-style-type: none"> • Insert fresh batteries. • Press power switch to re-activate camera. • Remove and re-insert plug.
Batteries drain quickly.	<ul style="list-style-type: none"> • Camera being used in low temperatures. • Mixing old and new batteries or battery types. 	<ul style="list-style-type: none"> • Keep camera in warm conditions (i.e. inside a coat or jacket) and only remove it in order to take images. • Insert fresh batteries (all of which should be of the same type)
Camera does not take images when pressing the Shutter button.	<ul style="list-style-type: none"> • CF CARD is not inserted • The CF CARD has not been formatted. • The CF CARD is full. • The camera power is off. • The batteries are exhausted • The mode dial is positioned incorrectly. 	<ul style="list-style-type: none"> • After turning the camera off, insert card. • Format the card. • Insert new CF CARD. • Turn the camera power on. • Insert fresh batteries • Rotate the mode dial to shot mode.



BEFORE CONTACTING SERVICE CENTER

Please check the following

Symptom	Cause	Remedy
The images are unclear.	<ul style="list-style-type: none">• The focus mode is not correct.	<ul style="list-style-type: none">• If the subject is closer than 0.8m, select macro shot mode.• Use Fixed focus when you cannot use auto focus mode.
The flash does not fire.	<ul style="list-style-type: none">• FLASH OFF mode have been selected.	<ul style="list-style-type: none">• Dis-engage FLASH OFF mode.
Incorrect date and time is displayed.	<ul style="list-style-type: none">• The date and time have been set incorrectly or the camera has adopted the default settings.	<ul style="list-style-type: none">• Reset the date and time correctly. Refer to page 24.
The camera buttons do not operate.	<ul style="list-style-type: none">• Camera malfunction	<ul style="list-style-type: none">• Remove /re-insert batteries and switch camera on.
CF CARD error.	<ul style="list-style-type: none">• Incorrect CF CARD format	<ul style="list-style-type: none">• Re-format the CF CARD. Refer to page 67.
Color of image different to original scene.	<ul style="list-style-type: none">• W.BALANCE setting is incorrect.	<ul style="list-style-type: none">• Select appropriate W.BALANCE. Refer to page 50.
Images are too bright.	<ul style="list-style-type: none">• Exposure is excessive.	<ul style="list-style-type: none">• Reset exposure compensation. Refer to page 47.



BEFORE CONTACTING SERVICE CENTER

Symptom	Cause	Remedy
Images are not very clear.	<ul style="list-style-type: none"> The lens or LCD monitor is smudged or dirty. 	<ul style="list-style-type: none"> Clean the lens or LCD monitor (refer to lens cleaning section page 81)
DATE/TIME is not displayed on the image.	<ul style="list-style-type: none"> Images taken without date imprinting setting. 	<ul style="list-style-type: none"> Select the imprinting function. Refer to page 71.
No image on external monitor	<ul style="list-style-type: none"> The external monitor has not been connected properly with the camera. There are incorrect files in the CF CARD. 	<ul style="list-style-type: none"> Check the connection cables. Insert CF CARD that have correct files.
When using the PC's explorer, 'Removable Disk' file does not show.	<ul style="list-style-type: none"> Cable connection is incorrect. The camera is off. There are no batteries, the batteries are exhausted or the AC adapter is not connected. The operating system is not Windows 98, 2000, ME, XP. Alternatively the PC does not support USB. USB driver is not installed. The mode dial is not set on PC mode. 	<ul style="list-style-type: none"> Check the connection. Turn the camera on. Insert new batteries or check the adapter connection. Install Windows 98, 2000, ME, XP Install "USB Storage Driver" Select PC mode on the dial



SPECIFICATIONS

Image Sensor	Type	1/1.8" CCD
	Effective Pixels	Approx. 3.2 Mega pixels
	Total Pixels	Approx. 3.3 Mega pixels
Lens	Focal Length	f = 7.0 ~ 21.0mm (35mm film equivalent : 34 ~ 102mm)
	F No.	F2.6 ~ F4.7
	Digital Zoom	Still Image mode : 1.5X, 2X Play mode : Small 1.5X, Medium 1.5X ~ 3X (0.5X steps), Large & Photo 1.5X ~ 5X (0.5X steps)
Viewfinder	Optical Viewfinder	Real image optical viewfinder
	LCD Monitor	1.5" color TFT LCD (117,600 dots, 490x240)
Focusing	Type	TTL autofocus / Fixed focus (1.0m, 2.5m, infinity)
	Range	Normal : 0.8m ~ infinity Macro : 0.2 ~ 0.8m
Shutter	Type	Mechanical and Electronic shutter
	Speed	4 ~ 1/2,000 sec.
Exposure	Control	Program AE (Center Weighted Average / Center)
	Compensation	±2EV (0.5EV steps)
	ISO Equivalent	Auto, 100, 200, 400
Flash	Modes	Auto / Red - eye reduction / Slow sync / Fill-in flash / Flash off
	Range (ISO AUTO)	Wide : 0.2 ~ 3.0m, Tele : 0.2 ~ 2.0m
	Recharging Time	Approx. 7 sec.
Sharpness		Soft / Normal / Hard
Effect		Normal / B&W / sRGB / Sunset
White Balance		Auto / Daylight / Fluorescent / Tungsten
Shooting	Still Image	Modes : Single / Continuous
	Night Scene	Portrait / Landscape
	Movie Clip	With Voice Size : 320x240
Self-timer		10 sec.
Storage	Media	CompactFlash™ card (up to 512MB guaranteed)
	File Format	Still Image : JPEG (DCF), DPOF Movie Clip : AVI (MJPEG)
	Image Size	Large : 2048x1536 pixels, Photo : 2048x1360 pixels Medium : 1024x768 pixels, Small : 512x384 pixels



SPECIFICATIONS

	Capacity (16/32MB)	Large : Super fine 9/19, Fine 19/39, Normal 29/59 Photo : Super fine 10/22, Fine 22/45, Normal 32/66 Medium : Super fine 38/77, Fine 75/153, Normal 110/225 Small : Super fine 163/333, Fine 269/547, Normal 377/767 * These figures are measured under Samsung's standard conditions and may vary depending on shooting conditions and camera settings.
Image Play		Single image/ Thumbnails / Slide show
Interface		Digital output connector : USB Movie output : NTSC / PAL (user selectable) Audio : Mono DC power input connector : 6.0V
Power Source		4 x AA alkaline / 4 x Ni-MH / 2 x CR-V3 batteries AC adapter (optional)
Dimensions (WxHxD)		114x70x49.9mm / 4.5x2.8x2.0in
Weight		240g / 9.0oz (without batteries and card)
Software	Camera Driver	Storage Driver (Windows98/98SE/2000/ME/XP, Mac OS 9.x or later)
	Application	MGI PhotoSuite, Digimax Viewer

System Requirements	Digimax 350SE
For Windows	PC with processor better than MMX Pentium 233MHz (XP : Pentium II 300MHz) Windows 98/98SE/2000/ME/XP Minimum 32MB RAM (XP : 128MB) 140MB of available hard-disk space USB port CD-ROM drive 800 x 600 pixels, 16-bit color display compatible monitor (24-bit color display recommended)
For Macintosh	Power Mac G3 or later Mac OS 9.x or later Minimum 64MB RAM 110MB of available hard-disk space USB port CD-ROM drive QuickTime 4.0 or later for Movie Clip

ADVANCED

※ Specifications are subject to change without prior notice.



SOFTWARE MANUAL

Please ensure that you read the instruction manual carefully before using

► **Software Notes**

- The attached software is a camera driver and image editing software tool for Windows.
- Under no circumstances should all or part of either the software or the user manual be reproduced.
- Copyright for both software is licensed only for use with a camera.
- In the unlikely event of a manufacturing fault, we will repair or exchange your camera. We cannot, however, be held responsible in any way for damage caused by inappropriate use.
- Using Hand-made PC or a PC that have not been guaranteed by the manufacturer are not covered by Samsung warranty.
- Before reading this manual, you should have a basic knowledge of computers and O/S (Operating Systems).
 - ※ Windows is a registered trademark of Microsoft.
 - ※ Macintosh, Mac is the registered trademark of Apple computer, USA.

About softwares

► **USB Storage Driver**

- This camera uses USB Storage Driver as the camera driver. You can use the camera as a USB card reader. After installing the driver and connecting this camera to the PC, you can find [Removeable Disk] in [Windows Explorer] or [My computer].
USB Storage Driver is provided only for Windows.
USB Driver for MAC is not included with the Application CD. But you can use the camera with Mac OS 9.x.

► **Digimax Viewer**

- You can see the stored images in the CF CARD directly on the PC monitor. And you can copy, move, delete the image and scale up /downscale the image size with Digimax Viewer. For windows only.

► **MGI PhotoSuite III SE**

- Image editing program for downloaded image.
For Windows only.



HOW TO SET UP THE SOFTWARE FOR WINDOWS

How to set up the software

- Inserting the CD-ROM provided with this camera into the CD-ROM drive, the following frame is automatically run.



- 1.Driver : This enables image to transfer between the camera and PC.
 - Driver installation for Windows : refer to page 90
 - Driver installation for Macintosh : refer to page 117
- 2.Image Viewer : Digimax Viewer. Refer to page 92
- 3.Application : MGI PhotoSuite III SE : image editing program. Refer to page 94.
- 4.Internet link : You can visit the Samsung web-site through the internet.
 - <http://www.samsungcamera.com> : English
 - <http://www.samsungcamera.co.kr> : Korean

Reference

- Check the system requirements (87 page) before setting up the driver.
- You should allow 5~10 seconds for running the automatic setup program according to the capability of the computer. If the frame does not show, run the [Windows Explorer] and select [Samsung.exe] in the CD-ROM Drive root directory.



HOW TO SET UP THE SOFTWARES FOR WINDOWS

Setting up USB driver for Windows

To use this camera with a PC, first install the Camera Driver. After this has been done, the stored images in the camera can be moved to the PC and can be edited by an image editing program.

- 1 Click [Storage Driver] menu on the Autorun frame and the 'InstallShield Wizard' Window will open.
Click [Next >].

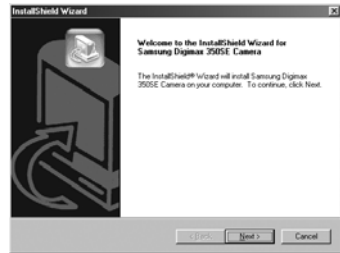

- 2 [Storage Driver] installation has started.

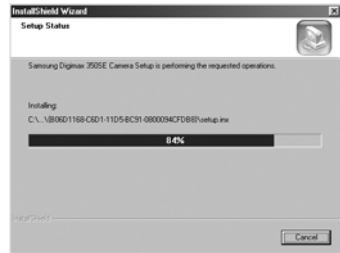

- 3 Installation is complete.
Click [Yes, I want to restart my computer now.] to restart your computer.





HOW TO SET UP THE SOFTWARES FOR WINDOWS

Setting up USB driver for Windows

4 After restarting computer, connect the PC to the camera with the USB cable.

5 Turn the camera power on with the mode dial set on PC.
[Found New Hardware Wizard] will appear and the computer will recognize the camera. If the PC OS is Windows 98/98SE, [Found New Hardware Wizard] will start twice. Don't close the [Found New Hardware Wizard] whilst it is being processed.

6 USB Driver installation is complete. After installation, [Removable Disk] will be displayed under [My computer] as shown alongside.



Note

- Before connecting the camera to the PC, you must install the camera driver.
- If the camera is connected to PC before Driver installation, [Found New Hardware Wizard] will appear. In this case, cancel [Found New Hardware Wizard] and disconnect camera from PC. Install the camera driver first and connect the camera to PC again.(Refer to page 97 about connecting the camera to PC)
- After driver installation, you have to restart the computer.
- Should the computer not find the Camera Driver after installation, please try one or more of the following measures.
 1. Delete the camera driver, and re-install the driver.
 2. Refer to FAQ to check for a possible solution to the problem.
- Do not click [Storage Driver] menu on the Autorun frame again after the camera driver installation, as the camera driver can be removed.
- If your PC's central processing unit is VIA Chip (This is shown in the USB Host Controller), download the patch file from the Samsung Camera webpage.
<http://www.samsungcamera.com>



HOW TO SET UP THE SOFTWARES FOR WINDOWS

Setting up Digimax Viewer

This software is only compatible with Windows.

1 Click [Digimax Viewer] on the Autorun frame .

2 Installation window will display as shown alongside. Click [Next].



3 The Software License Agreement window will display. If you agree to it, click [Yes]. This will take you to the next step. If you disagree, click [No] and the installation program will be canceled.



4 Select destination folder and click [Next].

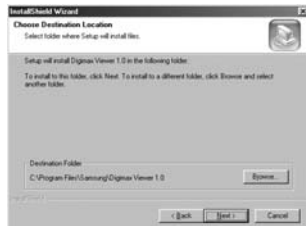



HOW TO SET UP THE SOFTWARES FOR WINDOWS

Setting up Digimax Viewer

5 Select Program folder and click [Next].

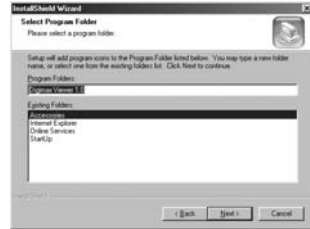

6 Setup status window will display.

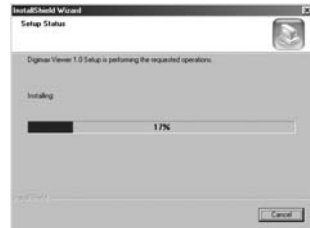

7 Installation is completed. If you wish to open this program automatically whenever the camera connects to PC, click [I would like to launch Digimax Viewer] Checkbox. And click [Finish].

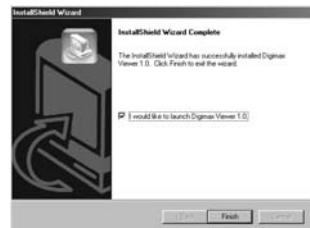



HOW TO SET UP THE SOFTWARES FOR WINDOWS

Setting up the MGI PhotoSuite III SE

1 Click the MGI PhotoSuite III SE menu on autorun frame.

2 Select language.



3 A Welcome window will be displayed. Click [Next >] to move to the next step.



4 The Software License Agreement window will be displayed.

If you agree to this, click [Yes], the window will then move to the next step. If you disagree, click [No] and the install program will be canceled.





HOW TO SET UP THE SOFTWARES FOR WINDOWS

- 5 Select setup type.
- Full : the program will be installed with all the options.
 - Custom : you can choose what you would like to install.



- 6 Start Copying Files window will display.
- Click [Next >] to start installation.



- 7 The MGI Registration window will be displayed before completing installation.
- Register : send your personal information to MGI for registration.
 - Cancel : postpone registration.

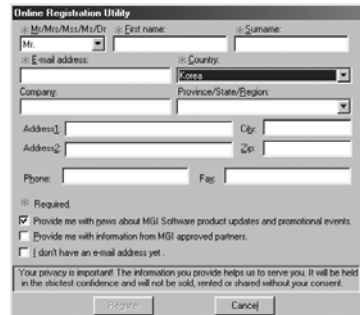



HOW TO SET UP THE SOFTWARES FOR WINDOWS

8 Installation is completed.



- ▶ If installation is completed correctly, Autoplay is registered automatically into the start menu program as shown alongside.





CONNECTING THE CAMERA FOR WINDOWS

Connecting USB cable to the Camera for Windows

- To download images, you will need Windows 98 or later and a USB port on your computer.

- 1 Connect the USB cable to the USB port on the computer.
- 2 Connect the other end of the USB cable to the USB connection terminal of the camera.
- 3 Set the mode dial to ()
- 4 Switch the camera on.



Removable Disk

- To use this camera as a Removable Disk, install the USB Driver.

- 1 Before turning the camera power on, connect the camera to the PC with the USB cable and rotate the mode dial to PC mode.
- 2 Click [Removable Disk] under [My computer] or [Windows Explorer].
- 3 Image files stored in the Removable Disk can be transferred to the PC.



REMOVABLE DISK



Note

- ▶ Important information whilst using the Removable Disk
 - The [Removable Disk] indicator will not show when the camera power is off.
 - We recommend that you should copy the images to the PC to view them. Opening images directly from the removable disk may be subject to unexpected disconnection.
 - When uploading images from the PC to the camera, ensure that the uploaded file names are not the same as those already stored on the CF CARD.
Files with the same file name but different extensions (e.g : S3500001.jpg/S3500001.avi),JPG file format will appear first. And if the displayed file is deleted, all the same file name images are deleted.
 - When you upload a file that is not taken by this camera to Removable Disk, the ERROR FILE message will be displayed on the LCD monitor in PLAY mode, and nothing is displayed in THUMBNAIL mode.
 - The green lamp next to the viewfinder will blink, when a file is transferred (copy or deletion) between the PC and camera. Do not remove the USB cable or rotate the mode dial until the lamp stops blinking. To remove the USB cable, use the [Unplug or Eject Hardware] icon on the task bar. In Windows 2000, take extra care, as the following may occur.
 1. When an image file from the Removable Disk is deleted : The green lamp will blink for about 10 seconds after file deletion is completed on the PC.
 2. When an image file is transferred between PC and Removable Disk : The green lamp will blink again 15-20 seconds after the first time it blinks.
The work is not completed until the lamp has finished blinking.
 - Uploading the sound recorded image to the camera, you should upload both WAV and JPG file. For example, if you upload S3500001.wav file to the camera, S3500001.jpg file has to be uploaded.





REMOVABLE DISK



Reference

When a downloaded movie won't play back, follow the procedure below.

[Solution 1] Install JPEG_Decoder.

1. Insert Application CD in CD-ROM Drive.
2. Open [Windows Explorer] and double click JPEG_Decoder folder in CD-ROM Driver folder.
3. Select [Jpegcode.inf] in JPEG_Decoder folder and click right button of mouse.

Then, click [Install] and the movie compression code is automatically set up.

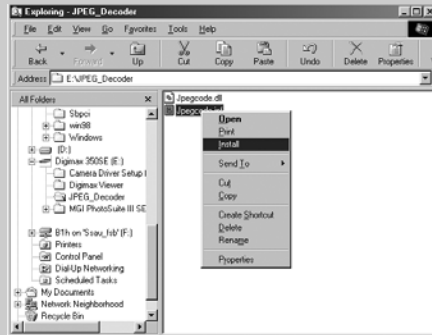

[Solution 2] Install QuickTime.

- QuickTime is a trademark of Apple Computer, Inc. and can be downloaded from <http://www.apple.com/quicktime/download> for free.



HOW TO USE THE SOFTWARES

Digimax Viewer

This software is only compatible with Windows.

To open Digimax Viewer, click the [Start → Programs → Samsung → Digimax Viewer 1.0 → Digimax Viewer 1.0] and Digimax Viewer 1.0 will then open.

- The stored images will display as thumbnail image.
- You can easily copy, move and delete the stored images.

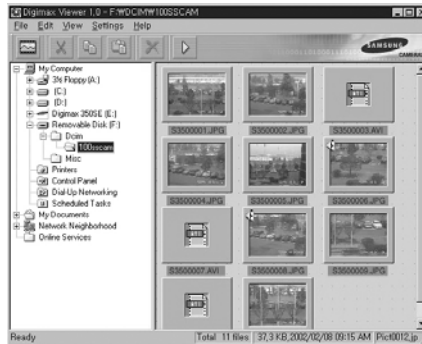

If the Auto Launch option is selected, this program will be executed automatically with recognizing the camera.

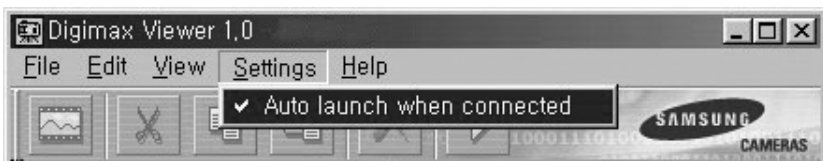

* Refer to [Help] menu in Digimax viewer about further information.



HOW TO USE THE SOFTWARES

MGI PhotoSuite III SE

This software is only compatible with Windows.

To open MGI PhotoSuite III SE, click the [Start → Programs → MGI PhotoSuite III SE → MGI PhotoSuite III SE] and MGI PhotoSuite III SE will then open.











HOW TO USE THE SOFTWARES

MGI PhotoSuite III SE

► An introduction to the Welcome screen









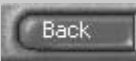

	<p>Get</p> <p>Get images.</p>
	<p>Prepare</p> <p>A number of photo editing activities can be performed within this module.</p>
	<p>Compose</p> <p>Use your photos in a variety of fun, creative and interesting ways.</p>
	<p>Organize</p> <p>Organize your photos and other media files into albums.</p>
	<p>Share</p> <p>Save your results to show to others.</p>
	<p>Print</p> <p>Print hard copies of photos and projects.</p>

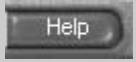

HOW TO USE THE SOFTWARES

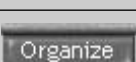
◆ Introdution to navigation bar

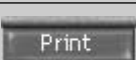

	Back Return to the previous step.
	Home Return to Welcome screen.
	Help Display help window.
	Get Get images.
	Prepare A number of photo editing activities can be performed within this module.
	Compose Use your photos in a variety of fun and interesting ways.
	Organize Organize your photos and other media files into albums.
	Share Save your results to show to others.
	Print Print hard copies of photos and projects.
	Browse Browse the web site.



HOW TO USE THE SOFTWARES

MGI PhotoSuite III SE

GET : Get images

► To obtain images from the computer

1 To acquire images, Click the large [Get] button on the Welcome screen, or the [Get] button on the Navigation bar. Click [Computer] from the list of options displayed on the activity panel.



2 The Open file selector is displayed. Now select the image file and click [open].



3 The Welcome screen will change to the next work step, with the selected image displayed.

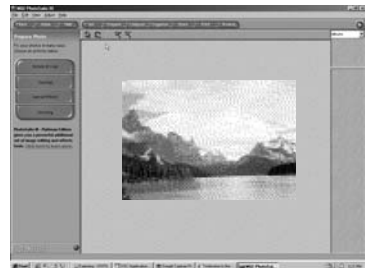



HOW TO USE THE SOFTWARES

MGI PhotoSuite III SE

- ▶ When you obtain images from the digital camera.



Note

- When you connect a PC to the Camera, use the following sequence :
 1. Turn the Mode dial to PC mode.
 2. Turn the power on.
 3. Connect the USB cable.

※ Refer to page 97 for more information about connecting the cable.

- 1 To acquire images, click the large [Get] button on the Welcome screen, or the [Get] button on the Navigation bar. Click [Computer] from the list of options displayed on the activity panel.



- 2 The Open file selector is displayed. Click [Look in :] to choose Removable Disk (:) and click [open] for the open file window to be displayed.





HOW TO USE THE SOFTWARES

MGI PhotoSuite III SE

- 3 Select [Dcim -> 100sscsm] folder. Then select image and click [Open].



- 4 The Welcome screen will change to the next work step, with the selected image displayed.



Reference

When you use the Digimax camera, only [Computer] and [Album] from the list of options displayed are available. You will be able to obtain images from the digital camera.



[Computer and Album Only]



HOW TO USE THE SOFTWARES

MGI PhotoSuite III SE

► Acquiring images from an Album.

- 1 To acquire images, click the the large [Get] button on the Welcome screen, or the [Get] button on the Navigation bar. Click [Album] from the list of options displayed on the activity panel.
- 2 After selecting Album on the ① Choose a photo album, click an image in the album and click [Open].
- 3 The Welcome screen will change to the next work step, with the selected image displayed.



※ Refer to page 111 for more information about creating an Album.



HOW TO USE THE SOFTWARES

MGI PhotoSuite III SE

PREPARE

When the image is loaded, the step changes to Prepare automatically.

■ Menu of [PREPARE] step

· **Rotate & Crop**

You can rotate, flip or crop images along with a host of others.

· **Touchup**

Remove Red eye, Remove Scratches etc.. are available in this menu.

· **Special Effects**

A number of special effects can be applied.

· **Stitching**

Join a series of photos together to create a sweeping panoramic effect.

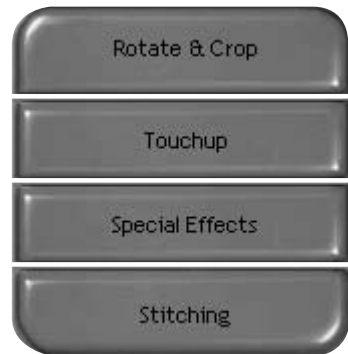



HOW TO USE THE SOFTWARES

MGI PhotoSuite III SE

COMPOSE

Add Text , Compound Images etc.. are available in this step.

■ Menu of [COMPOSE] steps

- **Collages** : A collage consists of several photos or sections of photos arranged together on a common background.
- **Photo Layouts** : The Photo Layouts activity includes many collage and layout options.
- **Cards & tags** : Use your photos to create items such as Gift Tags, Greeting Cards, Invitations, Postcards, and Sports Cards.
- **Calendars** : Use your photos to create a variety of calendars (monthly, quarterly,seasonal, yearly).
- **Collections** : Photos can also be used to create a variety of items for business purposes.

Add frames and boarder effects to your photos with the predefined templates.





HOW TO USE THE SOFTWARES

MGI PhotoSuite III SE

ORGANIZE

Organize your photos and other media files into albums.

■ Menu of [ORGANIZE] step

- ① Choose a photo album to view or edit
Select Album : To create an Album, click [Organize] in the welcome screen or navigation bar.
Album.. : Open Master Album.
- ② Select a photo, and choose an action below.
Open : Open selected image.
Delete : Delete selected image.
Properties.. : view image information.
- ③ Choose an action to manage your album.
Add : click [Add] to add an image to an Album.
Sort : click [Sort] to Sort saved images.
Search : click [Search] to Search saved images.
Reset : click [Reset] to reset the setting.
Update : click [Update] to update images.
Create Slide Show.. : click [Create Slide Show] to create a Slide Show.
Always start on this page : If you select this option, the program will start in [Organize].





HOW TO USE THE SOFTWARES

MGI PhotoSuite III SE

► Creating an Album

1 To create an Album, click the large Organize button on the Welcome screen, or the Organize button on the Navigation bar.

2 Click [Album..] in ① Choose a photo album to view or edit.

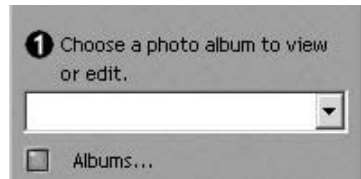

3 The Master Album window will be displayed, then click [New..].



4 Put a new Album name in the New Album window and click [OK]. A new album will now be created.





HOW TO USE THE SOFTWARES

MGI PhotoSuite III SE

SHARE

► Saving images

1 Saving or sharing images.

■ Menu of [SHARE] step

. Save

To save the active file according to its current name and path.

. Save As

To assign a new name or path to the file.

. Send E-mail

e-mailing images.

. Slide Show

Viewing images as a slide show.



2 Click [SAVE] and the Save Project window will be displayed. Enter the file name and click [Save] to save an image.





HOW TO USE THE SOFTWARES

MGI PhotoSuite III SE

PRINT

► Printing images

1 You can print images.

■ Menu of [PRINT] step

• Print

Printing images.

• Print Multiples

Print multiple copies of a photo or project, or one copy of each of the photos included in an album, according to a predefined template.



2 Choose a printer, choose an orientation, choose the print size, choose the number of copies. You can then print the images.



Reference

For more information, please refer to the Help file in [Help → MGI PhotoSuite III help].



REMOVING THE USB DRIVER FOR WINDOWS

Removing USB Driver for Windows

1 Click [Add/Remove programs] in Controller.

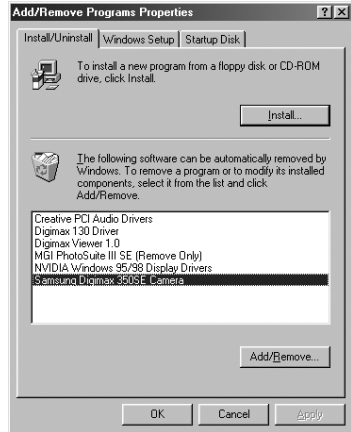

2 After selecting [Samsung Digimax 350SE Camera], click [Add/Remove] and the following window will display.

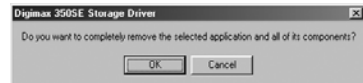

3 Click [OK] and USB driver will be removed automatically.



REMOVING THE USB DRIVER FOR WINDOWS



Reference

If you are a Windows 2000/ME/XP user, follow the procedure below to remove the USB Driver.

1. Connect the PC to the camera (PC mode, power on)
2. As mentioned above, remove [Samsung Digimax 350SE Camera] in [Add/Remove programs]
3. Click [Unplug or Eject Hardware] icon on the task bar. Click [Stop] on the [Unplug or Eject Hardware] window and click [OK] on the next window.



4. Click [System] on Control Panel.
Trace [Device Manager → Universal serial bus controller → Samsung USB Mass Storage Device] and click the right mouse button. Then the following window will be displayed. Click [Remove] to remove the USB Driver. Restart the computer





CONNECTING THE CAMERA FOR MAC

Connecting USB cable to camera for macintosh

- The USB port has to be in the Macintosh or keyboard.

- 1 Connect the USB cable to the USB port on the Macintosh.
- 2 Connect the other end of the USB cable to the USB port of the camera
- 3 Set the mode dial ().
- 4 Switch the camera on.





HOW TO INSTALL AND USE THE USB DRIVER FOR MAC

Setting up USB Driver for MAC

- 1 USB Driver for MAC is not included with the Application CD as MAC OS support the camera driver.
- 2 Check MAC OS
This camera is available in MAC OS 9.X or later.



Note

Before connecting camera to MAC, check that CF CARD is inserted in the card slot

- 3 Connect the camera to the Macintosh and turn the camera power on in PC mode.
- 4 A new icon (Untitled) will be displayed on the desktop after connecting camera to MAC.

Using USB Driver for MAC

- 1 Double click a new icon (Untitled) on the desktop and the folder in the CF CARD will be displayed.
- 2 Select image file and copy or move it to MAC.



FAQ

About USB

- Please check the following if the USB connection malfunctions.

[Case 1] The camera power is off.

→ Turn the camera power on.

We recommend using an AC power adapter in PC mode. If you use batteries, check the battery condition.

[Case 2] The mode dial is not set to PC mode.

→ Rotate the mode dial to PC mode.

PC interfacing is available only in PC mode.

[Case 3] USB Driver is not installed correctly.

→ Install the USB Driver correctly. Refer to page 90

[Case 4] The USB cable is not connected or you are using a cable with an incorrect specification.

→ Use a USB cable with the correct specification.

[Case 5] The CF CARD is not inserted or the camera can't recognize the CF CARD.

→ Turn the camera power off and insert the CF CARD again.

[Case 6] Occasionally the computer recognizes the USB as another device.

→ Install the camera driver correctly.

Turn the camera power off and remove the USB cable.

Connect the USB cable again and turn the camera power on.

Then the computer will recognise the camera.



FAQ

About USB

[Case 7] There is an unexpected error during file transfer.

- Turn the camera power off and on again. Then transfer the file again.

[Case 8] How do I know my computer supports USB Interface?

- Check the USB port in your computer or keyboard.
- Check OS version. USB Interface is available in Windows 98, 98SE, 2000, ME .XP.
- Check [Universal serial bus controller] in Device Manager.

Do the following to check [Universal serial bus controller].

Win 98/ME : Trace [start → setting → controller → system → Device Manager → Universal serial bus controller].

Win 2K : Trace [start → setting → controller → system → Hardware → Device Manager → Universal serial bus controller].

Win XP : Trace [start → Control Panel → Performance and Maintenance → system → Hardware → Device Manager → Universal Serial Bus controller].

There must be USB Host Controller and USB root hub under [Universal serial bus controller].

- When all the conditions mentioned above are met, the computer can support the USB interface.

[Case 9] When using USB hub.

- There may be a problem in connecting the camera to the PC through the USB hub if the PC and the hub are not compatible. Wherever possible, connect the camera to the PC directly.

[Case 10] Are other USB cables connected to the PC?

- The camera may malfunction when it is connected to the PC with another USB cable. In this case, disconnect the other USB cable, and connect only one USB cable to the camera.



SAMSUNG TECHWIN CO., LTD.
OPTICS & DIGITAL IMAGING DIVISION
145-3, SANGDAEWON 1-DONG, JUNGWON-
GU, SUNGNAM-CITY, KYUNGKI-DO, KOREA 462-121
TEL : (82) 31-740-8086, 8088, 8090, 8092, 8099
FAX : (82) 31-740-8398, 8399

SAMSUNG OPTO-ELECTRONICS AMERICA, INC.
HEADQUARTERS
40 SEAVIEW DRIVE, SECAUCUS, NJ07094
TEL : (1) 201-902-0347
FAX : (1) 201-902-9342

WESTERN REGIONAL OFFICE
18600 BROADWICK ST.,
RANCHO DOMINGUEZ, CA 90220
TEL : (1) 310-537-7000
FAX : (1) 310-537-1566

SAMSUNG OPTO-ELECTRONICS UK LTD.
SAMSUNG HOUSE, 3 RIVERBANK WAY,
GREAT WEST ROAD, BRENTFORD,
MIDDLESEX, TW8 9RE, U.K.
TEL : (44) 20-8232-3280
FAX : (44) 20-8569-8385

SAMSUNG OPTO-ELECTRONICS GMBH
SAMSUNG HAUS
AM KRONBERGER HANG 6, 65824 SCHWALBACH,
GERMANY
TEL : (49) 6196-66 53 03
FAX : (49) 6196-66 53 66

SAMSUNG FRANCE S.A.R.L.
BP 51 TOUR MAINE MONTPARNASSE 33,
AV .DU MAINE 75755,
PARIS CEDEX 15, FRANCE
TEL : (33) 1-4279-2282/5
FAX : (33) 1-4320-4510

SAMSUNG TECHWIN MOSCOW OFFICE
KORP. 14 37-A LENNINGRADSKY PRO-KT
MOSCOW, 125167, RUSSIA
TEL : (7) 095-258-9296, 9298, 9299
FAX : (7) 095-258-9297

TIANJIN SAMSUNG OPTO-ELECTRONICS CO.,LTD.
7 PINGCHANG ROAD NANKAI DIST., TIANJIN
P.R CHINA
POST CODE:300190
TEL : (86) 22-2761-8867
FAX : (86) 22-2761-8864

* Internet address - <http://www.samsungcamera.com/>

 The CE Mark is a Directive conformity mark of the European Community (EC)

6806-1234