

Advanced PureAir
state-of-the-art air purifiers

NEWPORT 9000

A I R P U R I F I E R



Owner's Manual

Please read and fully understand this manual before operating your NEWPORT 9000.

SAFETY OPERATION

Please exercise caution when using the Newport 9000 or any other electrical device! This manual describes the safety precautions which should be observed in relation to your air purifier. Please review carefully **BEFORE** using the product.

SPECIAL ATTENTION



RATED
VOLTAGE

The voltage rating for air purifiers sold in the USA, Japan and Canada is AC100-120V, 50/60Hz and in Europe is AC 230V, 50Hz. Using the wrong current may result in unit damage, electrical shock or fire.



DO NOT
DISMANTLE

Do NOT attempt to dismantle, repair or modify this device on your own. Doing so could result in electrical shock or damage to the unit. In the event of malfunction, contact an authorized maintenance facility.



AVOID HEAT
SOURCES

Do NOT operate your air purifier in places where flammable, explosive or otherwise combustible materials are stored.



AVOID
DIRECT
SUNLIGHT

Do NOT place the unit in direct sunlight or near lit fireplaces, furnaces, ovens or other high temperature objects. Doing so can damage the air purifier and may pose a fire hazard. Avoid operating the unit when the air temperature exceeds 104 F/40 C.



DO NOT
TAMPER

Do NOT place foreign objects in air purifier which can damage the unit or result in electrical shock. To avoid machine damage, injury and accidents, Do Not allow children to touch or play with this device.



DAMAGED
CORD

If the electric cord is damaged in any way, it must be replaced by the manufacturer or a qualified service center. NEVER operate a unit with a damaged electric cord. Doing so presents a serious risk of fire and/or electrical shock.



KEEP AWAY
FROM WATER

To prevent the possibility of electrical shock or short-circuiting your air purifier, Do NOT place the unit in or near the shower, bathtub or other places where water seep into and damage the unit.



DON'T
COVER

Do NOT operate your air purifier while it's covered with fabric, plastic or other materials. This can obstruct air flow, damage the unit and may pose a fire hazard.



AVOID
DISTORTION

To avoid distortion or interference, your air purifier should be placed at least three (3) feet from computers, televisions and radios.



WHEN TO
UNPLUG

For safety reason and to avoid the risk of electrical shock and/or fire, unplug your air purifier from the electrical outlet under each of the following conditions

- When cleaning or servicing the air purifier or replacing filters.
- When you will not be using your air purifier for an extended time period.
- When moving the unit from one location to another.

WARNING: The Newport 9000 is equipped with a polarized plug, i.e., one blade is wider than the other. The polarized plug is a safety device to reduce the risk of fire, shock and personal injury and is intended for use in a polarized outlet. The plug will fit only one way in a polarized outlet. Insert the wide blade of the plug into the wide slot of the outlet. If the plug does not fully fit into the outlet, reverse the plug. Never force the plug into any socket or try to defeat this important safety feature in any way. If it still does not fit contact a qualified electrician. Do not remove, replace, repair or in any way tamper with the original plug supplied with this unit.

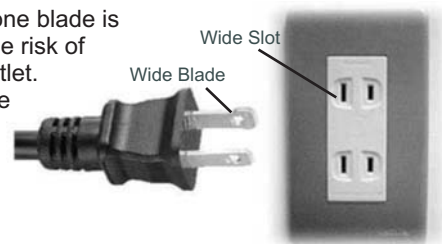

CONTROLS & AIR FLOW VENTS

Front Face Plate

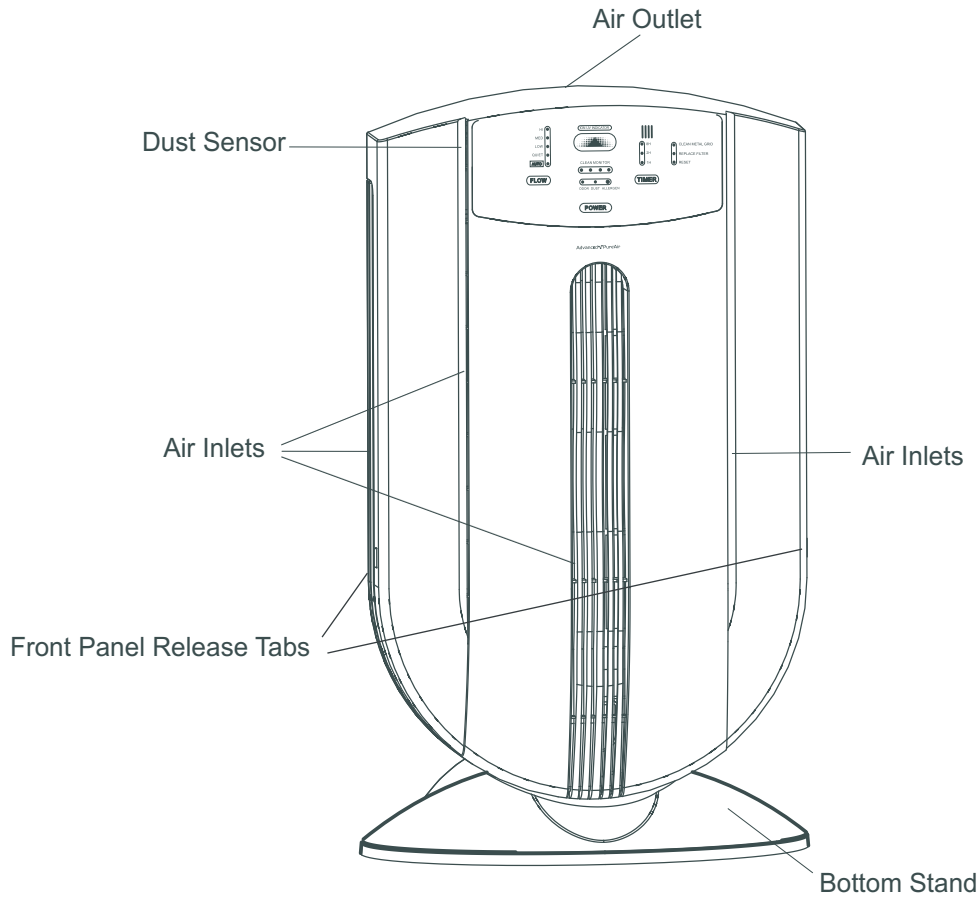

Soft Touch Control Panel

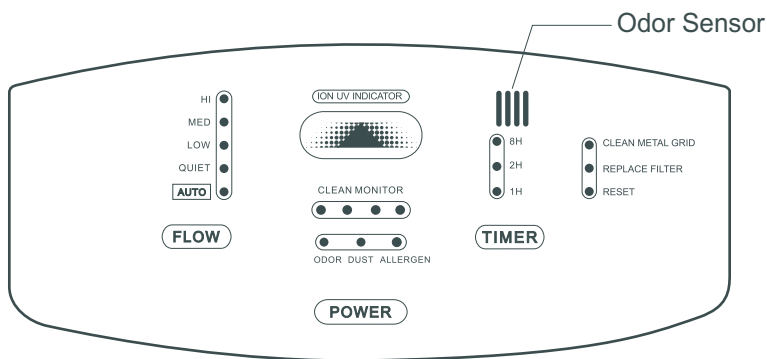

Remote Control

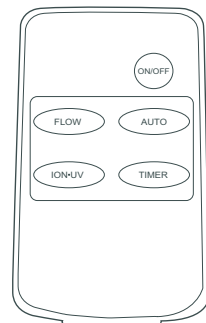

MAJOR COMPONENTS

Back View



Exploded Parts View

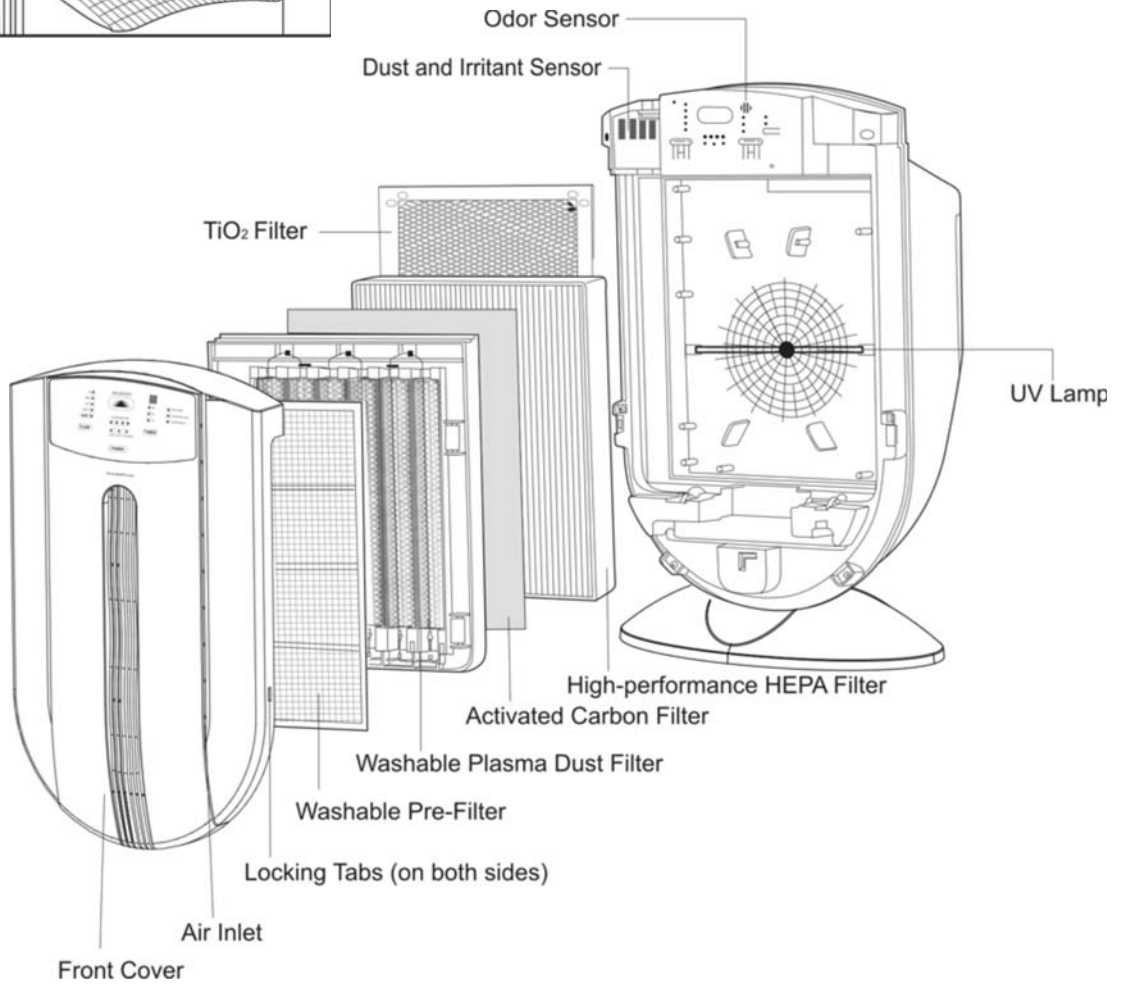

BEFORE USE

Pre-Installation Air Ventilation

- Before plugging in the unit, please open the windows in the area where you will be using the unit. Ventilate the area for 2-3 hours if possible. Once the area has been ventilated, close the windows and plug in the unit.

Open Windows for Air Ventilation

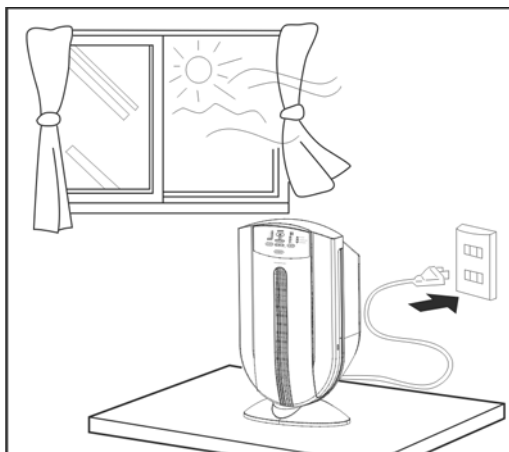

- After plugging in, the unit sensor will sample the air and retain a memory of the existing indoor air condition. (The existing indoor air condition will be input as "CleanAir").
- Once started, the odor indicator will blink as it memorizes the existing fresh air condition. After two minutes, the indicator will stop blinking to indicate the end of memorization.
Please Note: Whenever the unit is unplugged, all memorized content will be erased.
- If the unit is turned on two minutes after plugging it in, the odor sensor indicator will not blink.
- When smoke, cosmetics, or any spray that contains alcohol is present, please ventilate and freshen the air before closing windows.
- Sometimes the sensor is not as sensitive when first purchased or after being unplugged for over a week. Its sensitivity will begin to increase after one to two days of operation.

EXPLANATION OF INDICATORS

Negative Ion Indicator

- During the process when negative ions are generated, the blue indicator on the Soft Touch Control Panel will gradually change from bright to dim and from dim back to bright every 5seconds.

Odor Indicator

- The odor indicator on the Soft Touch Control Panel will glow whenever the odor sensor detects odor (such as indoor smoke).

Dust and Irritant Indicator

- The dust-and-irritant indicator on the Soft Touch Control Panel will glow whenever dust or other irritants are detected.

Air Quality Surveillance

- Whenever odor, dust, or irritants are detected, the air quality surveillance function will indicate the level of pollution on the Soft Touch Control Panel. When pollution is severe, all the LED's will glow.

LED Examples for Air Quality Surveillance



No pollution detected



Some pollution detected



Severe pollution detected

OPERATING INSTRUCTIONS

Locate the Unit

- Place the Newport 9000 against a wall, near an electric outlet with 12-15 inches clearance on the front and sides. It is best to place the unit where it will be out of any children's play area.

How to Start

- Plug the unit into a standard 120V/60Hz outlet. Press the POWER ON/OFF button. The device starts operating automatically and the negative-ion UV indicator will automatically turn on. Press POWER ON/OFF again and the device will turn off.

Fan Modes

- This Newport 9000 has five different fan modes to choose from. Please choose a proper level of circulation according to indoor air quality and room size. As you press FAN, the fan mode will change according to the number of times you press the button. The LED will show the following sequence of modes:



Automatic Operation

- Keep pressing the FAN button until the device runs under automatic operation (the LED will show AUTO).
- Under automatic operation, the device automatically switches to the proper running modes (MED or LOW) according to the level of odor, dust, or irritants in the air as detected by the sensor. As the air is purified, the device will automatically switch back to LOW or QUIET modes.

Timed ON/OFF

- Press AUTOTIMER button to set operation timing.
- Under the AUTOTIMER function, the operation timing will be set according to the number of times you press the AUTOTIMER button. The LED will show the following sequence of timing:



CLEANING AND MAINTENANCE

- Before starting any cleaning or maintenance, always turn-off and unplug the unit.
- Regular cleaning and maintenance is recommended every 2-3 months.

Disassembling the Newport 9000

- After unplugging, carefully lay the unit down face-up. Disassemble the unit in sequence of 1 to 5 as shown below. (Put the unit back together in the reverse 5 to 1 sequence.)

1. Remove the Front Face Plate

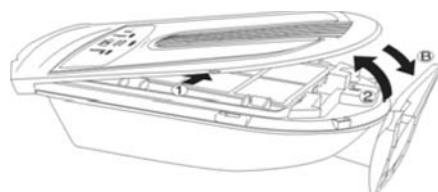

- ① Press the locking tabs on both sides of the device
- ② Gently lift up the front cover

When assembling

- ③ Firmly reconnect the front cover back to its original position
- ④ Make sure the two locking tabs reattached immovably

- ⓐ Please attach firmly at the connecting locations



2. Remove the Washable Pre-Filter

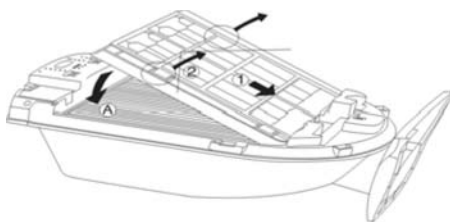

- ① Push the plasma dust collector towards the bottom of the device
- ② Hold the two tabs and lift up the dust collector

When assembling

- ③ Push the plasma dust collector towards the bottom of the device
- ④ Insert into position A

3. Remove the Washable Plasma Dust Filter

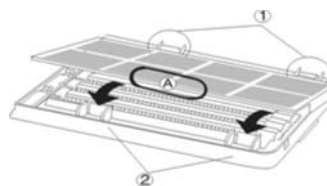

- ⓐ Hold position A and lift up the front filter

When assembling

- ① Attach the filter to the connecting locations on the side
- ② Fasten the filter on the front connecting locations

4. Remove the HEPA/Activated Charcoal Filter

Do not reverse the front and back of the filter

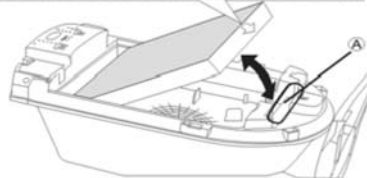

- ⓐ Reach your hand into position A and pull out the filter. When replacing filter, please install the filter with the exact front-and-back direction as indicated on the sides of the filter. Do not reverse the front and back of the filter.

5. Remove the TiO2 Filter

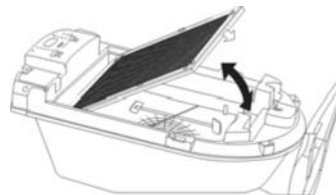

- ⓐ Hold the clips of both sides to help pulling out the filter.

CLEANING AND MAINTENANCE (CONT.)

Regular Cleaning and Maintenance

Dust sensor cover

- Use a slightly moisten cloth to wipe dust off the sensor cover.

TiO₂ Filter

- Use a vacuum cleaner to eliminate dust on the filter

HEPA Filter

- Use a vacuum cleaner to eliminate dust on the filter
- Note: If the HEPA filter is dark grey or black with pollutants it is advised you contact Real Spirit USA for replacement filter.

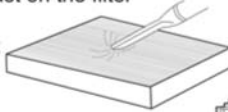

Washable Plasma Grid Filter

and

Washable Pre-Filter

- Can be cleaned with flowing water
- Do not clean with hot water

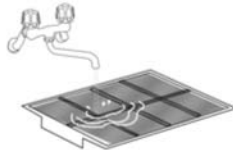

Front Face Plate

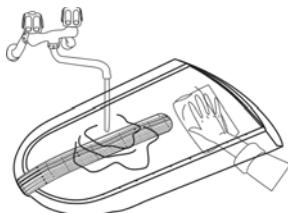

- Can be cleaned with flowing water
- Please use a soft cloth to clean and avoid scraping off the paint on the cover
- Avoid cleaning with hot water or rubbing too hard or paint damage or deformation could occur.

For Instructions regarding the disassembly of the face plate and filters refer to page 7.

Unit Body

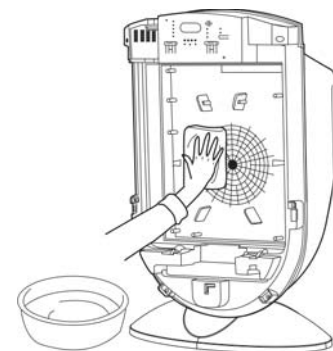

- Take down UV lamp before cleaning
- Use wring dry cloth to rub and clean.

CLEANING AND MAINTENANCE (CONT.)

Cleaning and Maintenance of the Washable Plasma Dust Filter

The Washable Plasma Dust Filter needs cleaning when:

- 1) The cleaning indicator is glowing or blinking.
- 2) The dust collector is making electrical discharge sounds.
- 3) The device has been used frequently in an area with lower air quality condition.

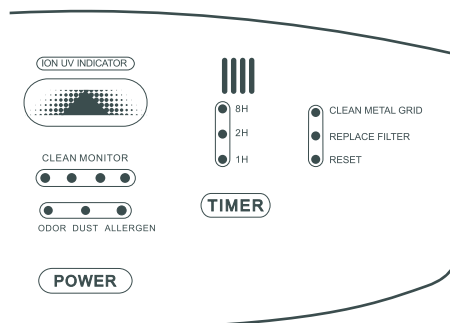

Cleaning Instructions

1. Remove the Front Face Plate.
2. Remove the Washable Pre-Filter.

Please refer to page 7 for detailed instructions on the removal of the Front Face Plate, Washable Pre-Filter and the Washable Plasma Dust Filter.

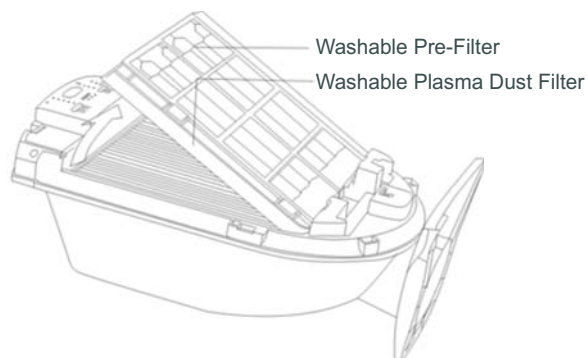

3. Remove the Washable Plasma Dust Filter

Note: Please wear protective gloves to avoid cutting or scratching your hands.

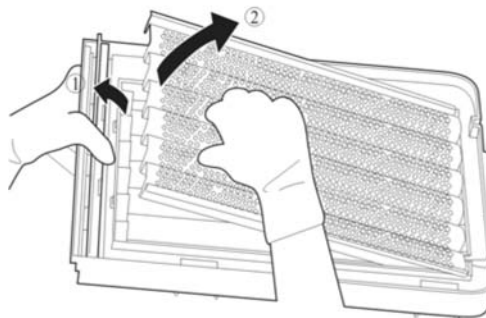

CLEANING AND MAINTENANCE (CONT.)

The Cleaning and Maintenance of the Washable Plasma Dust Filter (Cont.)

4. Clean the Plasma Dust Filter

- Use mild detergent or plain water only.
- Use a soft scouring pad or toothbrush to clean the dust collector.
- Use warm water (below 40° C) only!

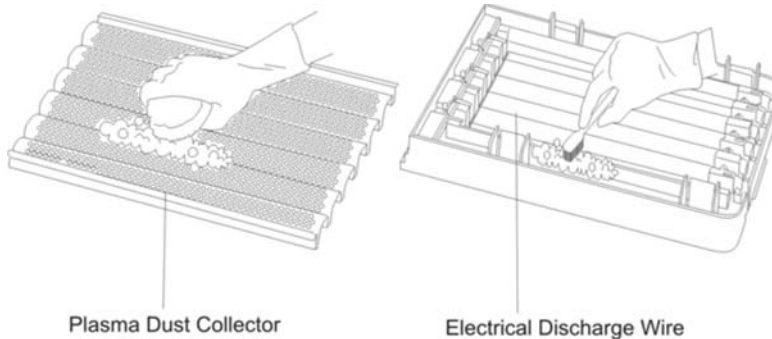

5. If dust and dirt does not wash away easily, pre-soak with diluted detergent and then use a toothbrush to scrub.

- Please take care not to damage any wiring while cleaning the dust collector. If any electrical discharge wire is broken, the device will lose part or all of its dust collecting capability.
- Any broken wire should be thrown away instead of being left inside the unit. Otherwise, a dangerous short-circuit or high-voltage sparks may occur. Please contact info@realspiritusa.com for additional electrical discharge wire.
- Please do not clean using acidic or alkaline detergent that can create rust on the surface of device.

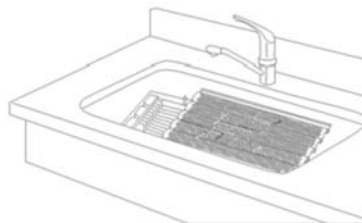

6. Thoroughly dry all washed parts.

- After cleaning, please completely dry the unit before use. Operating a wet unit may cause electrical shock or malfunction.
- If the front cover of the plasma dust collector is not properly installed, the unit will not function.
- Please make sure the plastic wrap for the electrical discharge wire is located in its proper position.

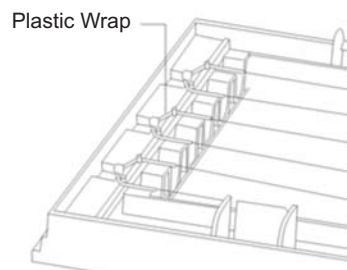

CLEANING AND MAINTENANCE (CONT.)

Replacing Filters

- Please change filter when the REPLACE FILTER indicator is glowing.

Note: Please refer to page 7 for instructions on filter installation and removal.

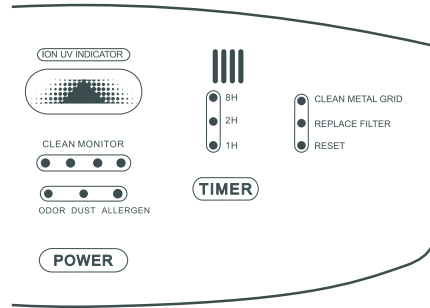

Replacing UV Lamp

- The life span of UV lamp is about 5,000 hours. Replace UV lamp when it is damaged or when no blue light is observed.
- Remove the Front Face Plate, Washable Pre-Filter, Washable Plasma Dust Filter, and HEPA/Charcoal filter before replacing the UV lamp (refer to page 7 on how to disassemble).
- Softly twist the UV lamp, remove the lamp from its position, and insert a lamp tube of the same model.

Resetting the CLEAN METAL GRID and REPLACE FILTER Indicators

After cleaning and replacing filters, reset the CLEAN METAL GRID and REPLACE FILTER indicators.

Otherwise the two indicators will remain on after servicing the unit.

The unit must be plugged but turned off to reset the CLEAN METAL GRID and REPLACE FILTER indicators.

The RESET button is inside the unit (cannot be reached with finger).

Please use a toothpick, straightened paper clip or other similar shaped object to push the RESET button.

How to Reset:

1. CLEAN METAL GRID Indicator

- When the unit is plugged in, but turned off, the resetting process for the CLEAN METAL GRID indicator is done by pushing both the RESET and the TIMER buttons at the same time.

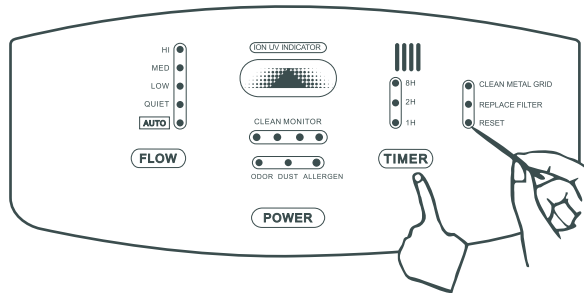

2. REPLACE FILTER Indicator

- When the unit is plugged in, but turned off, the resetting process for the REPLACE FILTER indicator is done by Pushing both the RESET and the FLOW buttons at the same time.

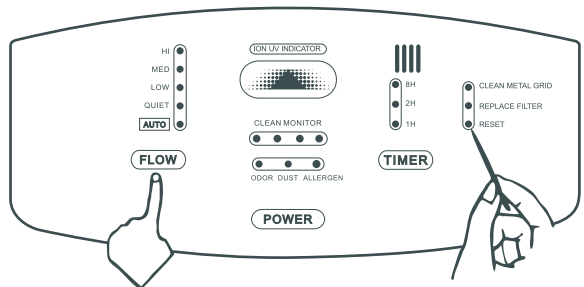

FREQUENTLY ASKED QUESTIONS

Air Quality Surveillance

Why is there is only one LED glowing all the time with the air quality surveillance function?

- Indoor air has been clean the whole time.
- For testing purpose, dust either caused by a cigarette or a dusty cloth can be released near the irritant sensor. If the level of pollution goes up, then the unit should be operating properly.
- The irritant sensor could be too far away from any irritant for it to detect. Please move the unit closer to your major sources of pollution

Why does the air quality surveillance indicator always have two LED glowing?

- Possibly because the room is not really a closed environment and pollution keeps coming in from the outside. Or, because there has been pollution created indoors (e.g. smoking/pet boxes etc.) the whole time. It will take some time for the Newport 9000 to achieve a clean environment with only one indicator LED on.

Why does the air quality surveillance function keep switching back and forth frequently?

- Sometimes the Irritant Sensor is affected by cell phone or other wireless equipment. When using cell phone or other wireless equipment, please stay away from the unit.

Dust and Irritant Sensor

Why does the Dust and Irritant Sensor keep blinking?

- In some locations the top of the sensor will accumulate more dust than in others Locations, This will decrease the efficiency of the sensor. (Please refer to page 8 for the cleaning of the sensor.)

Odor Sensor

Why doesn't the Odor Sensor work?

- In the initial set-up of the unit the Odor Sensor did not get properly trained. Please retrain the sensor memory. (Please refer to page 4 on details under Before Use).
- When first purchased or when the unit has been unplugged for more than a week, the sensor will not be as sensitive. After 1 to 2days of operation, the sensor will regain its sensitivity.

FREQUENTLY ASKED QUESTIONS (CONT.)

Filter

Why is it so hard for the filter to get rid of dust and odors?

- Have the front and back of the HEPA/Charcoal filter been mistakenly reversed?
- The HEPA/Charcoal filter has been saturated with a serious amount of dust. (Usually dark grey in color). Please replace filter.

Plasma Dust Collector

Why is it so difficult to eliminate dust and odor?

- If the electrical discharge wires or the plasma dust collector gets too dirty. Please refer to page 10 on how to clean and maintain.
- If an electrical discharge wire been disconnected or broken? Contact info@realspiritusa.com for additional information and parts.

Cannot Turn On the Unit

Why is the unit not working even after turning it on?

- Has the plug been loosened or disconnected from the socket? Please check that the plug is properly plugged in to an outlet.
- Has the unit been properly reassembled after being cleaned? Please confirm. The unit will not operate if the Washable Plasma Dust Filter or the Front Face Plate have not properly installed.

APPLICABLE AREAS

The unit is designed for any indoor room or living space up to 80 square meters or over 800 square feet. It can be used in living or family rooms, bedrooms, offices, studios, waiting rooms, hotels, hospitals, etc.

If the unit is to be used in a smaller room, you may prefer to have the power setting on medium or low.

TECHNICAL SPECIFICATIONS

Real Spirit Style No.: Newport 9000

Rated Voltage: AC 120V/60Hz

Power Consumption: 80W

Ion Output: $\geq 2 \times 10^6/\text{cm}^3$

Activated Oxygen Output: ≤ 0.05 ppm

UV Spectrum: $\geq 20\mu \text{ w/cm}^2$ at 10 cm distance.

Dust Removal Rate: 1 micron 99.97% • 0.3 micron 80%

Noise Level (dB): Quiet 20 • Low 35 • Med 45 • High 52

Air Volume (High): 3 m³/min. • 106 ft³/min.

Dimensions: 13.5" x 10" x 25.6" • 343 x 255 x 610 mm

Weight: 15.1 lbs • 6850 g

Applicable Area: 80 m² • 861 ft²

PRODUCT SERVICING

In case of any malfunction, contact your retailer or email us at info@realspiritusa.com..

PRODUCT WARRANTY

- Advanced PureAir warrants the Newport 9000 air purifier to be free from manufacturing and material defects (excluding filters, lights, and batteries) for a period of one year from the original date of purchase.
- This warranty is valid only to the original owner with proof of purchase.
- Product abuse, misuse, modification, alteration, or opening of the unit housing, other than as required for filter replacement or routine maintenance and cleaning, will void the warranty.

Advanced PureAir

state-of-the-art air purifiers

Produced and distributed exclusively by:



Real Spirit USA, Inc. • 9447 De Soto Ave • Chatsworth, CA 91311
Customer Service Phone 888.698.2080, ext. 210
www.AdvancedPureAir.com • info@RealSpiritUSA.com

© Copyright Real Spirit USA, Inc. 2008. All Rights Reserved
Manufactured in China