

SEARS

**OWNER'S
MANUAL**

MODEL NO.
274.42798390
SERIES

Record the Model No. and the
Serial No. of your television in
the space provided.

Model No. _____

Serial No. _____

Keep this information for
future use.

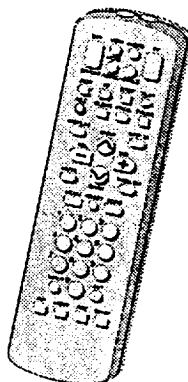
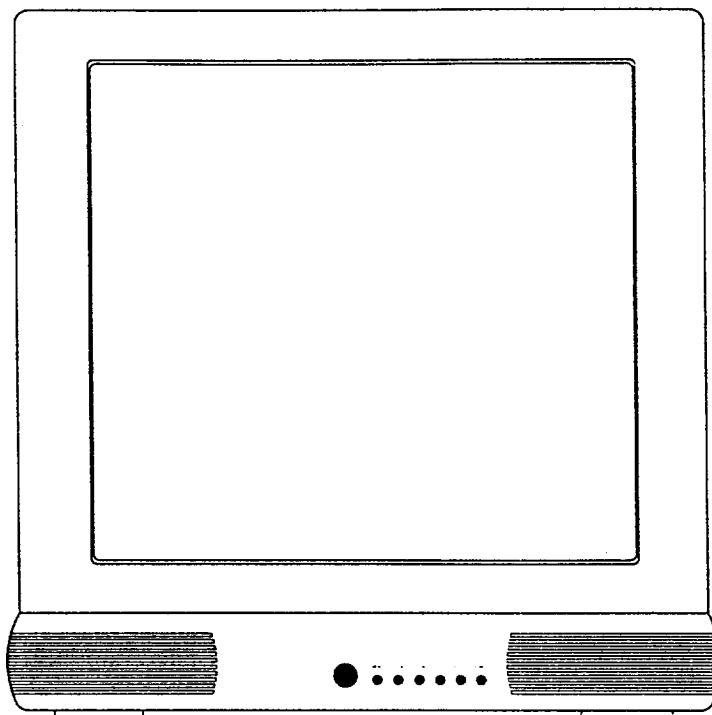

**SEARS
27" TABLETOP
COLOR TELEVISION
WITH REMOTE CONTROL**

**Safety Information
Use
Warranty and Service**



L38-13836-0

Important Information

WARNING

To prevent fire or shock hazard, do not expose this TV to rain or moisture.



WARNING RISK OF ELECTRIC SHOCK DO NOT OPEN	TO REDUCE THE RISK OF ELECTRIC SHOCK, DO NOT REMOVE COVER (OR BACK). NO USER SERVICEABLE PARTS INSIDE. REFER SERVICING TO QUALIFIED SERVICE PERSONNEL.
 This symbol indicates "dangerous voltage" inside the product that presents a risk of electric shock or personal injury.	 This symbol indicates important instructions accompanying the product.

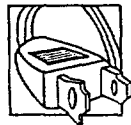

To prevent electric shock, match wide blade of plug to wide slot, fully insert.

Pour éviter les chocs électriques, introduire la lame la plus large de la fiche dans la borne correspondante de la prise et pousser jusqu'au fond.

Cautions



Do not defeat the safety feature of the plug. The wide blade fits into the wall socket only one way. If you need an extension cord, make sure it matches the plug of the TV.

Operate TV only on 120 volts, 60 Hz AC power (normal house power).

For safety reasons, make sure any equipment or accessories connected to this product bears the UL listing mark or CSA certification mark. If in doubt, contact qualified service personnel.

FCC Regulations state that unauthorized changes or modifications to this equipment may void the user's authority to operate it.

Note To Cable TV Installer

This reminder is provided to call your attention to Article 820-40 of the National Electrical Code (Section 54 of the Canadian Electrical Code, Part 1) which provides guidelines for proper grounding and, in particular, specifies that the cable ground shall be connected to the grounding system of the building as close to the point of cable entry as practical.

Table of Contents

Important Information	Warning, Product Registration _____	i
Quick Guide to Your TV	Startup _____	2-3
	Hook up your TV, Plug in the TV, Put Batteries in the Remote, Turn on the TV, Place Channels into Memory, Set the Time	
	Tour of the Remote _____	4
	Basic Button Layout and Functions	
	Guide to the Menus _____	5
	Colors, Menu Buttons, Moving through the Menus	
Using Your TV and Remote	With Remote Buttons _____	6-7
	With VCRs _____	8-11
	With a Cable Box _____	12-13
	With a Laserdisc _____	14
	With Audio Equipment _____	15
Adjusting Your TV	Overall Picture _____	16
	Picture Settings _____	17
	Color, Tint, Brightness, Sharpness, Autocolor, Picture Reset	
	Sound Settings _____	18-19
	Stereo, Tone, Speakers	
Using Advanced Features	Place Channels in Memory / Autoprogram _____	20
	Naming Channels _____	21
	Setting the Sleep Timer _____	22
	Setting the Alarm Clock _____	23
	Watching Picture-in-Picture _____	24-25
	Watching Closed Captioning _____	26
	Setting your TV for Antenna or Cable _____	27
References	With TV Buttons _____	28
	Displays on the Screen _____	29
	Trouble Checks _____	30-31
	Glossary _____	32
	Index _____	33

Quick Guide to Your TV

Startup

The steps below will get your TV connected and ready for watching.
For more details, see the page numbers listed.

1. Hook up your TV

Details are in the Connections Guide.

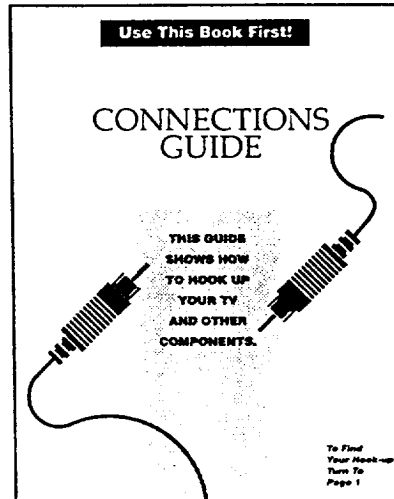

Hook up any antennas, cables or other equipment to your TV before you follow the steps below.

2. Plug in the TV

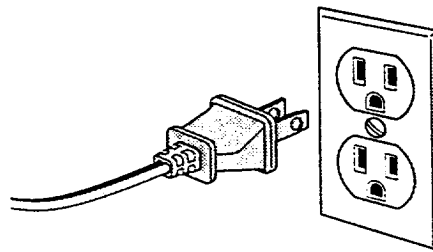

Plug the cord into the outlet, matching the wide and the small end of the plug with the outlet.

3. Put Batteries in the Remote

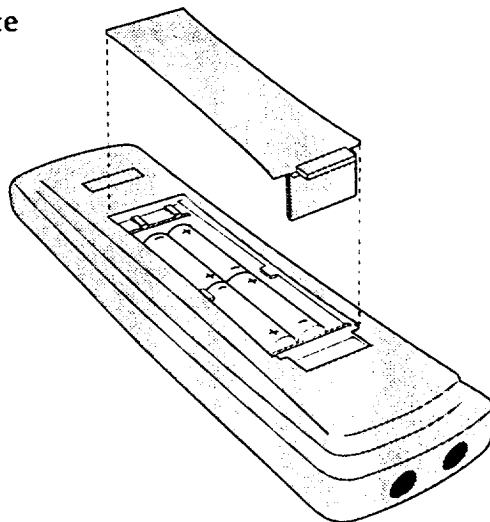

- Pull off the cover of the battery compartment.
- Place the four AAA batteries as shown, matching the + and - end of each battery in the compartment.
- Replace the cover.

Quick Guide to Your TV

Startup

4. Turn on the TV

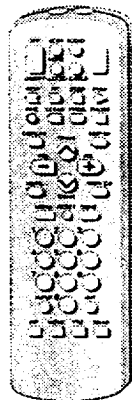

Press TV on the remote.

OR

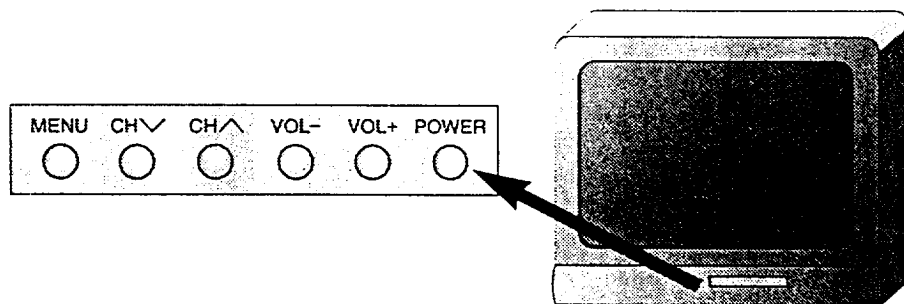

Press POWER on the TV.

5. Place all available channels in memory (Autoprogram)

Details for adding and deleting channels are on page 20.

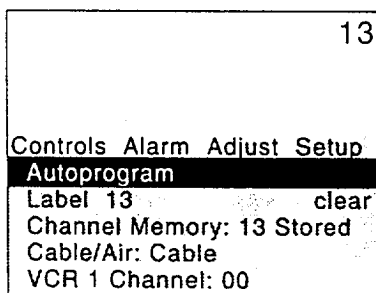

- A. Press MENU until the Setup menu is selected. This menu is white.
- B. Press + to start placing channels in the TV's memory.

6. Set the Time

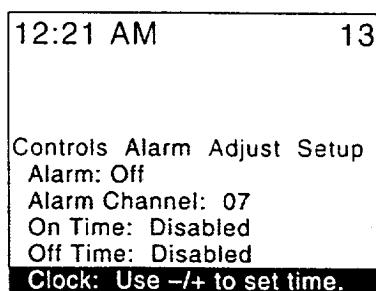

- A. Press MENU until the Alarm menu is selected. This menu is green.
- B. The Clock is automatically highlighted the first time you set it. If it is not, press CHANNEL down to highlight it.
- C. Press - to set the hour.
- D. Press + to set the minutes.
- E. Press DONE to save the setting.

Quick Guide to Your TV

Basic Tour of the Remote

Basic information about your remote is shown below. This will give you a general idea of how your remote works. *For more details, see pages 6–15.*

TV Power Button

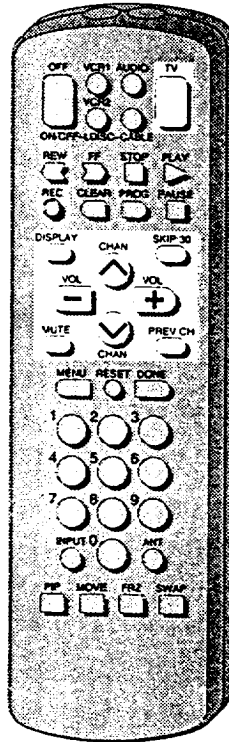

Turns the TV on.
Sets the remote to control the TV.

Volume and Channel Controls

Details are on page 6.

Operates TV when remote is set to control the TV.
Operates the TV and advanced features.

Component Buttons

Details are on pages 8–15.

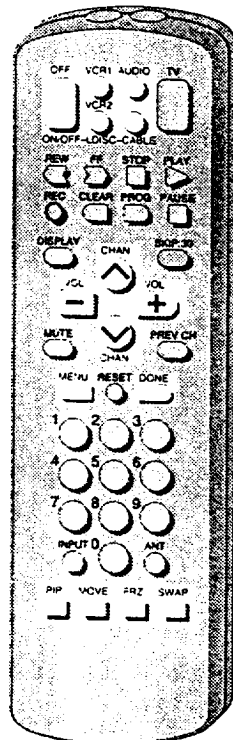

Controls components such as a VCR, laserdisc, audio equipment, and a cable box.

Menu Buttons

See next page for details.

Changes the menus and features on the screen.

Picture-in-picture buttons (Not on all models)

Details are on pages 7 and 24–25.

Used to watch two pictures on the TV at the same time.

Quick Guide to Your TV

Menu Basics

General information about using the on-screen menu system is shown below. *Details on using the remote buttons are on pages 6-7. Many menu items are explained in detail in Using the Advanced Features starting on page 20.*

Colors

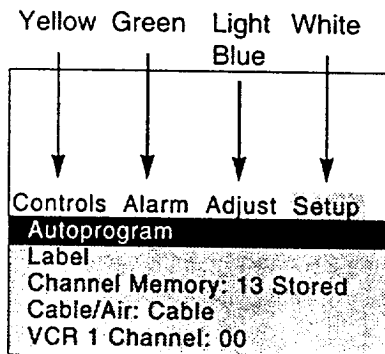

Press MENU repeatedly to see each of the four menu colors. Each menu has a different color background as shown at the left.

Menu Buttons

These buttons are used with the TV's menus to adjust the features. You can use the menu buttons on the remote or the front of the TV.

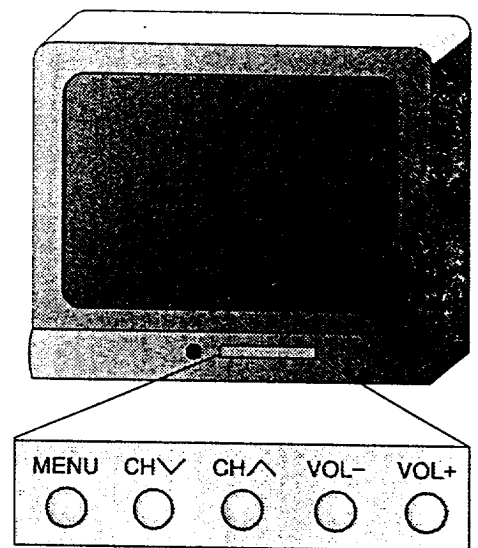
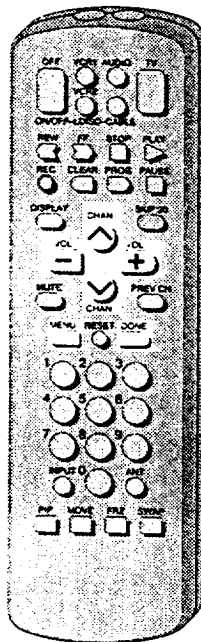

Moving through the Menus

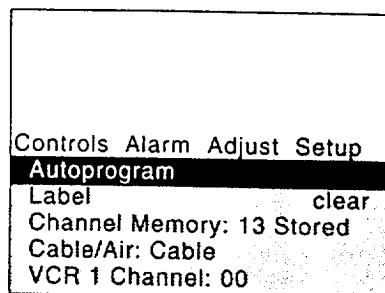

1. Press MENU to move from menu to menu
2. Press CHANNEL up and down to move up and down through the features in the menu
3. Press VOLUME + and - to move left and right on the menu lines

Using Your TV and Remote

With Remote Buttons

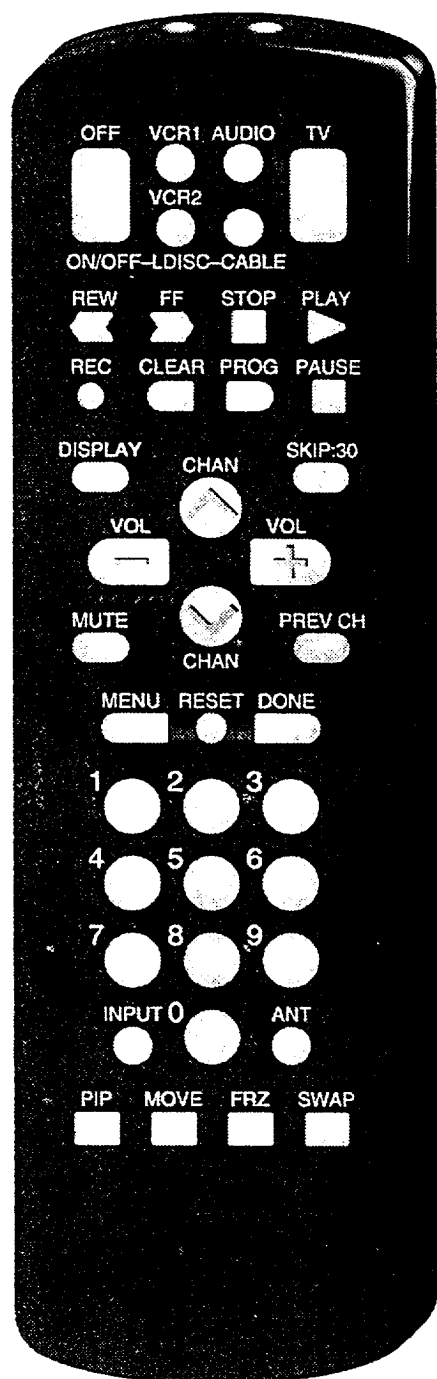

1. Power Buttons

OFF

Turns off the TV.

Turns off compatible VCRs.

ON/OFF

Turns on a component after a component button is pressed.

Turns off components except audio equipment.

TV

Turns on the TV.

Shows the displays on the screen.

Sets the remote to control the TV.

See Using the Remote with a VCR, Cable Box, Laserdisc Player and Audio equipment on pages 8-15.

2. TV Buttons

CLEAR

Clears menus and displays from the screen.

DISPLAY

Shows displays on the screen.

Clears menus from the screen.

SKIP:30 (Commercial Skip)

Allows you to scan other channels during commercials.

Each press adds 30 seconds. TV switches back to original channel when time runs out. Press CLEAR to cancel SKIP.

VOL (Volume)

Raises and lowers sound.

Moves left and right on a menu line. *See Quick Guide to the Menus on page 5.*

Changes a feature setting.

MUTE

Turns off the TV sound.

CHAN (Channel)

Scans up and down through channels in the TV's memory.

Moves up and down menus. *See Quick Guide to the Menus on page 5.*

Moves through channels in VCR's memory.

PREV CHAN (Previous Channel)

Changes back and forth between two channels.

Select a channel and then select another. Press PREV CHAN to switch between the two channels.

MENU

Shows menus on the screen and moves from menu to menu.

RESET

Returns the picture adjustments to the original settings.

DONE

Saves the setup of a feature and removes the menu from the screen.

3. Number Buttons (0-9)

Selects any channel number.

Two numbers must be pressed for each channel. Press 0 and 6 for channel 6.

For three digit channels, press and hold 1 until 1-- appears on the screen. Then press the other two numbers.

Using Your TV and Remote

With Remote Buttons

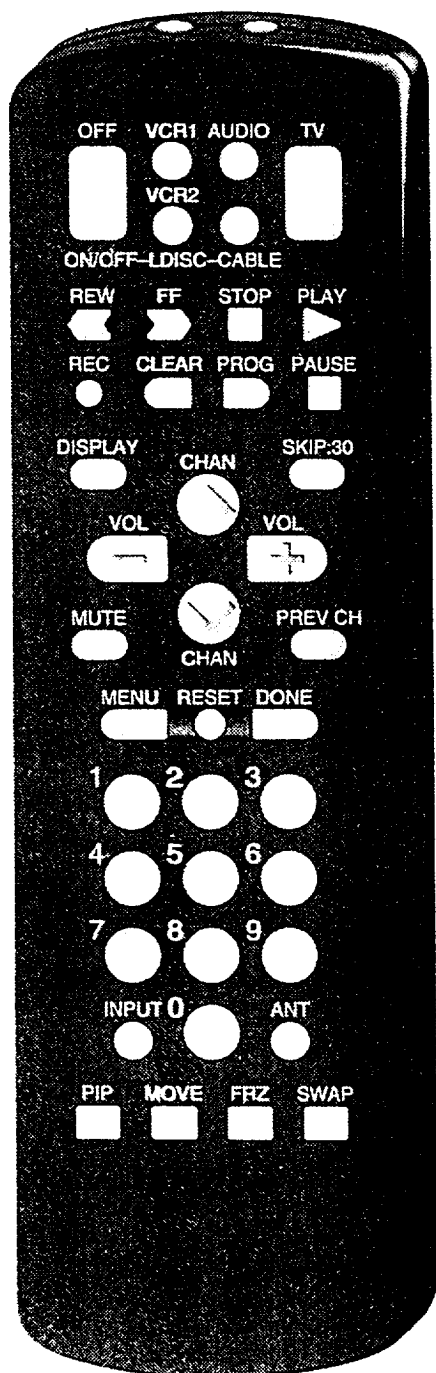

4. Component Buttons

AUDIO, VCR1, VCR2, LDISC, CABLE, TV

Sets the remote to control the component.

VCR2 and LDISC can only be programmed for one component: either a Laserdisc Player or a VCR.

See *Using the Remote with a VCR, Cable Box, Laserdisc Player and Audio equipment on pages 8-15.*

5. VCR, Laserdisc, and Audio Equipment Buttons

REW (Rewind)

Rewinds a tape or laserdisc.

Searches backward while tape or laserdisc is playing.

FF (Fast Forward)

Fast forwards a tape or laserdisc.

Searches forward while tape or laserdisc is playing.

STOP

Stops tape or laserdisc.

PLAY

Plays tape or laserdisc.

REC (Record)

Starts recording onto tape.

CLEAR

Clears items from timer programs and VCR's clock.

PROG (Program)

Sets clock and programs timer on VCR.

PAUSE

Pauses tape or laserdisc.

6. Signal Buttons

INPUT

Switches between the TV channels and Video 00/S-VID 00.

ANT (Antenna)

Used as TV/VCR button when remote is set to control the VCR.

7. Picture-in-Picture Buttons

PIP (Picture-in-Picture)

Turns the small picture on or off.

MOVE

Moves the small picture to the next corner.

FRZ (Freeze)

Freezes or unfreezes the small picture.

SWAP

Switches the channel in the small picture with the big picture.

Using Your TV and Remote

With VCRs: Programming the Remote

Refer to the Connection Book or the VCR's owners manual to hook up your VCRs. The remote may need to be programmed for your VCR. Use the codes below or on the sheet packed in with your remote.

1. Test the remote

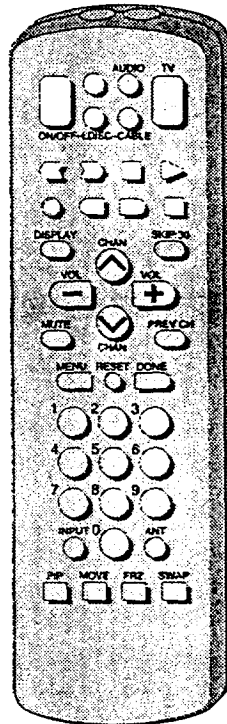

- A. Press VCR1 or VCR2 to turn the VCR on.
- B. Press the VCR buttons shown at the left. If your VCR does not work, program it with a VCR code from the list below.

2. Program the remote for your VCRs

- A. Point the remote at the VCR and hold VCR1 or VCR2.
- B. Enter the code for your brand from the code list below.
- C. Release VCR1.
- D. Press ON/OFF. If nothing happens, try pressing VCR1 and then ON/OFF.
- E. Repeat A-D with another code if the first one does not work or if a second VCR is connected.

VCR Codes

Aiwa	15	Lloyd	15	Sanyo.....	02,12
Akai	03,22,23	Magnavox	08,29	Scott.....	04,13,41
Audio Dynamics.....	14,16	Marantz	02,08,14,16,29,30	Sears	02,05,09,12,18,19,35,43
Broksonic	10	Marta	09	Sharp.....	06,24,39
Canon	08	MEI	08	Shintom	17,26,31
Capehart.....	01	Memorex	08,09,12,15	Sony.....	17,26,38
Citizen	09	MGA	04,27	Sylvania	08,15,29
Craig	07,12	Minolta	05,35	Symphonic	02,15
Curtis Mathes.....	00,08,15	Mitsubishi.....	04,05,27,35,40	Tashiko	09
Daewoo	13	Montgomery Ward.....	06	Tatung.....	30
dbx	14,16	MTC.....	07,15	Teac	15,30
Dimensia	00	Multitech.....	07,15,31,32	Technics.....	08
Dynatech.....	15	NEC	02,14,16,30	Teknika	08,09,15,21
Emerson	09,10,13,15,20,23,24,34,41	Panasonic.....	08	Toshiba	05,13,19
Fisher	02,12,18,19,43	Pentax	05,35	Totevision.....	07,09
Funai.....	15	Philco.....	08,29	Unitech	07
GE	00,07,08,32,37	Philips.....	08,29	Vector Research.....	14,16
Goldstar.....	09,14	Pioneer	05,16,33	Victor	16
Harman Kardon.....	14	ProScan.....	00	Video Concepts	14,16
Hitachi.....	05,15,35,36	Quartz.....	02	Videosonic.....	07
Instant Replay	08	Quasar	08	Wards	
JCL	08	RCA	00,05,07,08,28,35,37	05,06,07,08,12,13,15,25,31,35
JCPenney.....	02,05,07,08,14,16,30,35	Realistic.....	02,06,08,09,12,15,19,43	Yamaha.....	02,14,16,30
JVC.....	02,14,16,30	Samsung.....	07,13,22,32,42	Zenith.....	11,17
Kenwood.....	02,14,16,30	Sansui	16		

Using Your TV and Remote

With VCR: Setting the VCR1 Channel

The VCR 1 Channel works with VCR1 on the remote. If the VCR 1 Channel is set, pressing VCR1 selects the channel to see the VCR picture. The VCR 1 Channel setting depends on which diagram you have used from the Connection Guide. If you want to turn this feature off, set the VCR 1 Channel to Disable. Refer to the chart below for your setting.

1. Select the Setup Menu

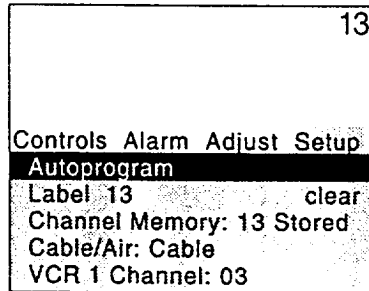

- A. Press TV to set the remote to control the TV.
- B. Press MENU to select the Setup menu. This menu is white.

2. Highlight VCR1 Channel

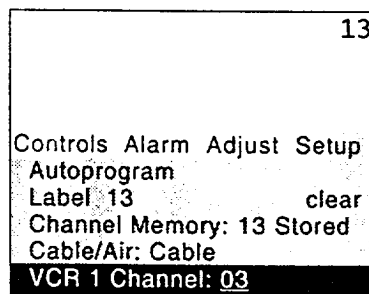

- A. Press CHANNEL down to highlight the VCR 1 Channel.
- B. Press + to highlight the channel.

3. Enter channel number

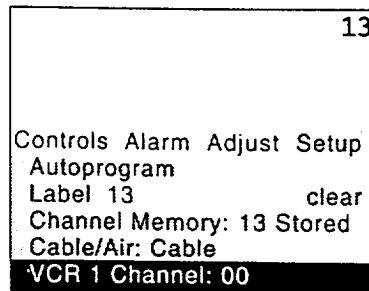

- A. Enter channel 00, 03, or 04. Choose your setting from the chart below. Press + if you want to turn this feature off (Disable).
- B. Press DONE to save the setting.

4. Press DONE to save the setting

Diagram used from the Connection Guide:	Set VCR1 Channel to:
1B, 1C, 2B, 2C, 3B, 3C, 4C, 5C	00
4B, 5B	3 or 4 (same as 3/4 switch)

Using Your TV and Remote

With VCRs: Basic Operation

If the remote operates your VCR, this page and the next will show you how to use it for basic functions. See page 7 for more details on buttons used with your VCR.

Turn on the VCR

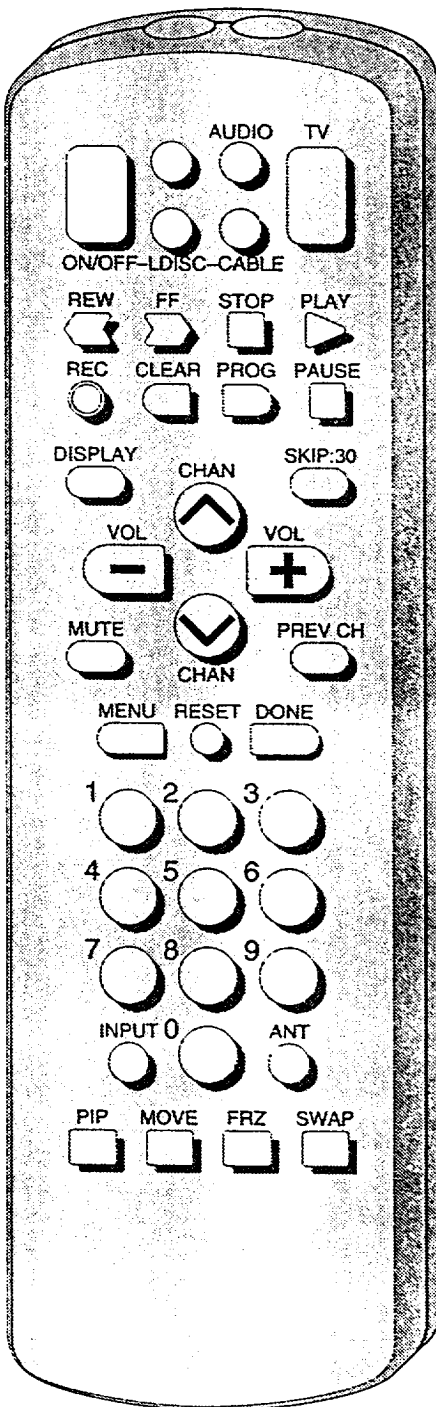

- A. Press channel 00 on the TV to see what the VCR is doing.
- B. Press VCR1 or VCR2 to set the remote to control the VCR.
- C. Press ON/OFF to turn on the VCR if it did not turn on when you pressed VCR1 or VCR2.

Turn off the VCR

- A. Press VCR1 or VCR2 to set the remote to control the VCR.
- B. Press ON/OFF.

Using Your TV and Remote

With VCRs: Basic Operation

If the remote operates your VCR, this page and page 10 will show you how to use it for basic functions. See page 7 for more details on buttons used with your VCR.

Record one TV program and watch another

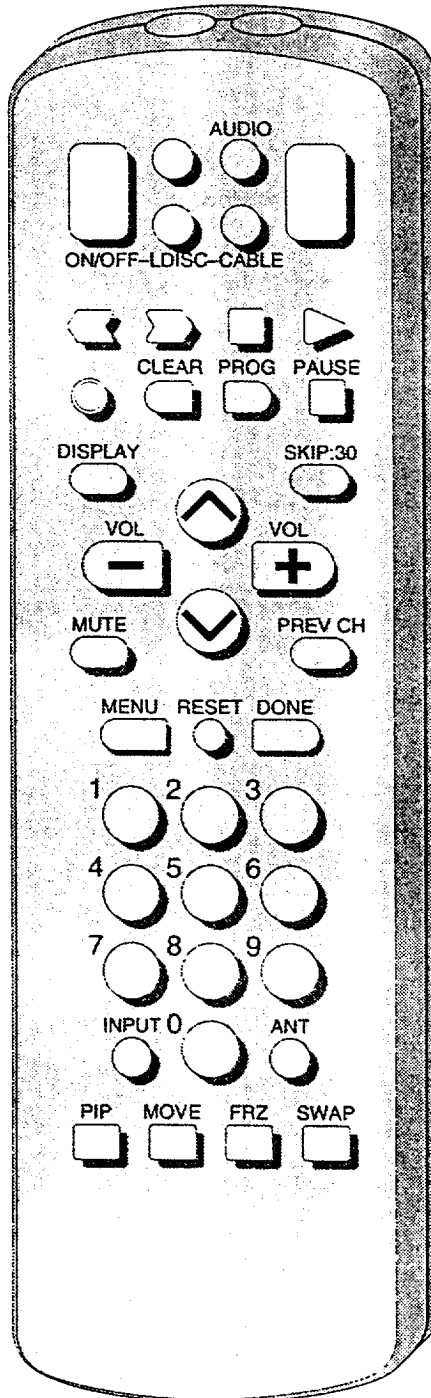

- A. Press VCR1 or VCR2 to set the remote to control the VCR.
- B. Tune the VCR to the channel you want to record using CHANNEL up and down or pressing two number buttons.
- C. Press RECORD to start recording.
- D. Press TV/VCR on the VCR.
- E. Press TV to set the remote to control the TV.
- F. Press CHANNEL up or down to change channels on the TV.
- G. To see the channel you are recording, tune the TV back to channel 00.

Watch a tape in your VCR

- A. Turn on VCR.
- B. Insert a tape in the VCR.
- C. Press PLAY to start the tape playing.
- D. Press STOP when you are finished.
- E. Press REW to rewind the tape.

Using Your TV and Remote

With a Cable Box: Programming and Basic Operation

Refer to the Connection Book or contact your cable company to hook up your cable box. If you have a cable box with its own remote, then you may also be able to use the TV's remote with your cable box. Use the codes below or on the sheet packed in with your remote.

Program the remote for your cable box

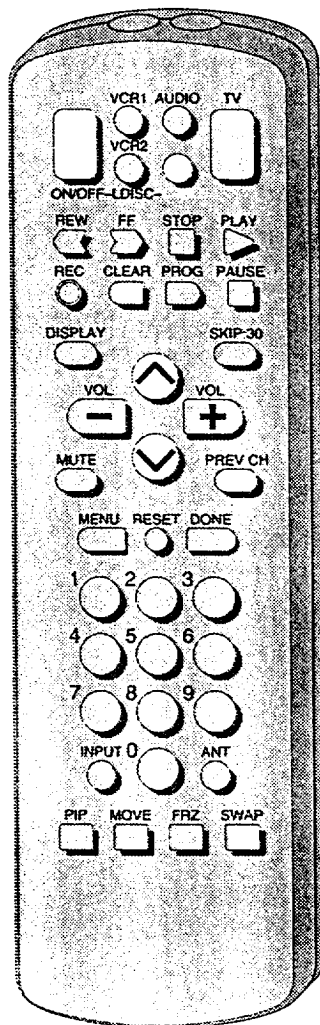

- A. Point the remote at the cable box and hold CABLE.
- B. Enter the code numbers for your brand from the list below.
- C. Release CABLE.
- D. Press ON/OFF to turn it on. If nothing happens, try pressing CABLE and then ON/OFF.
- E. Repeat A-D with another code if the first one does not work.

Basic Operation:

Turn on the Cable Box

- A. Tune TV to channel 02, 03, 04, 05, or 06.
- B. Point remote at the cable box and press CABLE.
- C. Press ON/OFF to turn it on.
- D. Press CHANNEL up or down to change channels on the cable box.

Turn off the Cable Box

- A. Press CABLE.
- B. Press ON/OFF to turn it off.

Cable Box Codes

ABC	22,46	NSC	09	Sprucer	27
Anvision	07,08	Oak	01,16,38	Starcom	46
Cablestar	07,08	Oak Sigma	16	Sylvania	11
Eagle	08	Panasonic	03,27,39	Teknika	06
Eastern International	02	Philips		Texscan	10,11
General Instrument07,08,19,21,26,28,29,32,33,40,41		Tocom	17,21,49,50
.....04,05,15,23,24,25,30,36,46		Pioneer	18,20,44	Unika	31,32,41
Hamlin	12,13,34,48	Randtek	07,08	Viewstar	
Hitachi	37,43,46	RCA	00,2707,08,19,21,26,28,29,32,33,40,41	
Jerrold		Regal	12,13	Warner Amex	44
.....04,05,15,23,24,25,30,36,45,46,47		Regency	02,33	Zenith	14,42
MACOM	37,43	Samsung	44		
Magnavox		Scientific Atlanta	03,22,35		
.....07,08,19,21,26,28,29,32,33,40,41		Signature	46		

Using Your TV and Remote

With a Cable Box: Setting the Cable Channel

The Cable Channel works with CABLE on the remote. If the Cable Channel is set, pressing CABLE selects the channel to see cable channels. The Cable Channel setting depends on which channel your cable box must be on to see cable channels. The channels usually used are 02, 03, 04, 05 or 06. Consult your cable company for more information.

1. Select the Setup menu

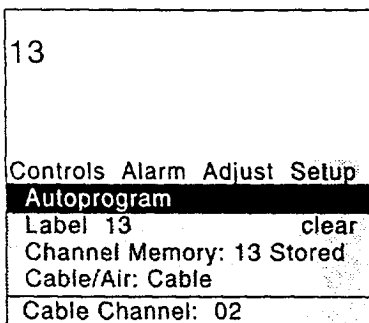

- A. Press TV to set the remote to control the TV.
- B. Press MENU to select the Setup menu. This menu is white.

2. Highlight Cable Channel

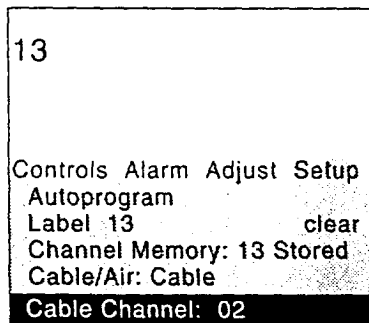

- A. Press CHANNEL down to move down the menu until Cable Channel is highlighted.
- B. Press + to underline the channel.

3. Enter channel number

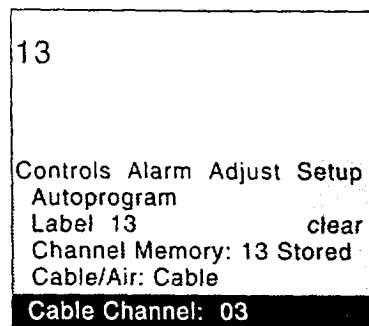

- A. Enter the number for your cable box, either 02, 03, 04, 05, or 06.
- B. Press DONE to save the setting.

4. Press DONE to save the setting

Using Your TV and Remote

With a Laserdisc: Programming and Basic Operation

Refer to your Laserdisc owner's manual to hook up your Laserdisc Player. The remote may need to be programmed for your laserdisc. Use the codes below or on the sheet packed in with your remote.

Program the remote for your laserdisc

Basic Operation

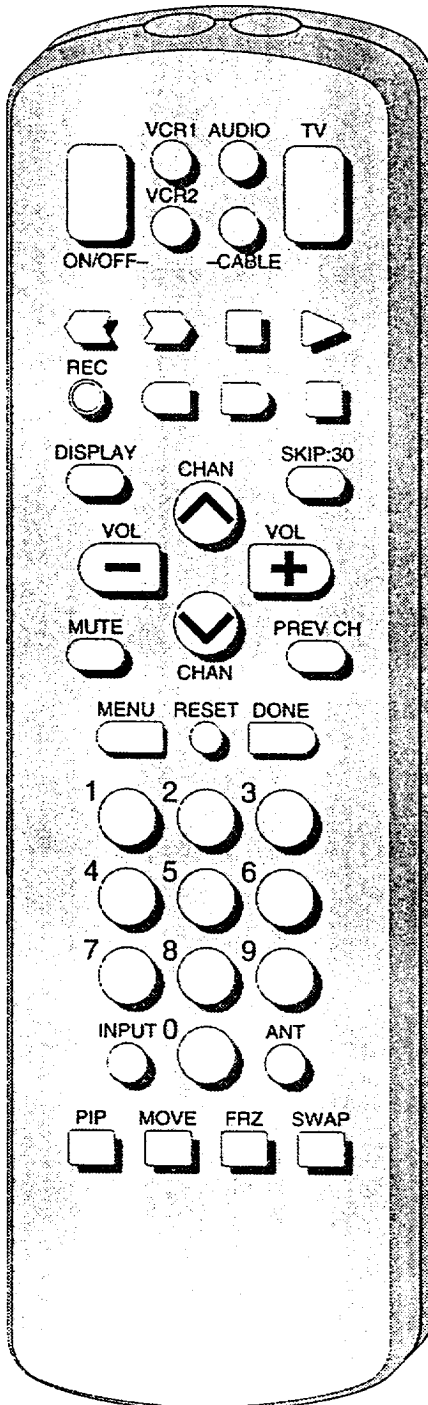

- A. Point the remote at the audio equipment and hold LDISC.
 - B. Enter the code for your brand from the code list below.
 - C. Release LDISC.
 - D. Press ON/OFF. If nothing happens, try pressing LDISC and then ON/OFF.
-
- A. Tune TV to channel 00, 03, or 04.
 - B. Point the remote at the Laserdisc and press LDISC.
 - C. Press ON/OFF to turn it on.
 - D. Use the buttons on the remote that relate to laserdisc functions. Not all buttons highlighted may work with your laserdisc.
 - F. Press ON/OFF to turn it off.

Laserdisc Codes

Pioneer	33
Proscan	33
RCA	33

Using Your TV and Remote

With Audio Equipment: Programming and Basic Operation

Refer to the Connection Book or your Audio equipment owner's manual to hook up your audio equipment. Your remote controls some audio equipment such as a radio, CD player, tape player, turntable, or amplifier. The remote may need to be programmed for your equipment. Use the codes below or on the sheet packed in with your remote.

Program the remote for audio equipment

Basic Operation

Audio Codes

RCA/ Dimensia	
AM/FM.....	.03
CD.....	.07
Tape.....	.06
Phono.....	.05
Aux.....	.04

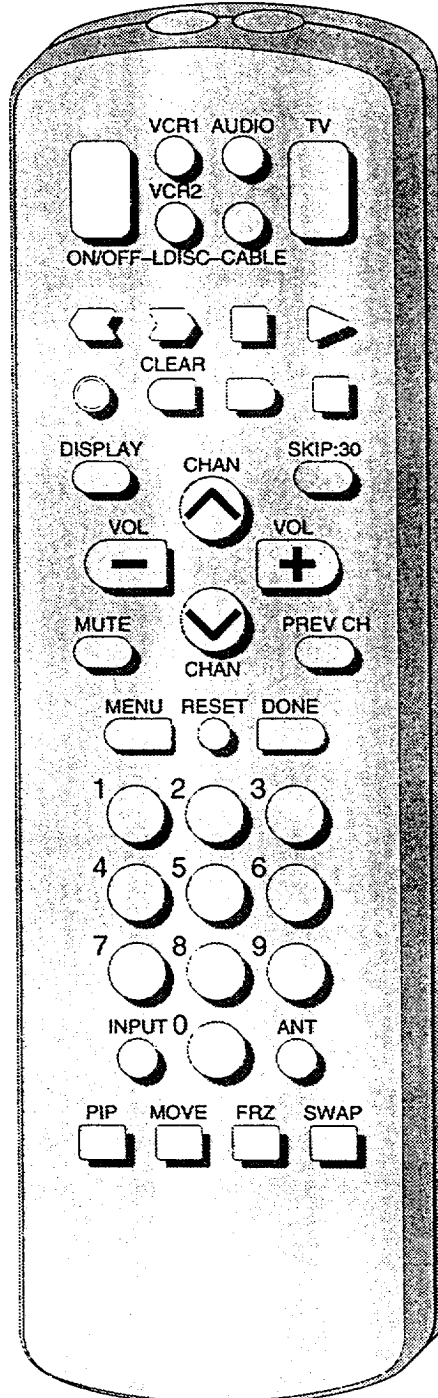

- A. Point the remote at the audio equipment and hold AUDIO.
- B. Enter the code from the code list.
- C. Release AUDIO.
- D. Press ON/OFF to turn it on. If nothing happens, try pressing AUDIO and then ON/OFF.
- E. Repeat A-D with another code if the first one does not work.

- A. Point the remote at the audio equipment and press AUDIO.
- B. Press ON/OFF to turn it on.
- C. Use the buttons on the remote that relate to audio functions. Not all buttons highlighted may work with your equipment.
- D. Turn the audio equipment off using the audio component's power off button.

Adjusting Your TV

Overall Picture

Follow the steps below to lighten or darken the overall picture without changing the color level.

1. Select the Controls Menu

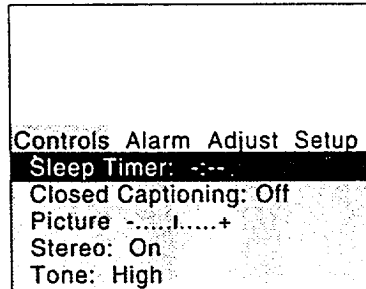

Press **MENU** to select the Controls menu. This menu is yellow.

2. Highlight Picture

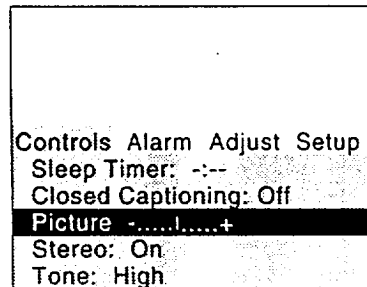

Press **CHANNEL** down to highlight Picture.

3. Use **VOLUME +** and **-** to adjust the Picture

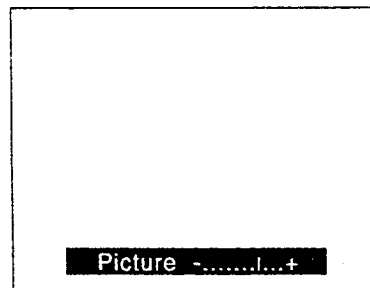

A. Press **+** to lighten the picture.

OR

Press **-** to darken the picture.

B. Press **DONE** to save the setting.

4. Press **DONE** to save the setting

Adjusting Your TV

Picture Settings

Follow the steps below to change the picture on the screen to your personal setting. The chart at the bottom of the page explains your options.

1. Select the Adjust Menu

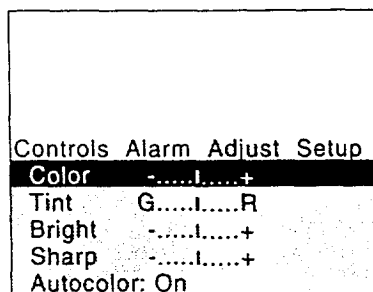

Press MENU repeatedly to select the Adjust menu. This menu is light blue.

2. Highlight item to change

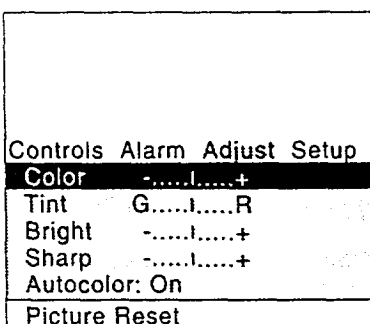

Press CHANNEL down to highlight the picture item you want to adjust.

3. Use VOLUME + or - to adjust each item

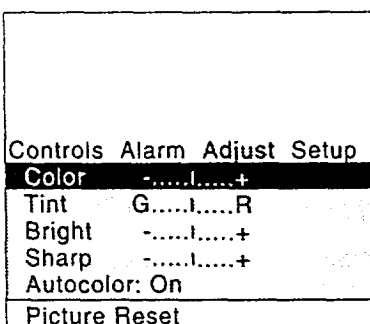

Press + or - to adjust each item.

4. Press DONE to save the setting

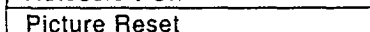

Press DONE to save the setting.

	Press VOLUME + to:	Press VOLUME - to:
Color	Increase color richness	Lower color to black and white
Tint	Give red tint to skin color	Give green tint to skin color
Bright (Brightness)	Add more light to dark parts of the picture	Add more dark to light parts of the picture
Sharp (Sharpness)	Show cleaner, clearer images	Make picture more smooth
Autocolor	Turn on to keep Color and Tint in proper balance each time you change channels	Turn off for manual adjustment of Color and Tint
Picture Reset	Reset the picture back to the original settings	Reset the picture back to the original settings

Adjusting Your TV

Sound Settings: Stereo and Tone

Follow these steps to adjust the Stereo or Tone of your TV. The chart below explains your options.

1. Select the Controls Menu

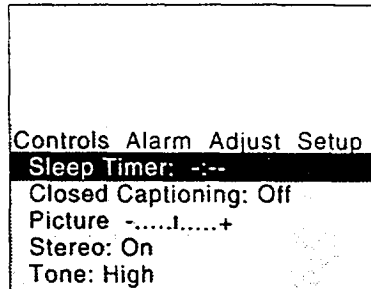

Press MENU to select the Controls menu. This menu is yellow.

2. Highlight item to change

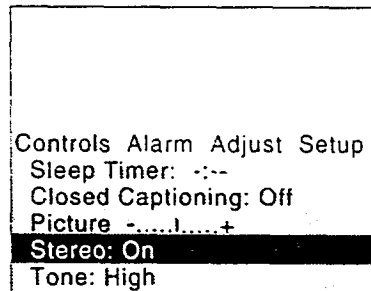

Press CHANNEL down to highlight the sound item you want to adjust.

3. Use VOLUME + or - to adjust each item

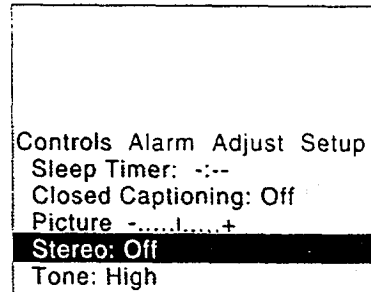

Press + or - to adjust each item.

4. Press DONE to save the setting

Press DONE to save the setting.

Stereo	On Sound is automatically reproduced in stereo or mono, whichever the TV station is broadcasting.	Off Sound is reproduced in mono.
Tone	High High pitched sounds are louder.	Low Low pitched sounds are louder.

Adjusting Your TV

Sound Settings: Speakers

Follow the steps below to turn the speakers on or off in your TV. The chart below explains your options. This set incorporates special circuits which enhance stereo imaging and effect when used with the TV's own speakers. If external speakers are used the enhanced stereo effect may decrease.

1. Select the Setup Menu

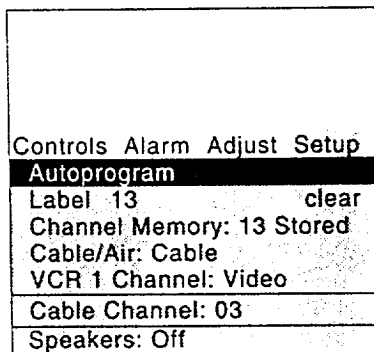

Press MENU repeatedly to select the Setup menu. This menu is white.

2. Highlight speakers

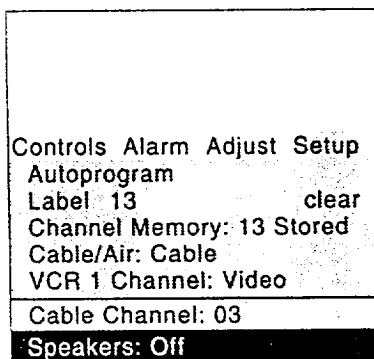

Press CHANNEL down until Speakers is highlighted.

3. Turn Speakers on or off

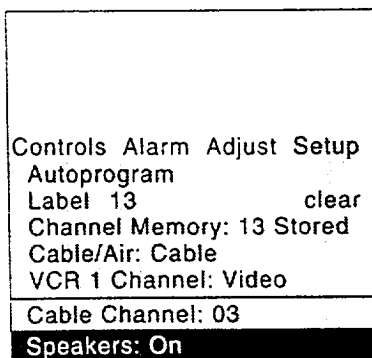

Press + or - to turn the speakers on or off.

4. Press DONE to save the setting

Press DONE to save the setting.

Speakers	On	Off
	The sound comes from the TV's internal speakers.	No sound comes from the TV. The sound is directed through the speakers of an amplifier that is connected to your TV.

Using Advanced Features

Placing Channels in Memory (Autoprogramming)

Only channels 2-13 appear in the TV's memory when you first turn it on. The channels available in your area must be programmed into the TV's memory when you hook up your TV. Using CHANNEL up or down allows you to scan through these channels.

You may want to add or delete a few channels if some stations have weak signals or were off the air when the TV was programmed. Refer to the Add or Delete Channels section below.

1. Place channels in memory (autoprogram)

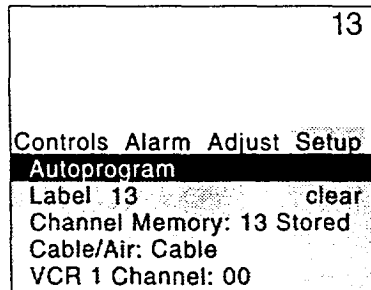

- A. Hook up an antenna, cable or components before you begin these steps or you will not be able to add channels into memory.
- B. Press MENU repeatedly to select the Setup Menu and highlight Autoprogram. This menu is white.
- C. Press + to start the TV adding all the channels into memory.
- D. Wait until the TV has cycled through all the channels and returns to the original channel.

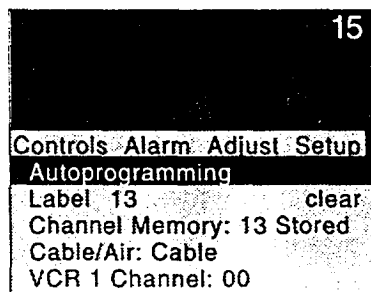

2. Add or delete channels

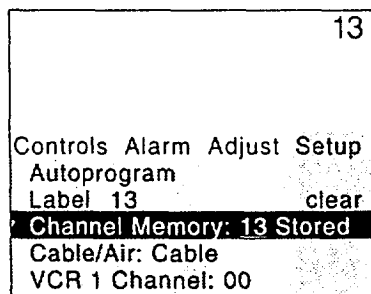

- A. Press MENU repeatedly to select the Setup menu. This menu is white.
- B. Press CHANNEL down to highlight Channel Memory.
- C. Select the channel number you want to add or delete with the number buttons.
- D. Press + to add or delete a channel (you will see Stored on the screen to add and Erased to delete).
- E. Repeat C and D for more channels.
- F. Press DONE to save the setting.

3. Press DONE to save the setting

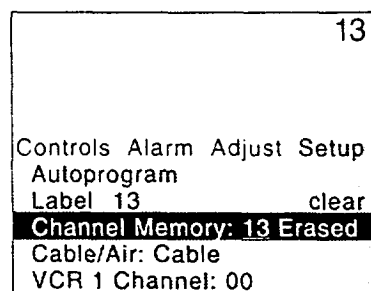

Using Advanced Features

Naming the Channels

You can name at least 20 channels with four characters in each name. Full appears beside Label when the memory is used up. Fixed appears when a channel number cannot be named. Below are the characters that can be used in a name.

1. Name a channel

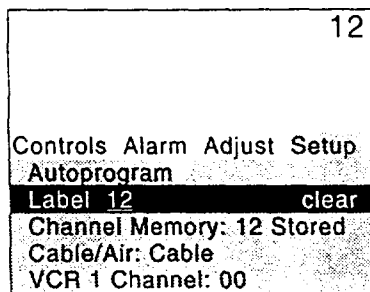

- A. Press MENU repeatedly to select the Setup menu. This menu is white.
- B. Press CHANNEL down to highlight Label.
- C. Press + to underline the channel number.
- D. Select the channel number with the number buttons.
- E. Press + to underline the first character of the name.
- F. Choose the character using CHANNEL up or down.
- G. Repeat E-F to complete the name.
- H. Press - to move backward if you want to change an item.
- I. Press DONE to save the setting.

2. Press DONE to save the setting

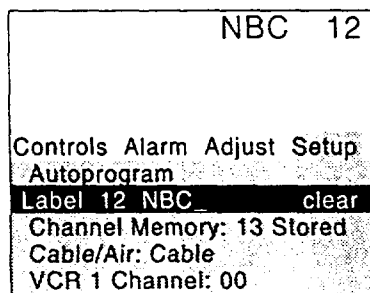

3. Erase a name

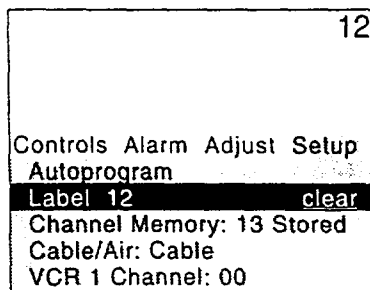

- A. Follow A and B above.
- B. Press + until clear is underlined.
- C. Press CHANNEL up or down to clear the name.
- D. Press DONE to clear the name.

4. Press DONE to clear the name

Character List

A B C D E F G H I J K L M N O P Q R S T U V W X Y Z &
' () á + , - . / 0 1 2 3 4 5 6 7 8 9 : ; < = > ? @ blank space

Using Advanced Features

Setting the Sleep Timer

You can set your TV to turn itself off. If you're watching TV at night and fall asleep, the TV will turn off for you.

1. Set Sleep Timer

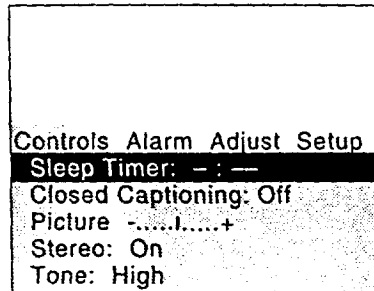

A. Press MENU to select the Controls menu and highlight Sleep Timer. This menu is yellow.

B. Press + enter the amount of time you want to watch TV before it shuts off. Each press equals 15 minutes.

C. Press - to subtract time from the sleep timer.

D. Press DONE to save the setting.

2. Press Done to save the setting

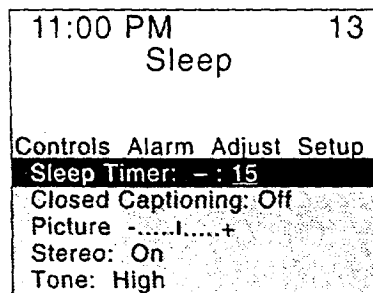

3. Add more time

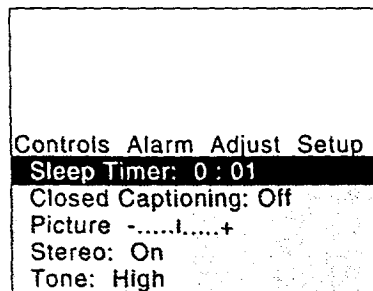

A. When 0:01 appears on the screen, the TV will shut off in one minute. Press + to add more time.

4. Cancel the Timer

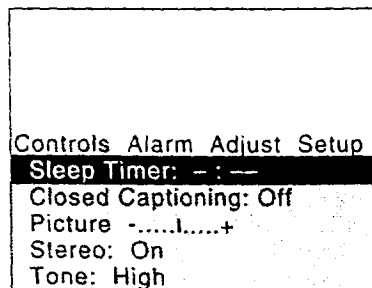

A. Press MENU to select the Controls menu and highlight Sleep Timer.

B. Press - until the time reaches - : - -.

C. Press DONE to save the setting.

Using Advanced Features

Setting the Alarm Clock

The TV can be set to turn on each day like your alarm clock. You can set it to turn on to your favorite channel at a certain time. You can also set it to turn itself off again. The Alarm cannot be used until the clock is set.

1. Turn on the Alarm

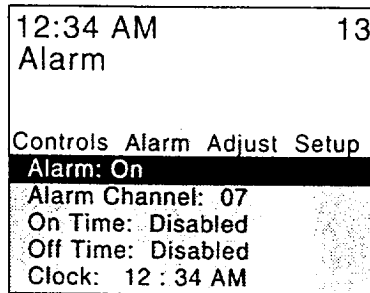

- A. Press MENU to select the Alarm menu and highlight Alarm. This menu is green.
- B. Press + or - to select On or Off.

2. Set the Alarm Channel

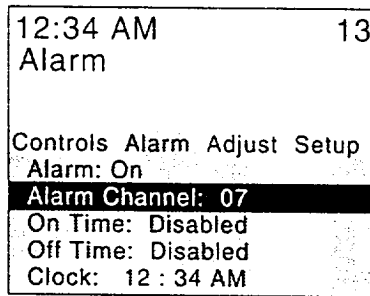

- A. Press CHANNEL down to highlight the Alarm Channel.
- B. Press + to highlight the channel number.
- C. Enter the channel that you want the TV to turn on to with the number buttons.
- D. Press DONE to save the setting.

3. Press Done to save the setting

4. Set On and Off Times

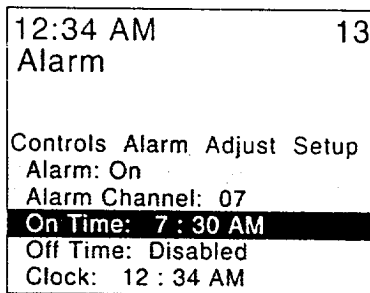

- A. Press CHANNEL down to highlight the On or Off Time.
- B. Press - to set the hour.
- C. Press + to set the minutes.
- D. Press and hold - to choose Disabled. This turns the TV only on or only off at a certain time each day.
- E. Press DONE to save the setting.

5. Press Done to save the setting

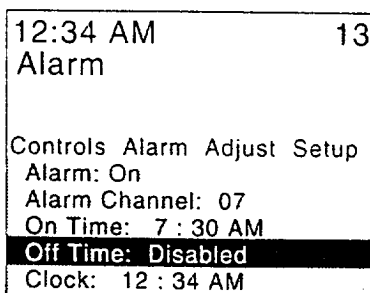

Using Advanced Features

Watching Picture-in-Picture

Picture-in-Picture allows you to display a small picture within the big picture of the TV screen. To watch two different programs at once, you must connect a VCR, LaserDisc or Camcorder. You may need to disable the VCR1 Channel if you can not get two different programs at once.

Turn on Picture-in-Picture

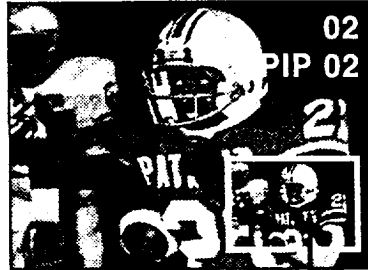

TV Picture

TV Picture

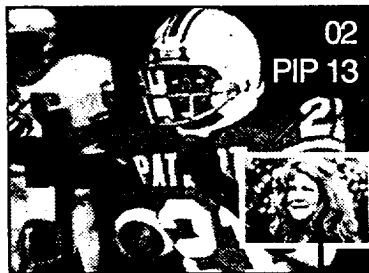

TV Picture

VCR, Laserdisc,
or Camcorder
Picture

- A. Hook up a VCR, Laserdisc player, or Camcorder to the video jacks on the back of the TV. *See the Connections Guide.*
- B. Press TV to turn the TV on.
- C. Press CHANNEL up or down to select the channel you want to watch on the big picture.
- D. Turn on the VCR, Laserdisc player, or Camcorder.
- E. Press PIP to put the small picture on the screen. It is the same as the big picture.
- F. Press 00 to see the signal from the VCR, Laserdisc player, or Camcorder connected to the video jacks in A.

Change channels on the large picture



- A. Press CHANNEL up and down or two number buttons to change channels on the large picture.

Change channels on the small picture



- A. Change channels on your VCR, Laserdisc player, or Camcorder to change channels on the small picture.

Using Advanced Features

Watching Picture-in-Picture

Move the small picture

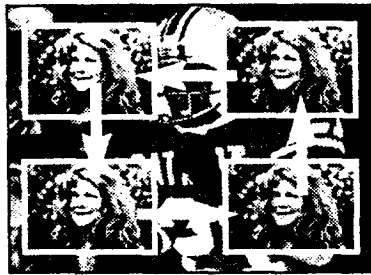

Press MOVE to move the small picture to the next corner.

Swap the big picture with the little picture



Press SWAP to switch the small picture with the big picture.

Freeze the small picture



- A. Press FREEZE to stop action in the small picture.
- B. Press FREEZE again to return to an action picture.

Turn off Picture-in-Picture

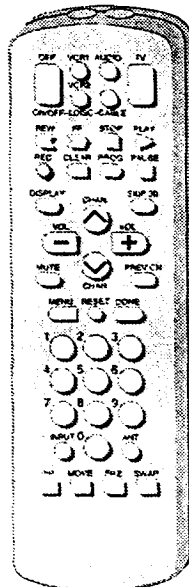

- A. Press PIP to turn off picture-in-picture.

Using Advanced Features

Setting Your TV for Antenna or Cable

Your TV automatically adjusts this feature when the TV places channels in memory (autoprogram). Follow the steps below to change the setting as needed.

1. Select the Setup menu

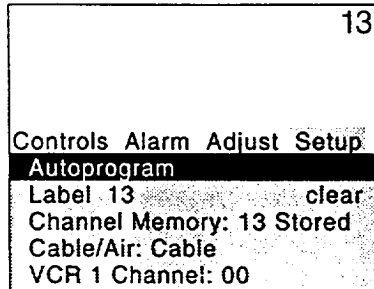

Press MENU repeatedly to select the Setup menu. This menu is white.

2. Highlight Cable/Air

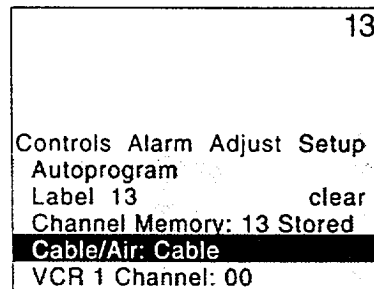

Press CHANNEL down to highlight Cable/Air.

3. Select Cable or Air

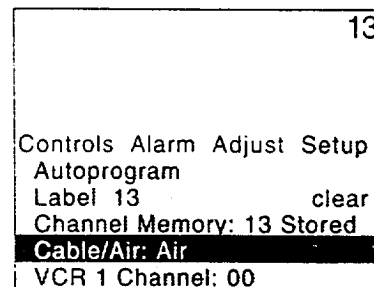

A. Press + or - to select Cable or Air. Select Cable if you have cable. Select Air if you have a home antenna connected to your TV.

4. Press DONE to save the setting

B. Press DONE to save the setting.

References

Front Panel Buttons

For details on using buttons with menus, see Quick Guide to the Menus on page 5.

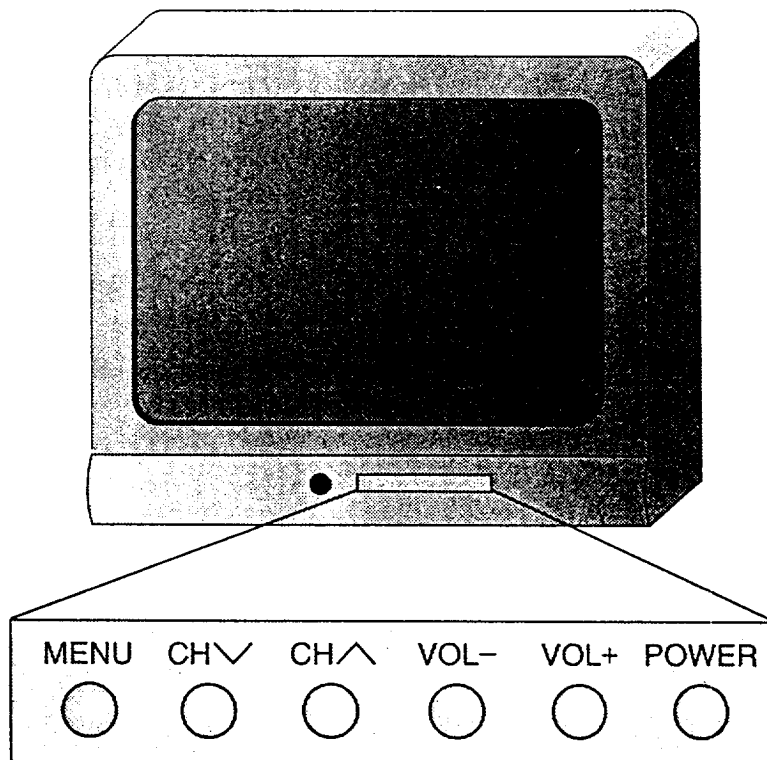

MENU	Shows menus on screen. Moves from menu to menu.
CH ▲ and ▼	Channel up and down. Scans up and down through channels in the TV's memory. Moves up and down menus.
VOL + and -	Volume up and down Raises and lowers sound. Moves left and right on a menu line. Changes a features setting.
POWER	Turns the TV on or off.

References

Displays on the Screen

Your TV shows the settings of several features on the screen. To see what features have been set on your TV, press DISPLAY on the remote.

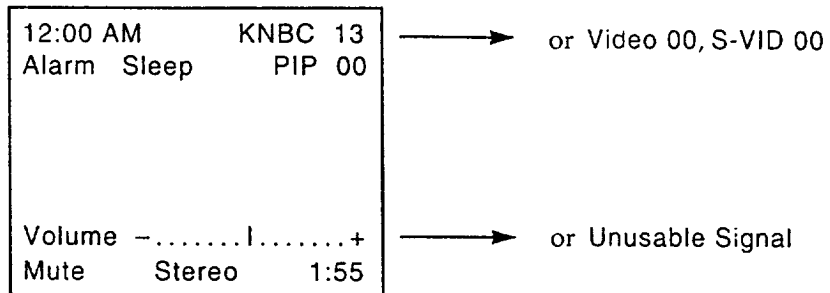

Screen Display

12:00 AM

Description

Time of the clock. *Details are on page 3.*

KNBC

Name you chose to describe the channel. *Details are on page 21.*

13

Channel number you are watching.

S-VID 00

Indicates that a component is connected to the S-VIDEO jack on the back of the TV, it is turned on, and channel 00 is selected.

Video 00

Indicates that a component is connected to the VIDEO jack on the back of the TV, it is turned on, and channel 00 is selected.

Alarm

Alarm clock is set to turn on or off. *Details are on page 23.*

Sleep

Sleep Timer is set to turn off the TV. *Details are on page 22.*

PIP 00

Picture-in-picture is turned on to channel 00. *Details are on pages 24-25.*

Volume

Sound level of the TV.

Unusable Signal

Weak signal is coming in on selected channel.

Mute

There is no sound. *See MUTE button on page 6.*

Stereo

The sound is being broadcast in stereo. *Details are on page 18.*

1:55

The time remaining for commercial skip. *Details are on page 6.*

References

Trouble Checks

You may have problems that can be fixed with a few minor adjustments. Look for the type of problem you are having below and try the suggestions to get your TV going again. *For warranty information see the back cover.*

Trouble	Checks and Adjustments
<u>Power</u>	
TV will not turn on	Plug TV in. Plug something else into the outlet to make sure it is working. Make sure batteries in the remote are not dead. Aim the remote at the TV and press TV. Make sure batteries are placed in the remote the right way. <i>See batteries on page 2.</i> Unplug TV for a few minutes and then turn it on again.
No picture, no sound but TV has power	Check antenna connections. Check position of Cable/Air feature. <i>See page 27.</i> Try another channel. Inactive channel may be tuned. Make sure component connected to the VIDEO INPUT jacks is turned on if you choose channel 00. Make sure TV is tuned to the same channel as the switch on back of VCR if watching a VCR. Make sure TV/VCR button on VCR is in correct position.
<u>Picture</u>	
Blank screen or Unusable Signal appears on screen	Try another channel. Scan the channels.
Picture poor, sound okay	Check antenna connections. Adjust TV picture. <i>See pages 16–17.</i>
<u>Picture-in-Picture</u>	
Can't get two different channels in picture-in-picture	Make sure small picture is tuned to channel 00. Make sure the component connected to the back of the TV is turned on. Make sure a video cable is also connected to the TV's VIDEO INPUT jack if using an S-VHS component. Make sure the AUDIO and VIDEO OUT jacks on the VCR, Laserdisc player, or Camcorder are connected to the TV's VIDEO and AUDIO IN jacks. Make sure VCR 1 Channel is set to Disabled. <i>See page 9.</i>
No picture while using picture-in-picture with S-VHS VCR or camcorder	Make sure a video cable is also connected to the TV's VIDEO INPUT jack.

Reference

Trouble Checks

Trouble

Checks and Adjustments

Remote

Buttons don't work when you press them

Press TV to set the remote to control the TV. *See buttons on page 6-7.*

Works part or none of the time

Clear the path between the remote and TV of any objects.
Aim the remote at the component you are trying to control.
Press TV so remote will control TV.
Make sure batteries in the remote are not dead.
See if batteries are placed in remote correctly. *See batteries, page 2.*

Can't select certain channel

Press number buttons. Channel may not be in memory. *See autoprogram on page 20.*
Make sure TV/VCR switch on VCR is in the TV position.
For numbers over 100, press and hold 1 until 1-- appears, then press the other two numbers.
Set Cable/Air feature to Cable for channels higher than 69. *See page 27.*

Sound

Noisy stereo reception

Turn Stereo off. The stereo broadcast may not be clear. *See page 18.*

Picture okay, no sound

Press VOLUME + or MUTE to restore sound.
Make sure TV's speakers are on. *Details are on page 19.*

Picture okay, sound poor

Try another channel.
Try adjusting the Tone. *See page 18.*
Change Stereo to off. The stereo broadcast may not be clear. *See page 18.*

No stereo on stereo station

Make sure Stereo is turned on. *See page 18.*

TV Turns on or off

Turns off by itself

Check Sleep Timer. *See sleep timer on page 22.*
Wait 30 seconds and turn on again, a power surge may have occurred.
Check Alarm Off time. *See alarm clock on page 23.*

Turns on by itself

Check Alarm On Time. *See alarm clock on page 23.*
Check clock time. *See clock on page 3.*

Does not turn off at Alarm Time

Make sure alarm is turned on or off. *See alarm clock on page 23.*
Check clock time. *See clock on page 3.*

References

Glossary

Antenna

A device used to receive locally broadcast signals from TV stations.

Audio

Sound coming from the TV.

Audio/video cables

Cables that carry sound and picture from one component to another.

Autocolor

Adjusts the Color and Tint of the picture to the proper balance for each channel.

Autoprogram

A procedure that automatically adds only the active channels in your area to the TV's memory.

Brightness

Light and dark areas of a picture.

Channel Label

A name that is given to a specific channel number.

Channel Memory

Where channels are stored after they have been placed in memory. Channels can be added or deleted from channel memory.

Commerical Skip

A feature that allows the viewer to scan other channels during commercials, and return to the original channel after the break.

Component

Device such as VCR, laserdisc, audio equipment, camcorder, etc.

Disabled

Turns off feature.

Display

A word, words or graphics that appear on the TV screen.

Inputs

Located on back of the TV for connection of a component to the TV. Used to route signals into the TV from components.

Jacks

Connectors located on the back of the TV for connecting antennas or other components.

Menu

A listing of features, controls, and adjustments shown on the TV screen that can be changed.

Mono

Slang for monaural. Sound comes through one channel. Monaural components will have only one audio jack.

On-Screen Display

See Display.

Outputs

Located on back of the TV for connection of another component. Signals are routed out of the TV into the other component.

Picture-in-picture

A feature that allows you to watch two channels at the same time, a small picture within a big picture. The smaller picture comes from a VCR or other component connected to the TV.

Picture Reset

Returns all of your TV picture adjustments back to the factory setting.

PIP

Short for picture-in-picture.

S-VHS

Super Video. A format used by VCRs and Camcorders which improves the picture quality. S-VIDEO appears on the TV screen when you use this feature.

S-VIDEO *See S-VHS.*

Sharpness

Clearness of a picture.

Skip:30 *See Commerical Skip.*

Signal

Electrical waves that are sent or received through cables.

Sleep Timer

A feature where the TV can be set to turn off at a specific time within four hours.

Source(s)

Components or devices that are connected to the TV.

Stereo

Sound that comes through two channels (left and right). Stereo components have two audio output jacks.

Tone

Quality of the sound.

Tuner

A device that receives and sends signals. The signals can be adjusted with the tuner.

Unusable Signal

A message that shows no signal is coming in on the channel selected.

Video

Picture reproduced by the television.

References

Index

- A**
- Adding Channels to Memory3,20
 - Adjust Menu
 - Adjusting
 - Picture16
 - Picture Quality17
 - Sound Quality18,19
 - Air or Cable Feature27
 - Alarm Channel23
 - Alarm Clock23
 - Alarm Display28
 - Alarm Menu23
 - ANT Button7
 - Antenna27
 - AUDIO Button7,15
 - Audio Codes15
 - Audio Equipment Buttons15
 - Autocolor17,35
 - Autoprogram3,20,35
- B**
- Batteries (Remote)2
 - Brightness17,35
 - Buttons
 - and -2,3,4,5,6,7
 - Audio Equipment15
 - Component4
 - Laserdisc14
 - Menu4,5
 - Number6
 - Picture-in-Picture4,7,24,25,35
 - Power6
 - Remote Control4,6,7
 - Signal7
 - TV4,12
 - TV Front Panel11
 - VCR13
- C**
- CABLE/ANTENNA Jack15
 - Cable Box12,13
 - CABLE Button7,12,13
 - Cable Channel13
 - Cable or Air Feature27
 - Cancelling Sleep Timer22
 - Captioning, Closed26
 - Cautionsi
 - Channel Label21,35
 - Channel Memory3,20,35
 - CHANNEL Up / Down Buttons
 - Remote4,5,6
 - TV28
 - Channels
 - Adding3,20
 - Deleting20
 - Naming21,29
 - Placing in Memory3,20
 - Checks and Adjustments30,31
 - CleaningBack Cover
 - CLEAR Button6,7
 - Clock3,23
- D**
- Closed Captioning26
 - Colors (Menus)5
 - Commerical Skip6,29,35
 - Component Buttons13
 - Contents1
- E**
- Delete Channels from Memory20
 - DISPLAY Button23
 - Displays (On-Screen)29
 - DONE Button5,6
- F**
- FF / Fast Forward Button7
 - Front Panel Controls4
 - FRZ / Freeze Button7,25
- G**
- Hook up TVConnections Guide
- H**
- Hook up TVConnections Guide
- I**
- INPUT Button7
- J**
- Laserdisc Player Codes14
 - Laserdisc Player Buttons7,14
- K**
- MENU Buttons4,5
 - Menus5
 - Mono18,35
 - MOVE Button7,25
 - MUTE Button6
- L**
- Laserdisc Player Codes14
 - Laserdisc Player Buttons7,14
- M**
- MENU Buttons4,5
 - Menus5
 - Mono18,35
 - MOVE Button7,25
 - MUTE Button6
- N**
- Naming the Channels21
 - Number Buttons6
- O**
- ON / OFF Button6
 - On-Screen Displays29,35
- P**
- PAUSE Button7,8,14
 - Picture Adjustments16,17
 - Picture-in-Picture4,7,24,25
 - Picture Reset17
 - PIP4,7,24,25
 - Place Channels in Memory3,20
 - PLAY Button7,8,14,15
 - POWER Button2,6
 - PREV CHAN Button6
 - Product Registrationi
 - PROG / Program Button7
 - Programming the Remote
 - Audio Equipment15
 - Cable Box12,13
 - Laserdisc Player14
- Q**
- Quick Guide to Your TV2,3,4,5
 - Quick Button Guide4,5
- R**
- REC / Record Button7,11,15
 - Registration Cardi
 - Remote Control
 - Batteries2
 - Buttons6,7
 - Order Form33
 - Tour4
 - With Components7,8-15
 - RESET Button6
 - REW / Rewind Button7,8,11,14,15
- S**
- Safety Informationi
 - Screen Displays29
 - Set Time3
 - Setting Cable / Air27
 - Setting the Cable Channel12
 - Setting the Sleep Timer22
 - Sharpness17
 - SKIP:306,35
 - Sleep Timer22
 - Sound18,19
 - Speakers19
 - Stereo18,35
 - STOP Button7,8,11,15
 - SWAP Button4,7,24,25
- T**
- Table of Contents1
 - Tint17
 - Tone18,35
 - Trouble Checks30,31
 - TV Button3,4,6
 - Time3
- U**
- Unusable Signal Display29,35
- V**
- VCR
 - Turn on10
 - Turn off10
 - Record one TV program and watch another11
 - Watch a tape11
 - VCR1 and VCR2 Button7,8,9,10
 - VCR 1 Channel8
 - VCR Codes8
 - VOL + and - Buttons4,6,28
- W**
- Warningi
 - Warranty32
 - Watching Closed Captioning26
 - Watching Picture-in-Picture24,25

SEARS

OWNER'S MANUAL

MODEL NO.
274.42798390
SERIES

WHEN ORDERING REPAIR
PARTS, ALWAYS GIVE THE
FOLLOWING INFORMATION:

1. NAME OF ITEM
Sears Color Television
Receiver
2. MODEL NUMBER
3. PART DESCRIPTION

SEARS 27" TABLETOP COLOR TELEVISION WITH REMOTE CONTROL

Your Sears Television has added value when you consider that Sears has service units nationwide staffed with Sears trained technicians—professional technicians specifically trained on Sears home entertainment products, having the parts, tools and equipment to ensure that we meet our pledge to you —“We Service What We Sell.”

For repair service, call:
1-800-4-REPAIR
(1-800-473-7247)

For replacement parts information and ordering, call:
1-800-FON-PART
(1-800-366-7278)

WARRANTY

FULL 90-DAY WARRANTY ON COLOR TELEVISION

For the first 90 days from the date of purchase, Sears will repair this television, free of charge, if defective in material or workmanship.

LIMITED WARRANTY ON ALL PARTS EXCEPT PICTURE TUBE

After 90 days from the date of purchase and up to one year, Sears will furnish, free of charge, a replacement for any defective part in this television. You pay for labor.

LIMITED WARRANTY ON PICTURE TUBE

After 90 days from date of purchase and up to two years, Sears will furnish, free of charge, a replacement for the picture tube, if defective. You pay for labor.

WARRANTY SERVICE IS AVAILABLE BY CONTACTING THE NEAREST SEARS SERVICE CENTER/DEPARTMENT IN THE UNITED STATES.

This warranty gives you specific legal rights, and you may also have other rights which vary from state to state.

Sears, Roebuck and Co., Dept. 817WA, Hoffman Estates, IL 60179