

SAMSUNG

TX-P2665W/TX-P2766

TX-P3066W/TX-P3266

TX-P2664W/TX-P2764

TX-P3064W/TX-P3264

COLOR TELEVISION



**Owner's
Instructions**

Important Warranty Information Regarding Television Format Viewing

Standard screen format televisions (4:3, the aspect ratio of the screen width to height) are primarily designed to view standard format full-motion video. The images displayed on them should primarily be in the standard 4:3 ratio format and constantly moving. Displaying stationary graphics and images on screen, such as the dark top and bottom letterbox bars (wide screen pictures), should be limited to no more than 15% of the total television viewing per week.

Wide screen format televisions (16:9, the aspect ratio of the screen width to height) are primarily designed to view wide screen format full-motion video. The images displayed on them should primarily be in the wide screen 16:9 ratio format, or expanded to fill the screen if your model offers this feature, and constantly moving. Displaying stationary graphics and images on screen, such as the dark side-bars on non-expanded standard format television video and programming, should be limited to no more than 15% of the total television viewing per week.

Additionally, viewing other stationary images and text such as stock market reports, video game displays, station logos, web sites or computer graphics and patterns, should be limited as described above for all televisions. Displaying any stationary images that exceed the above guidelines can cause uneven aging of picture tubes (CRTs) that leave subtle, but permanent burned-in ghost images in the television picture. To avoid this, vary the programming and images, and primarily display full screen moving images, not stationary patterns or dark bars. On television models that offer picture sizing features, use these controls to view the different formats as a full screen picture.

Be careful in the selection and duration of television formats used for viewing. Uneven CRT aging as a result of format selection and use, as well as other burned-in images, is not covered by your Samsung limited warranty.

Chapter 1: Your New TV 5

List of Features	5
Accessories	5
Familiarizing Yourself with The TV	6
Front Panel Buttons	6
Side Panel Jacks	7
Rear Panel Jacks	8
Remote Control	9

Chapter 2: Installation 11

Connecting VHF and UHF Antennas	11
Antennas with 300-ohm Flat Twin Leads	11
Antennas with 75-ohm Round Leads	12
Separate VHF and UHF Antennas	12
Connecting Cable TV	12
Cable without a Cable Box	12
Connecting to a Cable Box that Descrambles All Channels . .	13
Connecting to a Cable Box that Descrambles Some Channels	13
Connecting a VCR	15
Connecting an S-VHS VCR	16
Connecting a Second VCR to Record from the TV	17
Connecting a DVD Player	17
Connecting a Digital TV Set-Top Box (480p/1080i)	18
Connecting a Camcorder	20
Installing Batteries in the Remote Control	21

Chapter 3: Operation 22

Turning the TV On and Off	22
Plug & Play Feature	22
Viewing the Menus and On-Screen Displays	24
Viewing the Menus	24
Viewing the Display	24
Selecting a Menu Language	25
Memorizing the Channels	26
Selecting the Video Signal-source	26
Storing Channels in Memory (Automatic Method)	27
Adding and Erasing Channels (Manual Method)	28
Changing Channels	29
Using the Channel Buttons	29
Directly Accessing Channels	29
Using the PRE-CH Button to select the Previous Channel . .	29
Labeling the Channels	30
Setting the Clock	31
Customizing the Picture	34
Using Automatic Picture Settings	35
Adjusting the Volume	36
Using the Mute Button	36

Chapter 3: Operation (Cont.) 37

Customizing the Sound 37
 Using Automatic Sound Settings 38
 Viewing an External Signal Source 39
 Setting the Signal Source 39
 Assigning Names to External input mode 40

Chapter 4: Special Features 41

Fine Tuning Channels 41
 Changing the Color Tone 42
 Changing the Screen Size 43
 Digital Noise Reduction 44
 Tilt 45
 Using the R.Surf Feature 46
 Freezing the Picture 46
 Choosing a Multi-Channel Sound (MTS) Soundtrack 47
 Adjusting the Volume Automatically 48
 Setting the Surround 49
 Setting the Turbo Sound 50
 Setting the On/Off Timer 51
 Setting the Sleep Timer 52
 Setting the Preferred Volume Level and Channel 53
 Viewing Closed Captions 54
 Setting The On/Off Melody 55
 Using the V-Chip 56
 Customizing Your Remote Control 63

Chapter 5: Troubleshooting 65

Identifying Problems 65

Appendix 66

Cleaning and Maintaining Your TV 66
 Using Your TV in Another Country 66
 Specifications 66

Chapter One

YOUR NEW TV

List of Features

Your TV was designed with the latest technology. This TV is a high-performance unit that includes the following special features:

- Full Flat Screen
- Automatic timer to turn the TV on and off
- Adjustable picture and sound settings that can be stored in the TV's memory
- Automatic channel tuning for up to 181 channels
- A special filter to reduce or eliminate reception problems
- A built-in multi-channel sound decoder for stereo and bilingual listening
- Built-in, dual channel speakers
- A special sleep timer
- V-Chip function

Accessories

Once you have unpacked your TV, check to make sure that you have all the parts shown here. If any piece is missing or broken, call your dealer.



Remote Control(AA59-00322B)/
AAA Batteries(4301-000121)



Owner's Instructions/
Safety Guide Manual



Warranty Card; 2EA/
Registration Card

Familiarizing Yourself with The TV

Front Panel Buttons

The buttons on the front panel control your TV's basic features, including the on-screen menu. To use the more advanced features, you must use the remote control.

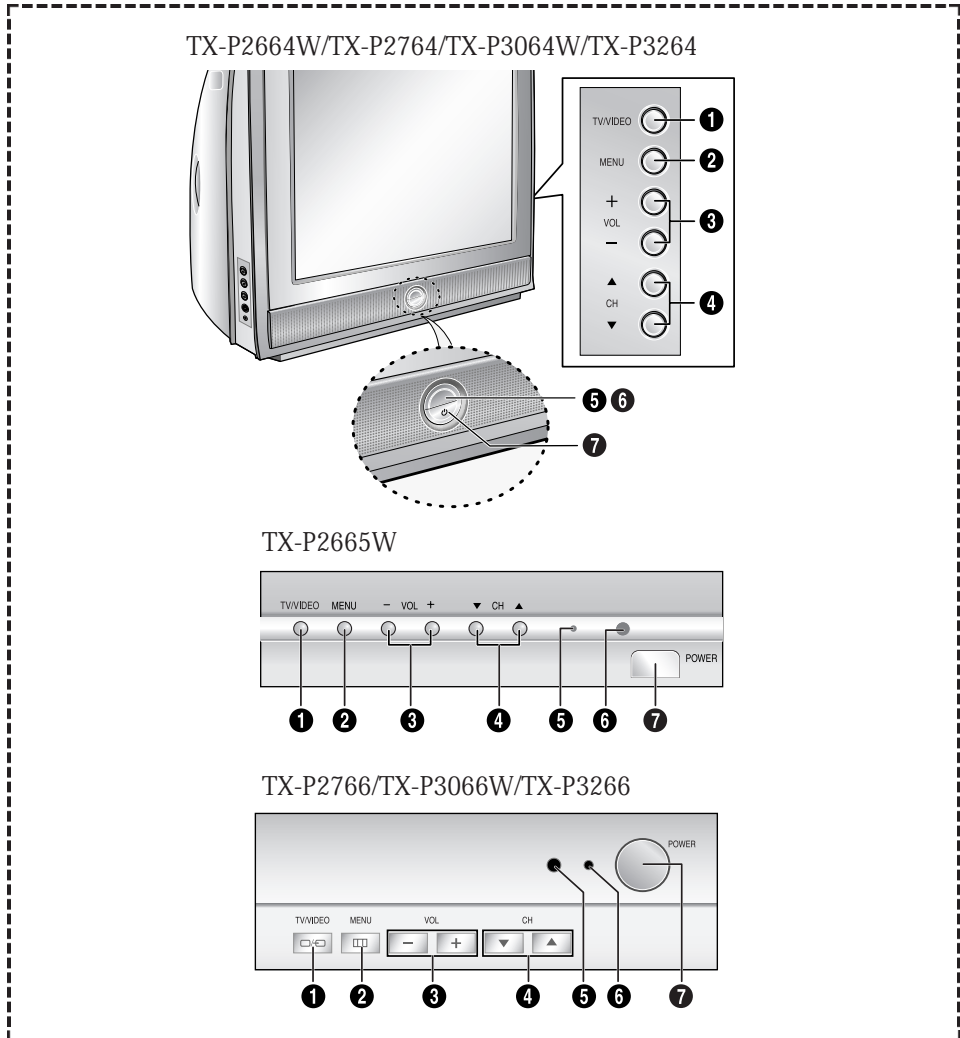

1 TV/VIDEO

Press to change between viewing TV programs and signals from other components.

2 MENU

Press to see an on-screen menu of your TV's features.

3 VOL – and +

Press to increase or decrease the volume. Also used to select items on the on-screen menu.

4 CH ∇ and CH ▲

Press to change channels. Also press to select various items on the on-screen menu.

5 Remote Control Sensor

Aim the remote control towards this spot on the TV.

6 TIMER indicator

When the TV is turned on, the TIMER indicator blinks five times. This indicator illuminates when the TIMER mode is set to the "On" position after setting the clock and either the On timer or Off timer, with the remote control. Even if the power is turned off, this indicator stays lit. (Clock must be set before using this function.)

7 POWER

Press to turn the TV on and off.

Side Panel Jacks

You can use the side panel jacks to connect an A/V component that is used only occasionally, such as a camcorder or video game. (For information on connecting equipment, see page 20.)

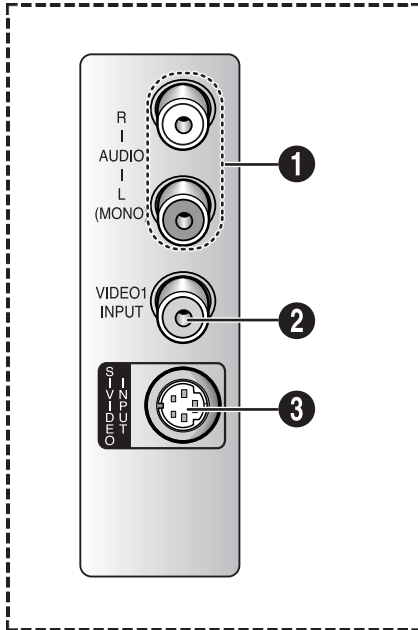

1 AUDIO INPUT jacks

Used to connect the audio signals from a camcorder or video game.

2 VIDEO INPUT jack

Used to connect a video signal from a camcorder or video game.

3 SUPER VIDEO INPUT jack

S-Video signal from an S-VHS VCR or DVD player.

Note: In S-Video mode, Audio Output depends what kind of audio input source is connected to the side audio input jacks (AV1).

Rear Panel Jacks

Use the rear panel jacks to connect an A/V component that will be connected continuously, such as a VCR or a DVD player. Because there are three sets of input jacks, you can connect three different A/V components (i.e., a VCR and a DVD, 2 VCRs, etc.)

For more information on connecting equipment, see pages 11 – 19.

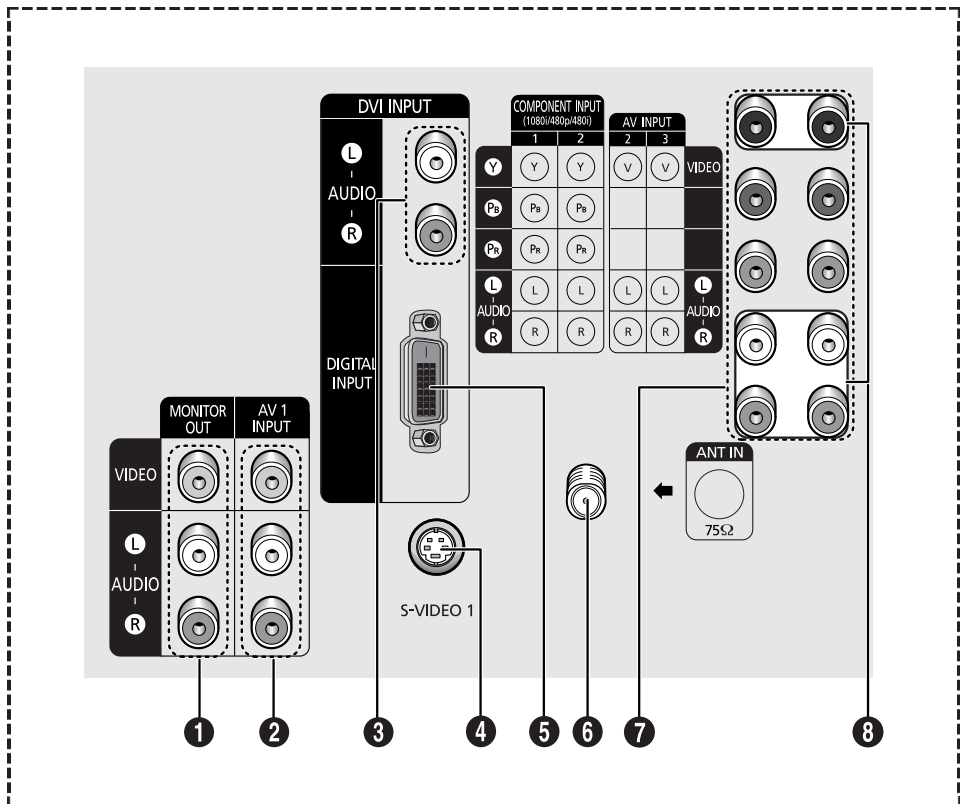

1 AUDIO-VIDEO MONITOR OUTPUT jacks

These audio-video signals are identical to A/V signals being displayed on the big screen. (Typically used as the input signals for a recording VCR.)

2, 8 VIDEO/AUDIO INPUT jacks

Video and Audio signals from VCRs, DVD players and similar devices.
Note: The common jack of component 1 and AV2, component 2 and AV3 input jacks are exclusive relation with each other.

3 DVI AUDIO INPUT jacks

Receives the digital audio signals from a set top box.

4 SUPER VIDEO INPUT jack

S-Video signal from an S-VHS VCR or DVD player.
Note: In S-Video mode, Audio Output depends what kind of audio input source is connected to the side audio input jacks (AV1).

5 DIGITAL INPUT (Digital Visual Interface) jack

Receives the digital video signals from a set top box.

6 VHF/UHF

Connect to an antenna or to a cable TV system.

7 COMPONENT 1, 2 INPUT jacks (480i/480p/1080i)

Connect to the audio and component output jacks of a DVD player or Set-Top Box.
Note: Only black and white signals are output from a monitor in DVD/DTV mode.

Remote Control

You can use the remote control up to about 23 feet from the TV. When using the remote, always point it directly at the TV.

You can also use your remote control to operate your Set-Top Box, VCR, DVD and cable box. See page 63 for details.

1 POWER

Turns the TV on and off.

2 S.MODE

Adjust the TV sound by selecting one of the preset factory settings (or select your personal, customized sound settings).

3 P.MODE

Adjust the TV picture by selecting one of the preset factory settings (or select your personal, customized picture settings).

4 Number buttons

Press to select channels directly on the TV.

+100

Press to select channels over 100. For example, to select channel 121, press "+100," then press "2" and "1."

5 VOL -, VOL +

Press to increase or decrease the volume.

6 MUTE

Press to temporarily cut off the sound.

7 SLEEP

Press to select a preset time interval for automatic shutoff.

8 MENU

Displays the main on-screen menu.

9 P.SIZE

Press to change the screen size.

10 R.SURF

Press the R.SURF button to automatically return to a preferred channel after a user-preset time delay.

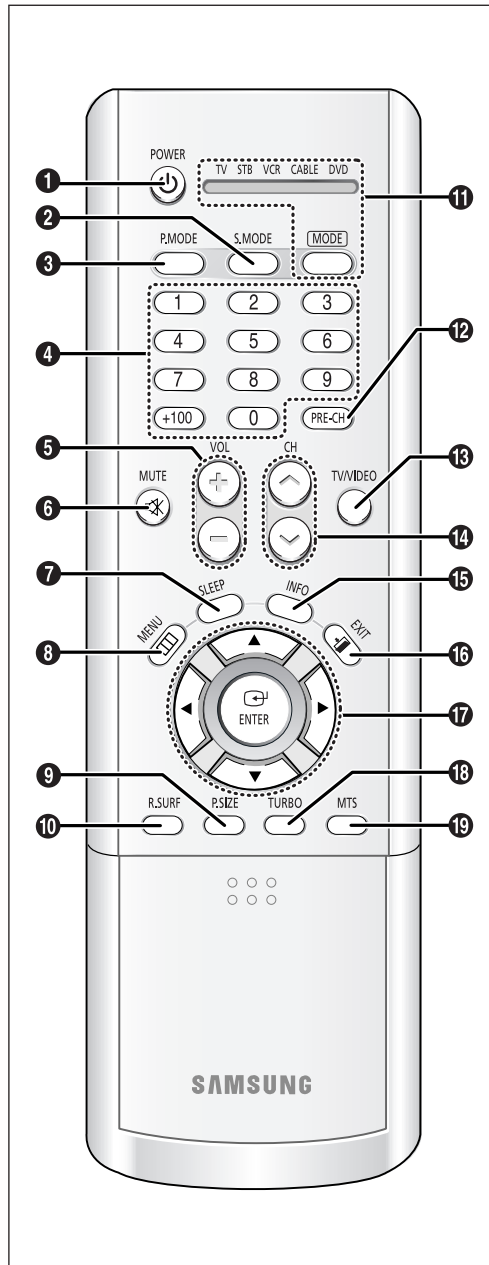

11 MODE

Selects a target device to be controlled by the Samsung remote control (i.e., TV, Set Top Box, VCR, Cable box, or DVD).

12 PRE-CH

Tunes to the previous channel.

13 TV/VIDEO

Press to display all of the available video sources (i.e., Antenna/Cable, VCR).

14 CH ^ and CH v (Channel Up/Down)

Press CH ^ or CH v to change channels.

15 INFO

Press to see the time, channel, etc., on-screen.

16 EXIT

Press to exit the menu.

17 Up, Down, Left, Right (▲, ▼, ◀, ▶) / ENTER

Press to select highlight up, down, left, or right. While using the on-screen menus, press ENTER to activate (or change) a particular item.

18 TURBO

Press to turn the TURBO sound On or Off.

19 MTS (Multichannel Television Stereo)

Press to choose stereo, mono or Separate Audio Program (SAP broadcast).

YOUR NEW TV

Remote Control

20 TV/COMPONENT

Press to switch the TV, COMPONENT1, 2, or DVI mode

21 VCR(DVD, DVR or STB) Controls

REW (Rewind)

Press to rewind a tape in your VCR(DVD, DVR or STB).

STOP

Press this button to stop a tape during play, record, rewind or fast forward. If the button is pressed during Full-Automatic play, the function will be cancelled.

PLAY/PAUSE

Press the PLAY/PAUSE button to play back prerecorded tapes or pause the tape.

FF

Press to fast forward the tape in your VCR(DVD, DVR or STB).

22 SET

Use this button when you are setting up your remote control to operate your Set Top Box, VCR, Cable box or DVD.

23 STILL

Press to stop the action during a particular scene. Press again to resume normal video.
Note: The still function doesn't operate in Component 1, 2 or DVI mode.

24 RESET

If your remote control is not functioning properly, take out the batteries and press the reset button for about 2-3 seconds. Re-insert the batteries and try using the remote control again.

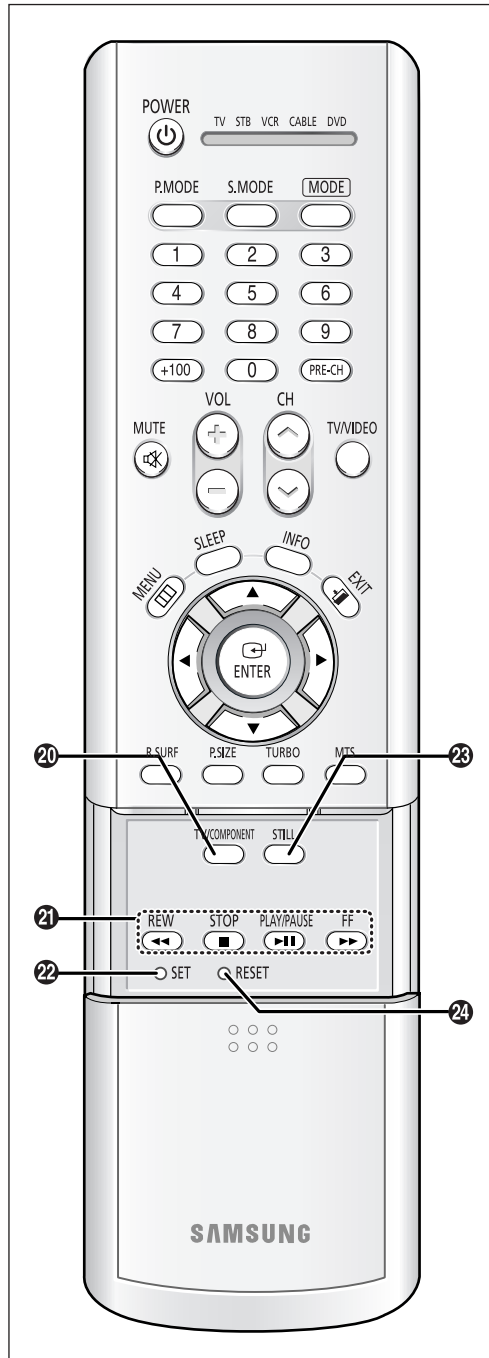

Chapter Two

INSTALLATION

Connecting VHF and UHF Antennas

If your antenna has a set of leads that look like this, see “Antennas with 300-ohm Flat Twin Leads” below.

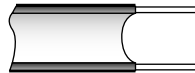

If your antenna has one lead that looks like this, see “Antennas with 75-ohm Round Leads” on next page.



If you have two antennas, see “Separate VHF and UHF Antennas” on next page.

Antennas with 300-ohm Flat Twin Leads

If you are using an off-air antenna (such as a roof antenna or “rabbit ears”) that has 300-ohm twin flat leads, follow the directions below.

1

Place the wires from the twin leads under the screws on the 300-75 ohm adaptor (not supplied). Use a screwdriver to tighten the screws.

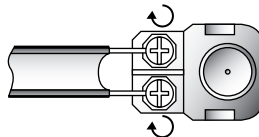

2

Plug the adaptor into the VHF/UHF terminal on the bottom of the back panel.

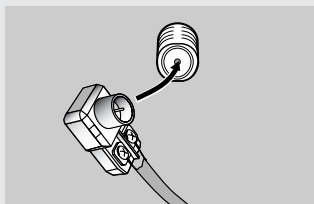

INSTALLATION

Antennas with 75-ohm Round Leads

1

Plug the antenna lead into the VHF/UHF terminal on the bottom of the back panel.

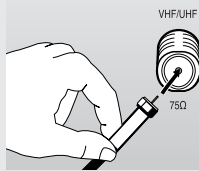

Separate VHF and UHF Antennas

If you have two separate antennas for your TV (one VHF and one UHF), you must combine the two antenna signals before connecting the antennas to the TV. This procedure requires an optional combiner-adaptor (available at most electronics shops).

1

Connect both antenna leads to the combiner.

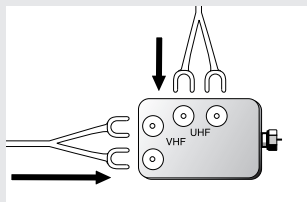

2

Plug the combiner into the VHF/UHF terminal on the bottom of the rear panel.

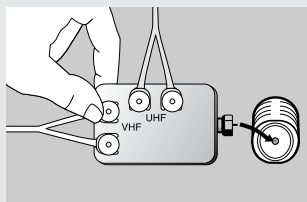

Connecting Cable TV

To connect to a cable TV system, follow the instructions below.

Cable without a Cable Box

1

Plug the incoming cable into the VHF/UHF antenna terminal on back of the TV.

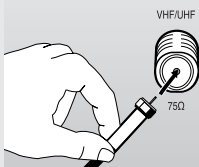

◀ Because this TV is cable-ready, you do not need a cable box to view unscrambled cable channels.

INSTALLATION

Connecting to a Cable Box that Descrambles All Channels

1

Find the cable that is connected to the ANTENNA OUT terminal on your cable box.

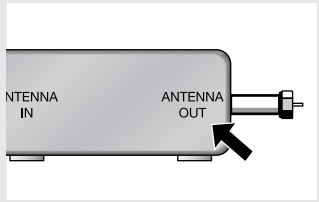

◀ This terminal might be labeled "ANT OUT", "VHF OUT" or simply, "OUT".

2

Connect the other end of this cable to the VHF/UHF antenna terminal on the back of the TV.

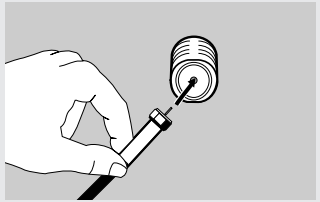

Connecting to a Cable Box that Descrambles Some Channels

If your cable box descrambles only some channels (such as premium channels), follow the instructions below. You will need a two-way splitter, an RF (A/B) switch, and four lengths of coaxial cable. (These items are available at most electronics stores.)

1

Find and disconnect the cable that is connected to the ANTENNA IN terminal on your cable box.

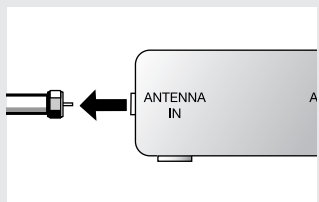

◀ This terminal might be labeled "ANT IN", "VHF IN" or simply, "IN".

2

Connect this cable to a two-way splitter.

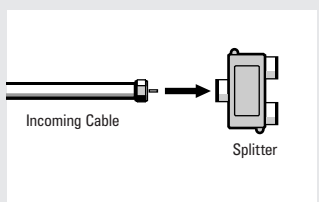

3

Connect a coaxial cable between an OUTPUT terminal on the splitter and the IN terminal on the cable box.

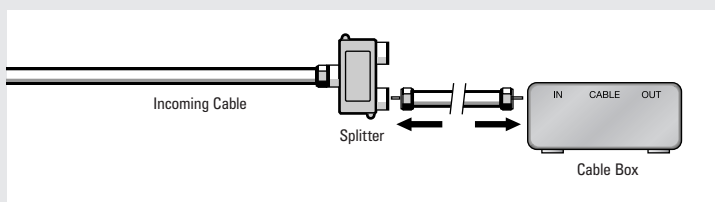

INSTALLATION

4

Connect a coaxial cable between the ANTENNA OUT terminal on the cable box and the B-IN terminal on the RF(A/B) switch.

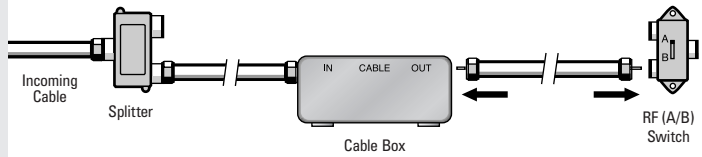

5

Connect another cable between the other OUT terminal on the splitter and the A-IN terminal on the RF (A/B) switch.

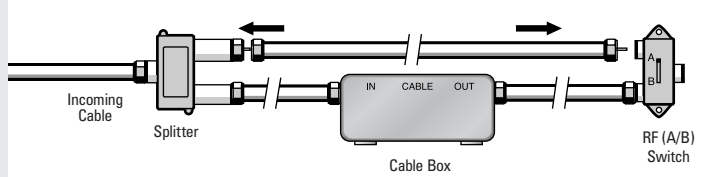

6

Connect the last coaxial cable between the OUT terminal on the RF (A/B) switch and the VHF/UHF terminal on the rear of the TV.

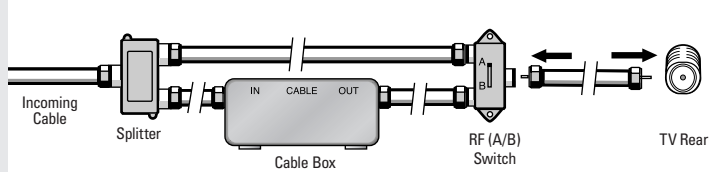

After you've made this connection, set the A/B switch to the "A" position for normal viewing. Set the A/B switch to the "B" position to view scrambled channels. (When you set the A/B switch to "B", you will need to tune your TV to the cable box's output channel, which is usually channel 3 or 4.)

Connecting a VCR

These instructions assume that you have already connected your TV to an antenna or a cable TV system (according to the instructions on pages 11-14). Skip step **1** if you have not yet connected to an antenna or a cable system.

1

Unplug the cable or antenna from the back of the TV.

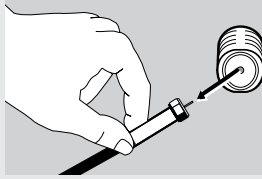

2

Connect the cable or antenna to the ANTENNA IN terminal on the back of the VCR.

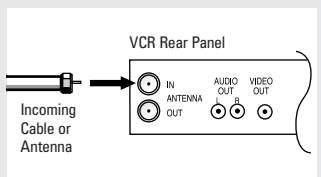

3

Connect a coaxial cable between the ANTENNA OUT terminal on the VCR and the antenna terminal on the TV.

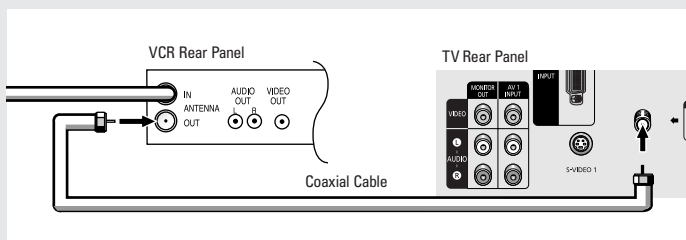

A coaxial cable is usually included with a VCR. (If not, check your local electronics store).

4

Connect a set of audio cables between the AUDIO OUT jacks on the VCR and the AUDIO jacks on the TV.

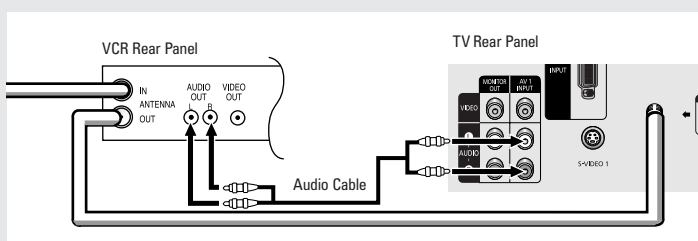

5

Connect a video cable between the VIDEO OUT jack on the VCR and the VIDEO jack on the TV.

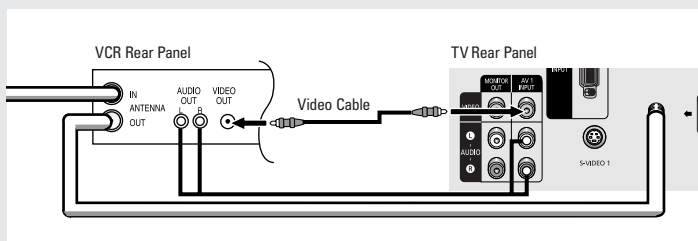

Follow the instructions in "Viewing an External Signal Source" to view your VCR tape.

Connecting an S-VHS VCR

Your Samsung TV can be connected to an S-Video signal from an S-VHS VCR. (This connection delivers a better picture as compared to a standard VHS VCR.)

1

To begin, follow steps 1–3 in the previous section to connect the antenna or cable to your VCR and your TV.

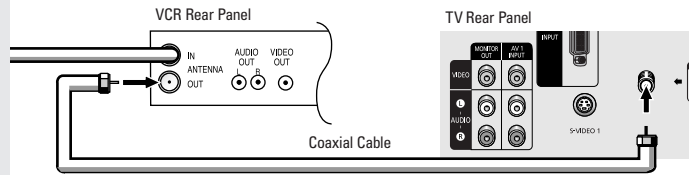

2

Connect a set of audio cables between the AUDIO OUT jacks on the VCR and the 1 AUDIO INPUT jacks on the TV.

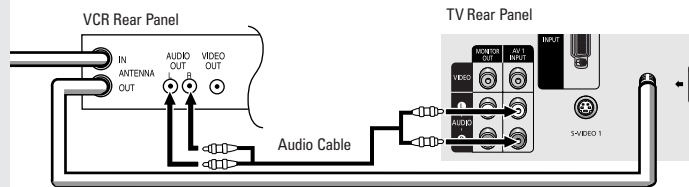

Make sure the jacks you are using are underneath the number “1.”

3

Connect an S-video cable between the S-VIDEO OUT jack on the VCR and the S-VIDEO INPUT jack on the TV.

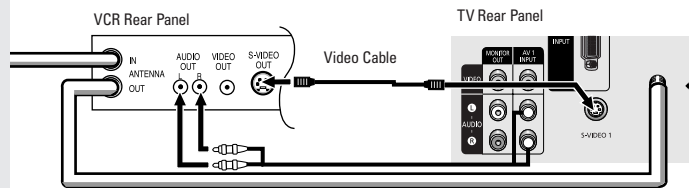

An S-video cable is usually included with an S-VHS VCR (If not, check your local electronics store.)

INSTALLATION

Connecting a Second VCR to Record from the TV

Your TV can send out signals of its picture and sound to be recorded by a second VCR. To do this, connect your second VCR as follows:

1

Connect a set of audio cables between the AUDIO OUT jacks on the TV and the AUDIO IN jacks on the VCR.

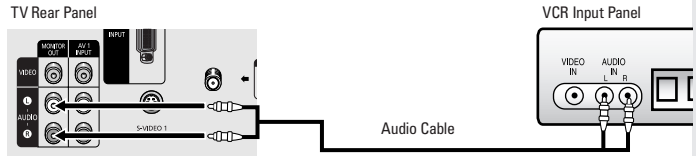

(The VCR input jacks might be either on the front or on back of the VCR.)

2

Connect a video cable between the VIDEO OUT jack on the TV and the VIDEO IN jack on the VCR.

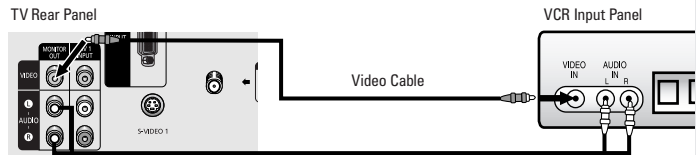

Refer to your VCR's instructions for more information about how to record using this kind of connection.

Connecting a DVD Player (480i)

The rear panel jacks on your TV make it easy to connect a DVD player to your TV.

1

Connect a set of audio cables between the COMPONENT INPUT 1 (L, R) or COMPONENT INPUT 2 (L, R) jacks on the TV and the AUDIO OUT jacks on the DVD player.

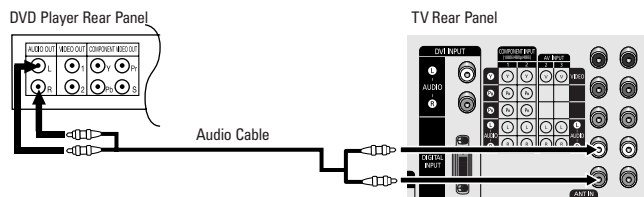

2

Connect a video cable between the COMPONENT INPUT 1 (Y, P_B, P_R) or COMPONENT INPUT 2 (Y, P_B, P_R) jacks on the TV and the COMPONENT VIDEO OUT (Y, P_B, P_R) jacks on the DVD player.

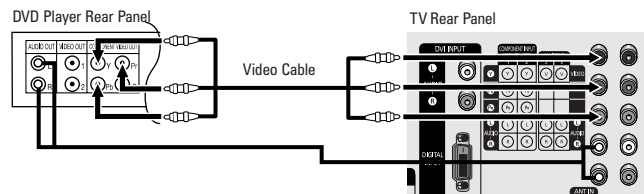

Note: For an explanation of Component video, see your DVD player's owner's manual.

Connecting a Digital TV Set-Top Box (480p/1080i)

Connecting to Y,P_B,P_R

Connect the Y, P_B, and P_R video outputs of the set-top box to their corresponding inputs on the TV. Next, connect the Left and Right audio from the set-top box to the corresponding L and R terminals on the TV. (The connections for a typical set-top box are shown below.)

1

Connect a coaxial cable between the ANTENNA OUT terminal on the Set Top Box and the antenna terminal on the TV.

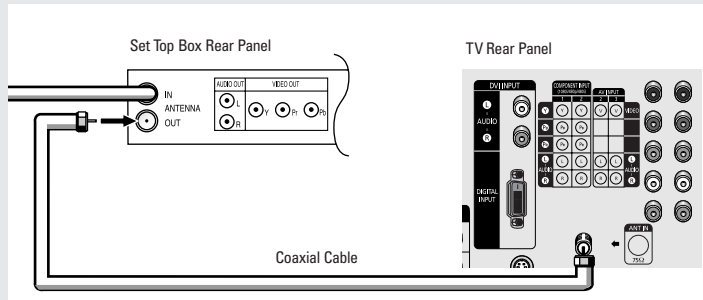

2

Connect a set of audio cables between the COMPONENT INPUT 2 (L, R) or COMPONENT INPUT 1 (L, R) jacks on the TV and the AUDIO OUT jacks on the Set Top Box.

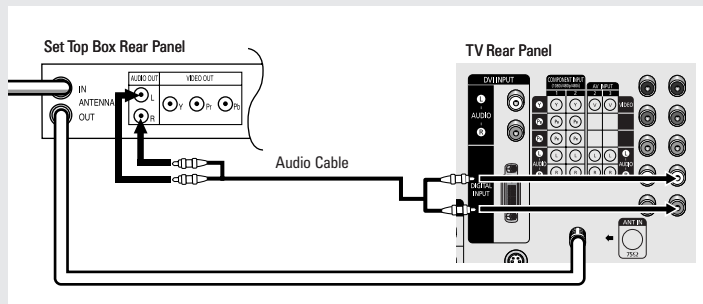

3

Connect a video cable between the COMPONENT INPUT 2 (Y, P_B, P_R) or COMPONENT INPUT 1 (Y, P_B, P_R) jacks on the TV and the VIDEO OUT (Y, P_B, P_R) jacks on the Set Top Box.

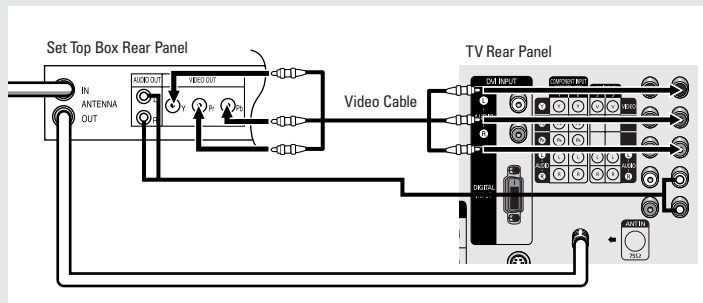

Note: For detailed information, refer to the Set Top Box instruction manual.

Connecting to DVI (Digital Visual Interface)

By inputting a high-bandwidth Digital Content Protection high-definition picture source to the DIGITAL INPUT jack on the TV, high-definition pictures can be displayed on the screen in their digital form. (This DIGITAL INPUT jack is for use in the future when High-bandwidth Digital Content Protection DTV decoders, DVD players and D-VHS are put on the market.)

1

Connect a coaxial cable between the ANTENNA OUT terminal on the Set Top Box and the antenna terminal on the TV.

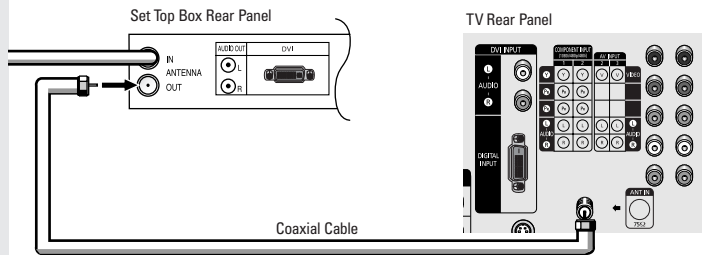

2

Connect a set of audio cables between the AUDIO INPUT jacks on the TV and the AUDIO OUT jacks on the Set Top Box.

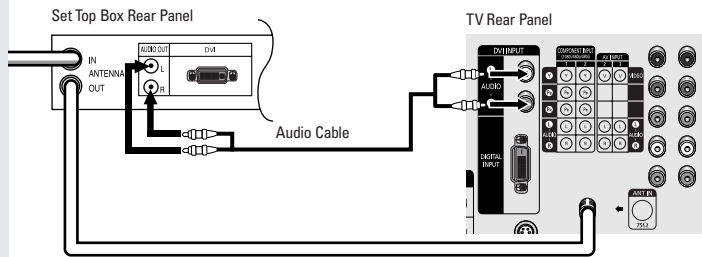

3

Connect a DVI cable between the DIGITAL INPUT jack on the TV and the DVI OUT jack on the Set Top Box.

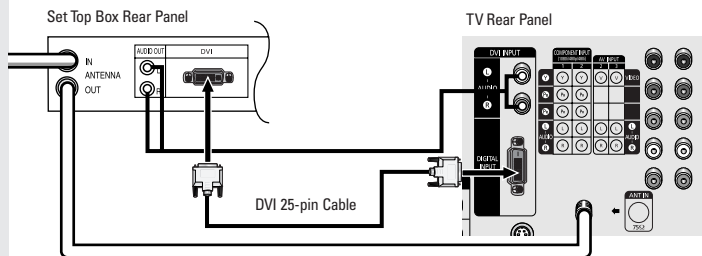

Notes

- The DIGITAL INPUT jack can only be used with 1080i and 480p picture signals. Set the DTV decoder DIGITAL OUTPUT jack output setting to 1080I OR 480P. For detailed information, refer to the Set Top Box instruction manual.
- The DIGITAL INPUT jack is not compatible with the picture signal of a personal computer.
- Use a DVI 25-pin cable (commercially available) in order to digitally connect the TV with a DTV decoder.

Connecting a Camcorder

The side panel jacks on your TV make it easy to connect a camcorder to your TV. They allow you to view the camcorder tapes without using a VCR. (Also see “Viewing an External Signal Source” on page 39).

1

Locate the A/V output jacks on the camcorder. They are usually found on the side or back of the camcorder.

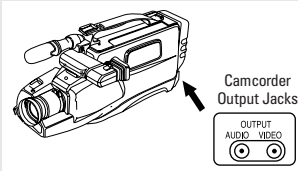

2

Connect an audio cable between the AUDIO OUTPUT jack on the camcorder and the AUDIO terminals on the side of the TV.

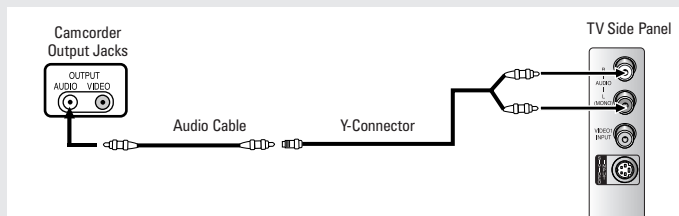

3

Connect a video cable between the VIDEO OUTPUT jack on the camcorder and the VIDEO terminal on the side of the TV.

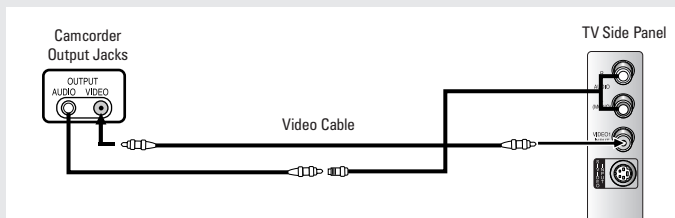

The audio-video cables shown here are usually included with a Camcorder. (If not, check your local electronics store.) If your camcorder is stereo, you need to connect a set of two cables.

Installing Batteries in the Remote Control

1

Slide the cover out completely.

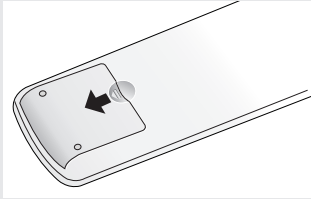

2

Install two AAA size batteries.

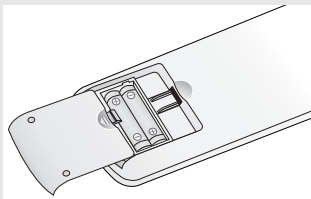

◀ Make sure to match the “+” and “-” ends of the batteries with the diagram inside the compartment.

3

Replace the cover.

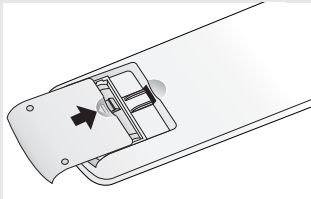

◀ Remove the batteries and store them in a cool, dry place if you won't be using the remote control for a long time.

The remote control can be used up to about 23 feet from the TV.

(Assuming typical TV usage, the batteries last for about one year.)

Chapter Three

OPERATION

Turning the TV On and Off

Press the **POWER** button on the remote control.

You can also use the **POWER** button on the front panel.

Plug & Play Feature

When the TV is initially powered On, five basic customer settings proceed automatically and subsequently: Setting the language, Video signal source, Anf. input check, Auto program and Clock.

1

Press the **POWER** button on the remote control.

The message "Plug & Play" is displayed. It flickers for a little while and then the "Language" menu is automatically displayed.

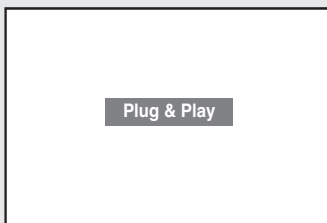

2

Press the ◀ or ▶ button to select the desired language.

Press the **MENU** button to enter the language, then the "Channel" menu is automatically displayed.

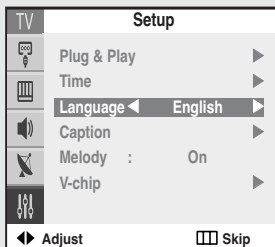

3

Press the ◀ or ▶ button to select the desired video signal source. Press the **MENU** button to enter the video signal source, then the "Check antenna input." is automatically displayed.

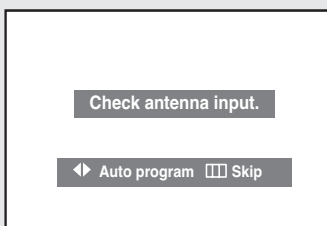
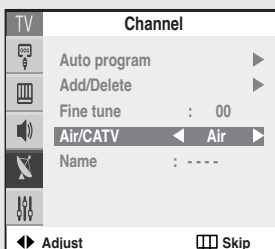

OPERATION

4

Make sure that the antenna is connected to the TV. And then press the ◀ or ▶ button to activate "Auto Program" or press the **MENU** button to skip. (refer to "Auto program" on page 27.)

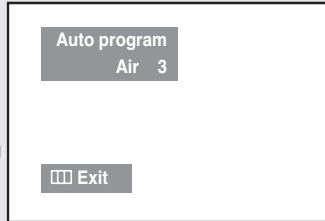

5

Press the ▶ button to move to the hour or minute. Set the hour or minute by pressing the ▲ or ▼ button. (refer to "Setting the Clock" on page 31.)

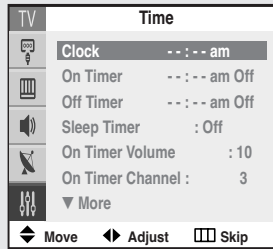

6

When you have finished, press the **MENU** button. The message "Enjoy your watching.." is displayed.

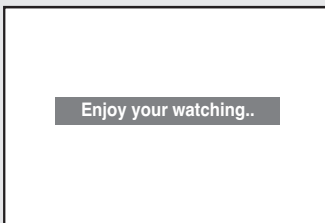

7

If you want to reset this feature
(1) Press the **MENU** button.
(2) Press the ▲ or ▼ button to select the "Setup", then press the **ENTER** button.
(3) Press the **ENTER** button to select "Plug & Play".
The message "Plug & Play" is displayed.

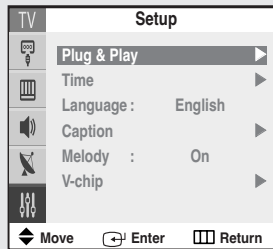

Note: Plug & Play feature doesn't work when the V-chip is on or when in the A/V mode.

Viewing the Menus and On-Screen Displays

Viewing the Menus

1

With the power on, press the **MENU** button.

The main menu appears on the screen. Its left side has five icons: Input, Picture, Sound, Channel and Setup.

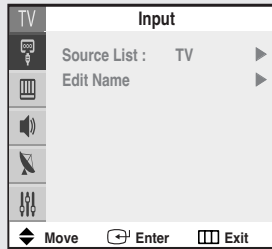

◀ The on-screen menus disappear from the screen after two minutes.

2

Use the ▲ and ▼ buttons to highlight one of the 5 icons. Then press the **ENTER** button to access the icon's sub-menu.

3

Press the **EXIT** button to exit the menu.

◀ You can also use the MENU, CH and VOL buttons on the control panel of the TV to make selections.

Viewing the Display

1

Press the **INFO** button.

The on-screen display shows any or all of the following: Active channel, the channel label, signal, MTS and the current time.

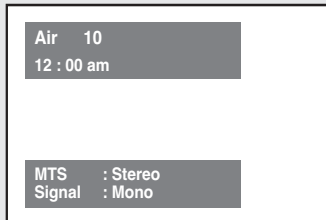

◀ The on-screen displays disappear after ten seconds.

Selecting a Menu Language

1

Press the **MENU** button to display the menu.

Press the **▲** or **▼** button to select "Setup", then press the **ENTER** button.

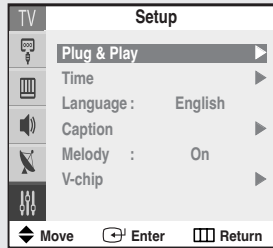

2

Press the **▲** or **▼** button to select "Language".

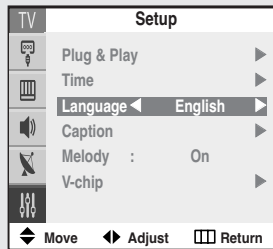

3

Press the **◀** or **▶** button to select the appropriate language: "English", "Español" or "Français".

Press the **EXIT** button to exit the menu.



Memorizing the Channels

Your TV can memorize and store all of the available channels for both “off-air” (antenna) and cable channels. After the available channels are memorized, use the CH \wedge and CH \vee buttons to scan through the channels. This eliminates the need to change channels by entering the channel digits. There are three steps for memorizing channels: selecting a broadcast source, memorizing the channels (automatic) and adding and deleting channels (manual).

Selecting the Video Signal-source

Before your television can begin memorizing the available channels, you must specify the type of signal source that is connected to the TV (i.e., an antenna or a cable system).

1

Press the **MENU** button to display the menu.

Press the \blacktriangle or \blacktriangledown button to select “Channel”, then press the **ENTER** button

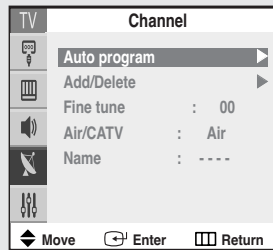

2

Press the \blacktriangle or \blacktriangledown button to select “Air/CATV”.

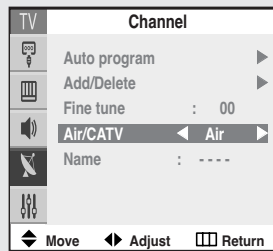

3

Repeatedly press the \blacktriangleleft or \blacktriangleright button to cycle through these choices: “Air” (antenna) “STD”, “HRC” or “IRC” (all cable TV).

Press the **EXIT** button to exit the menu.

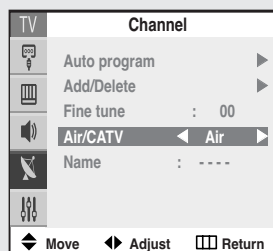

Note: STD, HRC and IRC identify various types of cable TV systems. Contact your local cable company to identify the type of cable system that exists in your particular area.

At this point the signal source has been selected. Proceed to “Storing Channels in Memory” (next page).

Storing Channels in Memory (Automatic Method)

1

First, select the correct signal source (Air, STD, HRC, IRC). See steps 1~3 on previous page.

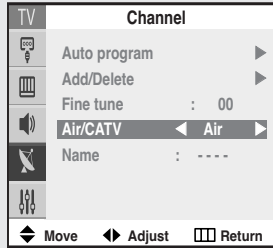

2

Press the ▲ or ▼ button to select "Auto Program".

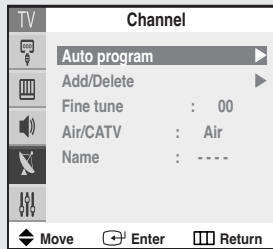

3

Press the **ENTER** button. The TV will begin memorizing all of the available channels.

After all the available channels are stored, the channel menu reappears.

Press the **EXIT** button to exit the menu.

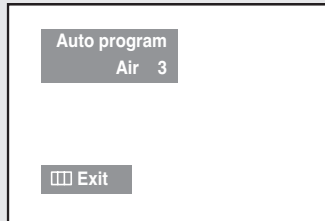

◀ The TV automatically cycles through all of the available channels and stores them in memory. This takes about one to two minutes.

Adding and Erasing Channels (Manual Method)

First, press the CH \wedge or CH \vee button or the number buttons to select the channel you want to add or delete.

1

Press the **MENU** button to display the menu.

Press the \blacktriangle or \blacktriangledown button to select "Channel", then press the **ENTER** button.

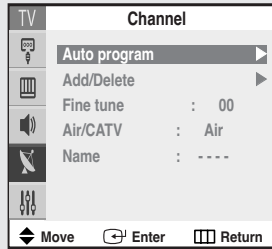

2

Press the \blacktriangle or \blacktriangledown button to select "Add/Delete", then press the **ENTER** button.



3

Press the \blacktriangleleft or \blacktriangleright button or the number buttons to select the channel you want to add or delete.

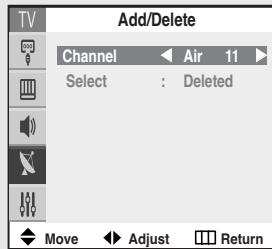

4

Press the \blacktriangle or \blacktriangledown button to select "Select", then press the \blacktriangleleft or \blacktriangleright button to select "Added" or "Deleted".

Press the **EXIT** button to exit the menu.

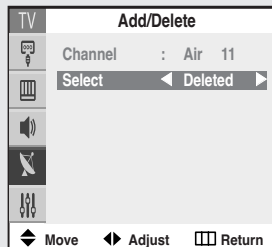

Changing Channels

Using the Channel Buttons

Press the **CH** \wedge or **CH** \vee button to change channels.

When you press CH \wedge or CH \vee , the TV changes channels in sequence. You will see all the channels that the TV has memorized. (The TV must have memorized at least three channels.) You will not see channels that were either erased or not memorized.

Directly Accessing Channels

Use the number buttons to quickly tune to any channel.

Press the number buttons to go directly to a channel. For example, to select channel 27, press "2" then "7". The TV will change channels when you press the second number.

When you use the number buttons, you can directly select channels that were either erased or not memorized.

To select a channel over 100, press the +100 button. (For channel 122, press "+100" then "2" then "2".)

To change to single-digit channels (0–9) faster, press "0" before the single digit. (For channel "4" press "0" then "4".)

Using the PRE-CH Button to select the Previous Channel

Press the **PRE-CH** button.
The TV will switch to the last channel viewed.

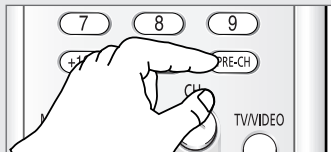

◀ To quickly switch between two channels that are far apart, tune to one channel, then use the number button to select the second channel. Then, use the PRE-CH button to quickly alternate between them.

Labeling the Channels

Use this feature to assign an easy-to-remember label to any channel (i.e., “CBS”, “ESPN”, “PBS2”, CNN1”, etc.) A label consists of four fields, where each field is a letter, a number, “*”, or a blank. When the INFO button is pressed, the channel label will appear next to the channel number.

1

Press the **CH** \wedge or **CH** \vee button to tune to the channel that will be labeled.

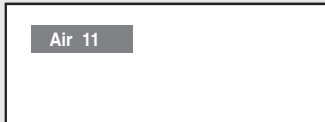

2

Press the **MENU** button to display the menu.

Press the \blacktriangle or \blacktriangledown button to select “Channel”, then press the **ENTER** button.



◀ Note: You cannot select “Name” in the AV mode.

3

Press the \blacktriangle or \blacktriangledown button to select “Name”.
Press the \blacktriangleright button to begin labeling. The left-most field will be highlight.
(Each label has four fields. See top paragraph.)

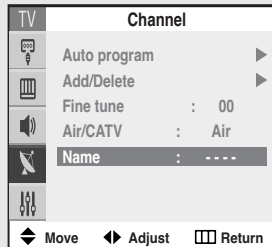

4

Press the \blacktriangle or \blacktriangledown button to select a letter, a number, “*” or a blank. (Pressing \blacktriangle or \blacktriangledown button results in this sequence: A, B,...Z, *, blank, 0, 1, ...9).

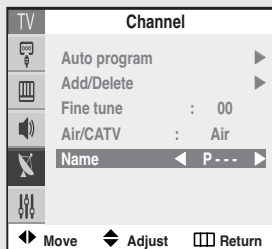

5

Press the \blacktriangleright button to switch to the next field, which will be high-light.
Select a second letter or digit using the \blacktriangle or \blacktriangledown button, as above.
Repeat the process to select the last two digits.

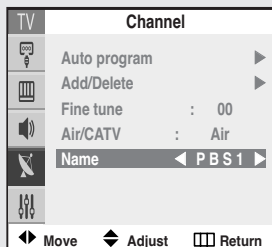

Press the **EXIT** button to exit the menu.

Setting the Clock

Setting the clock is necessary in order to use the various timer features of the TV. Also, you can check the time while watching the TV. (Just press the INFO button.)

Option 1: Setting the Clock Manually

1

Press the **MENU** button to display the menu.

Press the **▲** or **▼** button to select "Setup", then press the **ENTER** button.

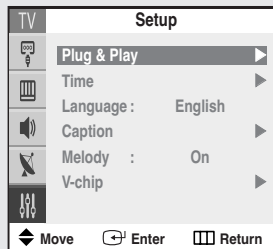

2

Press the **▲** or **▼** button to select "Time", then press the **ENTER** button.

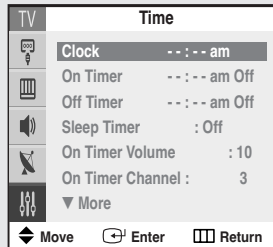

3

Press the **◀** or **▶** button to move to "Hour" or "Minute".

Set the clock you want by pressing the **▲** or **▼** button, then press the **▶** button.

Press the **EXIT** button to exit the menu.

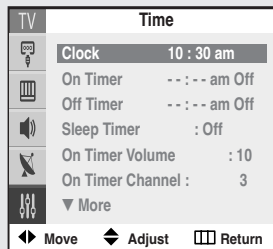

◀ When selecting the hours, be sure to select the proper time of day (am or pm).

You can change the hours by pressing the **▲** or **▼** button repeatedly (or by holding down either of these buttons).

The current time will appear every time you press the **INFO** button.

Option 2: Setting the Clock Automatically

The Clock can be set automatically if you are receiving a digital signal.

1

Press the **MENU** button to display the menu.

Press the **▲** or **▼** button to select "Setup", then press the **ENTER** button.

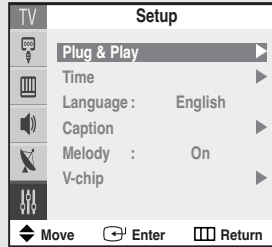

2

Press the **▲** or **▼** button to select "Time", then press the **ENTER** button.

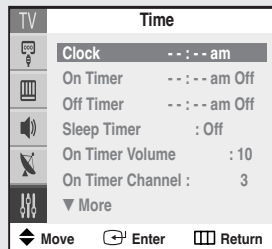

3

Press the **▲** or **▼** button to select "Auto Clock Set", then press the **ENTER** button.



4

Press the **◀** or **▶** button to select "On".

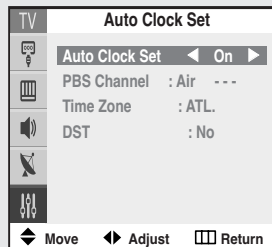

◀ Certain broadcasts may not transmit the correct time. In this case, set the time manually.

OPERATION

5

Press the ▲ or ▼ button to select "PBS Channel", then press the ◀ or ▶ button to select your local PBS channel.

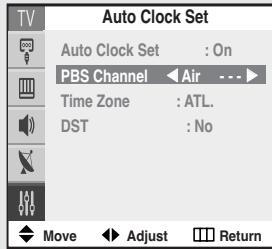

6

Press the ▲ or ▼ button to select "Time Zone", then press the ◀ or ▶ button to select the time zone for your local area.

ATL. : Atlantic
EAST : Eastern
CEN. : Central
MTN. : Mountain
PAC. : Pacific
ALAS. : Alaska
HAW. : Hawaii

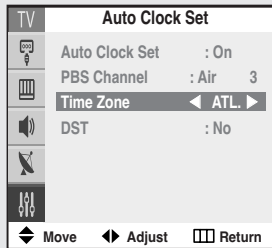

7

Press the ▲ or ▼ button to select "DST" (Daylight Saving Time), then press the ◀ or ▶ button to select "Yes" or "No".

Press the EXIT button to exit the menu.

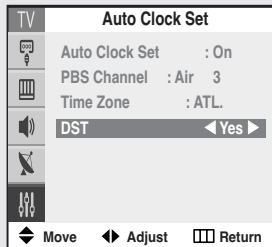

◀ The set time can be changed according to the broadcasting station and signal when you set up auto time.

If there is a difference between the real time and set time, please set up manual time.

Customizing the Picture

You can use the on-screen menus to change the Contrast, Brightness, Sharpness, Color, Tint and according to personal preference. (Alternatively, you can use one of the “Automatic” settings. See next page.)

1

Press the **MENU** button to display the menu.

Press the **▲** or **▼** button to select “Picture”, then press the **ENTER** button.

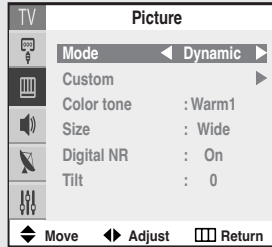

2

Press the **▲** or **▼** button to select “Custom”, then press the **ENTER** button. (The words Contrast, Brightness, Sharpness, Color and Tint will appear on the screen.)

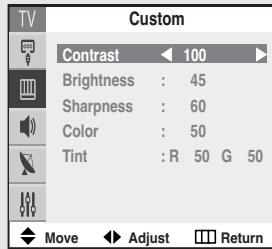

3

Press the **▲** or **▼** button to select a particular item.

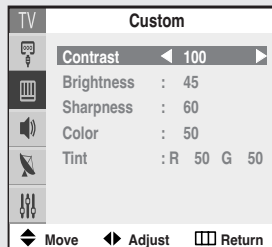

4

Press the **◀** or **▶** button to increase or decrease the value of a particular item.

For example, if you select “Contrast”, pressing the **▶** button increases it.

Press the **EXIT** button to exit the menu.



◀ After adjusting an item, the gauge will automatically disappear (after about 10 seconds).

Using Automatic Picture Settings

Your TV has three automatic picture settings (“Dynamic”, “Standard” and “Movie”) that are preset at the factory. You can activate either Dynamic, Standard, Movie or Custom by pressing the PMODE button (or by making a selection from the menu). Or, you can select “Custom” which automatically recalls your personalized picture settings.

1

Press the **MENU** button to display the menu.

Press the **▲** or **▼** button to select “Picture”, then press the **ENTER** button.

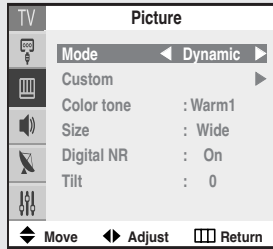

2

Press the **◀** or **▶** button to select the “Dynamic” “Standard” “Movie” or “Custom” picture setting.

Press the **EXIT** button to exit the menu.

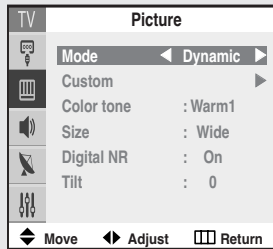

- Choose Dynamic for viewing the TV during the day or when there is bright light in the room.
- Choose Standard for the standard factory settings.
- Choose Movie when viewing the movie.
- Choose Custom if you want to adjust the settings according to personal preference (see “Customizing the Picture”, page 34).

Adjusting the Volume

Press the **VOL +** or **VOL –** button to increase or decrease the volume.

Using the MUTE Button

At any time, you can temporarily cut off the sound using the MUTE button.

1

Press the **MUTE** button and the sound cuts off. The word "Mute" will appear in the lower-left corner of the screen.

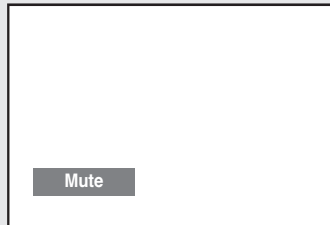
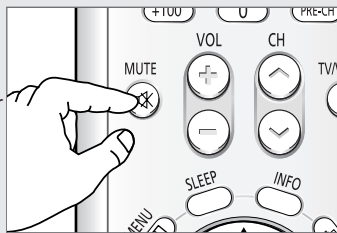

2

To turn mute off, press the **MUTE** button to again, or simply press either the **VOL +** or **VOL –** button.

Customizing the Sound

You can use the on-screen menus to adjust the Equalizer setting, according to individual preference. (Alternatively, you can use one of the “automatic” settings. See next page.)

1

Press the **MENU** button to display the menu.

Press the **▲** or **▼** button to select the “Sound”, then press the **ENTER** button.

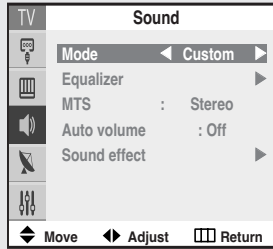

2

Press the **▲** or **▼** button to select “Equalizer”, then press the **ENTER** button.

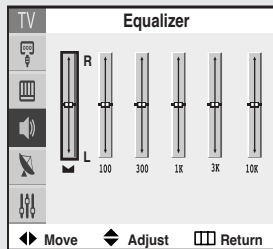

3

Press the **◀** or **▶** button to select a particular item.

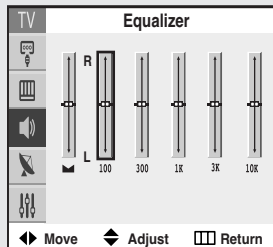

4

Press the **▲** or **▼** button to increase or decrease the value of a particular item.

Press the **EXIT** button to exit the menu.

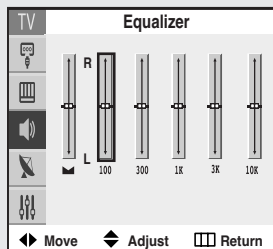

Using Automatic Sound Settings

Your TV has four automatic sound settings (“Standard”, “Music”, “Movie” and “Speech”) that are preset at the factory. You can activate either Standard, Music, Movie or Speech by pressing the S.MODE button (or by making a selection from the menu). Or, you can select “Custom”, which automatically recalls your personalized sound settings.

1

Press the **MENU** button to display the menu.

Press the **▲** or **▼** button to select the “Sound”, then press the **ENTER** button.

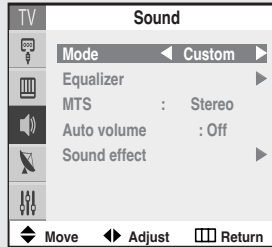

2

Press the **◀** or **▶** button to select the to select the “Standard”, “Music” “Movie”, “Speech” or “Custom” sound settings.

Press the **EXIT** button to exit the menu.

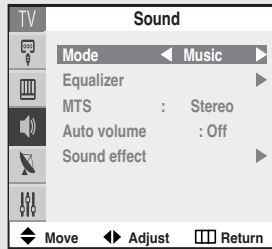

- Choose Standard for the standard factory settings.
- Choose Music when watching music videos or concerts.
- Choose Movie when watching movie.
- Choose Speech when watching a show that is mostly dialogue (i.e., news).
- Choose Custom to recall your personalized settings.
(see “Customizing the Sound”, page 37).

Viewing an External Signal Source

Use the remote control to switch between viewing signals from connected equipment, such as VCRs, DVD, Set-Top Box and the TV source (broadcast or cable).

Setting the Signal Source

1

Press the **MENU** button to display menu, then press the **ENTER** button.

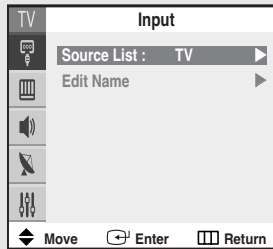

2

Press the **ENTER** button again. Press the **▲** or **▼** button to select signal source, then press the **ENTER** button.

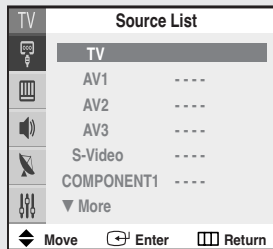

Alternate method:

Simply press the **TV/VIDEO** or **TV/COMPONENT** button on the remote control to select an External Signal Source.



Assigning Names to External input mode

1

Press the **MENU** button to display menu, then press the **ENTER** button.

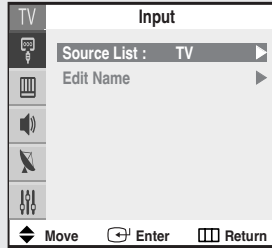

2

Press the **▲** or **▼** button to select the "Edit Name", then press the **ENTER** button.

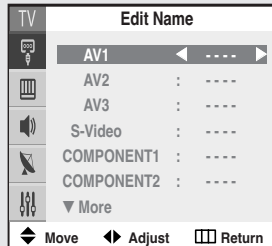

3

Press the **▲** or **▼** button to select the source list.

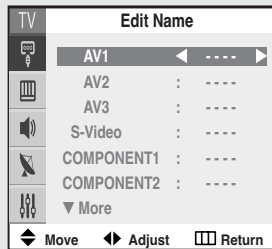

4

Press the **◀** or **▶** button to select external device (VCR, DVD, Cable STB, Sat. STB, AV Recv., DVD Recv., Game, Camcorder, DVD Combo).

Set other signal sources (AV2, AV3, S-Video, COMPONENT1, COMPONENT2, DVI) using the same method as listed above.

Press the EXIT button to exit the menu.

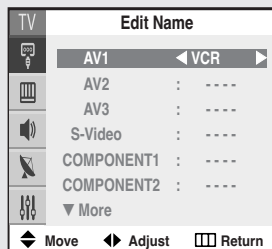

Chapter Four

SPECIAL FEATURES

Fine Tuning Channels

Use fine tuning to manually adjust a particular channel for optional reception.

1

Press the **MENU** button to display the menu.

Press the **▲** or **▼** button to select "Channel", then press the **ENTER** button.

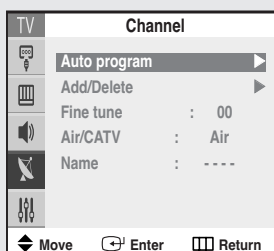

2

Press the **▲** or **▼** button to select "Fine tune".

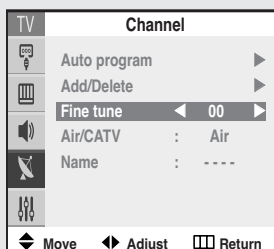

3

Press the **◀** or **▶** button to adjust the fine tuning.

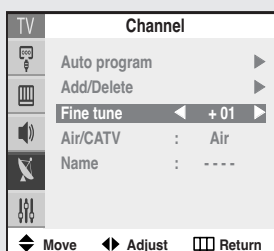

4

To store the fine tuning setting in the TV's memory, press the **▲** button. ("*" will appear).

To reset the fine tuning to "00", press the **▼** button.

Press the **EXIT** button to exit the menu.

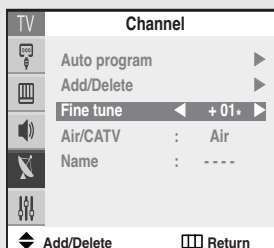

◀ After you adjust the fine tuning, "*" will appear when you press **INFO** while watching this channel.

Changing the Color Tone

1

Press the **MENU** button to display the menu.

Press the **▲** or **▼** button to select "Picture", then press the **ENTER** button.

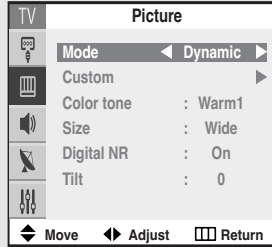

2

Press the **▲** or **▼** button to select "Color tone".

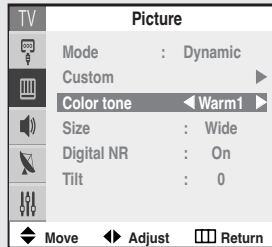

3

Press the **◀** or **▶** button to select "Cool2", "Cool1", "Normal", "Warm1" or "Warm2" according to personal preference.

Press the **EXIT** button to exit the menu.

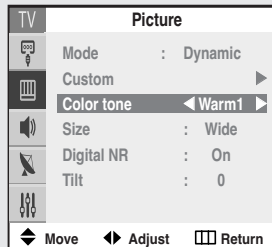

Changing the Screen Size

1

Press the **MENU** button to display the menu.

Press the **▲** or **▼** button to select "Picture", then press the **ENTER** button.

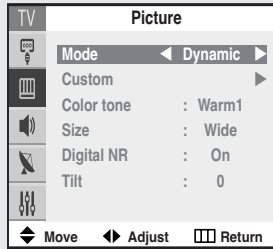

2

Press the **▲** or **▼** button to select "Size".

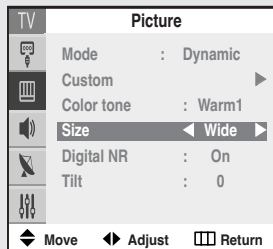

3

Press the **◀** or **▶** button to select "Wide", "Panorama(TX-P2665W/TX-P3066W/TX-P2664W/TX-P3064W)", "Zoom1", "Zoom2", or "4:3".

Press the **EXIT** button to exit the menu.

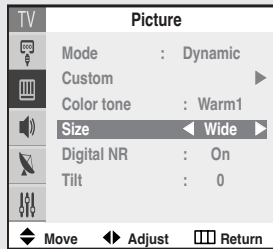

Alternate method:

Simply press the **P.SIZE** button on the remote control to change a screen size.



- **Wide:** Sets the picture to 16:9 wide mode.
- **Panorama:** Use this mode for the wide aspect ratio of a panoramic picture. (TX-P2665W/TX-P3066W/TX-P2664W/TX-P3064W)
- **Zoom1:** Magnifies the size of the picture on screen. You can also move the picture on screen using the **▲** or **▼** button on the remote control.
- **Zoom2:** Magnifies the size of the picture more than Zoom1. You can also move the picture on screen using the **▲** or **▼** button on the remote control.
- **4:3(Normal):** Sets the picture to 4:3 normal mode.

Notes: Screen size cannot be changed in the DVI mode.

Digital Noise Reduction

If the broadcast signal received by your TV is weak, you can activate the Digital Noise Reduction feature to help reduce any static and ghosting that may appear on the screen.

1

Press the **MENU** button to display the menu.

Press the **▲** or **▼** button to select "Picture", then press the **ENTER** button.

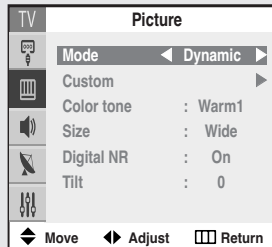

2

Press the **▲** or **▼** button to select "Digital NR".

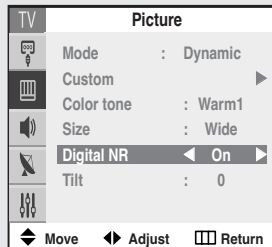

3

Press the **◀** or **▶** button to select "On" or "Off".

Press the **EXIT** button to exit the menu.

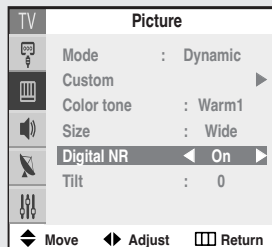

Tilt

Due to the Earth's magnetic field there may be some minor image tilt depending on the TV's location. When this occurs, follow the steps below.

1

Press the **MENU** button to display the menu.

Press the **▲** or **▼** button to select "Picture", then press the **ENTER** button.

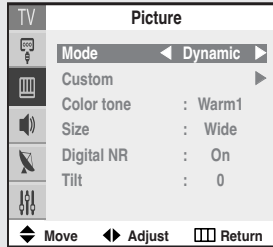

2

Press the **▲** or **▼** button to select "Tilt".

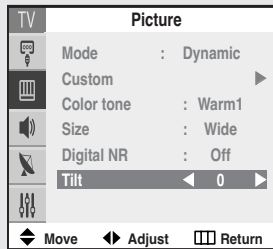

3

Press the **◀** or **▶** button to adjust the Tilt.

Press the **EXIT** button to exit the menu.

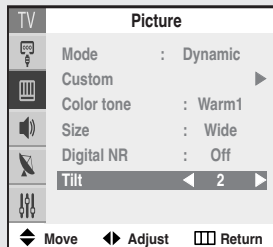

Using the R.Surf Feature

This feature allows you to set the TV to return to a particular channel after a certain amount of time. For example, you may be watching a channel when commercials start. You can set the R.Surf to “5 minutes”, then switch channels. After minutes, the TV will return to the original channel. To use the R.Surf feature:

1

While you are watching the channel to which you want to return, press the **R.SURF** button. The on-screen display will read “Surf off”.

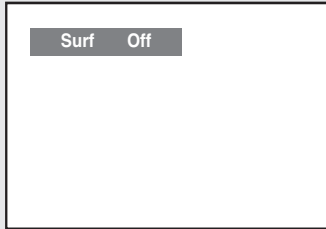

2

Press the **R.SURF** button again to set the timer in thirty second intervals, up to five minutes.

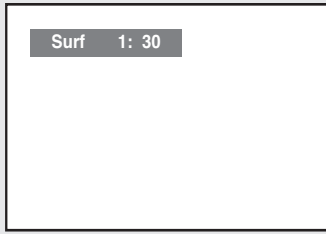

◀ The time will be decreasing while you are setting up the timer. And you will reset it when you pass five minutes or turn it off.

3

The time you set will begin counting down on the screen. When the time runs out, the TV will return to the channel you were watching when you set the timer.

Freezing the Picture

Press the **STILL** button to freeze a moving picture. (normal sound will still be heard.)

Press again to cancel.

◀ Note: The still function doesn't operate in the COMPONENT and DVI mode.

Choosing a Multi-Channel Sound (MTS) Soundtrack

Depending on the particular program being broadcast, you can listen to Stereo, Mono, or a Separate Audio Program. (SAP audio is usually a foreign-language translation. Sometimes SAP has unrelated information like news or weather.)

1

Press the **MENU** button to display the menu.

Press the **▲** or **▼** button to select the "Sound", then press the **ENTER** button.

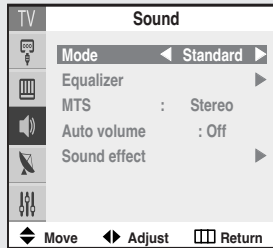

2

Press the **▲** or **▼** button to select "MTS".

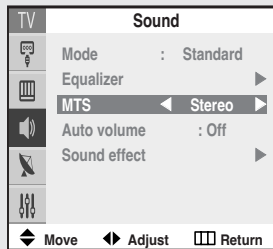

3

Press the **◀** or **▶** button to select "Mono", "Stereo" or "SAP".

Press the **EXIT** button to exit the menu.

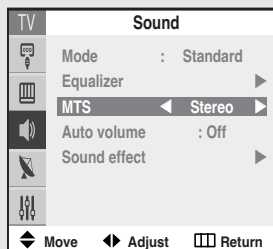

◀ The text at the bottom of the menu tells you if the incoming audio is Mono, Stereo or SAP.

Alternate method:

Simply press the **MTS** button on the remote control to select the MTS setting.



- Choose Mono for channels that are broadcasting in mono, or if you are having difficulty receiving a stereo signal.
- Choose Stereo for channels that are broadcasting in stereo.
- Choose SAP to listen to the Separate Audio Program, which is usually a foreign-language translation.

Adjusting the Volume Automatically

Each broadcasting station has its own signal conditions, which can make it necessary to adjust the volume every time the channel is changed. "Auto volume" lets you automatically adjust the volume of the desired channel by lowering the sound output when the modulation signal is high or by raising the sound output when the modulation signal is low.

1

Press the **MENU** button to display the menu.

Press the **▲** or **▼** button to select the "Sound", then press the **ENTER** button.

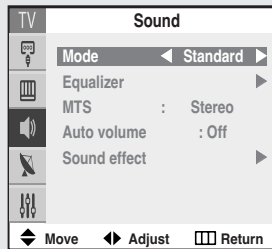

2

Press the **▲** or **▼** button to select "Auto volume".

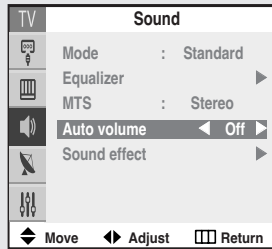

3

Press the **◀** or **▶** button to select "On" or "Off".

Press the **EXIT** button to exit the menu.

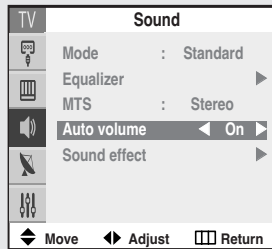

Setting the Surround

Your Samsung TV can create a "surround" effect such that the sound seems to come from all directions. Once the "Surround" is set to "On", the setting applies to sound effects such as Standard, Music, Movie and Speech.

1

Press the **MENU** button to display the menu.

Press the **▲** or **▼** button to select the "Sound", then press the **ENTER** button.

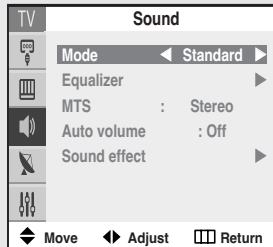

2

Press the **▲** or **▼** button to select "Sound effect" then press the **ENTER** button.

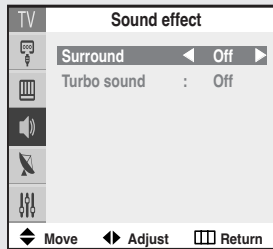

3

Press the **◀** or **▶** button to select "On" or "Off".

Press the **EXIT** button to exit the menu.

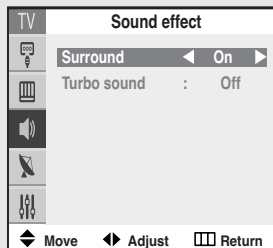

Setting the Turbo Sound

Turbo sound emphasizes the bass and treble frequencies to add fullness to the sound.

1

Press the **MENU** button to display the menu.

Press the **▲** or **▼** button to select the "Sound", then press the **ENTER** button.

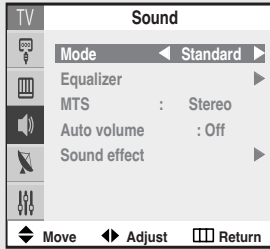

2

Press the **▲** or **▼** button to select "Sound effect" then press the **ENTER** button.

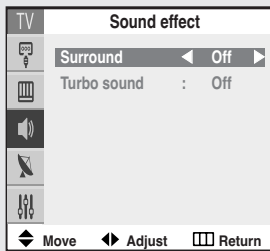

3

Press the **▲** or **▼** button to select "Turbo sound".

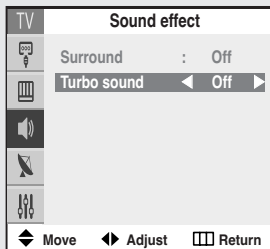

4

Press the **◀** or **▶** button to select "On" or "Off".

Press the **EXIT** button to exit the menu.

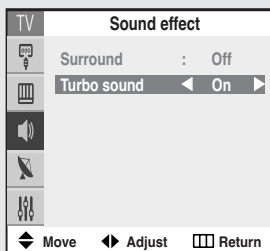

Alternate method:

Simply press the **TURBO** button on the remote control to select the Turbo sound setting.

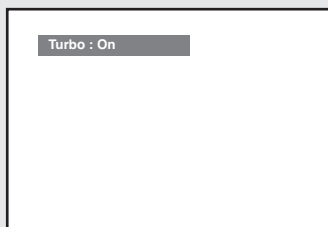

Setting the On/Off Timer

1

Press the **MENU** button to display the menu.

Press the **▲** or **▼** button to select "Setup", then press the **ENTER** button.

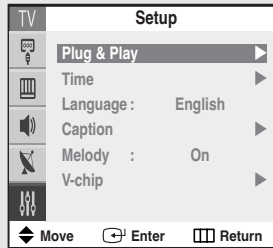

◀ Before using the timer, you must set the TV's clock. (See "Setting the Clock" on page 31).

When any of the timers are set, the "Timer" LED will illuminate (front panel of TV).

2

Press the **▲** or **▼** button to select "Time", then press the **ENTER** button.

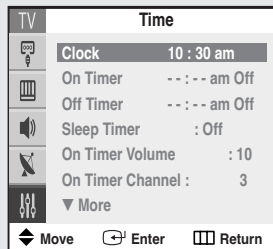

3

Press the **▲** or **▼** button to select "On Timer".

Press the **▶** button to select the hours. (The minutes digits will be highlighted.)

Press the **▲** or **▼** button repeatedly to select the appropriate hours (i.e., the hour when the TV will turn on.)

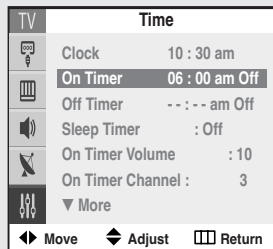

4

Press the **▶** button to select the minutes. (The minutes digits will be highlighted.)

Press the **▲** or **▼** button to select the appropriate minutes.

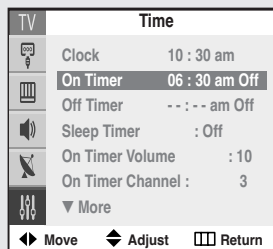

5

Press the **▶** button to select "On" or "Off".

Press the **▲** or **▼** button to turn the on-timer "On". (Repeatedly pressing the **▲** or **▼** button will alternate between "On" and "Off".)

When finished, press the **▶** button.

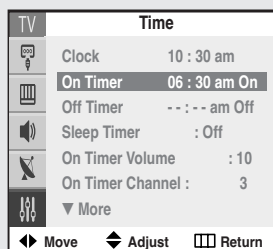

◀ To deactivate the "On Timer," select "Off" during this step.

6

To set the Off Timer, press the ▲ or ▼ button to select "Off Timer". Press the ► button and set the hours and minutes. (Follow the same procedure as in steps 3-5 above.)

When finished setting the timer, Press the EXIT button to exit the menu.

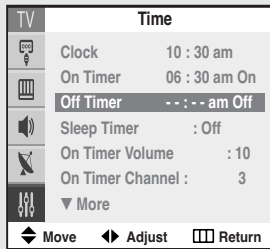

◀ **Absent Power Off**

When you set the timer "On", your television will eventually be turned off, if you do not operate any controls during the 3 hours after the TV is turned on by timer.

This function is available in only the timer "On" mode and will prevent a leakage accident or overheating, caused by your TV left on for a long time due to the timer "On" (when you are away on holiday, for example).

Setting the Sleep Timer

The sleep timer automatically shuts off the TV after a preset time (from 30 to 180 minutes).

1

Press the **MENU** button to display the menu.

Press the ▲ or ▼ button to select "Setup", then press the **ENTER** button.

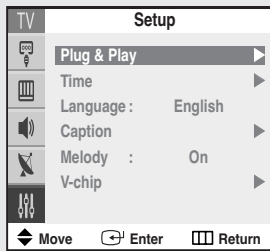

2

Press the ▲ or ▼ button to select "Time", then press the **ENTER** button.

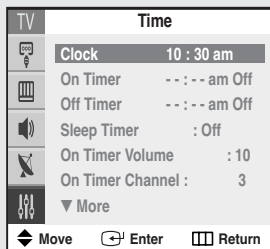

3

Press the ▲ or ▼ button to select "Sleep Timer".

Press the ◀ or ▶ button repeatedly until the appropriate time interval appears (any of the preset values from "Off" to "180"). Press the EXIT button to exit the menu.

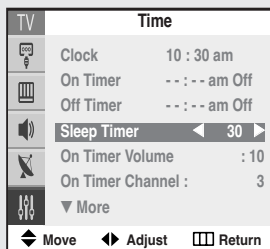

Alternate method:

Simply press the **SLEEP** button repeatedly until the appropriate time interval appears (any of the preset values from "Off" to "180").



◀ After about 5 seconds, the sleep display will disappear from the screen, and the time interval will be set.

Setting the Preferred Volume Level and Channel

The preferred volume and channel can be set for when the timer automatically turns on the TV.

1

Press the **MENU** button to display the menu.

Press the **▲** or **▼** button to select "Setup", then press the **ENTER** button.

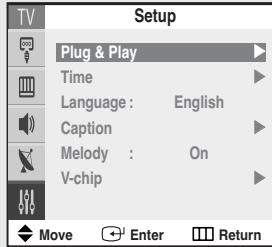

2

Press the **▲** or **▼** button to select "Time", then press the **ENTER** button.

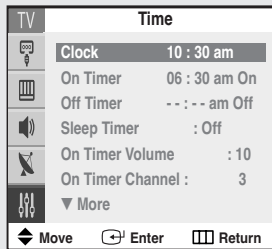

3

Press the **▲** or **▼** button to select "On Timer Volume".

Press the **◀** or **▶** button to adjust volume level.

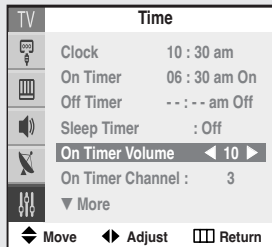

4

Press the **▲** or **▼** button to select "On Timer Channel".

Press the **◀** or **▶** button to select channel

Press the **EXIT** button to exit the menu.

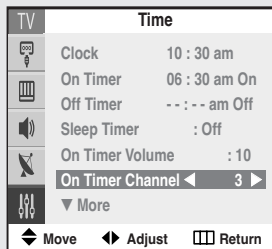

Viewing Closed Captions

Your TV decodes and displays the closed captions that are broadcast with certain TV shows. These captions are usually subtitles for the hearing impaired or foreign-language translations. All VCRs record the closed caption signal from television programs, so home-recorded video tapes also provide closed captions. Most pre-recorded commercial video tapes provide closed captions as well. Check for the closed caption symbol in your television schedule and on the tape's packaging: .

1

Press the **MENU** button to display the menu.

Press the **▲** or **▼** button to select the "Setup", then press the **ENTER** button.

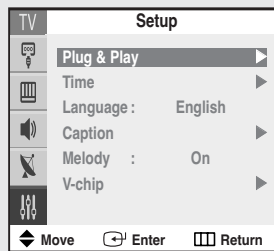

2

Press the **▲** or **▼** button to select the "Caption", then press the **ENTER** button.

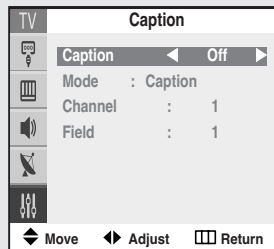

3

Press the **◀** or **▶** button to turn closed captioning "On" or "Off".

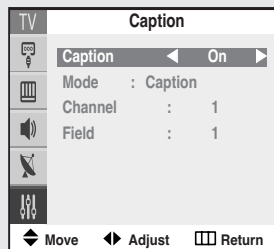

4

Press the **▲** or **▼** button to select "Mode", press the **◀** or **▶** button to select "Caption" or "Text".

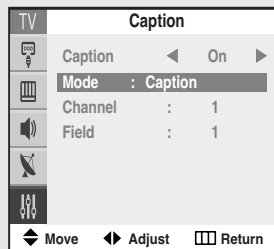

5

Depending on the particular broadcast, it might be necessary to make changes to "Channels" and "Field": Use the **▲**, **▼**, **◀** and **▶** buttons to make the changes. (Follow the same procedure as in steps 3-4 above.)

Press the EXIT button to exit the menu.

◀ Misspellings and unusual characters sometimes occur during closed caption transmissions, especially those of live events. There may be a small delay before captions appear when you change channels. These are not malfunctions of the TV.

◀ In "Caption" mode, captions appear at the bottom of the screen, and they usually cover only a small portion of the picture.

In "Text" mode, information unrelated to the program, such as news or weather, is displayed. Text often covers a large portion of the screen.

◀ Different channels and fields display different information: Field 2 carries additional information that supplements the information in Field 1. (For example, Channel 1 may have subtitles in English, while Channel 2 has subtitles in Spanish.)

Setting The On/Off Melody

You can hear clear a melody sound when the TV is powered On or Off.

1

Press the **MENU** button to display the menu.

Press the **▲** or **▼** button to select the "Setup", then press the **ENTER** button.

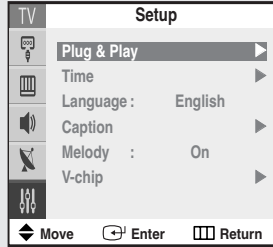

2

Press the **▲** or **▼** button to select "Melody".

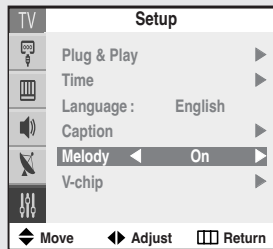

3

Press the **◀** or **▶** button to select "On", then press the **ENTER** button.

Press the **EXIT** button to exit the menu.

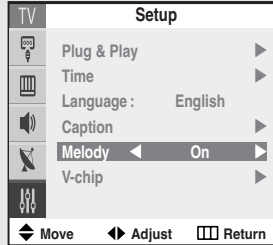

Using the V-Chip

The V-Chip feature automatically locks out programming that is deemed inappropriate for children. The user must first enter a PIN (personal ID number) before any of the V-Chip restrictions can be set up or changed.

Note : When the V-chip feature is active, channel-auto program features do not function.

Setting Up Your Personal ID Number (PIN)

1

Press the **MENU** button to display the menu.

Press the **▲** or **▼** button to select the "Setup", then press the **ENTER** button.

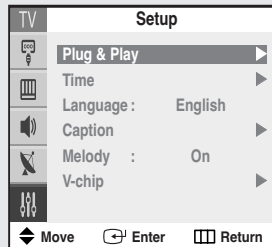

2

Press the **▲** or **▼** button to select the "V-Chip", then press the **ENTER** button.

The "Enter Pin" screen will appear. Enter your 4-digit PIN number,

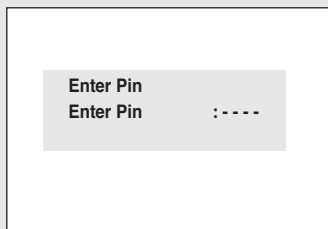

Note: The default PIN number for a new TV set is "0-0-0-0".

3

After entering a valid PIN number, the "V-Chip" screen will appear. Press the **▲** or **▼** button and select "Change Pin."

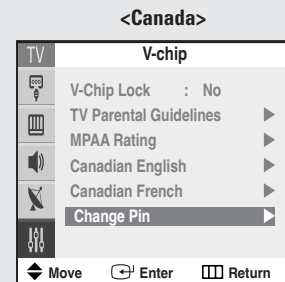
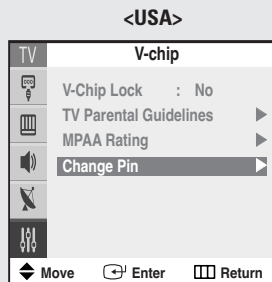

4

While the "Change Pin" field is selected, press the **ENTER** button.

The Change pin screen will appear. Choose any 4-digits for your PIN and enter them.

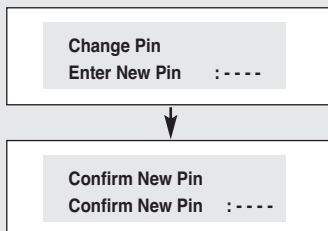

As soon as the 4 digits are entered, the "Confirm New Pin" screen appears. Re-enter the same 4 digits. When the Confirm screen disappears, your PIN has been memorized. Press the EXIT button to exit the menu.

◀ Note: If you forget the PIN, press the remote-control keys in the following sequence, which resets the pin to 0-0-0-0:

POWER OFF → MUTE → 8 → 2 → 4 → POWER ON.

How to Enable/Disable the V-Chip

1

Press the **MENU** button to display the menu.

Press the **▲** or **▼** button to select the "Setup", then press the **ENTER** button.

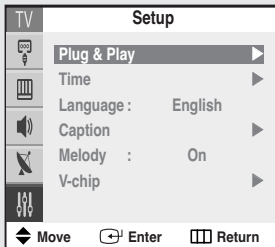

2

Press the **▲** or **▼** button to select the "V-Chip", then press the **ENTER** button.

The "Enter Pin" screen will appear. Enter your 4-digit PIN number.

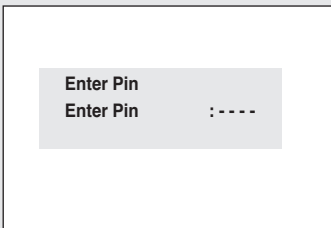

3

To enable the V-Chip feature, press the **▶** button so that the "V-Chip Lock" field is Yes. (Pressing the **▶** button will alternate between Yes and No.)

Press the EXIT button to exit the menu.

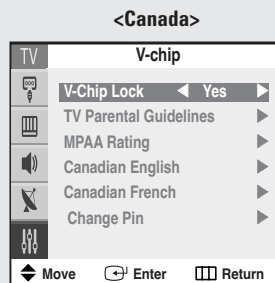
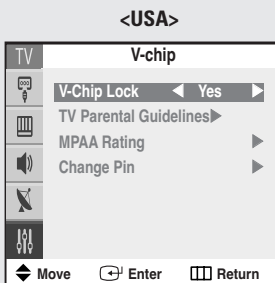

How to Set up Restrictions Using the "TV Parental Guidelines"

First, set up a personal identification number (PIN), and enable the V-Chip. (See previous section.) Parental restrictions can be set up using either of two methods: The TV Parental Guidelines or the MPA rating.

1

Press the **MENU** button to display the menu.

Press the **▲** or **▼** button to select the "Setup", then press the **ENTER** button.

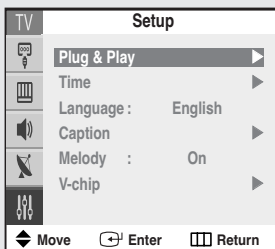

2

Press the **▲** or **▼** button to select the "V-Chip", then press the **ENTER** button.

The "Enter Pin" screen will appear. Enter your 4-digit PIN number.

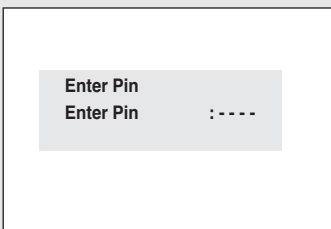

continued...

SPECIAL FEATURES

3

Press the ▲ or ▼ button to select the “TV Parental Guidelines”, then press the **ENTER** button.

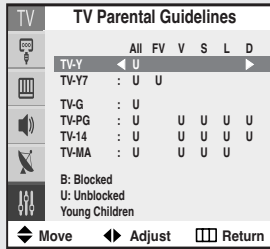

4

The “TV Parental Guidelines” screen will appear. Press the ▲, ▼ buttons to select one of the six age-based categories:

TV-Y	Young children
TV-Y7	Children 7 and over

TV-G	General guidance
TV-PG	Parent Guidance
TV-14	Viewers 14 and over
TV-MA	Mature Audience

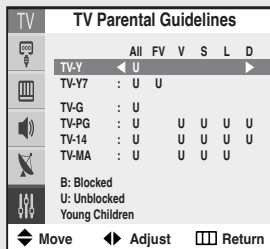

◀ Note: These categories consist of two separate groups: TV-Y and TV-Y7 (young children through age 7), and TV-G through TV-MA (everybody else).

The restrictions for these two groups work independently: If a household includes very young children as well as young adults, the TV Parental Guidelines must be set up separately for each age group. (See next step.)

5

At this point, one of the TV-Ratings is selected.

Press the ► button: Depending on your existing setup, a letter “U” or “B” will be selected. (U= Unblocked, B= Blocked)

While the “U” or “B” is red, press the ▲ or ▼ button to block or unblock the category.

Press the ► button once to save the TV Parental Guidelines. A TV-Rating will be selected, and no letters will be selected. To exit this screen, press the **MENU** button again. To select a different TV-Rating, press the ▲ or ▼ button and then repeat the process.

Note 1: The TV-Y7, TV-PG, TV-14 and TV-MA have additional options. See the next step to change any of the following sub-ratings:

FV: Fantasy violence
D: Dialog
L: Adult language
S: Sexual situation
V: Violence

Note 2: The V-Chip will automatically block certain categories that are “more restrictive”. For example, if you block “TV-Y” category, then TV-Y7 will automatically be blocked. Similarly, if you block the TV-G category, then all the categories in the “young adult” group will be blocked (TV-G, TV-PG, TV-14 and TV-MA). The sub-ratings (D, L, S, V) work together similarly. (See next section.)

6

How to set the FV, D, L, S and V sub-ratings:

First, select one of these TV-Ratings: TV-Y7, TV-PG, TV-14 or TV-MA (See Step 4, on previous page).

Next, while the TV-Rating is selected, repeatedly press the ► button. This will cycle through the available sub-ratings (FV, L, S, D or V).

A letter (“U” or “B”) will be displayed for each sub-rating. While the “U” or “B” is selected, press the ▲ or ▼ button to change the sub-rating.

Press the ► button once to save the TV Parental Guidelines. A TV-Rating will be selected, and no letters will be selected. To exit this screen, press the **MENU** button again. To select a different TV-Rating, press the ▲ or ▼ button and then repeat the process.

Note: The V-chip will automatically block certain categories that are “More restrictive”. For example, if you block “L” sub-rating in TV-PG, then the “L” sub-ratings in TV-14 and TV-MA will automatically be blocked.

7

Press the **EXIT** button to clear all the screens. (Or proceed to the next section, and set up additional restrictions based on the MPAA codes).

How to Set up Restrictions using the MPAA Ratings: G, PG, PG-13, R, NC-17, X, NR

The MPAA rating system uses the Motion Picture Association of America (MPAA) system, and its main application is for movies. (Eventually, movie videocassettes will be encoded with MPAA ratings.) When the V-Chip lock is on, the TV will automatically block any programs that are coded with objectionable ratings (either MPAA or TV-Ratings).

1

Press the **MENU** button to display the menu.

Press the ▲ or ▼ button to select the “Setup”, then press the **ENTER** button.

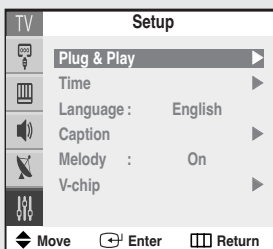

2

Press the ▲ or ▼ button to select the “V-Chip”, then press the **ENTER** button.

The “Enter Pin” screen will appear. Enter your 4-digit PIN number.

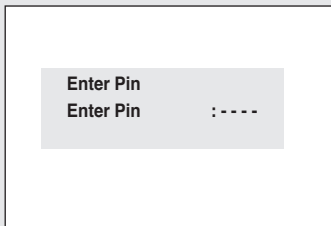

continued...

SPECIAL FEATURES

3

Press the ▲ or ▼ button to select the "MPAA Rating", then press the **ENTER** button.

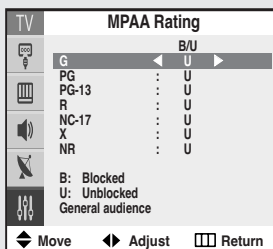

4

The "MPAA Rating" screen will appear.

Repeatedly press the ▲ or ▼ button to select a particular MPAA category.

Pressing the ▲ or ▼ button will cycle through the MPAA categories:

G	General audience.
PG	Parental guidance suggested.
PG-13	Parents strongly cautioned.
R	Restricted. Children under 17 requires.
NC-17	No children under age 17.
X	Adults only.
NR	Not rated.

While a particular category is selected, press ► to activate it. A letter ("U" or "B") will be selected. Press the ▲ or ▼ button to select "U" or "B".

Press the **EXIT** button to save the settings and to clear all screens.

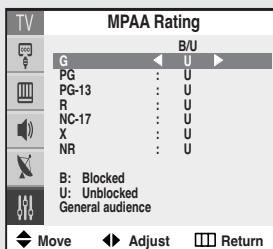

◀ Note: The V-Chip will automatically block any category that is "more restrictive." For example, if you block the "PG-13" category, then "R," "NC-17," and "X" will automatically be blocked also.

How to Set up Restrictions Using the Canadian English

1

Press the **MENU** button to display the menu.

Press the ▲ or ▼ button to select the "Setup", then press the **ENTER** button.

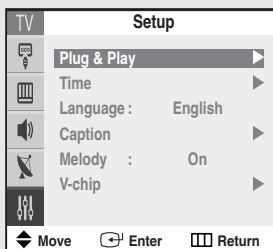

2

Press the ▲ or ▼ button to select the "V-Chip", then press the **ENTER** button.

The "Enter Pin" screen will appear. Enter your 4-digit PIN number.

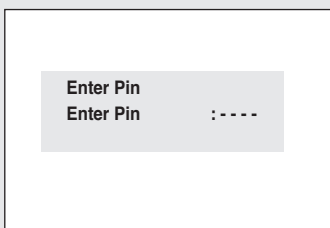

SPECIAL FEATURES

3

Press the ▲ or ▼ button to select the “Canadian English”, then press the **ENTER** button. The “Canadian English” screen will appear.

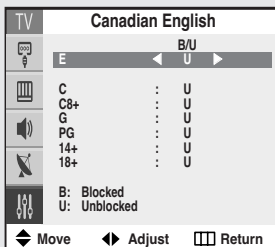

4

Repeatedly press the ▲ or ▼ button to select a particular Canadian English category. Pressing the ▲ or ▼ button will cycle through the Canadian English categories:

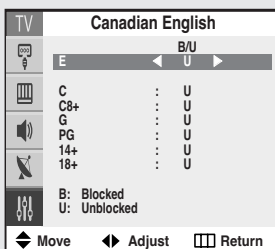

E	Exempt programming includes...news, sports, documentaries and other information programming, talk shows, music videos, and variety programming.
C	Programming intended for children under age 8.
C8+	Programming generally considered acceptable for children 8 years and over to watch on their own.
G	General programming, suitable for all audiences.
PG	Parental Guidance.

14+	Programming contains themes or content which may not be suitable for viewers under the age of 14.
18+	Adult programming.

While a particular category is selected, press the ► button to activate it. A letter (“U” or “B”) will be selected. Press the ▲ or ▼ button to select “U” or “B”.

Press the **EXIT** button to save the settings and to clear all screens.

How to Set up Restrictions Using the Canadian French

1

Press the **MENU** button to display the menu. Press the ▲ or ▼ button to select the “Setup”, then press the **ENTER** button.

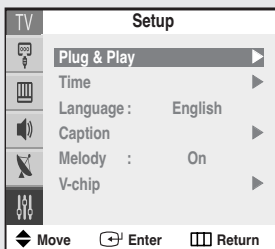

2

Press the ▲ or ▼ button to select the “V-Chip”, then press the **ENTER** button.

The “Enter Pin” screen will appear. Enter your 4-digit PIN number.

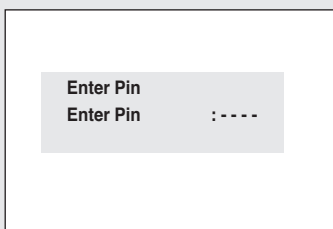

continued...

SPECIAL FEATURES

3

Press the ▲ or ▼ button to select the “Canadian French”, then press the **ENTER** button.

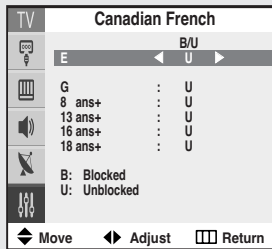

4

The “Canadian French” screen will appear.

Repeatedly press the ▲ or ▼ button to select a particular Canadian French category.

Pressing the ▲ or ▼ button will cycle through the Canadian French categories:

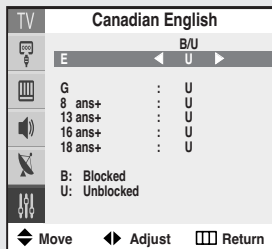

E Exempt programming includes...news, sports, documentaries and other information programming, talk shows, music videos, and variety programming.

G General.

8 ans+ 8+ General-Not recommended for young children.

13 ans+ Programming may not be suitable for children under the age of 13.

16 ans+ Programming is not suitable for children under the age of 16.

18 ans+ Programming restricted to adults.

While a particular category is selected, press the ► button to activate it. A letter (“U” or “B”) will be selected. Press the ▲ or ▼ button to select “U” or “B”.

Press the **EXIT** button to save the settings and to clear all screens.

How to Reset the TV after the V-Chip Blocks (“Emergency Escape”)

If the TV is tuned to a restricted channel, the V-Chip will block it. The screen will go blank and the following message will appear: “Excessive rating.”

To resume normal viewing, tune to a different channel using the number buttons. Under certain conditions (depending on the rating of the local TV programs) the V-Chip might lock out all the channels. In this case, use the V-Chip function for an “emergency escape”:

Press the **MENU** button to display the menu. Press the ▲ or ▼ button to select the “Setup” menu and press the **ENTER** button.

Press the ▲ or ▼ button to select the “V-Chip” menu and press the **ENTER** button. Enter your PIN number, and press the ► button to temporarily disable the V-Chip Lock.

Press the **EXIT** button to exit the menu.

Customizing Your Remote Control

Your TV comes equipped with a universal remote control. In addition to controlling the TV, the universal remote control can also operate a Set-Top Box, VCR, Cable box and DVD (even if your VCR, Cable box and DVD are made by manufacturers other than Samsung).

- The remote control might not be compatible with all VCRs, DVD players and Cable boxes.

Setting Up Your Remote Control to Operate Your VCR (Cable box or DVD player)

1

Turn off your VCR (Cable box or DVD player).

2

Press the **MODE** button and make sure that the **VCR (CABLE or DVD)** LED is illuminated.

◀ The remote control has five modes: TV, STB, VCR, CABLE and DVD.

3

On your Samsung remote control, press the **SET** button.

4

Enter 3 digits of the VCR (Cable box or DVD player) code listed on next page for your brand of VCR (Cable box or DVD player).

◀ Make sure you enter 3 digits of the code, even if the first digit is a "0". (If more than one code listed, try the first one.)

5

Press the **POWER** button on the remote control. Your VCR (Cable box or DVD player) should turn on. If your VCR (Cable box or DVD player) turns on, your remote control is now set correctly.

◀ If your VCR (Cable box or DVD player) does not turn on, repeat steps 2, 3, and 4, but try one of the other codes listed for the brand of your particular VCR (Cable box or DVD player).

6

Once your remote control is set up, press the **MODE** button any time you want to use the remote to operate your VCR (Cable box or DVD player).

- When your remote is in the TV mode, the VCR (or DVD player) control buttons (**REW**, **STOP**, **PLAY/PAUSE** and **FF**) will still operate your VCR (or DVD player).
- When your remote control is in the VCR (**CABLE** or **DVD**) mode, the volume buttons still control your TV's volume.

SPECIAL FEATURES

Remote Control Codes

VCR Codes

000	Samsung	018	Candle, Citizen, Emerson, LG(Goldstar), Radio Shack, Realistic, Sears, Toshiko, Teknika, Totevision	036	Electrohome, Emerson, Radio Shack, Realistic, Sharp	059	Pioneer
001	LG(Goldstar)			037	RCA	060	JC Penny
002				038	Magnavox, Marantz, Philco, Philips, Sylvania	061	Candle, Citizen, Portland
003		019	Broksonic, Emerson	039	JC Penny, JCL, Kenwood, Marantz, NEC, Tatung, Teac	062	Canon, Curtis Mathes, General Electric, JC Penny, Magnavox, Panasonic, Philco, Radio Shack, Realistic, Sylvania
004	Daewoo	021	Craig, Fisher, Radio Shack, Realistic, Sanyo, Sears	040	Logik, Multitech, Shintom	063	RCA
005				041	General Electric, Multitech, Samsung	064	Shintom
006				042	Pioneer	065	Magnavox, Philco, Sylvania
007	Daewoo, LG(Goldstar)	022	Audio Dynamics, Candle, Citizen, Daewoo, Emerson, Samsung, Scott, Toshiba	043	Emerson	066	Emerson
008	Daewoo			044	Hitachi, JC Penny, Pentax, RCA, Sears	067	Fisher
009	Curtis Mathes, Dimensia, General Electric, PROSCAN, RCA	023	Colortyme, Curtis Mathes, DB, LG(Goldstar), Harman Kardon, JC Penny, JCL, Kenwood, Marantz, NEC	045	Hitachi	069	LG(Goldstar)
011	Bell & Howell, Fisher, JC Penny, JCL, Kenwood, Marantz, NEC, Quartz, Radio Shack, Realistic, Sanyo, Sears, Tandy	024	Aiwa, Curtis Mathes, Dynatech, Emerson, Funai, Hitachi, Lloyd, LXI, MTC, Multitech, Radio Shack, Realistic, Signature, Sylvania, Symphonic, Tandy, Teac, Teknika	046	RCA	070	Marantz, NEC
014	Hitachi, JC Penny, Pentax, Pioneer, RCA, Sears, Toshiba			047	Sony	071	Emerson
015	Admiral, Optimus, Radio Shack, Realistic, Sharp	025	Audio Dynamics, DB, JC Penny, JCL, Kenwood, Marantz, NEC, Pioneer, Sansui	048	Sharp	076	Curtis Mathes, Emerson, TMK
016	Candle, Citizen, Craig, Curtis Mathes, General Electric, Go Video, JC Penny, MTC, Multitech, RCA, Samsung, Totevision	026	Akai, Shintom, Sony	050	Emerson, Scott	077	Emerson, Scott
017	Canon, Curtis Mathes, Emerson, General Electric, Instant Replay, JC Penny, JCL, Magnavox, Marantz, Panasonic, Philco, Philips, Quasar, Radio Shack, Realistic, RCA, Sylvania, Technics, Teknika	027	Fisher, Sears	051	Emerson, Samsung	078	RCA, Teac
		028	Fisher, Radio Shack, Realistic, Sears, Toshiba	052	Fisher, Radio Shack, Realistic, Sears	079	Emerson
		029	Emerson	053	Portland, Quasar	082	KLH
		030	Teknika	054	Candle, Citizen, Daewoo, Totevision, Sharp	084	Panasonic
		031	Akai, Samsung	055	Candle, Citizen, Curtis Mathes, LG(Goldstar), JCL, Kenwood, Marantz, NEC, Pentax Research+	085	Daewoo
		032	Akai, Emerson	056	Emerson	086	Panasonic
		033	Shintom, Sony	057	Fisher, Sears, Toshiba	088	Admiral
				058	Emerson, Scott, Toshiba		

Cable Box Codes

000	Samsung	020	Eastern International, Hamlin, Regal	038	GI, Jerrold	057	Tocom
001	Nawoo			039	Unika	058	
002	TaePyungYang	021	Hamlin, Regal	040	Magnavox, Philips, Unika, Viewstar	059	Universal
003	DeaRyung	022	Zenith	041	Magnavox, Philips, Regency, Viewstar	060	
004	DongKuk	023	GI, Jerrold	042	Hamlin	063	Tocom
005	DaeHan	024	Oak, Osk Sigma	043	GI, Jerrold	065	Zenith
006	LG(Goldstar)	025	Tocom	044	Hitachi, Macom	066	Stargate 2000
007	Saewoo	026	Pioneer	045	Hitachi, Macom	067	Sylvania, Texscan
008	RCA	027	Magnavox, Philips, Viewstar	046	Oak	069	Panasonic, Zenith
010	Regency	028	Pioneer	047	Panasonic	070	Jerrold
011	Hamlin, Panasonic, Regal, Samsung	029	Magnavox, Philips, Tocom, Viewstar	048	Magnavox, Philips, Viewstar	071	Samsung
012	GI, Hamlin, Jerrold	030	Samsung	049	Magnavox, Philips, Unika, Viewstar	072	Jerrold
013	GI, Jerrold	031		050	Zenith	074	RCA
015	Anvision, Cable Star, Eagle, Magnavox, Philips, Randtek, Viewstar	032	GI, Jerrold	051	Hitachi, Macom	075	
016		033		052	Pioneer, Samsung, Warner Amex	076	GI
017	NSC	034	Magnavox, Philips, Viewstar	054	General Instrument, Hitachi, Jerrold, Signature, Starcom	077	
019	Sylvania, Texscan	035	RCA, Panasonic, Sprucer	056	Hamlin		
		036	Magnavox, Philips, Viewstar				
		037					

DVD Codes

000	Samsung	003	JVC	006	Panasonic	009	Curtis Mathes
001	LG(Goldstar)	004	Sony	007	Philips		
002	Toshiba	005	Sharp	008	PROSCAN, RCA		

Chapter Five

TROUBLESHOOTING

If the TV seems to have a problem, first try this list of possible problems and solutions. If none of these troubleshooting tips apply, then call your nearest service center.

Identifying Problems

Problem	Possible Solution
Poor picture	Try another channel. Adjust the antenna. Check all wire connections.
Poor sound quality.	Try another channel. Adjust the antenna.
No picture or sound.	Try another channel. Press the TV/VIDEO button. Make sure the TV is plugged in. Check the antenna connections.
No color, wrong colors or tints.	Make sure the program is broadcast in color. Adjust the picture settings. If the set is moved or turned in a different direction, the power should be OFF for at least 30 minutes.
Picture rolls vertically.	Adjust the antenna. Check all wire connections.
The TV operates erratically	Unplug the TV for 30 seconds, then try operating it again.
Your remote control does not operate your TV.	Press the "MODE" button to put your remote control in the "TV" mode.
The TV won't turn on.	Make sure the wall outlet is working.

Cleaning and Maintaining Your TV

With proper care, your TV unit will give you many years of service. Please follow these guidelines to get the maximum performance from your TV.

Placement

- Do not place the TV near extremely hot, cold, humid or dusty places.
- Do not place the TV near appliances with electric motors that create magnetic fields, such as vacuum cleaners.
- Keep the ventilation openings clear; do not place the TV on a soft surface, such as cloth or paper.
- Place the TV in a vertical position only.

Liquids

- Do not handle liquids near or on the TV. Liquids that spill into it can cause serious damage.

Cabinet

- Never open the cabinet or touch the parts inside.
- Wipe your TV with a clean, dry cloth. Never use water, cleaning fluids, wax, or chemicals.
- Do not put heavy objects on top of the cabinet.

Temperature

- If your TV is suddenly moved from a cold to a warm place, unplug the power cord, and allow at least two hours for moisture that may have formed inside the unit to dry completely.

Using Your TV in Another Country

If you plan to take your TV with you to a foreign country, please be aware of the different television systems that are in use around the world. A TV designed for one system may not work properly with another system due to differences in the TV channel frequencies.

Specifications

Model	TX-P2665W TX-P3066W TX-P2664W TX-P3064W	TX-P2766 TX-P3266 TX-P2764 TX-P3264
Voltage	AC120 V	AC120 V
Frequency of Operation	60 Hz	60 Hz
Dimensions (mm/inches)	800 X 553 X 505 / 31.50 X 21.77 X 19.88 880 X 600 X 555 / 34.65 X 23.62 X 21.85 810 X 515 X 535 / 31.89 X 20.28 X 21.06 898 X 559 X 587 / 35.35 X 22.01 X 23.11	742 X 561 X 581 / 29.21 X 22.08 X 22.87 880 X 585 X 690 / 34.65 X 23.03 X 27.17 762 X 519 X 600 / 30.00 X 20.43 X 23.62 911 X 579 X 703 / 35.87 X 22.80 X 27.68
Weight (Kg/lbs)	40.4 / 89.07 56.0 / 123.46 40.2 / 88.63 56.0 / 123.46	45.5 / 100.31 68.0 / 149.92 47.5 / 104.72 67 / 147.71

MEMO



1-800-SAMSUNG (1-800-726-7864)

U.S.A

**Samsung Electronics America
Service Division**

400 Valley Road, Suite 201
Mount Arlington, NJ 07856
www.samsungusa.com

CANADA

**Samsung Electronics Canada Inc.
Samsung Customer Care**

7037 Financial Drive
Mississauga, Ontario
L5N 6R3
www.samsung.ca