

SAMSUNG

**CL-29Z30
CL-29Z40**

COLOR TELEVISION

**Owner's
Instructions**

Register your product at www.samsung.com/global/register

Important Warranty Information Regarding Television Format Viewing

Standard screen format televisions (4:3, the aspect ratio of the screen width to height) are primarily designed to view standard format full-motion video. The images displayed on them should primarily be in the standard 4:3 ratio format and constantly moving. Displaying stationary graphics and images on screen, such as the dark top and bottom letterbox bars (wide screen pictures), should be limited to no more than 15% of the total television viewing per week.

Wide screen format televisions (16:9, the aspect ratio of the screen width to height) are primarily designed to view wide screen format full-motion video. The images displayed on them should primarily be in the wide screen 16:9 ratio format, or expanded to fill the screen if your model offers this feature, and constantly moving. Displaying stationary graphics and images on screen, such as the dark side-bars on non-expanded standard format television video and programming, should be limited to no more than 15% of the total television viewing per week.

Additionally, viewing other stationary images and text such as stock market reports, video game displays, station logos, web sites or computer graphics and patterns, should be limited as described above for all televisions. ***Displaying any stationary images that exceed the above guidelines can cause uneven aging of picture tubes (CRTs) that leave subtle, but permanent burned-in ghost images in the television picture. To avoid this, vary the programming and images, and primarily display full screen moving images, not stationary patterns or dark bars.*** On television models that offer picture sizing features, use these controls to view the different formats as a full screen picture.

Be careful in the selection and duration of television formats used for viewing. Uneven CRT aging as a result of format selection and use, as well as other burned-in images, is not covered by your Samsung limited warranty.

Contents

GENERAL INFORMATION

■ List of Features	4
■ Accessories	4
■ Viewing the Control Panel.....	5
■ Viewing the Connection Panel.....	6
■ Remote Control.....	7
■ Installing Batteries in the Remote Control	8

CONNECTIONS

■ Connecting VHF and UHF Antennas.....	8
■ Connecting Cable TV	9
■ Connecting a VCR	10
■ Connecting an S-VHS VCR	10
■ Connecting a Second VCR to Record from the TV	11
■ Connecting a Camcorder	11
■ Connecting a DVD Player/Set-Top Box	12
■ Connecting an Amplifier/DVD Home Theater	12

OPERATION

■ Turning the TV On and Off.....	13
■ Plug & Play Feature	13
■ Changing Channels	14
■ Adjusting the Volume	15
■ Viewing the Display.....	15
■ Viewing the Menus.....	15
■ Memorizing the Channels	16
■ To Select the Source.....	17
■ To Edit the Input Source Name.....	17

PICTURE CONTROL

■ Using Automatic Picture Settings.....	18
■ Customizing the Picture	18
■ Adjusting the Color Tone.....	19
■ Changing the Screen Size	19
■ Digital Noise Reduction.....	20
■ DNLe Jr(Digital Natural Image engine Junior) (depending on the model)	20
■ Tilt (depending on the model)	20
■ Viewing Picture-in-Picture (depending on the model).....	21

SOUND CONTROL

■ Using Automatic Sound Settings	22
■ Customizing the Sound	23
■ Choosing a Multi-Channel Sound (MTS) track.....	23
■ Automatic Volume Control	24
■ Turbo Sound	24
■ Pseudo Stereo	24

CHANNEL CONTROL

■ Adding and Erasing Channels.....	25
■ Labeling Channels	25
■ LNA (Low Noise Amplifier) (depending on the model).....	26
■ Using the R.Surf Feature.....	26

TIME SETTING

■ Setting the Time.....	27
-------------------------	----

FUNCTION DESCRIPTION

■ Viewing Closed Captions(On-Screen Text Messages).....	29
■ Selecting a Menu Language.....	30
■ Setting the Blue Screen Mode.....	30
■ Setting the On/Off Melody	31
■ Viewing the Demonstration.....	31
■ Locking the Channel.....	32

APPENDIX

■ Identifying Problems	33
■ Specifications.....	33



General Information

List of Features

- ♦ Adjustable picture settings that can be stored in the TV's memory.
- ♦ Automatic timer to turn the TV on and off.
- ♦ A special sleep timer.
- ♦ Excellent Picture Quality
 - DNIe Jr technology provides life-like clear images. (depending on the model)

Accessories

Please make sure the following items are included with your TV.
If any items are missing, contact your dealer.



Remote Control
(AA59-00384A) (AA59-00385A) /
AAA Batteries



Owner's Instructions /
Safety Guide Manual



Warranty Cards / Registration Card
(Not available in all locations)

The following parts are sold separately and are available at most electronics stores.



S-VIDEO Cable



Antenna Cable

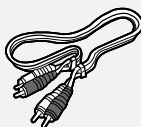

Audio Cable

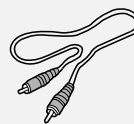

Video Cable



Component Cable

Viewing the Control Panel

Buttons on the Lower-Right Part of the Panel

The buttons on the lower-right panel control your TV's basic features, including the on-screen menu. To use the more advanced features, you must use the remote control.

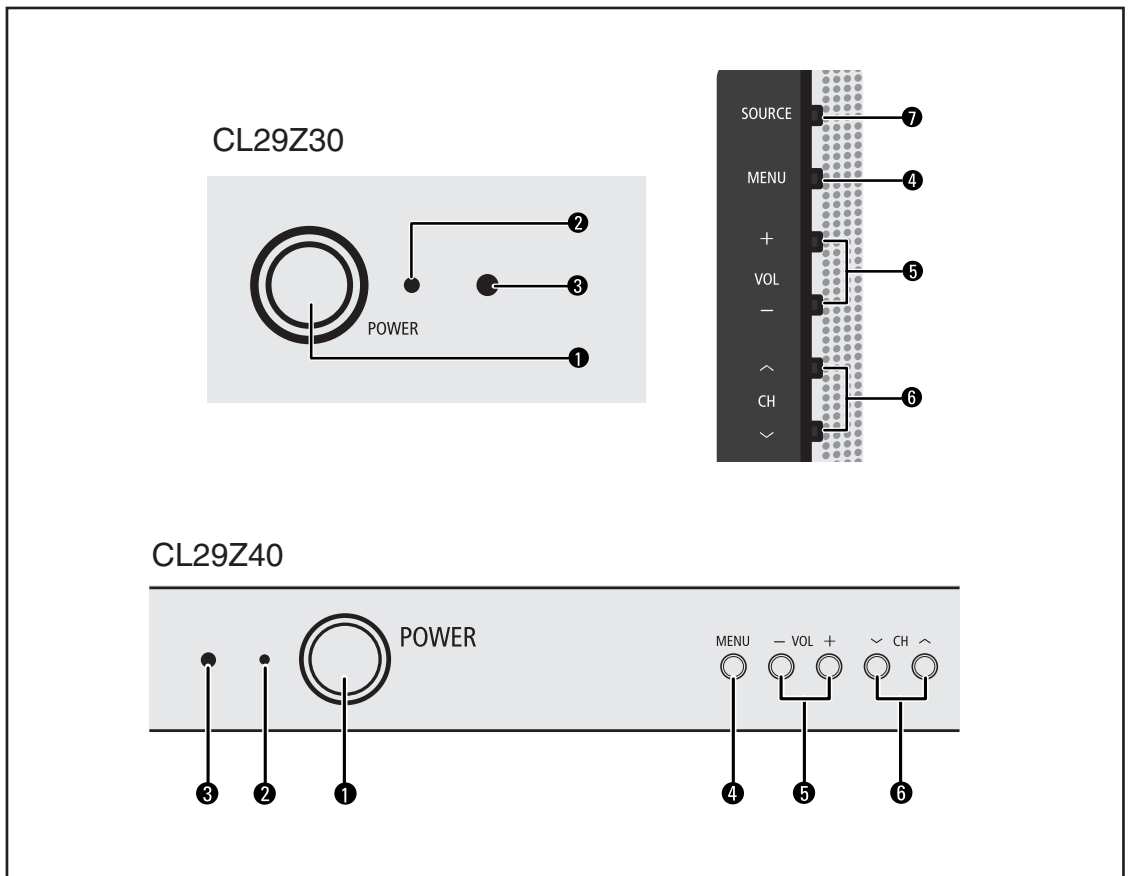

1 POWER

Press to turn the TV on and off.

2 Power Indicator

Blinks and turns off when the power is on and lights up in stand-by mode.

3 REMOTE CONTROL SENSOR

Aim the remote control towards this spot on the TV.

4 MENU

Press to see an on-screen menu of your TV's features.

5 + VOL -

Press to increase or decrease the volume.

In the on-screen menu, use the **+ VOL -** buttons as you use the **◀** and **▶** buttons or **ENTER** (**⏏**) button on the remote control.

6 ^ CH v

Press to change channels.

In the on-screen menu, use the **^ CH v** button as you would use the **▲** and **▼** button on the remote control.

7 SOURCE

Toggles between all the available input sources (TV, AV1, AV2, S-Video, Component).

Viewing the Connection Panel

Rear Panel Jacks

Use the rear panel jacks to connect A/V components that will be connected continuously, such as VCR or DVD players. For more information on connecting equipment, see pages 8-12.

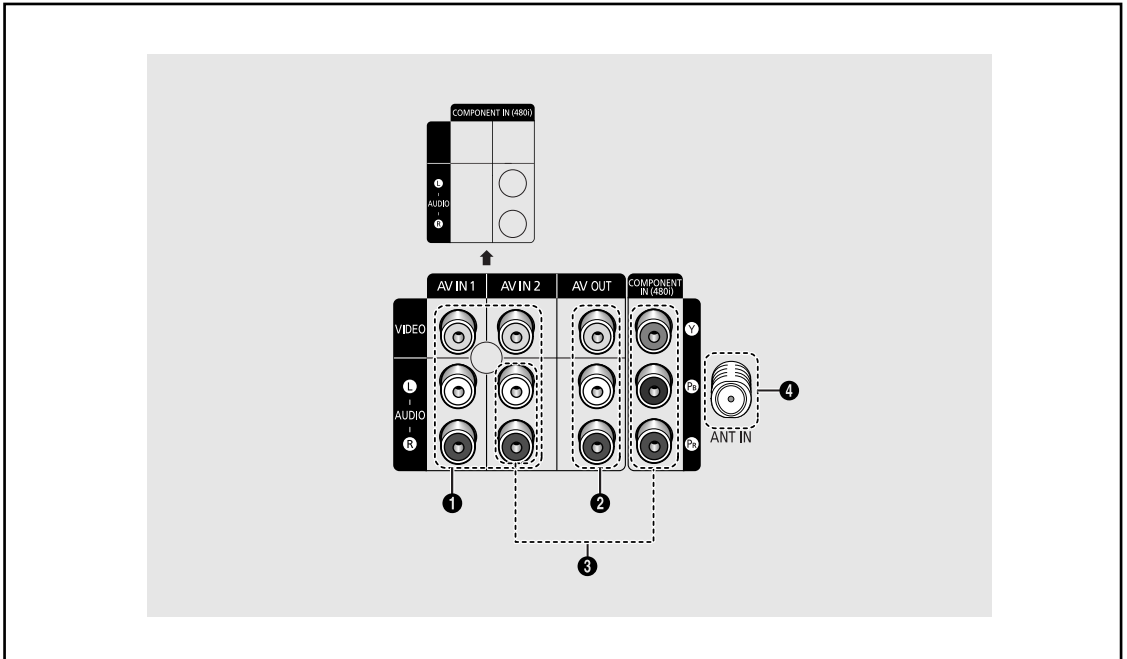

1 AV IN 1, 2

Connect to the video output jacks of VCRs, DVD players and similar devices.

2 AV OUT

Connect to the audio/video input jacks of a recording VCR.

3 COMPONENT IN (480i)

Connect to the Component audio and video outputs of a DVD or DTV set-top box. 480i video signal input is available.

4 ANT IN

Connect to an antenna(air) or cable TV system.

Side Panel Jacks

Use the left side panel jacks to connect a component that is used only occasionally, such as a camcorder or video game. (See page 11)

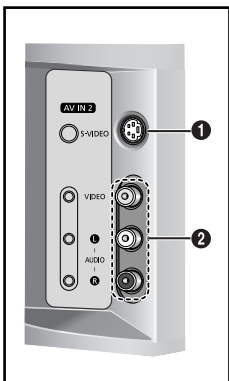

1 S-VIDEO

Video inputs for external devices with an S-Video output.

2 AV IN 2

Video and audio inputs for external devices.

Remote Control

You can use the remote control up to a distance of about 23 feet from the TV. When using the remote control, always point it directly at the TV. You can also use your remote control to operate your VCR, Cable box, DVD player, or Set-Top Box.

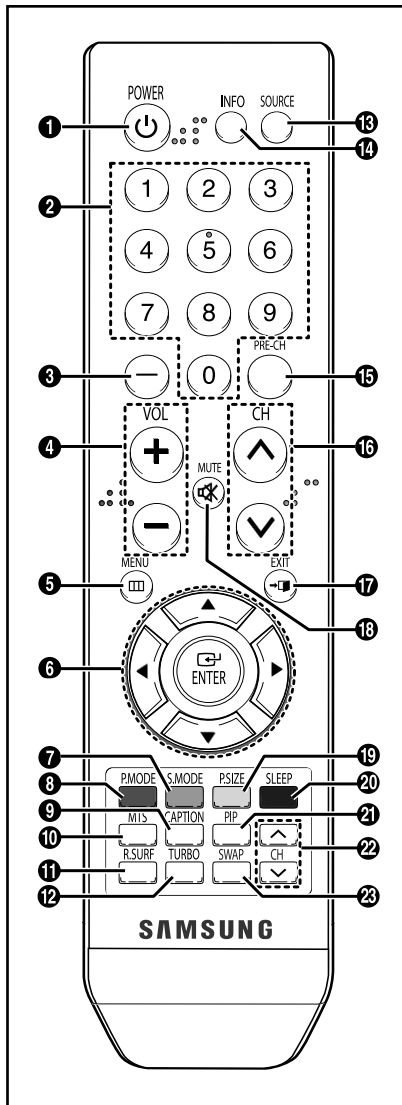

- 1 POWER**
Turns the TV on and off.
- 2 NUMERIC BUTTONS**
Press to change the channel.
- 3 -**
Use to select a channel over 100, For example, for channel 122, press "-", then "2", then "2".
- 4 + VOL -**
Press to increase or decrease the volume.
- 5 MENU**
Displays the main on-screen menu.
- 6 UP▲ / DOWN▼ / LEFT◀ / RIGHT▶ / ENTER**
Use to select on-screen menu items and change menu values.
- 7 S.MODE**
Press to select the sound mode.
- 8 P.MODE**
Press to select the picture mode.
- 9 CAPTION**
Controls the caption decoder.
- 10 MTS**
Press to choose stereo, mono or Separate Audio Program (SAP broadcast).
- 11 R.SURF**
Press to automatically return to a preferred channel after a user-preset time delay.
- 12 TURBO**
Press to select Turbo sound.
- 13 SOURCE**
Press to display all of the available video sources.
- 14 INFO**
Press to display information on the TV screen.
- 15 PRE-CH**
Tunes to the previous channel.
- 16 ^ CH v**
Press to change channels.
- 17 EXIT**
Press to exit the menu.
- 18 MUTE**
Press to temporarily cut off the sound.
- 19 P.SIZE**
Press to change the screen size.
- 20 SLEEP**
Press to select a preset time interval for automatic shut off.
- 21 PIP (depending on the model)**
Picture-in Picture ON/OFF.
- 22 CH (depending on the model)**
Displays the available channels in sequence. (These buttons change channels in the PIP window only.)
- 23 SWAP (depending on the model)**
Switches the main and sub (PIP) picture.

➤ This is a special remote control for the visually impaired, and has Braille points on the Power, Channel and Volume buttons.

Installing Batteries in the Remote Control

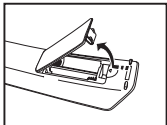

1. Lift the cover at the back of the remote control upward as shown in the figure.
2. Install two AAA size batteries.
 - Make sure to match the "+" and "-" ends of the batteries with the diagram inside the compartment.
3. Replace the cover.
 - Remove the batteries and store them in a cool, dry place if you won't be using the remote control for a long time. The remote control can be used up to about 23 feet from the TV. (Assuming typical TV usage, the batteries last for about one year.)

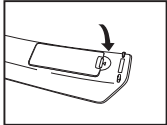
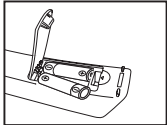

- **If the remote control doesn't work, check the following:**
1. Is the TV power on?
 2. Are the plus and minus ends of the batteries reversed?
 3. Are the batteries drained?
 4. Is there a power outage, or is the power cord unplugged?
 5. Is there a special fluorescent light or neon sign nearby?

Connections

Connecting VHF and UHF Antennas

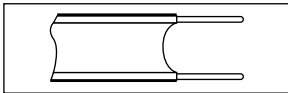

If your antenna has a set of leads that look like this, see "Antennas with 300 Ω Flat Twin Leads" below.

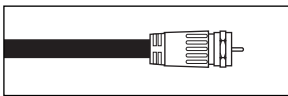

If your antenna has one lead that looks like this, see "Antennas with 75 Ω Round Leads". If you have two antennas, see "Separate VHF and UHF Antennas".

Antennas with 300 Ω Flat Twin Leads

If you are using an off-air antenna (such as a roof antenna or "rabbit ears") that has 300 Ω twin flat leads, follow the directions below.

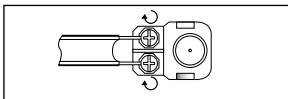

1. Place the wires from the twin leads under the screws on a 300-75 Ω adapter (not supplied). Use a screwdriver to tighten the screws.

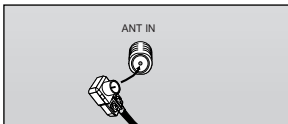

2. Plug the adaptor into the ANT IN terminal on the back of the TV.

Antennas with 75 Ω Round Leads

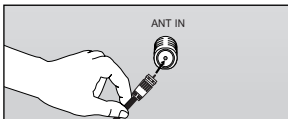

1. Plug the antenna lead into the ANT IN terminal on the back of the TV.

Separate VHF and UHF Antennas

If you have two separate antennas for your TV (one VHF and one UHF), you must combine the two antenna signals before connecting the antennas to the TV. This procedure requires an optional combiner-adaptor (available at most electronics shops).

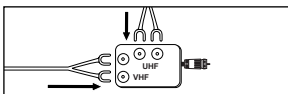

1. Connect both antenna leads to the combiner.

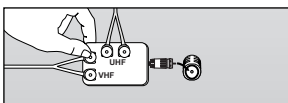

2. Plug the combiner into the ANT IN terminal on the bottom of the back panel.

Connecting Cable TV

To connect to a cable TV system, follow the instructions below.

Cable without a Cable Box

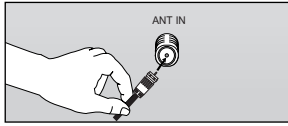

1. Plug the incoming cable into the ANT IN terminal on the back of the TV.
 - Because this TV is cable-ready, you do not need a cable box to view unscrambled cable channels.

Connecting to a Cable Box that Descrambles All Channels

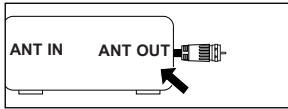

1. Find the cable that is connected to the ANT OUT terminal on your cable box.
 - This terminal might be labeled "ANT OUT", "VHF OUT" or simply, "OUT".

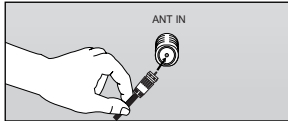

2. Connect the other end of this cable to the ANT IN terminal on the back of the TV.

Connecting to a Cable Box that Descrambles Some Channels

If your cable box descrambles only some channels (such as premium channels), follow the instructions below. You will need a two-way splitter, an RF (A/B) switch, and four lengths of Antenna Cable. (These items are available at most electronics stores.)

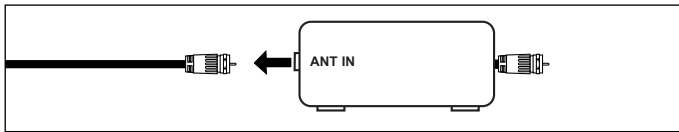

1. Find and disconnect the cable that is connected to the ANT IN terminal on your cable box.
 - This terminal might be labeled "ANT IN", "VHF IN" or simply, "IN".

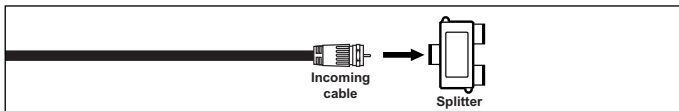

2. Connect this cable to a two-way splitter.

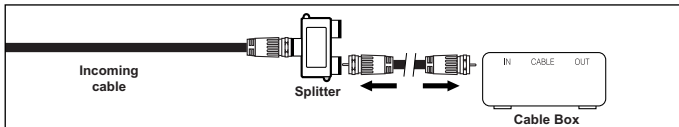

3. Connect an Antenna Cable between an OUTPUT terminal on the splitter and the IN terminal on the cable box.

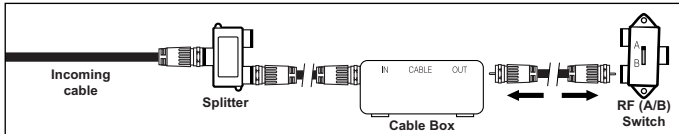

4. Connect an Antenna Cable between the ANT OUT terminal on the cable box and the B-IN terminal on the RF (A/B) switch.

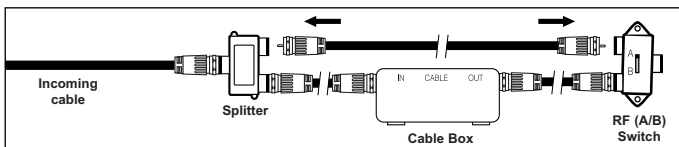

5. Connect another cable between the other OUTPUT terminal on the splitter and the A-IN terminal on the RF (A/B) switch.

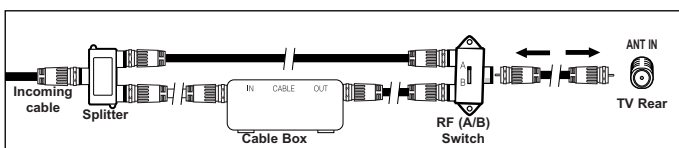

6. Connect the last Antenna Cable between the OUT terminal on the RF (A/B) switch and the ANT IN terminal on the rear of the TV.

After you have made this connection, set the A/B switch to the "A" position for normal viewing. Set the A/B switch to the "B" position to view scrambled channels. (When you set the A/B switch to "B", you will need to tune your TV to the cable box's output channel, which is usually channel 3 or 4.)

Connecting a VCR

These instructions assume that you have already connected your TV to an antenna or a cable TV system (according to the instructions on pages 8-9). Skip step 1 if you have not yet connected to an antenna or a cable system.

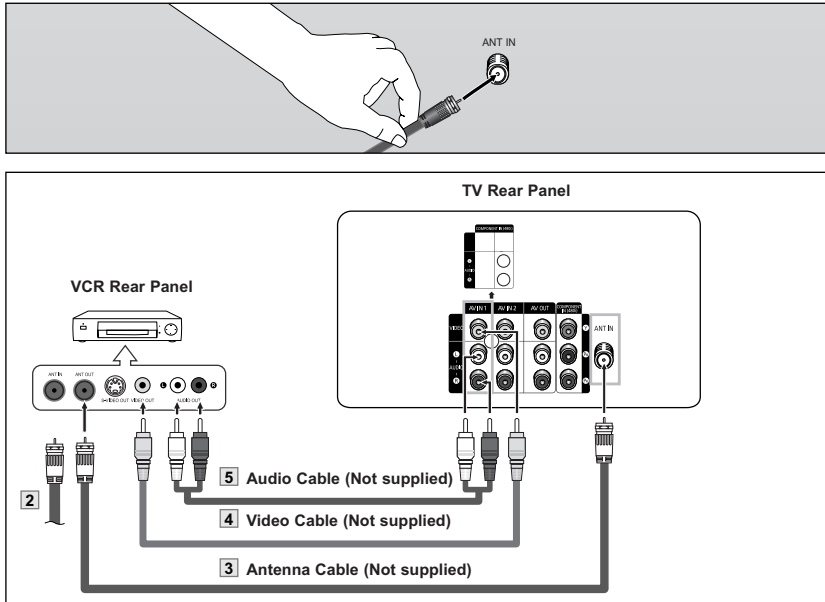

- Each external input source device has a different back panel configuration.
- When connecting an external device, match the color of the connection terminal to the cable.
- Also, you can connect to "AV IN 2" on the side panel of TV.

1. Unplug the cable or antenna from the back of the TV.
2. Connect the cable or antenna to the ANT IN terminal on the back of the VCR.
3. Connect an Antenna Cable between the ANT OUT terminal on the VCR and the ANT IN terminal on the TV.
4. Connect a Video Cable between the VIDEO OUT jack on the VCR and the AV IN 1 or AV IN 2 [VIDEO] jack on the TV.
5. Connect Audio Cables between the AUDIO OUT jacks on the VCR and the AV IN 1 or AV IN 2 [L-AUDIO-R] jacks on the TV.

- If you have a "mono" (non-stereo) VCR, use a Y-connector (not supplied) to hook up to the right and left audio input jacks of the TV. If your VCR is stereo, you must connect two cables.

Connecting an S-VHS VCR

Your Samsung TV can be connected to an S-Video signal from an S-VHS VCR. (This connection delivers a better picture as compared to a standard VHS VCR.)

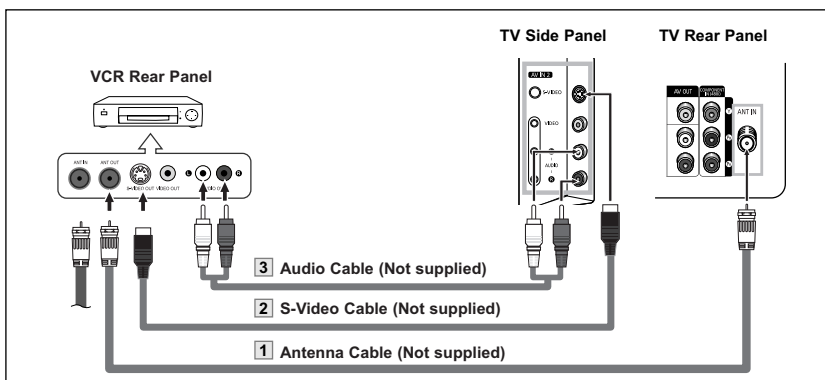

An S-Video cable is usually included with an S-VHS VCR. (If not, check your local electronics store.)

- Each external input source device has a different back panel configuration.
- When connecting an external device, match the color of the connection terminal to the cable.

1. To begin, follow steps 1-3 in the previous section to connect the antenna or cable to your VCR and your TV.
2. Connect an S-Video Cable between the S-VIDEO OUT jack on the VCR and the AV IN 2 [S-VIDEO] jack on the TV.
3. Connect Audio Cables between the AUDIO OUT jacks on the VCR and the AV IN 2 [L-AUDIO-R] jacks on the TV.

Connecting a Second VCR to Record from the TV

Your TV can send out signals of its picture and sound to be recorded by a second VCR. To do this, connect your second VCR as follows:

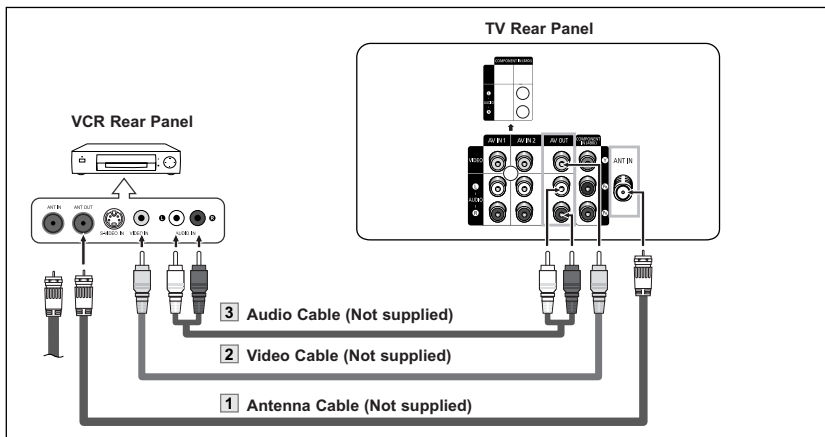

➤ When connecting an external device, match the color of the connection terminal to the cable.

1. To begin, follow steps 1–3 in the previous section to connect the antenna or cable to your VCR and your TV.
2. Connect a video cable between the AV OUT [VIDEO] jack on the TV and the VIDEO IN jack on the VCR. Refer to your VCR's instructions for more information about how to record using this kind of connection.
3. Connect a set of audio cables between the AV OUT [L-AUDIO-R] jacks on the TV and the AUDIO IN jacks on the VCR. (The VCR input jacks might be either on the front or on back of the VCR.)

Connecting a Camcorder

The side panel jacks on your TV make it easy to connect a camcorder to your TV. They allow you to view the camcorder tapes without using a VCR.

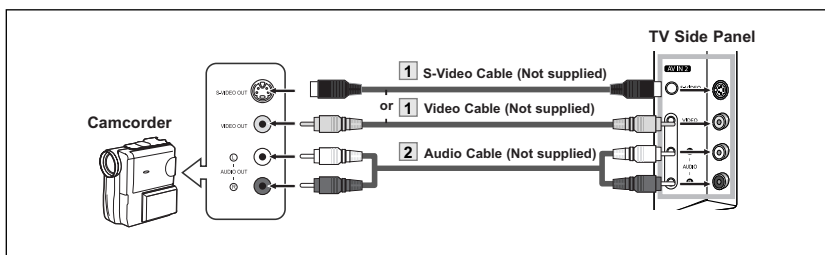

➤ Each external input source device has a different back panel configuration.
 ➤ When connecting an external device, match the color of the connection terminal to the cable.

1. Connect a Video Cable (or S-Video Cable) between the AV IN 2 [VIDEO] (or S-VIDEO) jack on the TV and the VIDEO (or S-VIDEO) jack on the camcorder.
2. Connect Audio Cables between the AV IN 2 [L-AUDIO-R] jacks on the TV and the AUDIO OUT jacks on the camcorder.

Connecting a DVD Player/Set-Top Box

The rear panel jacks on your TV make it easy to connect a DVD player/Set-Top Box to your TV.

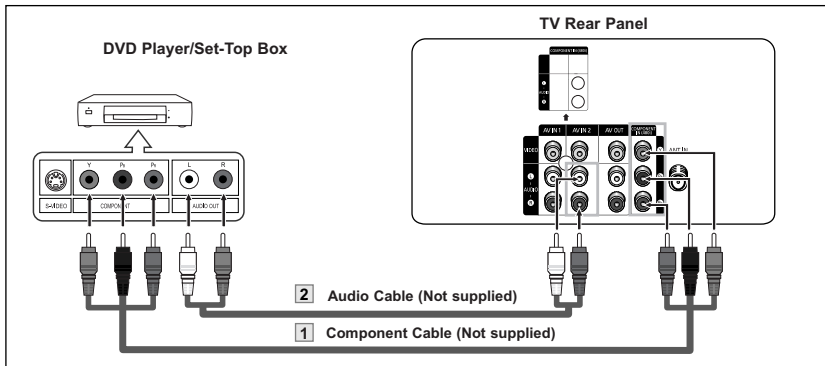

1. Connect a Component Cable between the COMPONENT IN (480i) [Y, P_B, P_R] jacks on the TV and the COMPONENT Y, P_B, P_R jacks on the DVD Player/Set-Top Box.
2. Connect Audio Cables between the AV IN 2 [L-AUDIO-R] jacks on the TV and the AUDIO OUT jacks on the DVD Player/Set-Top Box.

- Component video separates the video into Y (Luminance (brightness)), P_B (Blue) and P_R (Red) for enhanced video quality. Be sure to match the component video and audio connections. For example, if connecting the video cable to COMPONENT IN, connect the audio cable to AV IN 2 [L-Audio-R] also.
- Each external input source device has a different back panel configuration.
- When connecting an external device, match the color of the connection terminal to the cable.

Connecting an Amplifier/DVD Home Theater

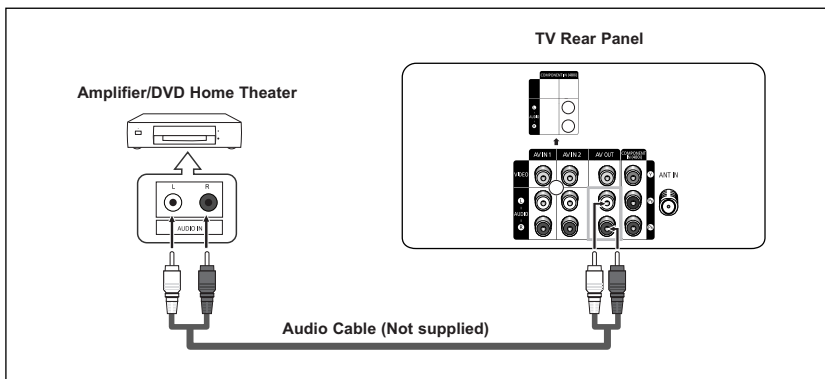

1. Connect Audio Cables between the AV OUT [L-AUDIO-R] on the TV and AUDIO IN on the Amplifier/DVD Home Theater.

When an audio amplifier is connected to the "AUDIO OUT [L-AUDIO-R]" terminals: Decrease the gain (volume) of the TV, and adjust the volume level with the Amplifier's volume control.

- Each external input source device has a different back panel configuration.
- When connecting an external device, match the color of the connection terminal to the cable.

Operation

Turning the TV On and Off

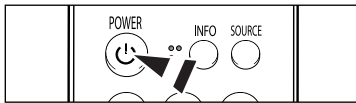

Press the **POWER** button on the remote control.
You can also use the **POWER** button on the TV.

Plug & Play Feature

When the TV is initially powered on, basic customer settings proceed automatically and subsequently:

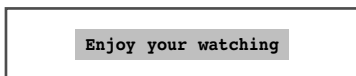
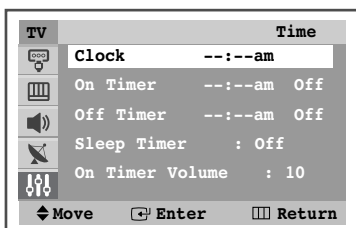
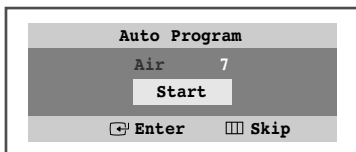
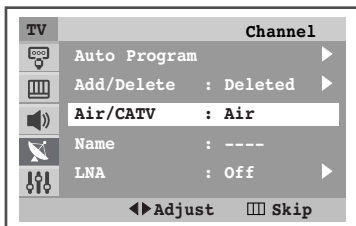
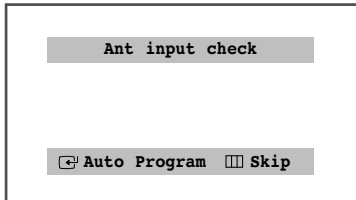
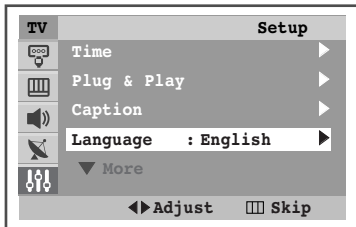
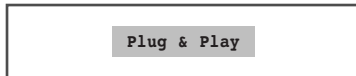

1. Press the **POWER** button on the remote control.
The message "Plug & Play" is displayed. It flickers for a little while and then Language menu is automatically displayed.
2. Press the ◀ or ▶ button to select the language, then press the **MENU** button.
The message "Ant input check" is displayed.
➤ If any language is not selected on the Language menu, the Language menu will disappear about 30 seconds later.
3. Make sure that the antenna is connected to the TV.
Press the **ENTER** button.
The "Channel" menu is displayed with "Air/CATV" is selected.
4. Press the ◀ or ▶ button to select "Air", "STD", "HRC", or "IRC", then the **MENU** button. The message "Auto Program" is displayed.
➤ Contact your local cable company to identify the type of cable system that exists in your particular area.
5. Press the **ENTER** button to select "Start".
The TV will begin memorizing all of the available channels.
Press the **ENTER** button to stop.
➤ Refer to "Memorizing the Channels" on page 16.
6. After all available channels are stored, the "Time" is displayed.
Press the **ENTER** button.
Press the ◀ or ▶ button to move to the hour or minute. Set the clock by pressing the ▲ or ▼ button, then press the **MENU** button.
➤ Refer to "Setting the Time" on page 27.
7. The message "Enjoy your watching" is displayed, then the channel which has been stored will be activated.

If you want to reset this feature...

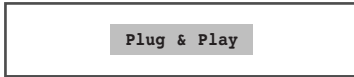
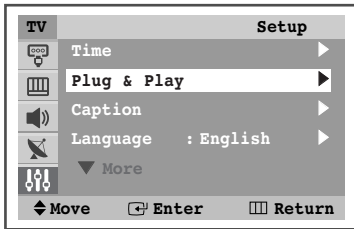

1. Press the **MENU** button to display the menu.
Press the **▲** or **▼** button to select "Setup", then press the **ENTER** button.
2. Press the **▲** or **▼** button to select "Plug & Play", then press the **ENTER** button.
For further details on setting up options, refer to the previous page.
➤ Plug & Play can only be accessed in the TV mode.

Changing Channels

Using the Channel Buttons

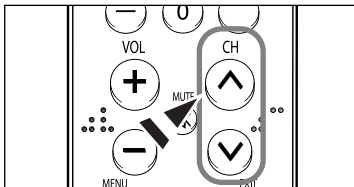

1. Press the **CH ^** or **CH v** button to change channels.
➤ When you press the **CH ^** or **CH v** button, the TV changes channels in sequence.
You will see all the channels that the TV has memorized. (The TV must have memorized at least three channels). You will not see channels that were either erased or not memorized. See page 16 to memorize channels.

Using the Number Buttons

Use the number buttons to quickly tune to any channel.

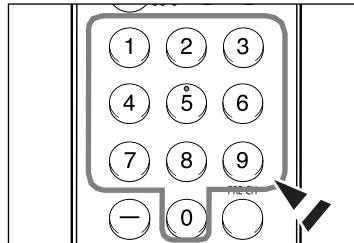

1. Press the number buttons to go directly to a channel.
For example, to select channel 27, press "2," then "7."
The TV will change channels when you press the second number.

Using the "-" Button

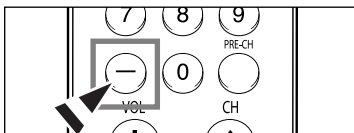

1. To select a channel over 100, for channel 122, press "-", then "2", then "2".

Using the PRE-CH Button to select the Previous Channel

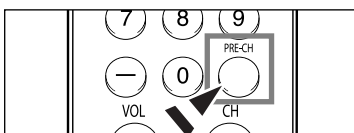

1. Press the **PRE-CH** button.
The TV will switch to the last channel viewed.
➤ To quickly switch between two channels that are far apart, tune to one channel, then use the number button to select the second channel. Then use the **PRE-CH** button to quickly alternate between them.

Adjusting the Volume

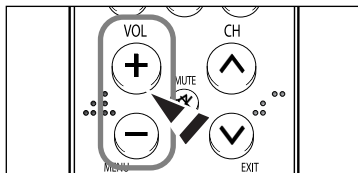

1. Press the **VOL +** or **VOL -** button to increase or decrease the volume.

Using Mute Button

At any time, you can cut off the sound using the **MUTE** button.

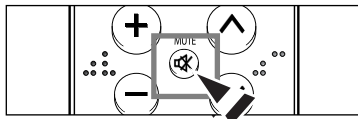

1. Press **MUTE** and the sound cuts off.
The word "**Mute**" will appear in the lower-left corner of the screen.
2. To turn mute off, press the **MUTE** button again, or simply press the **VOL +** or **VOL -** button.

Viewing the Display

The display identifies the current channel and the status of certain audio-video settings.

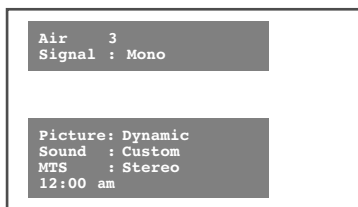

1. Press the **INFO** button on the remote control.

The TV will display the channel, the type of sound, and the status of certain picture and sound settings.

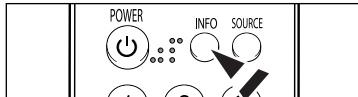

1. Press the **INFO** button once more or wait approximately 10 seconds and it disappears automatically.

Viewing the Menus

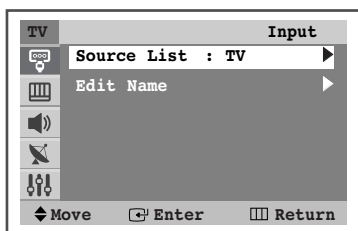

1. With the power on, press the **MENU** button.
The main menu appears on the screen. Its left side has five icons: Input, Picture, Sound, Channel, Setup.
2. Use the **▲** or **▼** button to select one of the five icons.
Then press the **ENTER** button to access the icon's sub-menu.
3. Press the **EXIT** button to exit.



- The on-screen menus disappear from the screen after a few seconds.

Memorizing the Channels

Your TV can memorize and store all of the available channels for both “off-air” (antenna) and cable channels. After the available channels are memorized, use the **CH ^** or **CH v** button to scan through the channels. This eliminates the need to change channels by entering the channel digits. There are three steps for memorizing channels: selecting a broadcast source, memorizing the channels (automatic) and adding and deleting channels (manual).

Selecting the Video Signal-source

Before your television can begin memorizing the available channels, you must specify the type of signal source that is connected to the TV (i.e. an antenna or a cable system).

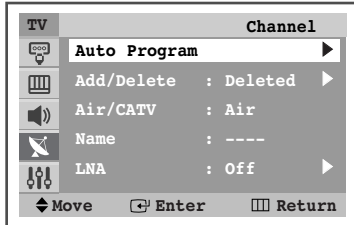

1. Press the **MENU** button to display the menu.
Press the **▲** or **▼** button to select “Channel”, then press the **ENTER** button.

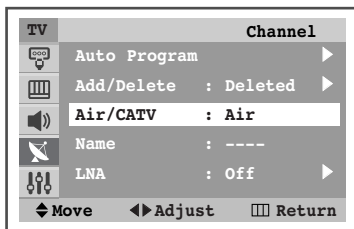

2. Press the **▲** or **▼** button to select “Air/CATV”, then press the **ENTER** button.
Press the **◀** or **▶** button to select “Air”, “STD”, “HRC”, or “IRC”.
Press the **EXIT** button to exit.

Storing Channels in Memory (Automatic Method)

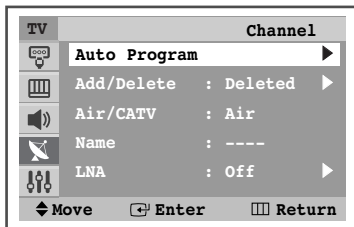

1. Press the **MENU** button to display the menu.
Press the **▲** or **▼** button to select “Channel”, then press the **ENTER** button.
2. Press the **ENTER** button to select “Auto Program”, then press the **ENTER** button.

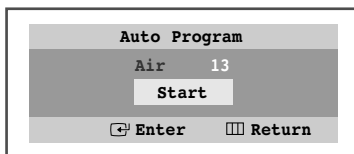

3. Press the **ENTER** button to start the auto program.
The TV begins memorizing all available channels.
Press the **ENTER** button at any time to interrupt the memorization process.
Press the **EXIT** button to exit.

To Select the Source

Use to select TV or other external input sources connected to the TV.
Use to select the input source of your choice.

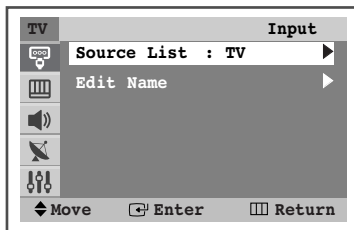

1. Press the **MENU** button to display the menu.
Press the **ENTER** button to select "Input".

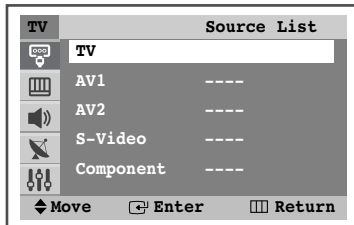

2. Press the **ENTER** button to select "Source List".
Press the **▲** or **▼** button to select signal source, then press the **ENTER** button.
➤ When you connect equipment to the TV, you can choose between the following sets of jacks: AV1, AV2, or Component on the TV's rear panel and AV2 or S-Video on the TV's side panel.

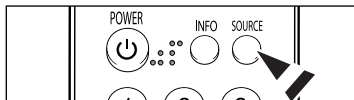

- Press the **SOURCE** button on the remote control to view an external signal source.

To Edit the Input Source Name

Name the device connected to the input jacks to make your input source selection easier.

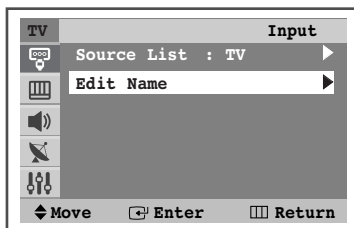

1. Press the **MENU** button to display the menu.
Press the **ENTER** button to select "Input".
Press the **▲** or **▼** button to select "Edit Name", then press the **ENTER** button.

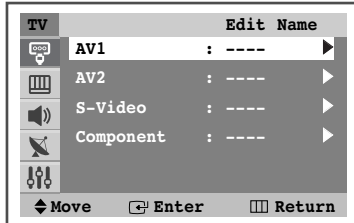

2. Press the **▲** or **▼** button to select "AV1", "AV2", "S-Video" or "Component" input jack, then press the **ENTER** button.

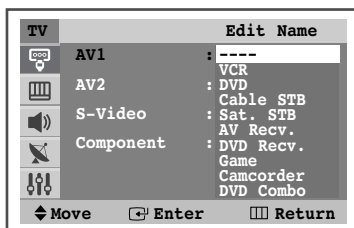

3. Press the **▲** or **▼** button to select "VCR", "DVD", "Cable STB", "Sat. STB", "AV Recv.", "DVD Recv.", "Game", "Camcorder" or "DVD Combo" input source, then press the **ENTER** button.
Press the **EXIT** button to exit.

Picture Control

Using Automatic Picture Settings

Your TV has four automatic picture settings (“Dynamic”, “Standard”, “Movie”, “Custom”) that are preset at the factory. You can activate either Dynamic, Standard, Movie, or Custom by making a selection from the menu.

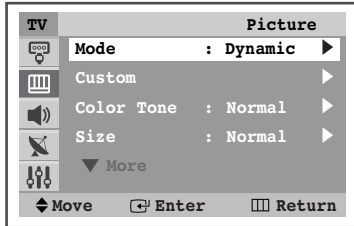

1. Press the **MENU** button to display the menu.
Press the **▲** or **▼** button to select “Picture”, then press the **ENTER** button.

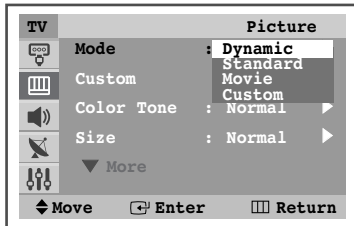

2. Press the **ENTER** button to select “Mode”.
Press the **▲** or **▼** button to select the “Dynamic”, “Standard”, “Movie”, or “Custom” picture setting, then press the **ENTER** button.

- Choose **Dynamic** to increase the clarity and sharpness of the picture.
- Choose **Standard** for the standard factory settings.
- Choose **Movie** when watching movies.
- Choose **Custom** if you want to adjust the settings according to personal preference.

Press the **EXIT** button to exit.

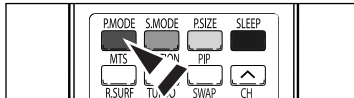

- Press the **P.MODE** button on the remote control to select one of the standard picture settings.

Customizing the Picture

You can use the on-screen menus to change the “Contrast”, “Brightness”, “Sharpness”, “Color” and “Tint” according to personal preference. (Alternatively, you can use one of the “Automatic” setting.)

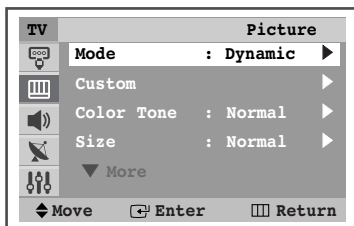

1. Press the **MENU** button to display the menu.
Press the **▲** or **▼** button to select “Picture”, then press the **ENTER** button.

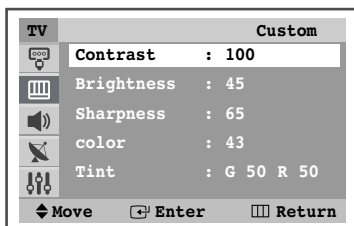

2. Press the **▲** or **▼** button to select “Custom”, then press the **ENTER** button.
Press the **▲** or **▼** button to select “Contrast”, “Brightness”, “Sharpness”, “Color”, or “Tint”, then press the **ENTER** button.

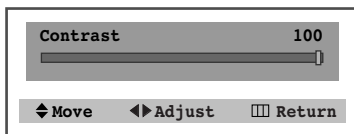

3. Press the **◀** or **▶** button to decrease or increase the value of a particular item.

Press the **EXIT** button to exit.

- After adjusting an item, the gauge will automatically disappear (after about 10 seconds).

Adjusting the Color Tone

You can change the color of the entire screen according to your preference.

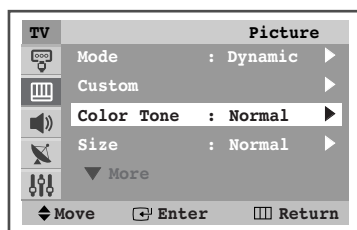

1. Press the **MENU** button to display the menu.
Press the **▲** or **▼** button to select "Picture", then press the **ENTER** button.
2. Press the **▲** or **▼** button to select "Color Tone", then press the **ENTER** button.

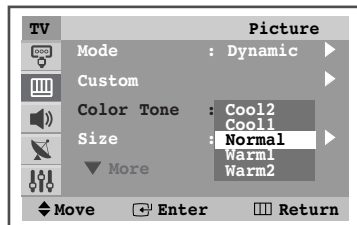

3. Press the **▲** or **▼** button to select "Cool2", "Cool1", "Normal", "Warm1", or "Warm2", then press the **ENTER** button.
Press the **EXIT** button to exit.

Changing the Screen Size

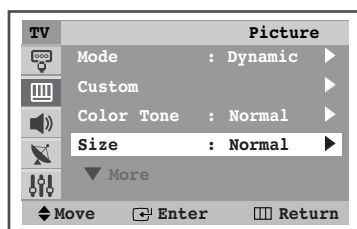

1. Press the **MENU** button to display the menu.
Press the **▲** or **▼** button to select "Picture", then press the **ENTER** button.
2. Press the **▲** or **▼** button to select "Size", then press the **ENTER** button.

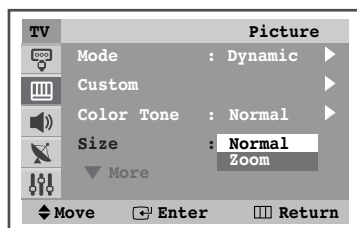

3. Press the **▲** or **▼** button to select the desired size, then press the **ENTER** button.
Press the **EXIT** button to exit.

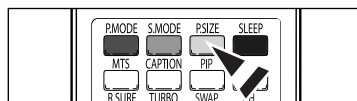

- Press the **P.SIZE** button on the remote control to change the picture size.

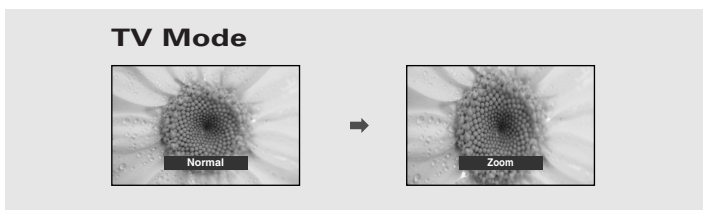

Digital Noise Reduction

If the broadcast signal received by your TV is weak, you can activate the Digital Noise Reduction feature to help reduce any static and ghosting that may appear on the screen.

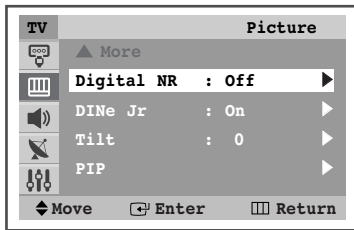

1. Press the **MENU** button to display the menu.
Press the **▲** or **▼** button to select "Picture", then press the **ENTER** button.
2. Press the **▲** or **▼** button to select "Digital NR", then press the **ENTER** button.

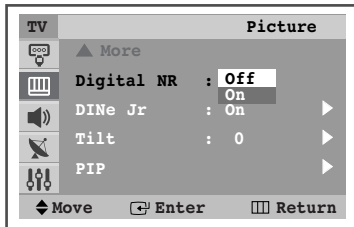

3. Press the **▲** or **▼** button to select "On", then press the **ENTER** button.
Press the **EXIT** button to exit.

DNiE Jr(Digital Natural Image engine Junior) (depending on the model)

This feature bring you more detailed image with detail enhancement, contrast enhancement and white enhancement. New image compensation algorithm gives brighter, clearer, much detailed image to you. DNiE Jr technology will fit every signals into your eyes.

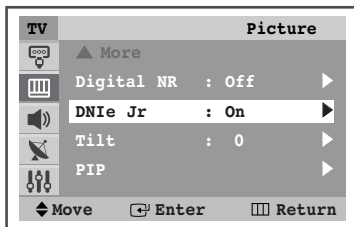

1. Press the **MENU** button to display the menu.
Press the **▲** or **▼** button to select "Picture", then press the **ENTER** button.
2. Press the **▲** or **▼** button to select "DNiE Jr", then press the **ENTER** button.

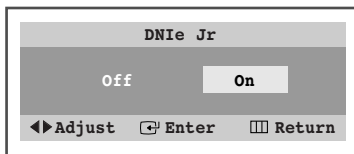

3. Press the **◀** or **▶** button to select "On", then press the **ENTER** button.
Press the **EXIT** button to exit.

Tilt (depending on the model)

Due to the Earth's magnetic field there may be some minor image tilt depending on the TV's location. When this occurs, follow the steps below.

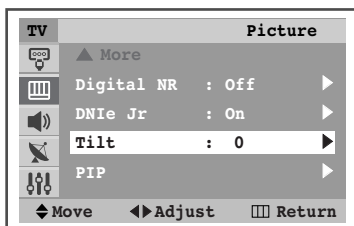

1. Press the **MENU** button to display the menu.
Press the **▲** or **▼** button to select "Picture", then press the **ENTER** button.
2. Press the **▲** or **▼** button to select "Tilt", then press the **ENTER** button.
Press the **◀** or **▶** button to adjust screen tilt.
Press the **EXIT** button to exit.

Viewing Picture-in-Picture (depending on the model)

You can display a sub picture within the main picture of TV program or external A/V devices such as VCR or DVD. In this way you can watch TV program or monitor the video input from any connected devices while watching TV or other video input.

Activating Picture-in-Picture

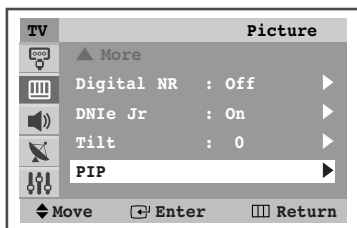

1. Press the **MENU** button to display the menu. Press the **▲** or **▼** button to select "Picture", then press the **ENTER** button. Press the **▲** or **▼** button to select "PIP", then press the **ENTER** button.

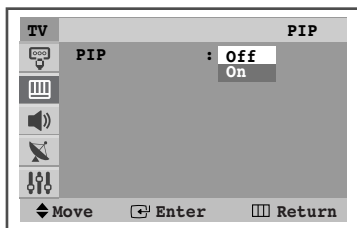

2. Press the **ENTER** button again. Press the **▲** or **▼** button to select "On", then press the **ENTER** button.
 - > If you turn the TV off while watching in PIP mode and turn it on again, the PIP window will disappear.

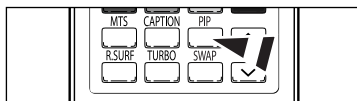

3. Press the **PIP** button on the remote control to activate or deactivate the PIP.

PIP Settings

O: PIP operates / X: PIP doesn't operate

Main Picture \ Sub Picture	TV	AV 1	AV 2	S-Video	Component
TV	O	O	O	O	X
AV 1	O	O	O	O	X
AV 2	O	O	O	O	X
S-Video	O	O	O	O	X
Component	X	X	X	X	X

Selecting a Signal Source (External A/V) for PIP.

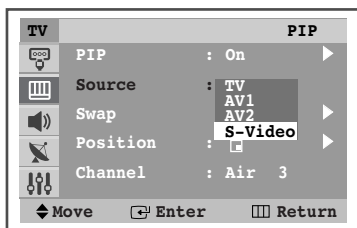

3. Press the **▲** or **▼** button to select "Source", then press the **ENTER** button. Select the source of the sub picture (PIP) by pressing the **▲** or **▼** button and press the **ENTER** button.

Swapping the Contents of the PIP and Main Picture

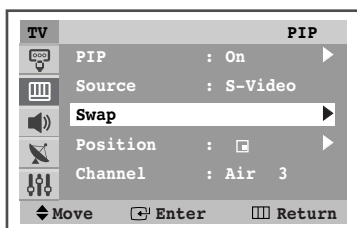

4. Press the **▲** or **▼** button to select "Swap", then press the **ENTER** button.

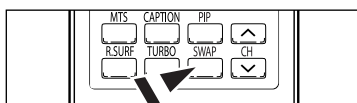

3. Press the **SWAP** button on the remote control to interchange the main picture and the sub picture.

Continued...

Changing the Position of the PIP Window

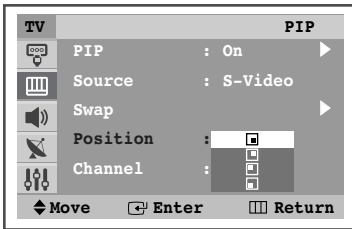

5. Press the ▲ or ▼ button to select "Position", then press the **ENTER** button. Press the ▲ or ▼ button to select the desired PIP window position, then press the **ENTER** button.

Changing the PIP Channel

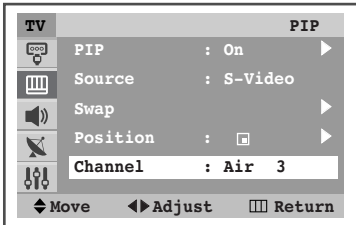

6. Press the ▲ or ▼ button to select "Channel", then press the ◀ or ▶ button to select the desired channel in the PIP window.

Press the **EXIT** button to exit.

➤ The channel can be active when the sub picture is set to TV.

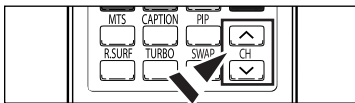

- Press the PIP ^ CH v button on the remote control.

Sound Control

Using Automatic Sound Settings

Your TV has automatic sound settings ("Standard", "Music", "Movie", "Speech", and "Custom") that are preset at the factory. Or, you can select "Custom", which automatically recalls your personalized sound settings.

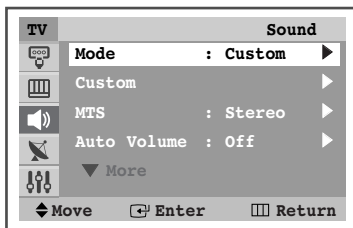

1. Press the **MENU** button to display the menu. Press the ▲ or ▼ button to select "Sound", then press the **ENTER** button.

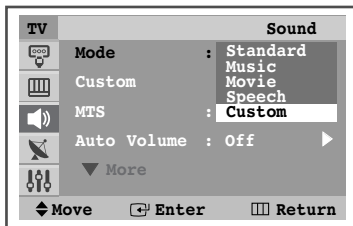

2. Press the **ENTER** button to select "Mode". Press the ▲ or ▼ button to select "Standard", "Music", "Movie", "Speech", or "Custom" sound setting, then press the **ENTER** button.

Press the **EXIT** button to exit.

- Choose **Standard** for the standard factory settings.
- Choose **Music** when watching music videos or concerts.
- Choose **Movie** when watching movies.
- Choose **Speech** when watching a show that is mostly dialog (i.e., news).
- Choose **Custom** to recall your personalized settings (see "Customizing the Sound").

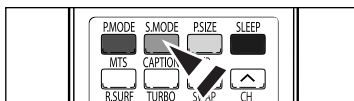

- Press the **S.MODE** button on the remote control to select one of the standard sound settings.

Customizing the Sound

The sound settings can be adjusted to suit your personal preference. (Alternatively, you can use one of the “Automatic” settings.)

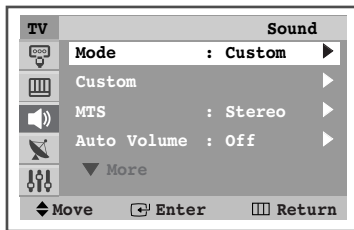

1. Press the **MENU** button to display the menu. Press the **▲** or **▼** button to select “Sound”, then press the **ENTER** button. Press the **▲** or **▼** button to select “Custom”, then press the **ENTER** button.

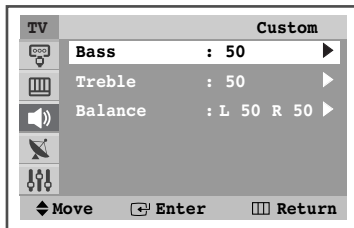

2. Press the **▲** or **▼** button to select “Bass”, “Treble”, or “Balance”, then press the **ENTER** button.

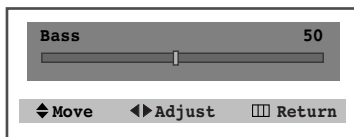

3. Press the **◀** or **▶** button to decrease or increase the value of a particular item. Press the **EXIT** button to exit.

Choosing a Multi-Channel Sound (MTS) track

Multi-Track Sound

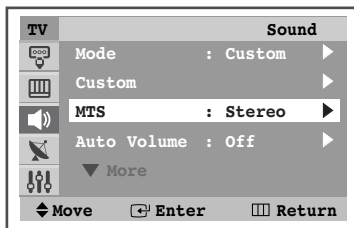

1. Press the **MENU** button to display the menu. Press the **▲** or **▼** button to select “Sound”, then press the **ENTER** button.

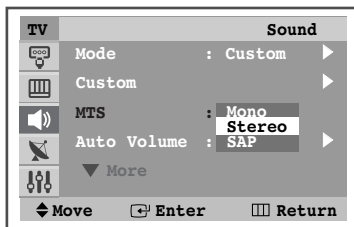

2. Press the **▲** or **▼** button to select “MTS”, then press the **ENTER** button. Press the **▲** or **▼** button to select a setting you want, then press the **ENTER** button.

Press the **EXIT** button to exit.

- Choose **Mono** for channels that are broadcasting in mono, or if you are having difficulty receiving a stereo signal.
- Choose **Stereo** for channels that are broadcasting in stereo.
- Choose **SAP** to listen to the Separate Audio Program, which is usually a foreign-language translation.

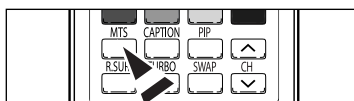

1. Press the **MTS** button on the remote control to select “Mono”, “Stereo”, or “SAP”.

Automatic Volume Control

Reduces the differences in volume level among broadcasters.

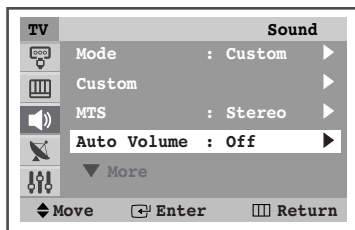

1. Press the **MENU** button to display the menu.
Press the **▲** or **▼** button to select "Sound", then press the **ENTER** button.
2. Press the **▲** or **▼** button to select "Auto Volume", then press the **ENTER** button.

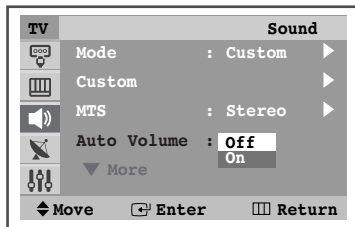

3. Press the **▲** or **▼** button to select "Off" or "On", then press the **ENTER** button.
Press the **EXIT** button to exit.

Turbo Sound

"Turbo Sound" emphasizes the bass and treble frequencies to add fullness to the sound.

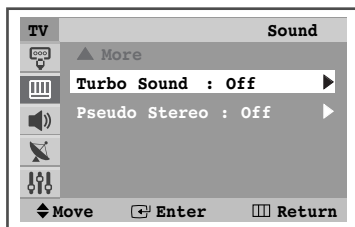

1. Press the **MENU** button to display the menu.
Press the **▲** or **▼** button to select "Sound", then press the **ENTER** button.
2. Press the **▲** or **▼** button to select "Turbo Sound", then press the **ENTER** button.

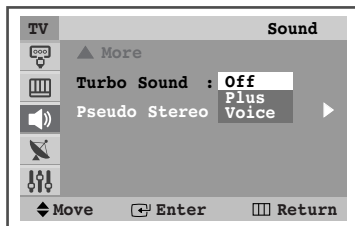

3. Press the **▲** or **▼** button to select the required item, then press the **ENTER** button.

Press the **EXIT** button to exit.

- Off/Plus/Voice or On/Off (depending on the model)
Quick way to access the Turbo Sound:
Just press the **TURBO** button on the remote control.

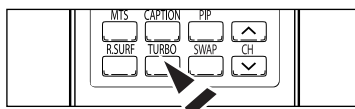

Pseudo Stereo

"Pseudo Stereo" converts a monaural sound signal into two identical left and right channels. Once the "Pseudo Stereo" is set to "Off" or "On", the setting applies to the sound effects such as "Standard", "Music", "Movie" and "Speech".

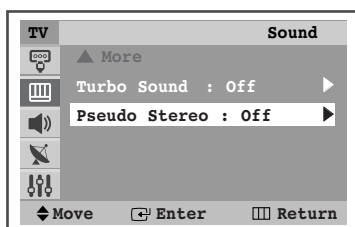

1. Press the **MENU** button to display the menu.
Press the **▲** or **▼** button to select "Sound", then press the **ENTER** button.
2. Press the **▲** or **▼** button to select "Pseudo Stereo", then press the **ENTER** button.

Continued...

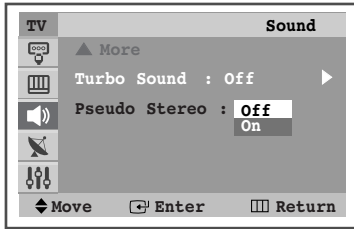

3. Press the ▲ or ▼ button to select “Off” or “On”, then press the **ENTER** button.

Press the **EXIT** button to exit.

Channel Control

Adding and Erasing Channels

You can add or delete a channel to display the channels you want only.

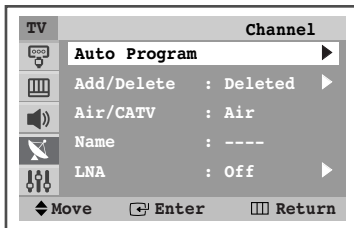

1. Press the **MENU** button to display the menu. Press the ▲ or ▼ button to select “Channel”, then press the **ENTER** button.
2. Press the ▲ or ▼ button to select “Add/Delete”, then press the **ENTER** button.

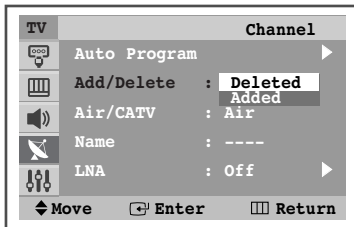

3. Press the ▲ or ▼ button to select “Added” or “Deleted”, then press the **ENTER** button.

Press the **EXIT** button to exit.

Labeling Channels

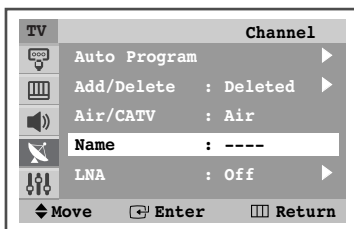

1. Press the **MENU** button to display the menu. Press the ▲ or ▼ button to select “Channel”, then press the **ENTER** button. Press the ▲ or ▼ button to select “Name”, then press the **ENTER** button.

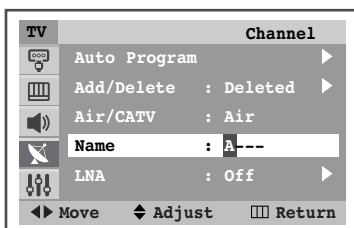

2. Press the ▲ or ▼ button to select a letter, a number or a blank (Results in this sequence: A...Z, *, blank, 0...9). Press the ► button to switch to the next field, which will be selected. Select a second letter or digit by pressing the ▲ or ▼ button, as above. Repeat the process to select the last two digits. When you have finished, press the **MENU** button to assign the new name.

Press the **EXIT** button to exit.

- When you use a cable card to watch cable broadcasting, it may take some time for a channel name to be displayed due to the time it takes to receive data.
- If you add or delete the TV channel, the corresponding label information will also be added or deleted.

LNA (Low Noise Amplifier) (depending on the model)

If the TV is operating in a weak-signal area, sometimes the LNA function can improve the reception (a low-noise preamplifier boosts the incoming signal).

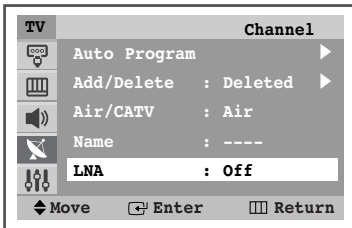

1. Press the **MENU** button to display the menu.
Press the **▲** or **▼** button to select "Channel", then press the **ENTER** button.
2. Press the **▲** or **▼** button to select "LNA", then press the **ENTER** button.

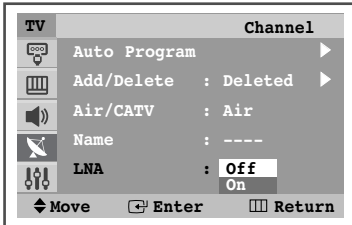

3. Press the **▲** or **▼** button to select "Off" or "On", then press the **ENTER** button.
Press the **EXIT** button to exit.
 - If the picture is noisy with the LNA set to On, select Off.
 - The LNA setting must be made separately for each channel.

Using the R.Surf Feature

This feature allows you to set the TV to return to a particular channel after a certain amount of time. For example, you may be watching a channel when commercials start. You can set the R.Surf to "5 minutes", then switch channels. After 5 minutes, the TV will return to the original channel. To use the R.Surf feature:

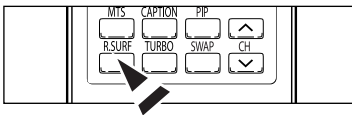

1. While you are watching the channel to which you want to return, press the **R.SURF** button. The "Surf Off" is displayed.
2. Press the **R.SURF** button again to set the timer in thirty second intervals, up to five minutes.
 - The time will start decreasing while you are setting up the timer, and will reset after 5 minutes has passed or you turn it off.
3. The time you set will begin counting down on the screen. When the time runs out, the TV will return to the channel you were watching when you set the timer.

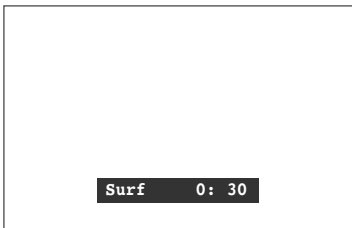

Time Setting

Setting the Time

Setting the clock is necessary in order to use the various timer features of the TV. Also, you can check the time while watching the TV. (Just press the INFO button.)

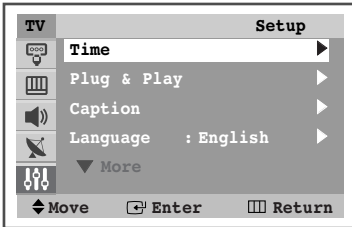

1. Press the **MENU** button to display the menu. Press the **▲** or **▼** button to select "Setup", then press the **ENTER** button. Press the **ENTER** button to select "Time".

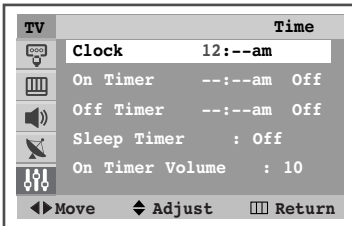

2. Press the **◀** or **▶** button to move to the hour or minute. Set the clock by pressing the **▲** or **▼** button, then press the **MENU** button. Press the **EXIT** button to exit.

➤ The current time will appear every time you press the **INFO** button.

Setting the On/Off Timer

You can preset a time to turn the TV On or Off.

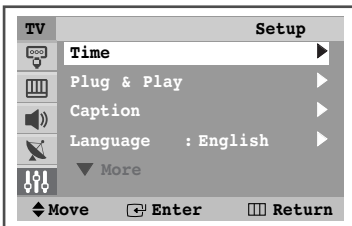

1. Press the **MENU** button to display the menu. Press the **▲** or **▼** button to select "Setup", then press the **ENTER** button. Press the **ENTER** button to select "Time".

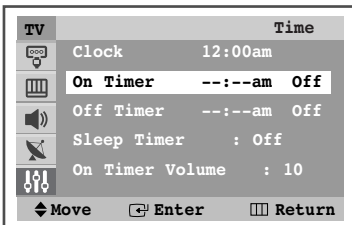

2. Press the **▲** or **▼** button to select "On Timer", then press the **ENTER** button.

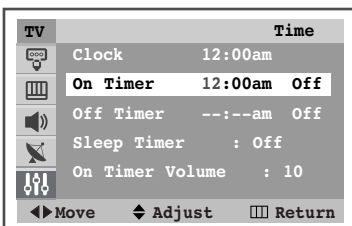

3. Press the **◀** or **▶** button to move to the hour or minute. Set the clock by pressing the **▲** or **▼** button. Press the **◀** or **▶** button to move to "Off". To activate the "On Timer", set to "On" by pressing the **▲** or **▼** button.
 - When finished, press the **MENU** button to return.
 - **Auto Power Off**

When you set the timer "On", the TV will eventually turn off, if no controls are operated for 3 hours after the TV was turned on by timer. This function is only available in timer "On" mode and prevents overheating, which may occur if a TV is on for too long.

Continued...

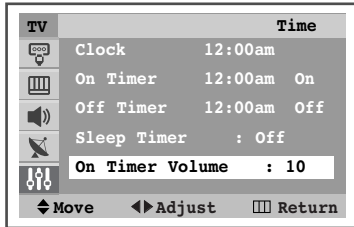

- Press the **ENTER** button to select "Time".
- Press the **▲** or **▼** button to select "On Timer Volume", then press the **◀** or **▶** button to adjust volume level.

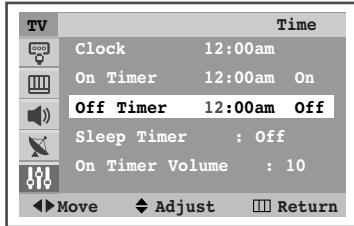

- Press the **▲** or **▼** button to select "Off Timer", then press the **ENTER** button.
- Press the **◀** or **▶** button to move to the hour or minute. Set the clock by pressing the **▲** or **▼** button. Press the **◀** or **▶** button to move to "Off". To activate the "Off Timer", set to "On" by pressing the **▲** or **▼** button. Press the **EXIT** button to exit.

Setting the Sleep Timer

The sleep timer automatically shuts off the TV after a preset time (from 30 to 180 minutes).

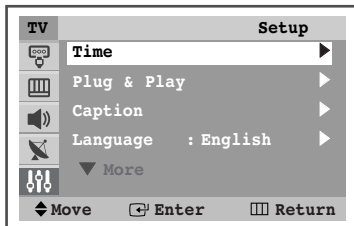

- Press the **MENU** button to display the menu. Press the **▲** or **▼** button to select "Setup", then press the **ENTER** button. Press the **ENTER** button to select "Time".

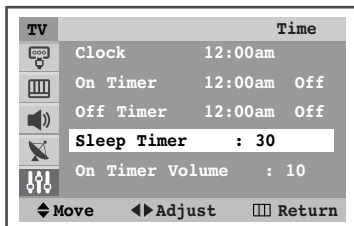

- Press the **▲** or **▼** button to select "Sleep Timer", then press the **◀** or **▶** button to select the appropriate time interval. Press the **EXIT** button to exit.

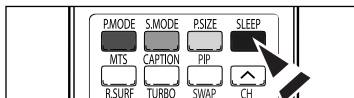

- Press the **SLEEP** button on the remote control until the appropriate time interval appears (any of the preset values from "30 min" to "180 min").

Function Description

Viewing Closed Captions(On-Screen Text Messages)

The Caption function operates in either analog RF channel mode or external signal mode. (Depending on the broadcasting signal, the Caption function may operate on digital channels.)

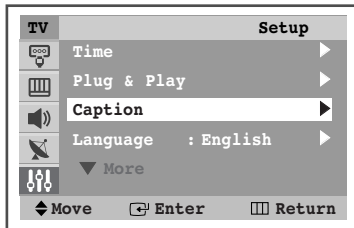

1. Press the **MENU** button to display the menu.
Press the **▲** or **▼** button to select "Setup", then press the **ENTER** button.
2. Press the **▲** or **▼** button to select "Caption", then press the **ENTER** button.

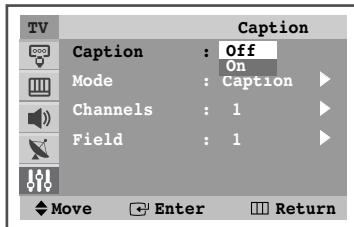

3. Press the **ENTER** button to select "Caption".
Press the **▲** or **▼** button to select "On", then press the **ENTER** button.

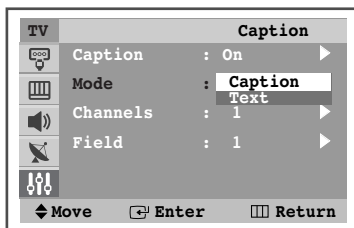

4. Press the **▲** or **▼** button to select "Mode", then press the **ENTER** button.
Press the **▲** or **▼** button to select "Caption" or "Text", then press the **ENTER** button.
 - In "Caption" mode, captions appear at the bottom of the screen, and they usually cover only a small portion of the picture.
 - In "Text" mode, information unrelated to the program, such as news or weather, is displayed. Text often covers a large portion of the screen.

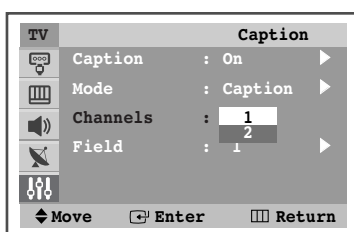

5. Press the **▲** or **▼** button to select "Channels", then press the **ENTER** button.
Press the **▲** or **▼** button to select "1" or "2", then press the **ENTER** button.

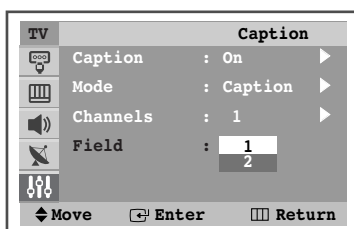

6. Press the **▲** or **▼** button to select "Field", then press the **ENTER** button.
Press the **▲** or **▼** button to select "1" or "2", then press the **ENTER** button.
 - • Different channels and fields display different information: Field 2 carries additional information that supplements the information in Field 1.
(For example, Channel 1 may have subtitles in English, while Channel 2 has subtitles in Spanish.)
 - The availability of captions depends on the program being broadcast.

Press the **EXIT** button to exit.

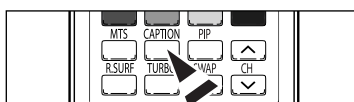

- Press the **CAPTION** button on the remote control to select "On" or "Off".

Selecting a Menu Language

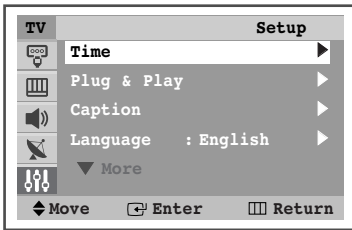

1. Press the **MENU** button to display the menu.
Press the **▲** or **▼** button to select "Setup", then press the **ENTER** button.
Press the **▲** or **▼** button to select "Language".

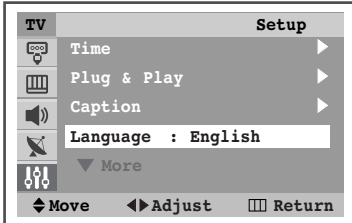

2. Press the **◀** or **▶** button to select the appropriate language: "English", "Español", or "Français", then press the **MENU** button.
Press the **EXIT** button to exit.

Setting the Blue Screen Mode

If no signal is being received or the signal is very weak, a blue screen automatically replaces the noisy picture background.
If you wish to continue viewing the poor picture, you must set the "Blue Screen" mode to "Off"



1. Press the **MENU** button to display the menu.
Press the **▲** or **▼** button to select "Setup", then press the **ENTER** button.

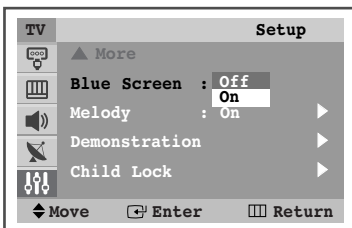

2. Press the **▲** or **▼** button to select "Blue Screen", then press the **ENTER** button.
Press the **▲** or **▼** button to select "Off" or "On", then press the **ENTER** button.
Press the **EXIT** button to exit.

Setting the On/Off Melody

A melody sound can be set to come on when the TV is powered On or Off.



1. Press the **MENU** button to display the menu.
Press the **▲** or **▼** button to select “Setup”, then press the **ENTER** button.

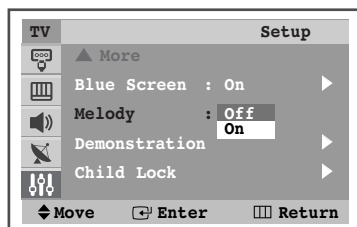

2. Press the **▲** or **▼** button to select “Melody”, then press the **ENTER** button.
Press the **▲** or **▼** button to select “Off” or “On”, then press the **ENTER** button.
Press the **EXIT** button to exit.

Viewing the Demonstration

To become familiar with the various menus provided by your television, you can view the in built demonstration.

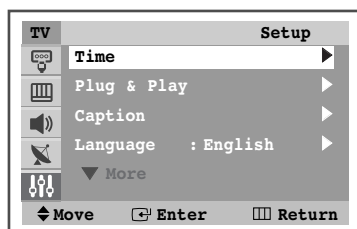

1. Press the **MENU** button to display the menu.
Press the **▲** or **▼** button to select “Setup”, then press the **ENTER** button.

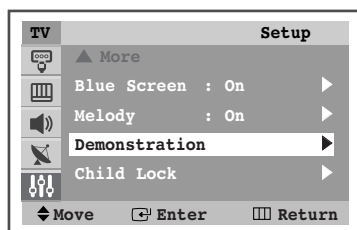

2. Press the **▲** or **▼** button to select “Demonstration”, then press the **ENTER** button.
Each of the menu options is displayed in turn. When you wish to stop the demonstration, press any button on the remote control.

Locking the Channel

This feature allows you to prevent unauthorized users, such as children, from watching unsuitable programmes by muting out video and audio. Child Lock cannot be released using front (or side) panel buttons. Only remote control can release the Child Lock setting, so keep the remote control away from children.

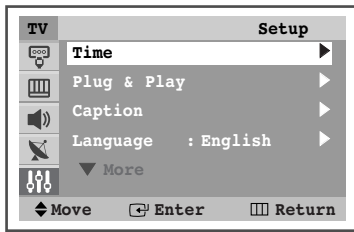

1. Press the **MENU** button to display the menu.
Press the **▲** or **▼** button to select "Setup", then press the **ENTER** button.

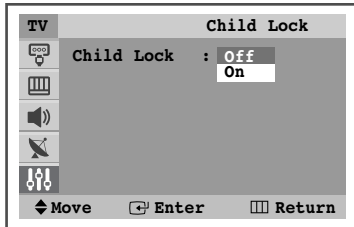

2. Press the **▲** or **▼** button to select "Child Lock", then press the **ENTER** button.
Press the **ENTER** button again, then press the **▲** or **▼** button to select "On".
➤ If you want to unlock a channel, set to "Off".

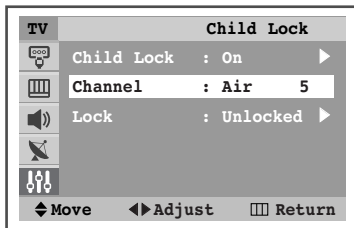

3. Press the **▲** or **▼** button to select "Channel", then press the **◀** or **▶** button to select the channel to be locked.

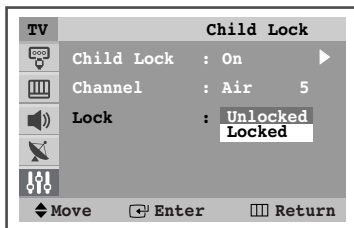

4. Press the **▲** or **▼** button to select "Lock", then press the **ENTER** button.
➤ If any channel is locked, you can not access to the "Channel" and "Child Lock" menu by using the control buttons on the TV panel (the "Not Available" is displayed in the "Child Lock" menu). You can access by using the remote control only.
5. Press the **▲** or **▼** button to select "Unlocked" or "Locked".
Press the **EXIT** button to exit.

Appendix

Identifying Problems

If the TV seems to have a problem, first try this list of possible problems and solutions.
If none of these troubleshooting tips apply, call your nearest Samsung service center.

Problem	Possible Solution
Poor picture	Try another channel. Adjust the antenna. Check all wire connections.
Poor sound quality.	Try another channel. Adjust the antenna.
No picture or sound.	Try another channel. Press the SOURCE button. Make sure the TV is plugged in. Check the antenna connections. Make sure the MUTE button is off.
No sound or sound is too low at maximum volume.	First, check the volume of units connected to your TV (digital broadcasting receiver, DVD, cable broadcasting receiver, VCR, etc.). Then, adjust the TV volume accordingly.
Picture rolls vertically.	Check all wire connections.
The TV operates erratically.	Unplug the TV for 30 seconds, then try operating it again.
The TV won't turn on.	Make sure the wall outlet is working.
Remote control malfunctions	Replace the remote control batteries. Clean the upper edge of the remote control (transmission window). Check the battery terminals. Make sure the remote has batteries. Check that the "+" and "-" ends of the batteries are inserted correctly.
The image is too light or too dark.	Adjust the Brightness and Contrast. Adjust the Fine tuning.

Specifications

Model Name	CL-29Z30	CL-29Z40
Power Supply	AC100~240V 50/60H AC120V 60Hz(Mexico)	AC100~240V 50/60Hz
Power Consumption	140W	140W
Sound Output	10W + 10W	10W + 10W
Dimensions (W x D x H)	36.7 x 15.9 x 22.3 inches 796 x 415 x 586 mm	30.4 x 16.5 x 23.3 inches 771 x 420 x 593 mm
Weight	42.0 Kg / 92.6 lbs	41.0 Kg / 90.4 lbs



Contact SAMSUNG WORLD-WIDE

If you have any questions or comments relating to Samsung products, please contact the SAMSUNG customer care center.

Country	Customer Care Center ☎	Web Site
ARGENTINE	0800-333-3733	www.samsung.com/ar
BRAZIL	0800-124-421	www.samsung.com/br
CHILE	800-726-7864 (SAMSUNG)	www.samsung.com/cl
COSTA RICA	0-800-507-7267	www.samsung.com/latin
ECUADOR	1-800-10-7267	www.samsung.com/latin
EL SALVADOR	800-6225	www.samsung.com/latin
GUATEMALA	1-800-299-0013	www.samsung.com/latin
JAMAICA	1-800-234-7267	www.samsung.com/latin
MEXICO	01-800-SAMSUNG (7267864)	www.samsung.com/mx
PANAMA	800-7267	www.samsung.com/latin
PUERTO RICO	1-800-682-3180	www.samsung.com/latin
REP. DOMINICA	1-800-751-2676	www.samsung.com/latin
TRINIDAD & TOBAGO	1-800-7267-864	www.samsung.com/latin
VENEZUELA	1-800-100-5303	www.samsung.com/latin