



RCA

Television User's Guide



Changing Entertainment. Again.







Important Information

WARNING
 To reduce the risk of fire or electric shock, do not expose this product to rain or moisture.

	CAUTION RISK OF ELECTRIC SHOCK DO NOT OPEN	
CAUTION: TO REDUCE THE RISK OF ELECTRIC SHOCK, DO NOT REMOVE COVER (OR BACK). NO USER SERVICEABLE PARTS INSIDE. REFER SERVICING TO QUALIFIED SERVICE PERSONNEL.		

 This symbol indicates "dangerous voltage" inside the product that presents a risk of electric shock or personal injury.

 This symbol indicates important instructions accompanying the product.

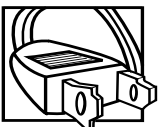

Caution: To prevent electric shock, match wide blade of plug to wide slot, fully insert.

Attention: Pour éviter les chocs électriques, introduire la lame la plus large de la fiche dans la borne correspondante de la prise et pousser jusqu'au fond.

Refer to the identification/rating label located on the back panel of your product for its proper operating voltage.

FCC Regulations state that unauthorized changes or modifications to this equipment may void the user's authority to operate it.

If fixed (non-moving) images are left on the screen for long periods, they may be permanently imprinted on the picture tube. Such images include network logos, phone numbers, and video games. This damage is not covered by your warranty. Extended viewing of channels displaying these images should be avoided.

Cable TV Installer: This reminder is provided to call your attention to Article 820-40 of the National Electrical Code (Section 54 of the Canadian Electrical Code, Part 1) which provides guidelines for proper grounding and, in particular, specifies that the cable ground shall be connected to the grounding system of the building as close to the point of cable entry as practical.

Product Registration

Please fill out the product registration card (packed separately) and return it immediately. Returning this card allows us to contact you if needed.

Product Information

Keep your sales receipt to obtain warranty parts and service and for proof of purchase. Attach it here and record the serial and model numbers in case you need them. The numbers are located on your product.

Model No. _____

Serial No. _____

Purchase Date: _____

Dealer/Address/Phone: _____



Key Features Overview

Your TV is equipped with features that will add to your viewing experience. The following information summarizes these features. Chapter 3 provides more information about the rest of the TV's features and how to use them.

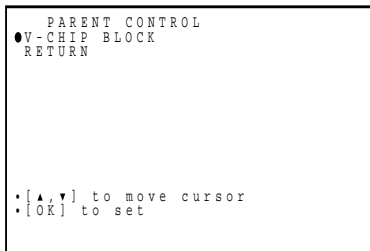
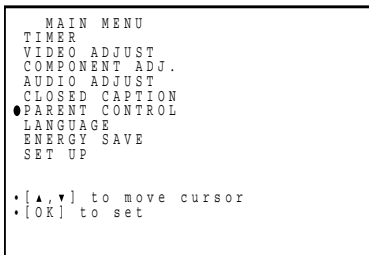

TV back panel

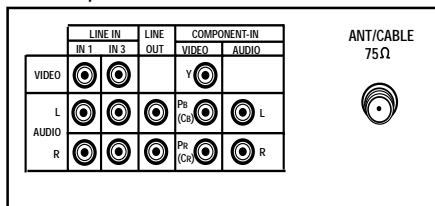

V-Chip: Parental Controls

Description: You can block programs and movies by content, age-based ratings, and/or movie ratings.

Requirements:

- Set up the *TV GUIDELINES* and *MPAA* menus in the TV's main *MENU* (Chapter 3 has details).
- The broadcasters must use the rating system when they send the program to your TV in order for your TV to block the program.

Component Input Jacks

Description: The jacks on the back of your TV labeled COMPONENT-IN can be used to connect a component with Component Output jacks (like a DVD player). Component video connections provide a higher quality picture because the video signal is divided into three parts instead of being compressed into one.

Requirements: A component with Component Output jacks, and three video grade cables that you'll use to connect the component to your TV.



PIP (Picture-In-Picture)

Description: PIP lets you watch two channels at one time — one channel on the main screen and the other in a smaller window.

Requirements: Press the PIP button on the remote control. Go to page X for more information about PIP.



(This page intentionally left blank)





Table of Contents

Introduction:

Key Features Overview	1
V-Chip: Parental Controls	1
Component Input Jacks	1
PIP (Picture-In-Picture)	1

Chapter 1: Setup and Connections

Things to Consider Before You Connect	6
Protect Against Power Surges	6
Protect Components from Overheating	6
Position Cables Properly to Avoid Audio Interference	6
Important Stand and Base Safety Information	6
Use Indirect Light	6
Choose Your Connection	7
Cables Needed to Connect Components to Your TV	7
Connection: TV + VCR	8
Connection: TV + VCR + DVD Player	9
Connection: TV + VCR + Satellite Receiver	11
Plug in the TV	12
Put Batteries in the Remote	12
How to Use the Remote Control to Complete the Initial Setup	12
Turn on the TV	12
Initial Setup	13
Select a Language	13
Auto Preset (Automatically Searching for Channels)	13
Add or Erase Channels	14

Chapter 2: The Remote Control

The Buttons on the Remote Control	16
Programming the Remote to Operate Other Components	18
Find Out If You Need to Program the Remote	18
How to Program the Remote	18
How to Use the Remote After You've Programmed It	19
How to Order A New Remote Control	19



Table of Contents

Chapter 3: Using the TV's Features

The PIP (Picture-In-Picture) Feature	22
How V-Chip Works	23
New Rating Systems	23
Parent Controls and V-Chip	23
Set the MPAA Rating Limits	24
Set the TV GUIDELINES Rating Limits	25
Entering Your Secret Number	27
Download New Rating System	27
Turning V-Chip Block On and Off	28

Chapter 4: Using the TV's Menu System

How to Use Your TV's Menu System	30
TIMER Menu	30
To set the clock.	30
Accessing Menus	30
Exiting from a menu	30
To set the on timer or sleep timer.	31
VIDEO ADJUST Menu	32
COMPONENT ADJUST Menu	32
AUDIO ADJUST Menu	33
CLOSED CAPTION Menu	34
PARENT CONTROL — go to Chapter 3	34
LANGUAGE Menu	34
Additional Settings in the SETUP Menu	35
The ENERGY SAVE Menu	35

Chapter 5: Additional Information

Troubleshooting	38
Back Panel (listed left to right)	40
Front Panel (listed alphabetically)	40
Limited Warranty	41
Care and Cleaning	43
Finding the TV's Video Line Input Channel	43
Accessories	45
Index	47



Chapter 1

Connections & Setup

Chapter Overview:

- Things to Consider Before You Connect
- Choose Your Connection
- Connections
- Plug in the TV
- Put Batteries in the Remote Control
- Turn on the TV
- Initial Setup

Changing Entertainment. Again.



Graphics used within this publication are for representation only.



Connections & Setup

Things to Consider Before You Connect

Protect Against Power Surges

- Connect all components before you plug any of their power cords into the wall outlet.
- Turn off the TV and/or component before you connect or disconnect any cables.
- Make sure all antennas and cables are properly grounded. Refer to the Important Safeguards sheet packed with your TV.

Protect Components from Overheating

- Don't block ventilation holes on any of the components. Arrange the components so that air can circulate freely.
- Don't stack components.
- When you place components in a stand, make sure you allow adequate ventilation.
- If you connect an audio receiver or amplifier, place it on the top shelf so the heated air from it won't flow around other components.

Position Cables Properly to Avoid Audio Interference

- Insert each cable firmly into the designated jack.
- If you place components above the TV, route all cables down the side of the back of the TV instead of straight down the middle of the back of the TV.
- If your antenna uses 300-ohm twin lead cables, do not coil the cables. Also, keep the twin lead cables away from audio/video cables.

Important Stand and Base Safety Information

Choose the location for your TV carefully. Place the TV on a stand or base that is of adequate size and strength to prevent the TV from being accidentally tipped over, pushed off, or pulled off. This could cause personal injury and/or damage to the TV. Refer to the Important Safeguards sheet packed with your TV.

Use Indirect Light





Don't place the TV where sunlight or room lighting will be directed toward the screen. Use soft or indirect lighting.

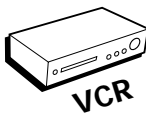
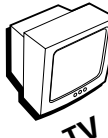

Connections & Setup

Choose Your Connection

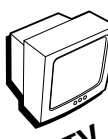
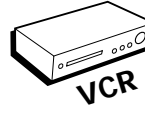
There are several ways to connect your TV. Please use the following chart to determine which connection is best for you. Proceed to the appropriate page, and connect your TV.

Components	Connection Title	Go To
 	TV +VCR	page 8
  	TV + VCR + DVD Player	page 9
  	TV + VCR + Satellite Receiver	page 10

Cables Needed to Connect Components to Your TV

The pictures below show the cables needed for the connections represented in this book.

Note: Audio/Video cables (A/V cables for short) are usually sold as a bundled set, but the connection picture in this book shows each cable separately for better visibility.

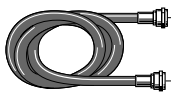

RF Coaxial cable

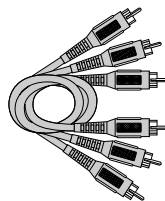

Audio/video cables

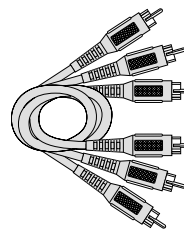

Video grade cables



Connections & Setup

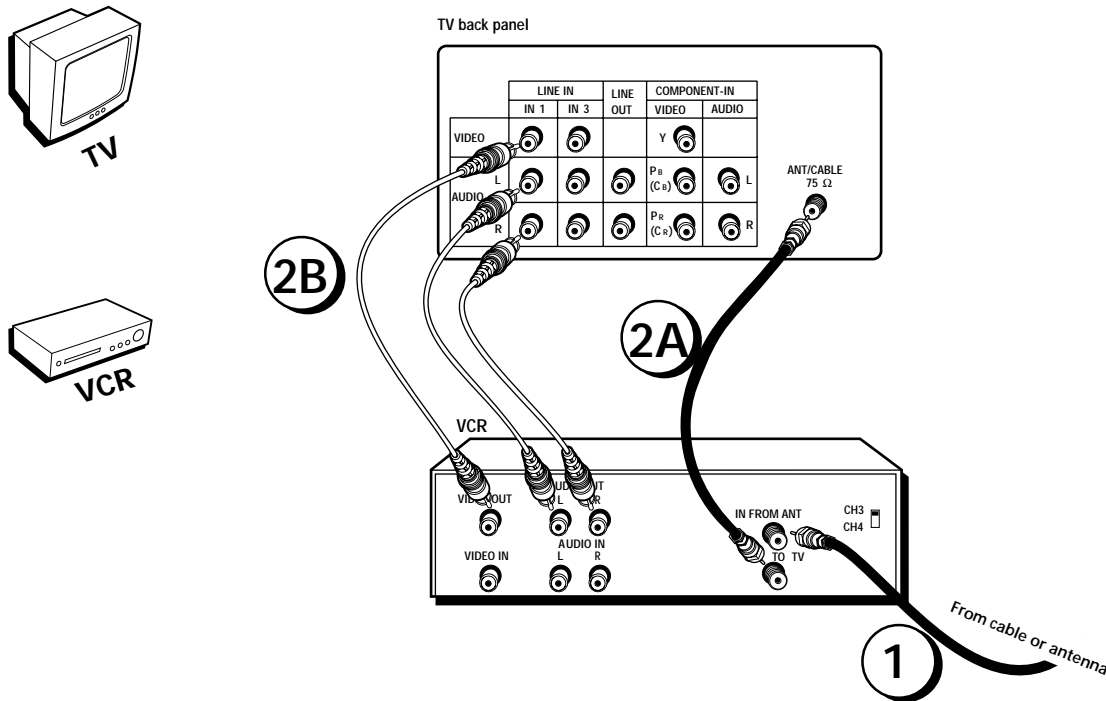

Note: The back of your VCR might not look exactly like the one shown here.

Connection: TV + VCR

1. Connect your cable or antenna to your VCR

Connect the RF coaxial cable from your cable feed, cable box, or off-air antenna to the IN FROM ANTENNA jack on your VCR (sometimes labeled IN FROM ANT).

2. Connect your VCR to your TV

- Connect a coaxial cable to the OUT TO TV jack on your VCR (sometimes labeled OUT TO TV), and to the ANT/CABLE jack on the back of the TV.
- Connect audio/video cables. Connect the video cable (yellow) to the IN 1 VIDEO jack on the back of the TV and to the Video Output jack on the VCR (sometimes labeled VIDEO OUT). Connect the audio cables (white and red) to the IN 1 AUDIO L and R jacks on the TV, and to the corresponding Output jacks on the VCR (sometimes labeled AUDIO OUT L and R).

Go to page 12

Connections & Setup

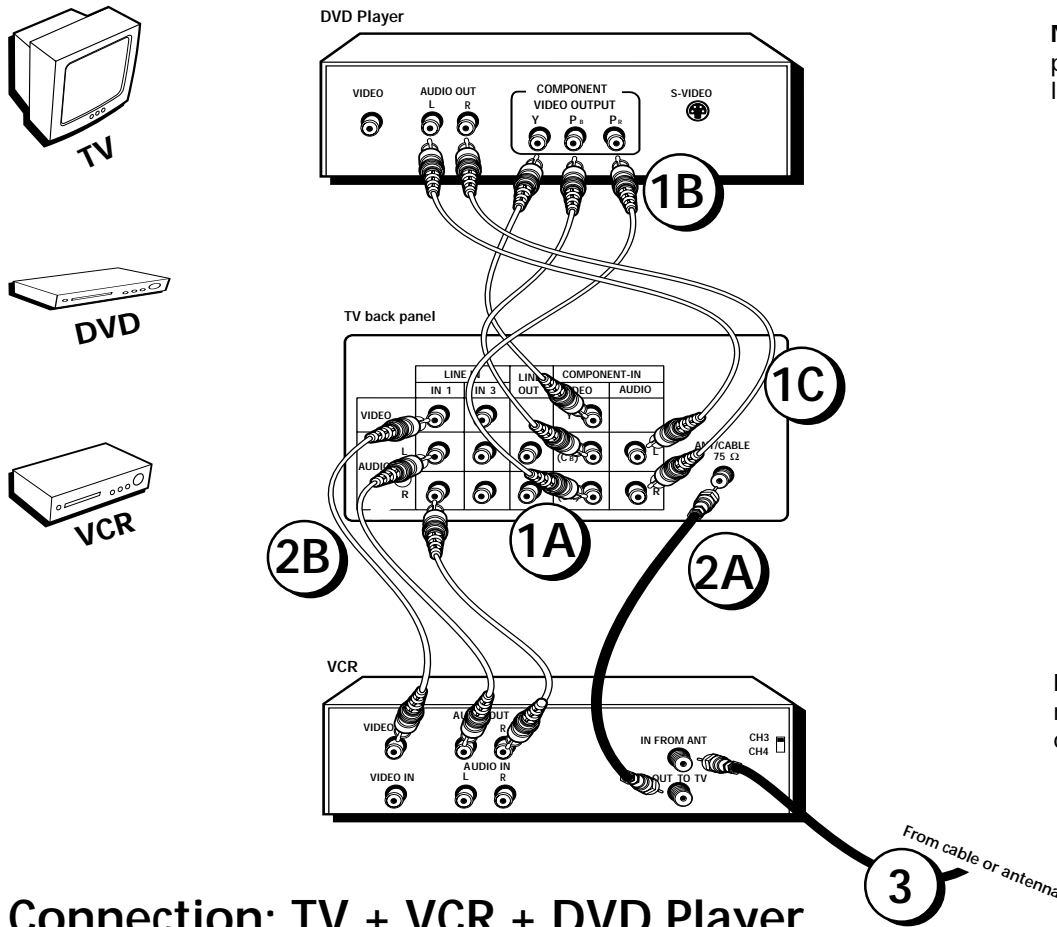

Note: The back of your DVD player might not look exactly like the one shown here.

Note: The back of your VCR might not look exactly like the one shown here.

Connection: TV + VCR + DVD Player

1. Connect your DVD Player to your TV

Note: if your DVD Player doesn't have Component jacks, use audio/video cables to connect the DVD Player to the TV's AUDIO L and R and VIDEO jacks.

- Connect three video grade cables to the COMPONENT-IN VIDEO jacks on the back of the TV— labeled Y, P_B (C_B), P_R (C_R).
- Connect the other ends of the video cables to the corresponding Component Output Jacks on your DVD Player (sometimes labeled Y, P_b, P_r).
- Connect audio cables to the COMPONENT-IN jacks labeled AUDIO L and R and to the Audio Output jacks on the DVD Player (sometimes labeled AUDIO OUT L and R).

2. Connect your VCR to your TV

- Connect a coaxial cable to the OUT TO TV jack on your VCR (sometimes labeled OUT TO TV), and to the ANT./CABLE jack on the back of the TV.
- Connect audio/video cables. Connect the video cable (yellow) to the IN 1 VIDEO jack on the back of the TV and to the Video Output jack on the VCR (sometimes labeled VIDEO OUT). Connect the audio cables (white and red) to the IN 1 AUDIO L and R jacks on the TV, and to the corresponding Output jacks on the VCR (sometimes labeled AUDIO OUT L and R).

3. Connect your cable or antenna to your VCR

Connect the RF coaxial cable from your cable feed, cable box, or off-air antenna to the IN FROM ANTENNA jack on your VCR (sometimes labeled IN FROM ANT).

Go to page 12

Connections & Setup

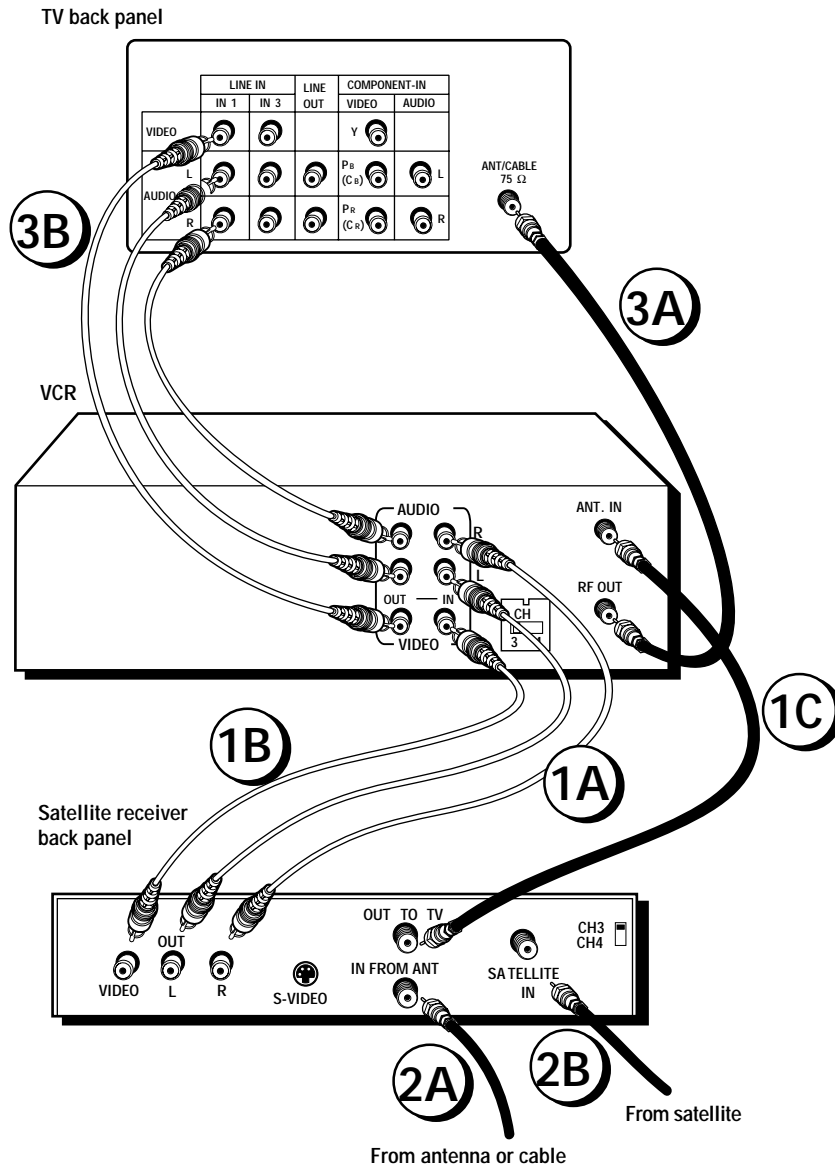
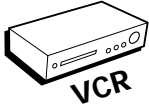
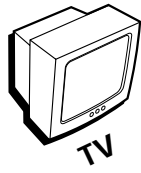

Note: The back of your VCR and satellite receiver might not look exactly like the ones shown here.



Connections & Setup

Connection: TV + VCR + Satellite Receiver

1. Connect your satellite receiver to your VCR

- A. Connect the audio/video cables. Connect the audio cables (white and red) to the Audio Input jacks on the VCR (sometimes labeled AUDIO IN L and R) and to the Audio Output Jacks on the satellite receiver (sometimes labeled OUT L and R).
- B. Connect the video cable (yellow) to the Video Input jack on the VCR (sometimes labeled VIDEO IN) and to the Video Output Jack on the satellite receiver (sometimes labeled VIDEO OUT).
- C. Connect a coaxial cable from the satellite receiver's OUT TO TV jack and to the Antenna Input jack on the VCR (sometimes labeled ANT IN).

2. Connect coaxial cables to the satellite receiver

- A. Connect the coaxial cable from your cable feed or antenna to the Input Jack on your satellite receiver (sometimes labeled IN FROM ANT).
- B. If it's not already connected, make sure you connect the coaxial cable from your satellite dish antenna to the Input Jack on your satellite receiver (sometimes labeled SATELLITE IN).

3. Connect your VCR to your TV

- A. Connect a coaxial cable to the Output Jack (sometimes labeled RF OUT) on the VCR and to ANT/CABLE jack on the TV.
- B. Connect audio/video cables. Connect audio cables to the Audio Output jacks on the VCR, and to the IN 1 AUDIO L and R jacks on the TV. Connect the video cable (yellow) to the Video Output jack on the VCR, and to the IN 1 VIDEO jack on the TV.

Go to page 12



Connections & Setup

Plug in the TV

Plug the end of the power cord into the wall outlet. Match the wide blade of the plug with the wide slot in the outlet. Insert the plug completely into the outlet.

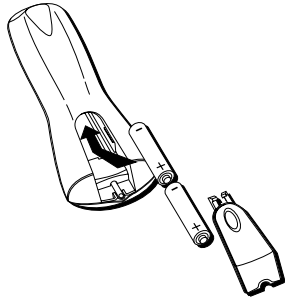

Put Batteries in the Remote

1. Remove the battery compartment cover on the remote.
2. Insert new batteries. Match the polarities (+ and -) on the batteries with the diagram on the remote.
3. Put the battery compartment cover back on the remote.

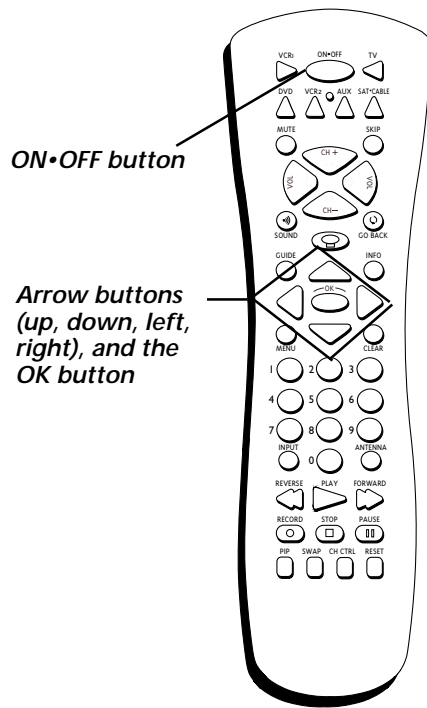

How to Use the Remote Control to Complete the Interactive Setup

The technical term is called “navigation” – how you move through the on-screen menus. The theory is the same throughout the menu screens: highlight your choice and select it.

To highlight or point to an item on the screen, press the arrow buttons on the remote (you’ll notice the circle moves). Use the up or down arrow button to move up or down respectively. Use the left or right arrow buttons to move left or right respectively.

To select an item you’ve highlighted (i.e., it has the circle next to it), press the OK button.

Turn on the TV

To turn on the TV, press the ON•OFF button on the remote or the POWER on the front of the TV (the POWER indicator on the front of the TV lights).

Initial Setup

The first time you turn on your TV, you'll be asked to set a few menu screens so that your TV will set up correctly. Complete the following steps to set up your TV. The other options in the *SET UP* menu are explained in Chapter 4.

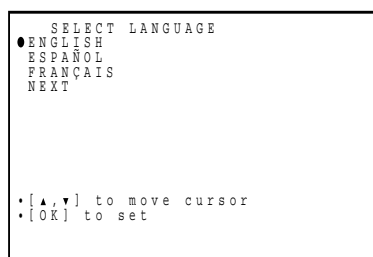

Select a Language

The first time you turn on the TV, the *SELECT LANGUAGE* menu appears on the screen. If you want the on-screen menus to appear in English, press the OK button on the remote control. If you want the on-screen menus to appear in a different language, follow these steps.

1. Press the down arrow on the remote to highlight *ESPAÑOL* (Spanish) or *FRANÇAIS* (French).
2. Press OK to select the language.
3. Press the down arrow button to highlight *NEXT*, and press OK (a menu appears asking you if you want to *START AUTO PRESET?*)

Note: If you need to change the language later, you can access this menu from the Main menu - go to page 34 for instructions.

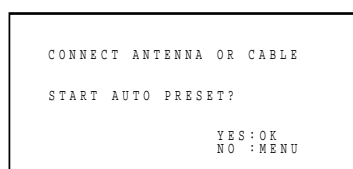
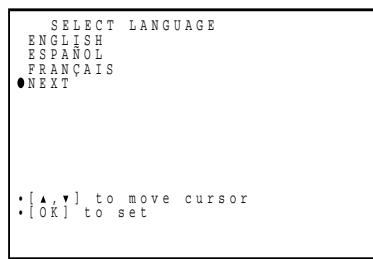

Auto Preset (Automatically Searching for Channels)

Auto Preset enables the TV to search for all of the channels that are viewable through your cable TV connection or off-air antenna.

1. If you've connected your antenna or cable, press the OK button on the remote (auto programming starts).

Note: If you want to stop the auto programming, press MENU.

When the search is complete the TV will automatically tune to the first channel in the channel list.

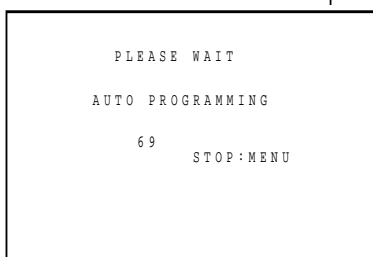

Connections & Setup

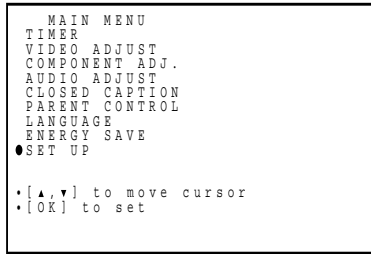

Add or Erase Channels

You might want to add or erase some channels if they're inactive, have weak signals, or you don't want them in your channel list. The channel list is the list of channels that the TV tunes to when you press the channel up and/or channel down buttons.

Note: Even if you erase a channel, you can still tune to it by pressing the number buttons on the remote control.

1. Press MENU on the remote (the main *MENU* appears).
2. Press down arrow button to highlight *SET UP*.
3. Press OK (the *SET UP* menu appears).
4. Press the down arrow button to highlight *CH MEMORY*.
5. Press OK (the *CH MEMORY* menu appears).

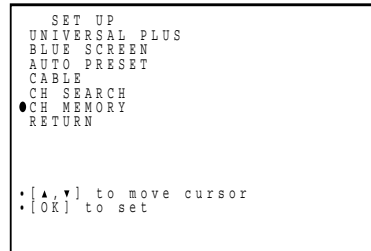

6. Follow the on-screen directions to *ADD* or *ERASE* a channel (press CH+ and/or CH -, or the number buttons to make different channel numbers appear).

- To add the channel that's shown on the screen to the TV's channel memory, press the right arrow button.

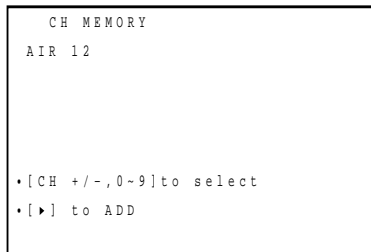

- To erase the channel listed on the screen, press the left arrow button.

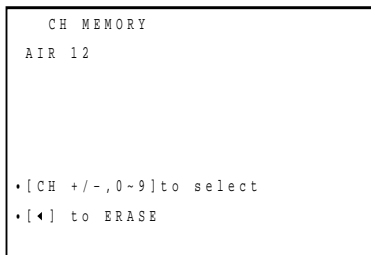

7. To exit, press MENU.

Chapter 2

Remote Control

Chapter Overview:

- The buttons on the remote control
- Programming the remote to operate other components
- How to use the remote after you've programmed it
- How to order a new remote control
- Code list

Changing Entertainment. Again.



Graphics used within this publication are for representation only.

The Remote Control

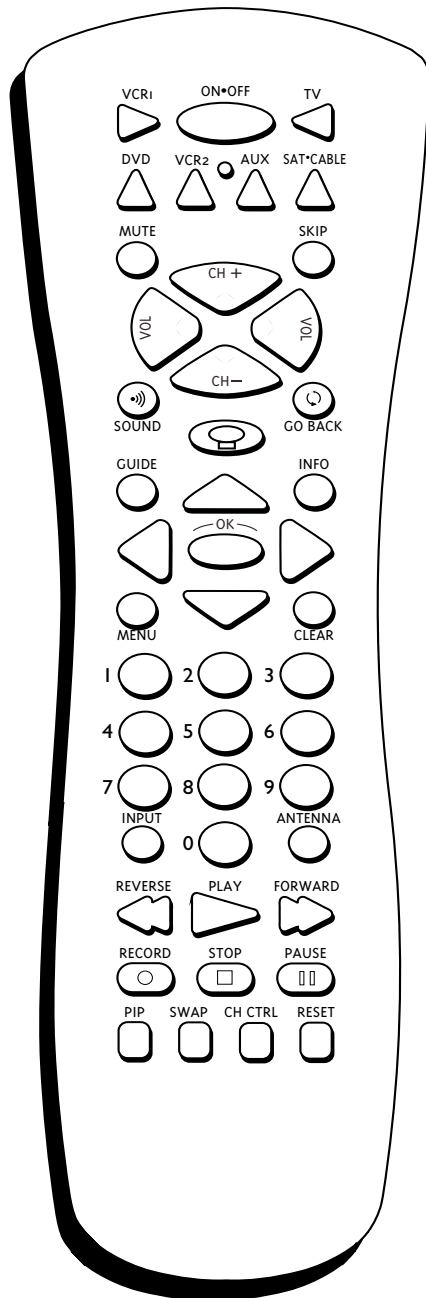

The Buttons on the Remote Control

Your backlit remote has a light button that glows in the dark. Press this button to light the channel up and channel down (CH +/-) and volume up and down (VOL </>) buttons. If you don't press any buttons for several seconds, the light turns off to conserve battery power.

0-9 (Number buttons) Enter channel numbers directly through the remote.

To enter a 2-digit channel, press the two digits. To enter a 3-digit channel, press and hold the first digit until two dashes appear on the screen (to the right of the first number), then add the next two digits. Example: to tune to channel 123, press and hold 1 until 1-- appears, press 2, then press 3.

ANTENNA Functions as TV/VCR button in VCR mode and TV/receiver button in SAT•CABLE mode.

Arrow buttons (up, down, right, and left) Press the arrow buttons to move through the on-screen menus.

AUX button Puts the remote in AUX mode.

CH (+ and -) buttons Scan up or down through stored channels. Press once to change the channel up or down; press and hold to continue changing channels. The remote must be in TV mode.

CH CTRL (Channel Control) Selects the picture window (main window or PIP window) that changes when you press the channel up or channel down button or the INPUT button.

CLEAR button Resets the time counter.

DVD button Puts the remote in DVD mode. Operates RCA, GE, and Proscan DVD Players.

FORWARD (fast forward) button Fast forwards a tape or disc, if you've programmed the remote to operate a VCR or DVD Player and you put the remote in the VCR or DVD mode.

GUIDE If this remote control operates a satellite receiver (most RCA, GE, and Proscan models), press GUIDE to see listings from your satellite service provider.

GO BACK button Returns you to the previous channel.

INFO button Displays TV/VCR's current status. Displays time counter when a tape is inserted. Press again to remove display.



The Remote Control

INPUT button Repeatedly press to select the TV tuner, or line inputs (*LINE 1* for the rear LINE IN/IN1 jacks, *LINE 3* for the rear LINE IN/IN3 jacks, *LINE 2* for the front VIDEO, L/MONO, R jacks or *COMPONENT* for the COMPONENT jacks).

L.E.D. (light-emitting diode) The little light on the remote that lights when you are programming the remote. It also lights when you press a valid button on the remote.

MENU button Displays the TV/VCR's main *MENU*.

MUTE button Lowers the TV volume to its minimum level and automatically turns on closed-captioning. Press again to restore volume and turn off closed-captioning.

ON•OFF button Turns the TV on and off. If the remote is in another component mode (VCR, DVD, SAT•CABLE, etc.) and has been programmed to operate other components, press the ON•OFF button to turn that component on and off.

PAUSE button Pauses a tape or disc during playback, if you've programmed the remote to operate a VCR or DVD Player and you put the remote in the VCR or DVD mode.

PIP (Picture-In-Picture) Brings up the small Picture-In-Picture window. Press again to remove the PIP window.

PLAY button Plays a tape or disc, if you've programmed the remote to operate a VCR or DVD Player and you put the remote in the VCR or DVD mode.

RECORD button Starts VCR recording if you've programmed the remote to operate your VCR and you put the remote in VCR mode.

RESET Returns the TV's settings to default settings.

REVERSE button Rewinds a tape or disc, if you've programmed the remote to operate a VCR or DVD Player and you put the remote in the VCR or DVD mode.

SAT•CABLE button Puts remote in cable or satellite mode.

SKIP button Press once before changing channels and the TV will wait 30 seconds before returning you to the original channel. Press repeatedly to add more time.

SOUND button Press to select stereo, SAP, or mono audio.

STOP button Stops the following playback functions: record, play, rewind, fast forward, and pause – if you've programmed the remote to operate a VCR or DVD Player and you put the remote in the VCR or DVD mode.

SWAP Used with PIP — switches between the main picture and the picture in the PIP window.

TV button Turns on the TV and puts remote in TV mode.

VCR1 Puts the remote in VCR mode, if you've programmed the remote to operate a VCR. Operate most RCA, GE, and Proscan VCRs.

VCR2 Puts the remote in VCR mode, if you've programmed the remote to operate a VCR.

VOL (< and >) buttons Decrease or increase the TV volume.





The Remote Control

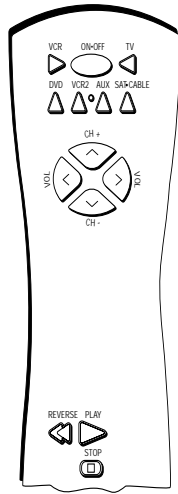

Programming the Remote to Operate Other Components

The universal remote control can be programmed to operate most brands of remote controllable VCRs, satellite receivers and cable boxes. The remote is already programmed to operate most RCA, GE and Proscan TVs, VCRs, DVD players, laserdisc players and satellite receivers.

Find Out If You Need to Program the Remote

To determine whether the universal remote needs to be programmed, turn a component ON, such as a VCR, point the remote at the VCR, and press the VCR1 button. Then press ON•OFF or channel up or channel down to see if the VCR responds to the remote commands. If not, the remote needs to be programmed.

You'll use these buttons when you program the remote to operate another component.

The remote may not operate all models of all brands.

How to Program the Remote

There are two ways to program the remote control: automatic code search and direct entry. Instructions for both ways follow.

Using Automatic Code Search

1. Turn on the component you want the remote to operate (VCR, satellite receiver, etc.).
2. Press and hold the component button on the remote control that corresponds to the component you want the remote to operate (VCR1, VCR2, etc.). While you hold down the component button, press and hold ON•OFF (when the red light on the remote turns on, release both buttons).
3. Press PLAY (the red light on the remote, located below the ON•OFF button, starts flashing).

The remote is searching the first set of component codes (there are 20 sets of codes). If the component you want to operate doesn't turn off automatically after 5 seconds, press PLAY again (the red light starts flashing again as the remote searches through the next set of codes).

Continue pressing PLAY until the component turns off.

Note: If the component doesn't turn off after you've pressed the PLAY button 20 times, the component can't be programmed.

4. Press REVERSE, wait 2 seconds. Repeat this step until the component turns back on.
5. To finish, press and hold the STOP button until the red light on the remote turns off.

Tip

To stop the automatic code search without programming any components, press and hold CLEAR until the light on the remote turns off.





The Remote Control

Using Direct Entry

1. Turn on the component you want the remote to operate.
2. Look up the brand and code number(s) for the component on the code list on page 20.
3. Press and hold component button that corresponds to the component you want the remote to operate (VCR1, VCR2, etc.)
4. Enter the code from the code list on page 20.
5. Release the component button.
6. Press ON•OFF to see if the component responds to the remote commands. If it doesn't, try pressing the component button and then ON•OFF again.
7. If you get no response, repeat these steps using the next code listed for your brand, until the component responds to the remote commands.

How to Use the Remote After You've Programmed It

Once the remote has been programmed successfully, you are ready to use it to control your components. To operate the component:

1. Press the component button (VCR1, VCR2, DVD, AUX, or SAT•CABLE) to set the remote to control the component.
2. Press ON•OFF to turn the component ON or OFF.
3. Use the remote buttons that apply to that component.

Notes:

- If you keep pressing buttons and nothing happens, the remote is probably in the wrong mode. You must press the component button that matches the component you want to operate (i.e., if you want to operate the VCR, press VCR1 on the remote control to put the remote in VCR mode.)
- The buttons might operate differently for other components, especially when you're using another component's menu system.

How to Order A New Remote Control

To order a new remote control or other accessories to use with your TV, go to Accessory information in Chapter 5.



Code List

VCR

Admiral	2131
Adventura	2026
Aiko	2027
Aiwa	2002, 2026
Akai	2003, 2004, 2005, 2007, 2008, 2111, 2112, 2113
American High	2021
Asha	2013
Audio Dynamics	2009, 2010
Audiovox	2014
Bell & Howell	2011
Beaumarck	2013
Broksonic	2012, 2025
Calix	2014
Candle	2013, 2014, 2015, 2016, 2017, 2018, 2019
Canon	2021, 2022, 2114
Capelhart	2020, 2110
Carver	2062
CCE	2027, 2061
Citizen	2013, 2014, 2015, 2016, 2017, 2018, 2019, 2027
Colortyme	2009
Colt	2061
Craig	2013, 2014, 2023, 2061
Curtis-Mathes	2000, 2002, 2009, 2013, 2016, 2018, 2021, 2022, 2024, 2115
Cybernex	2jn013
Daewoo	2015, 2017, 2019, 2025, 2026, 2027, 2028, 2110
Daytron	2110
Dbx	2009, 2010
Dimensia	2000
Dynatech	2002, 2026
Electrohome	2014, 2029
Electrophonic	2014
Emerson	2002, 2012, 2014, 2015, 2021, 2024, 2025, 2026, 2029, 2030, 2032, 2033, 2034, 2035, 2036, 2037, 2038, 2039, 2040, 2041, 2042, 2044, 2045, 2047, 2065, 2105, 2113, 2116, 2117, 2130
Fisher	2011, 2023, 2048, 2049, 2050, 2051, 2052, 2118
Fuji	2021, 2119
Funai	2002, 2026
Garrard	2026
GE	2000, 2001, 2013, 2021, 2022, 2053, 2115, 2120
Goldstar	2009, 2014, 2018, 2054, 2121
Gradiente	2026
Harley Davidson	2026
Harman Kardon	2009
Harwood	2061
Headquarter	2011
Hitachi	2002, 2055, 2056, 2057, 2107, 2111, 2120, 2122
HI-Q	2023
Instant Replay	2021
JCL	2021
JC Penney	2009, 2010, 2011, 2013, 2014, 2021, 2022, 2055, 2056, 2058, 2059, 2060, 2107, 2118
Jensen	2055, 2056, 2111
JVC	2009, 2010, 2011, 2018, 2058, 2111, 2123
Kenwood	2009, 2010, 2011, 2016, 2018, 2058, 2111, 2123
KLH	2061
Kodak	2014, 2021
Lloyd	2002, 2026
Logik	2061
LXI	2014
Magnavox	2021, 2022, 2062, 2063, 2104, 2108, 2124
Magnin	2013
Marantz	2009, 2010, 2011, 2016, 2018, 2021, 2058, 2062, 2064
Marta	2014
Masushita	2021
MEI	2021
Memorex	2002, 2011, 2013, 2014, 2021, 2023, 2026, 2104, 2131
MGA	2029, 2065, 2113
MGN Technology	2013
Midland	2053
Minolta	2055, 2056, 2107
Mitsubishi	2029, 2055, 2056, 2065, 2066, 2067, 2069, 2070, 2071, 2072, 2073, 2074, 2106, 2113, 2123
Montgomery Ward	2075, 2131
Motorola	2021, 2131
MTC	2002, 2013, 2026
Multitech	2002, 2013, 2016, 2026, 2053, 2061
NEC	2009, 2010, 2011, 2016, 2018,

.....	2058, 2064, 2076, 2078, 2079, 2111, 2123
Nikko	2014
Noblex	2013
Olympus	2021
Optimus	2014, 2131
Optonica	2096
Orion	2035
Panasonic	2021, 2022, 2109, 2125, 2126, 2127
Pentax	2016, 2055, 2056, 2107, 2120
Pentex Research	2018
Philco	2021, 2022, 2062, 2063
Philips	2021, 2062, 2096, 2124
Pilot	2014
Pioneer	2010, 2055, 2080, 2081, 2123
Portland	2016, 2017, 2019, 2110
ProScan	2000, 2001
Protec	2061
Pulsar	2104
Quarter	2011
Quartz	2011
Quasar	2021, 2022, 2125
RCA	2000, 2001, 2003, 2013, 2021, 2055, 2056, 2082, 2083, 2084, 2085, 2086, 2087, 2088, 2089, 2090, 2091, 2107, 2115, 2120, 2125
Radioshack/Realistic	2002, 2011, 2103, 2014
.....	2021, 2022, 2023, 2026, 2029, 2049, 2050, 2096, 2131
Radix	2014
Randex	2014
Ricoh	2128
Runco	2104
Samsung	2005, 2013, 2015, 2033, 2053, 2112
Sanky	2131, 2104
Sansui	2010, 2092, 2111, 2123
Sanyo	2011, 2013, 2023
Scott	2012, 2015, 2025, 2032, 2035, 2038, 2065, 2093, 2116
Sears	2011, 2014, 2021, 2023, 2048, 2049, 2050, 2051, 2055, 2056, 2107, 2118
Sharp	2002, 2017, 2029, 2094, 2095, 2096, 2131
Shintom	2004, 2056, 2061, 2098
Shogun	2013
Signature	2002, 2131
Singer	2021, 2061, 2128
Sony	2002, 2004, 2098, 2099, 2119, 2128
STS	2021, 2107
Sylvania	2002, 2021, 2022, 2026, 2062, 2063, 2065, 2124
Symphonic	2002, 2026
Tandy	2002, 2011
Tashiko	2014
Tatung	2058, 2111
TEAC	2002, 2026, 2058, 2085, 2111
Technics	2021, 2109
Teknika	2002, 2014, 2021, 2026, 2100, 2129
TMK	2013, 2024, 2047
Toshiba	2015, 2049, 2051, 2055, 2065, 2093, 2116
ToteVision	2013, 2014
Unitech	2013
Vector Research	2009, 2010, 2015, 2016
Victor	2010
Video Concepts	2009, 2010, 2015, 2016, 2113
Videosonic	2013
Wards	2002, 2013, 2014, 2015, 2021, 2023, 2026, 2029, 2055, 2056, 2061, 2096, 2101, 2102, 2103, 2107, 2116, 2131
XR-1000	2021, 2026, 2061
Yamaha	2009, 2010, 2011, 2018, 2058, 2111
Zenith	2004, 2098, 2104, 2119, 2128

GC Electronics	5009
Gemini	5018, 5019, 5049
General Instrument	5003
Hamlin	5020, 5021, 5022, 5035, 5045
Hitachi	5003
Hytex	5002
Jasco	5011
Jerrold	5003, 5005, 5007, 5018, 5023, 5024, 5046, 5053
Magnavox	5025
Memorex	5026
Movie Time	5002, 5027, 5028
NSC	5002, 5027, 5028
Oak	5002, 5016, 5029
Panasonic	5048, 5052
Paragon	5026
Philips	5011, 5012, 5013, 5019, 5025, 5030, 5031, 5032
Pioneer	5033, 5034
Pulsar	5026
RCA	5047, 5049, 5052
Realistic	5009, 5049
Regal	5022, 5035
Regency	5017
Rembrandt	5003
Runco	5026
Samsung	5014, 5034
Scientific Atlanta	5006, 5036, 5037, 5038
Signal	5014, 5018
Signature	5003
SL Marx	5014
Sprucer	5052
Starcom	5007, 5018, 5053
Stargate	5014, 5018
Starquest	5018
Tandy	5040
Televue	5014
Tocom	5004, 5023, 5041
Toshiba	5026
Tusa	5018
TV86	5027
Unika	5008, 5009, 5011
United Artists	5002
United Cable	5053
Universal	5008, 5009, 5010, 5011
Videoway	5044
Viewstar	5015, 5025, 5027, 5040
Zenith	5026, 5050, 5051

Satellite Receivers

Chapparral	5056, 5057
Drake	5058, 5059
GE	5000
General Instruments	5060, 5061, 5062
Panasonic	5075
Primestar	5076
ProScan	5000
RCA	5000
Realistic	5063
Sony	5072
STS1	5064
STS2	5065
STS3	5066
STS4	5067
Toshiba	5068
Toshiba	5073
Uniden	5069

Cable Boxes

ABC	5002, 5003, 5004, 5005, 5006, 5007, 5053
Antronix	5008, 5009
Archer	5008, 5009, 5010, 5011
Cabletenna	5008
Cableview	5008
Century	5011
Citizen	5011
Colour Voice	5012, 5013
Comtronics	5014, 5015
Contec	5016
Eastern	5017
Garrard	5011

Chapter 3

Using the TV's Features

Chapter Overview:

- PIP (Picture-In-Picture)
- Parental Controls and V-Chip

Changing Entertainment. Again.



Graphics used within this publication are for representation only.

Using the TV's Features

The PIP (Picture-In-Picture) Feature

The PIP (Picture-In-Picture) feature lets you display a second, smaller picture on top of the main picture.

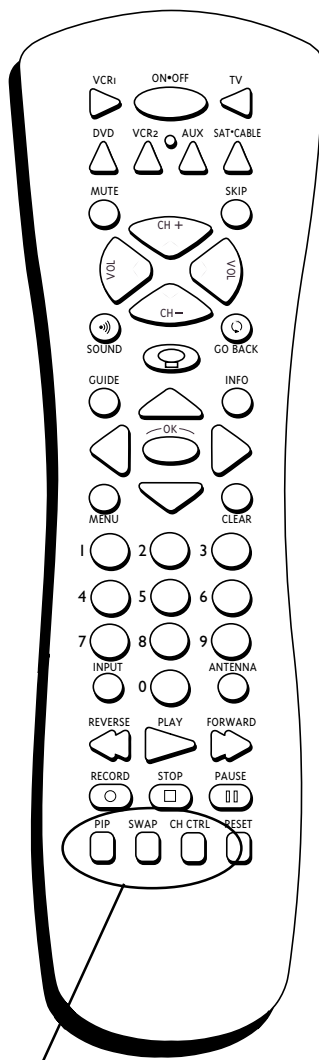

The main PIP buttons (PIP, CH CTRL and SWAP) are at the bottom of the remote control.

How To Use PIP

While you can use PIP in different ways, this basic PIP scenario should get you started.

1. The TV must be on. Tune to the channel you want to watch.
2. Press the PIP button on the remote (the PIP picture appears with the same picture in it as the main picture).
3. To change the picture in the PIP window, press the CH CTRL button on the remote control and then press the channel up or down buttons.
4. To change the channel in the main picture, press CH CTRL again and then press the channel up or down button on the remote control.

PIP Buttons: General Explanation

The buttons on the remote control that you'll use for the PIP feature are explained below:

PIP Press the PIP button to make the PIP window appear on the screen. Press PIP again to remove the window.

Right arrow button Moves the PIP window to different areas of the screen. Press and hold or just press.

CH CTRL (channel control) Lets you switch channel control between the PIP window and the main picture. To determine whether the remote control is the PIP picture or the main picture, look at the TV screen: the channel with the white circle next to it is the one you are controlling. Press CH CTRL to change which picture you're controlling.

SWAP Switches, or "swaps," where the two pictures appear on the TV screen. The smaller PIP picture swaps to the main screen and the main picture goes to the little PIP window.

Note: Swap won't work if the remote is in the wrong mode. For example, once you turn on the VCR with the VCR1 button, you can't SWAP the pictures until you put the remote in TV mode. Just press the TV button.



Using the TV's Features

```

MAIN MENU
TIMER
VIDEO ADJUST
COMPONENT ADJ.
AUDIO ADJUST
CLOSED CAPTION
● PARENT CONTROL
LANGUAGE
ENERGY SAVE
SET UP

• [▲,▼] to move cursor
• [OK] to set

```

Parent Controls and V-Chip

The *PARENT CONTROL* feature allows you to program your TV so that children can't see certain programs or channels.

- *MPAA* menu allows you to block movies and TV programs according to the MPAA (Motion Pictures Association of America) ratings system.
- *TV GUIDELINES* menu allows you to block TV programs based on age, violence, sex, or other content you don't want your children to view.

```

PARENT CONTROL
● V-CHIP BLOCK
RETURN

• [▲,▼] to move cursor
• [OK] to set

```

You block and unblock programs by turning the V-Chip feature on or off in the *V-CHIP BLOCK* menu, and using the password you create. Be sure to remember your password.

By default, the software inside your TV is turned off, so if you don't want to use this feature, you don't need to do anything.

```

V-CHIP BLOCK
● MPAA
TV GUIDELINES
OPTION
SECRET No. 1234
STATUS:ON
RETURN

• [▲,▼] to move cursor
• [OK] to set

```

How V-Chip Works

When the V-Chip software is activated (or turned on), it reads a code that most broadcasters send with programs. That code tells the software the program's age-based rating (TV-MA, TV-14, etc.) and content themes [(Violence (V), Adult Language (L), etc.)]. If you have blocked the rating and/or content themes that the program contains, a message will appear and the channel won't be available for viewing.

Broadcasters aren't required to provide content themes, so programs that aren't tagged with a content themes can only be blocked if you block their age-based rating.

The TV age-based ratings and content themes and MPAA ratings are listed on the following pages.

```

PLEASE WAIT
NOW DOWNLOADING
V-CHIP OPTION DATA

```

New Rating Systems

The TV allows you to download additional new rating systems. If you watch a program with the new system, you can download the new V-Chip data for that program.



Using the TV's Features

Set the MPAA Rating Limits

The *MPAA* menu lets you decide which movies can and can't be viewed according to the age-based rating of the MPAA. The TV locks and unlocks the parental control settings using a password you select.

If you only want your child to watch movies that have a PG rating and lower (in other words, movies rated PG and G), then you could automatically block out all other movies with higher ratings.

```

MAIN MENU
TIMER
VIDEO ADJUST
COMPONENT ADJ.
AUDIO ADJUST
CLOSED CAPTION
● PARENT CONTROL
    
```

```

PARENT CONTROL
● V-CHIP BLOCK
RETURN
    
```

```

V-CHIP BLOCK
● MPAA
TV GUIDELINES
OPTION
SECRET No. 1234
STATUS: ON
RETURN

: [▲, ▼] to move cursor
: [OK] to set
    
```

```

MPAA :-----
● PG :BLOCK
PG-13 :BLOCK
R :BLOCK
NC-17 :BLOCK
X :BLOCK
RETURN

: [▲, ▼] to move cursor
: [◀, ▶] to set
    
```

1. Press MENU on the remote (the main *MENU* appears).
2. Press the up or down arrow until *PARENT CONTROL* is highlighted and press OK (the *PARENT CONTROL* menu appears with *V-CHIP BLOCK* highlighted).
3. Press OK (the *V-CHIP BLOCK* menu appears with *MPAA* highlighted). Press OK (the *MPAA* menu appears).

Note: Be sure to remember your number. If you have entered a number previously, enter that same number.

If you forget your secret number, press and hold the channel up and channel down buttons on the front of the TV simultaneously until the message *INPUT SECRET No.* disappears.

4. Use the up and down arrows to select the MPAA rating that you want to block.
5. Press the right or left arrow button to change the setting (the setting goes back and forth between *BLOCK* or not blocked — not blocked is shown on the screen as dashes - - - - -).

Note: All higher ratings and contents will be automatically blocked.

6. Press MENU to exit.

Rating	Description for MPAA Age-Based Ratings
X	An Older Rating. Encoded on older movies. Same as NC-17.
NC-17	No one 17 and under admitted.
R	Restricted. Under 17 requires accompanying parent or adult guardian.
PG-13	Parent Strongly Cautioned. Some material may be inappropriate for children under 13.
PG	Parental Guidance Suggested. Some material may not be suitable for children.
G	General Audience. All ages admitted.

Using the TV's Features

Age-Based Rating	Description and Content Themes for Age-Based Ratings (TV Guidelines)
TV-MA	Mature Audience Only. Specifically designed to be viewed by adults and may be unsuitable for children under 17. It contains one or more of the following content themes: crude indecent language (L), explicit sexual activity (S), or graphic violence (V).
TV-14	Parents Strongly Cautioned. Contains some material that many parents would find unsuitable for children under 14. Parents are strongly urged to exercise greater care in monitoring this program and are cautioned against letting children under the age of 14 watch unattended. This program contains one or more of the following content themes: intensely suggestive dialogue (D), strong coarse language (L), intense sexual situations (S), or intense violence (V).
TV-PG	Parental Guidance Suggested. Contains material that parents may find unsuitable for younger children. Many parents may want to watch it with their younger children. The program contains one or more of the following content themes: some suggestive dialogue (D), infrequent coarse language (L), some sexual situations (S), or moderate violence (V).
TV-G	General Audience. Most parents would find this program suitable for all ages. It contains little or no sexual dialogue (D) or situations (S), no strong language (L), and little or no violence (V).
TV-Y7	Directed to Children 7 years and older. Designed for children ages 7 and above. It may be more appropriate for children who have acquired the developmental skills needed to distinguish between make-believe and reality. Themes and elements in this program may include mild fantasy violence (FV) or comedic violence, or may frighten children under the age of 7.
TV-Y	All Children. Themes and elements in this program are designed for a young audience, including children from ages 2-6. It is not expected to frighten younger children.

Set the TV GUIDELINES Rating Limits

The *TV GUIDELINES* menu lets you decide which TV programs can and can't be viewed according to age and/or content. The TV locks and unlocks the parental controls settings using a password you select.

```

MAIN MENU
TIMER
VIDEO ADJUST
COMPONENT ADJ.
AUDIO ADJUST
CLOSED CAPTION
● PARENT CONTROL

PARENT CONTROL
● V-CHIP BLOCK
RETURN

V-CHIP BLOCK
MPAA
● TV GUIDELINES
OPTION
SECRET No. 1234
STATUS: ON
RETURN

: [←, →] to move cursor
: [↑, ↓] to set
    
```

1. Press MENU on the remote (the main *MENU* appears).
2. Press the up or down arrow until *PARENT CONTROL* is highlighted and press OK (the *PARENT CONTROL* menu appears with V-CHIP BLOCK highlighted).
3. Press OK (the *V-CHIP BLOCK* menu appears).
 Note: Be sure to remember your number. If you have entered a number previously, enter that same number.
 If you forget your password, press and hold the channel up and channel down buttons on the front of the TV simultaneously until the message *INPUT SECRET No.* disappears.
4. Press the down arrow button to highlight *TV GUIDELINES* and press OK (the *TV GUIDELINES* menu appears).

Using the TV's Features

```

AGE
TV-Y :-----
TV-Y7 :-----
●TV-G :BLOCK
TV-PG :BLOCK
TV-14 :BLOCK
TV-MA :BLOCK
CONTENT
RETURN

•[▲,▼] to move cursor
•[◀,▶] to set
    
```

5. Press OK (the TV Guidelines appear — the *AGE* menu). Press the up or down arrow buttons to highlight a TV rating.
 6. Press the right or left arrow button to change the setting (the setting goes back and forth between *BLOCK* or not blocked — not blocked is shown on the screen as dashes - - - - -).
- Note: All higher ratings and contents will be automatically blocked.
7. To exit, press the MENU button.

```

AGE
TV-Y :-----
TV-Y7 :-----
●TV-G :BLOCK
TV-PG :BLOCK
TV-14 :BLOCK
TV-MA :BLOCK
CONTENT
RETURN

•[▲,▼] to move cursor
•[◀,▶] to set
    
```

```

CONTENT
●D :BLOCK
L :BLOCK
S :BLOCK
V :BLOCK
FV :BLOCK
RETURN

•[▲,▼] to move cursor
•[◀,▶] to set
    
```

Note: The illustration below shows the *TV GUIDELINES* menu with the various fields described. To set Content rating limits, follow steps 1 -5 and highlight *Content* and press OK. Use the up and down arrow buttons to highlight different content categories (D, L, S, V, FV, TV-Y). Use the left or right arrow buttons to switch back and forth between *BLOCK* and not blocked — not blocked is shown on the screen as dashes (- - - - -).

Content Themes	
D	Sexually explicit dialogue
L	Adult language
S	Sexual situations
V	Violence
FV	Fantasy Violence
TV-Y	All Children

Rating Field

Lets you select from a list of age-based ratings you can block or view.

Rating Status Field

Shows you whether the status of the age-based rating limit to the left is blocked (*BLOCK*) or not blocked (- - - - -).

```

AGE
TV-Y :-----
TV-Y7 :-----
TV-G :-----
TV-PG :-----
●TV-14 :BLOCK
TV-MA :BLOCK
CONTENT
RETURN

•[▲,▼] to move cursor
•[◀,▶] to set
    
```



Using the TV's Features

```

MAIN MENU
TIMER
VIDEO ADJUST
COMPONENT ADJ.
AUDIO ADJUST
CLOSED CAPTION
● PARENT CONTROL

```

```

PARENT CONTROL
● V-CHIP BLOCK
RETURN

```

```

V-CHIP BLOCK
MPAA
TV GUIDELINES
● OPTION
SECRET No. 1234
STATUS: ON
RETURN

• [▲, ▼] to move cursor
• [OK] to set

```

```

OPTION

● DOWNLOAD: ON
RETURN

• [▲, ▼] to move cursor
• [◀, ▶] to set

```

```

PLEASE WAIT
NOW DOWNLOADING
V-CHIP OPTION DATA

```

```

INPUT SECRET No.

- - - -

```

```

INPUT SECRET No.

* * * *

• [0-9] to enter SECRET No.

```

Download New Rating System

You can choose to download additional new rating systems. The new rating systems will be automatically set according to the ratings you have previously chosen.

1. Press MENU on the remote (the main *MENU* appears).
2. Press the up or down arrow until *PARENT CONTROL* is highlighted and press OK (the *PARENT CONTROL* menu appears with V-CHIP BLOCK highlighted).
3. Press OK (the *V-CHIP BLOCK* menu appears).
4. Press the down arrow button to highlight *OPTION*, and press OK (the *OPTION* menu appears).

Note: Be sure to remember your number. If you have entered a number previously, enter that same number.

If you forget your secret number, press and hold the channel up and channel down buttons on the front of the TV simultaneously until the message *INPUT SECRET No.* disappears.

5. Since *DOWNLOAD* is highlighted, just press OK.
6. Press the left or right arrow button to change the setting back and forth from *OFF* to *ON*.

Note: If you watch a channel that uses the new system, *PLEASE WAIT NOW DOWNLOADING V-CHIP OPTION DATA* will appear.

7. To exit, press MENU.

Entering Your Secret Number

Your *Parent Controls* are password-protected. To create your password (secret number):

1. Follow Steps 1-3 above to display the *V-CHIP BLOCK* menu.
2. Use the down arrow button to select *SECRET No.* and press OK.
3. Use the number buttons on the remote to enter a password.

Note: Be sure to remember your number. If you have entered a number previously, enter that same number.

If you forget your secret number, press and hold the channel up and channel down buttons on the front of the TV simultaneously until the message *INPUT SECRET No.* disappears.



Using the TV's Features

```
MAIN MENU
TIMER
VIDEO ADJUST
COMPONENT ADJ.
AUDIO ADJUST
CLOSED CAPTION
● PARENT CONTROL
```

```
● PARENT CONTROL
● V-CHIP BLOCK
RETURN
```

```
V-CHIP BLOCK
MPAA
TV GUIDELINES
OPTION
SECRET No. 1234
● STATUS: ON
RETURN

• [▲, ▼] to move cursor
• [◀, ▶] to set
```

```
1 2
AIR
25
● SUB
V-CHIP HAS BEEN
ACTIVATED
THIS PROGRAM IS RATED TV-7
(WAIN PICTURE) FV
*PIP SCREEN IS DISABLED
• [MENU] to de-activate V-CHIP
• [CH +/-, 0-9] to exit
```

```
INPUT SECRET No.

- - - -

• [0-9] to enter SECRET No.
```

Turning V-Chip Block On and Off

If you don't turn on the V-Chip feature, none of the settings for V-Chip Rating Limits will take effect.

1. Press MENU on the remote (the main *MENU* appears).
2. Press the up or down arrow until *PARENT CONTROL* is highlighted and press OK (the *PARENT CONTROL* menu appears).
3. Press OK (the *V-CHIP BLOCK* menu appears).
4. Press the down arrow button to highlight *STATUS*.
5. Use the left or right arrow buttons to switch back and forth between *ON* and *OFF*. *INPUT SECRET No.* appears each time you want to change the status. Use the number buttons to enter your number.

- **STATUS ON** *V-CHIP HAS BEEN ACTIVATED* will appear when you tune to a channel with a rating you have blocked. When this message appears, press the MENU button and enter the secret number to temporarily cancel the V-Chip block.
- **STATUS OFF** No channels will be blocked.

6. To exit, press MENU.

Using the TV's Menu System

Chapter Overview:

- How to Use Your TV's Menu System
- The TIMER Menu
- The VIDEO ADJUST Menu
- The COMPONENT ADJUST Menu
- The AUDIO ADJUST Menu
- The LANGUAGE Menu
- The CLOSED CAPTION Menu
- The LANGUAGE Menu
- The ENERGY SAVE Menu
- Some of the SET UP Menu items

Changing Entertainment. Again.



Graphics contained within this publication are for representational purposes.

Using the TV's Menu System

How to Use Your TV's Menu System

The *V-CHIP BLOCK* menu was explained in Chapter 3, and most of the items in the *SET UP* menu were explained in Chapter 1. This Chapter explains the rest of the menu system. Use the buttons on the remote to access the menu system and make changes to the settings. To highlight or point to an item on the screen, press the arrow buttons on the remote (you'll notice the circle moves to indicate the item is highlighted). To select an item or activate a choice, press the OK button.

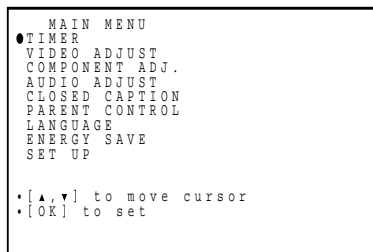

Accessing Menus

The first menu is called the *MAIN MENU*. To bring up the *MAIN MENU*, press MENU on the remote.

The choices in the main menu take you to a sub-menu or screen that enables you to change a setting. Press the up and down arrow buttons to highlight a choice, and press OK to select the choice that's highlighted. Some menus require you to press the left and/or right arrow buttons on the remote to change settings.

Tip

Feel free to explore the menu system. The up and down arrow buttons on the remote move the white circle to indicate that you've highlighted an item. The OK button is used to select a choice you've highlighted. To exit the menu system, press MENU.

Exiting from a menu

There are two ways to exit a menu:

- Press MENU on the remote.
- Highlight *RETURN* on the screen, and press the OK button.

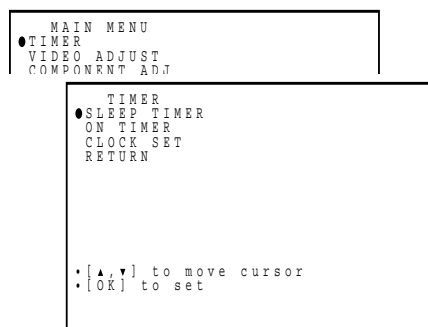

TIMER Menu

You must set the clock before you can use the *ON TIMER* or *SLEEP TIMER*.

CLOCK SET The TV has an automatic clock setting feature that automatically sets the time from an EDS (Extended Data Service) channel when the power is turned off. If there is no EDS channel or the signal is weak, the automatic clock setting may not function properly. You can turn off the automatic clock setting feature and enter the time and date manually.

ON TIMER Lets you set the timer to turn the TV on automatically. You can set it to wake you up in the morning or remind you that a favorite program is about to start.

SLEEP TIMER Lets you select the amount of time you want to give the TV before it shuts itself off.

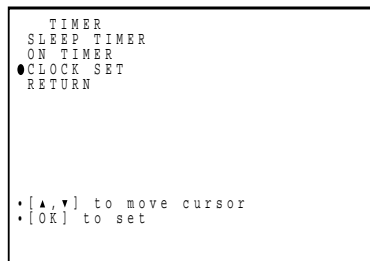

To set the *clock*.

1. From the MAIN MENU, select *TIMER*. Press the down arrow button to select *CLOCK SET* and press OK (the *CLOCK SET* screen appears).

Using the TV's Menu System

```
CLOCK SET
●AUTO CLOCK
  ON
EDS CH AUTO

CLOCK SET
  --:--
RETURN

•[▲,▼] to move cursor
•[◀,▶] to set
```

```
CLOCK SET
AUTO CLOCK
  OFF
EDS CH AUTO

●CLOCK SET
  --:--
RETURN

•[▲,▼] to move cursor
•[OK] to set
```

- **Automatic Clock Set** Press the up or down arrow to select *AUTO CLOCK ON* and press OK.

The indicator moves to *EDS CH*. If you know the EDS channel in your area, use the left and right arrows to enter the number or select *AUTO* and press OK.

Turn off the power. The clock is set automatically using the EDS signal. It may take a few hours to set the clock.

- **Manual Clock Set** Press the down arrow button to select *CLOCK SET* and press OK (the hour field starts flashing).

Press the left or right arrow button on the remote to set the hour. Press OK when finished (the minutes field starts flashing).

Press the left or right arrow button to set the minutes. Press OK when you're finished.

Note: Set the *AUTO CLOCK* to *OFF* when you're setting the clock manually.

3. Press MENU when you are finished.

To set the *ON TIMER* or *SLEEP TIMER*.

1. Display the *MAIN MENU* menu. Use the up or down arrow button on the remote to select *TIMER* and press the OK button (the *TIMER* menu appears).

```
TIMER
●SLEEP TIMER
ON TIMER
CLOCK SET
RETURN

•[▲,▼] to move cursor
•[OK] to set
```

2. Highlight *SLEEP TIMER* or *ON TIMER*.

- ***SLEEP TIMER*** Press the left or right arrow button to select the number of minutes (*30M*, *60M*, *90M*, or *120M*) you want the TV to remain on. The TV will automatically turn off after the amount of time you have selected.

To cancel the *SLEEP TIMER*, follow the steps described, but press the left or right arrow button on the remote until *---* *REMAIN* appears. You can also cancel the sleep timer by turning the TV off manually.

```
TIMER
SLEEP TIMER
●ON TIMER
CLOCK SET
RETURN

•[▲,▼] to move cursor
•[OK] to set
```

- ***ON TIMER*** When *ON TIMER* is highlighted on the *ON TIMER* menu screen, press the OK button (the hour field starts flashing). Press the left or right arrow buttons on the remote to select the hour, and press OK (the field for the minutes starts flashing). Press the left or right arrow button to set the minutes, and press OK.

Press the down arrow button to highlight *STATUS*, and press the left or right arrow button to change the setting to *ON*.

To turn off the *ON TIMER*, highlight *STATUS* and select *OFF*.

If there is no other operation, the TV will turn off automatically after two hours.

3. To exit, press MENU.

Using the TV's Menu System

VIDEO ADJUST Menu

The *VIDEO ADJUST* menu lets you adjust the way the picture looks on your TV. You also can reset all of the video features to the factory presets.

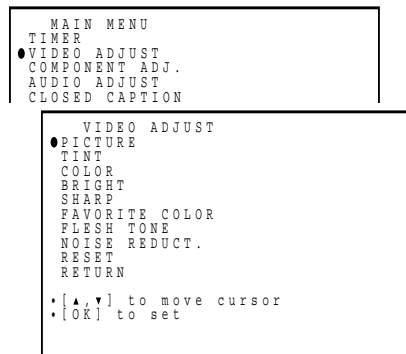

1. Press MENU (the *MAIN MENU* appears).
2. Press the arrow down button to highlight *VIDEO ADJUST*, and press OK (the following choices appear).
3. Highlight the item you want to adjust, and press OK. You'll use the left and right arrow buttons to make adjustments.

PICTURE Adjusts the difference between the light and dark areas of the picture.

TINT Adjusts the balance between the red and green levels.

COLOR Adjusts the intensity of the color.

BRIGHT Adjusts the brightness of the picture.

SHARP Adjusts the sharpness of the picture.

FAVORITE COLOR Adjusts the color temperature (balance between reddish whites and bluish whites).

FLESH TONE When it's turned *ON*, it adjusts skin tone to more natural colors.

NOISE REDUCTION When it's *ON*, reduces overall video "noise."

RESET All settings are changed to the presets used at the factory.

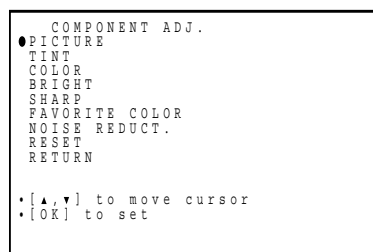

COMPONENT ADJUST Menu

Component video has better color resolution, purity, and resolution than the other video inputs. This feature is most evident with newer digital video equipment such as DVD Players.

Note: The *COMPONENT ADJ* menu is only available when you're playing video from the video connected to the TV's COMPONENT-IN jacks.

The items in the COMPONENT ADJ. menu are the same as those described in the *VIDEO ADJUST* menu (described previously), but you are adjusting the settings to be active only when the TV is playing content from the component connected to the COMPONENT IN jacks.



Using the TV's Menu System

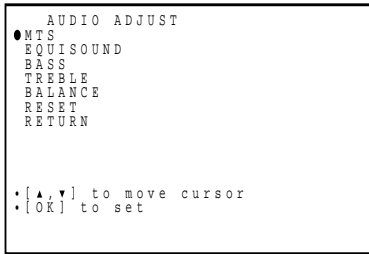

AUDIO ADJUST Menu

The *AUDIO ADJUST* menu lets you choose various settings for MTS (Multichannel TV Sound) and Equisound as well as adjust the bass, treble, and balance. You can also reset all of the audio features to the factory presets.

1. From the *MAIN MENU*, press the down arrow button to highlight the *AUDIO ADJUST* menu, and press OK (the *AUDIO ADJUST* menu appears).
2. Press the up or down arrow buttons to select the feature you want to adjust, and press OK.

Use the left or right arrow buttons to highlight a desired setting. Press the OK button to select the setting. The options and a brief description follows:

MTS (Multichannel TV Sound) This circuit allows reception of stereo or bilingual TV sound.

EQUISOUND This function keeps the volume level constant during program changes and commercial breaks.

2. If a slider appears for the feature, press the right or left arrow to adjust the slider and press OK.

BASS Increases or decreases the bass.

TREBLE Increases or decreases the treble.

BALANCE Press the right arrow to increase the right volume and the left arrow to increase the left volume.

Select RESET to have all audio adjustments reset to the factory settings.

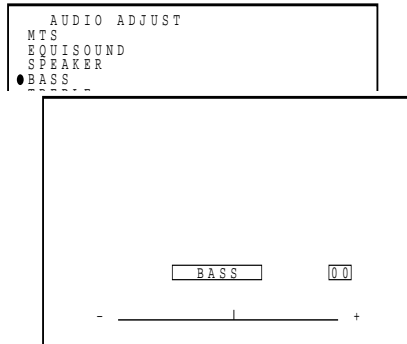

Using the TV's Menu System

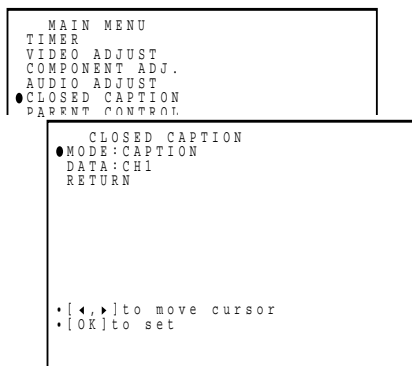

CLOSED CAPTION Menu

Closed captioning is not available on all channels at all times. Only specific programs encoded with closed-captioning information are applicable. Check your TV program listings for CC (closed caption) broadcasts.

The TV will automatically enter the closed caption mode when you press *MUTE* on the remote (or turn the volume all of the way down). Press MUTE again to remove the captions.

To set the *CLOSED CAPTION Mode*:

1. From the *MAIN MENU*, select *CLOSED CAPTION*. Press the up or down arrow buttons to select *MODE* or *DATA*.
2. If you select *MODE*, press the left or right arrow button to choose *CAPTION*, *TEXT*, or *OFF*.

Note: The *Text* modes cover nearly half of the picture on-screen to display the closed-captioned text. If no text is being broadcast, the screen may become dark and blank.

If you select *DATA*, press the left or right button to select *CH1* or *CH2*.

4. Press MENU to exit.

PARENT CONTROL — go to Chapter 3

LANGUAGE Menu

The language of the on-screen menus is set to English. If you want your TV/VCR's menus to appear in Spanish or French, follow these steps:

1. Press MENU on the remote (the MAIN MENU appears).
2. Press the up or down arrow button to highlight *LANGUAGE*, and press OK (the *LANGUAGE* menu appears).
3. Press the down arrow button on the remote to select *ESPAÑOL* (Spanish) or *FRANCAIS* (French).
4. Press OK (the on-screen menus appear in the language you selected).

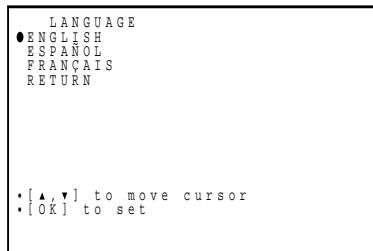

Using the TV's Menu System

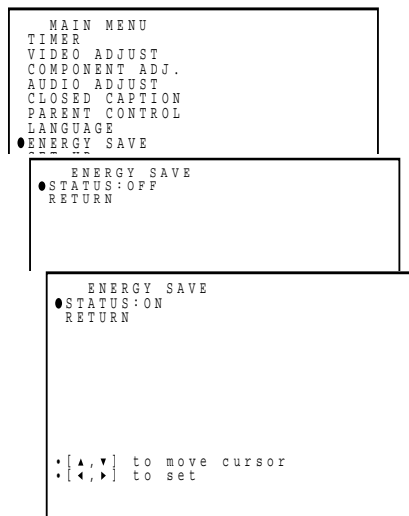

The ENERGY SAVE Menu

This feature reduces the brightness of the picture, lowering the power consumption of your TV/VCR by approximately 20 percent.

1. Press MENU on the remote (the main *MENU* appears).
2. Press the up or down arrow button to select *ENERGY SAVE* and press OK.
3. Press the left or right arrow button go back and forth between *ON* and *OFF*.
4. Press MENU to exit.

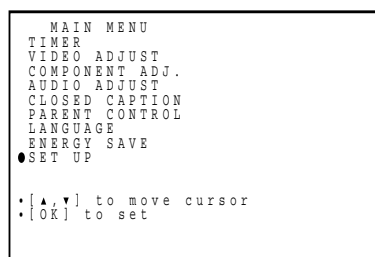

Additional Settings in the SETUP Menu

Most of the options in the *SETUP* menu were discussed in Chapter 1, but there are a few other settings within this menu that you can adjust to your personal preferences.

1. Press MENU on the remote (the main *MENU* appears).
2. Press the up or down arrow to select *SET UP* and press OK (the following choices appear):
 - **UNIVERSAL PLUS** This feature is sometimes called auto tuning. The auto-tuning feature automatically tunes the TV to the correct channel for different components you have connected to your TV (like a VCR or DVD Player, etc.).

When you set up auto tuning in the *Universal Plus* menu, you don't have to remember to change your TV to channel 3, for example, when you want to watch the tape that's in your VCR. To set up the *UNIVERSAL PLUS* menu:

1. Since *UNIVERSAL PLUS* is the first item, just press the OK button on the remote control (the *UNIVERSAL PLUS* menu appears).
2. If you've connected a VCR to your TV with audio/video cables (i.e., to a LINE IN jack on the TV), press INPUT until the corresponding video input channel appears — *LINE 1*, *LINE2*, *LINE3*, or *COMPONENT*. If you connected a VCR to your TV with a coaxial cable (i.e., to the ANT/CABLE jack on your TV), use the number buttons on your remote to enter the channel that corresponds to the switch on the back of your VCR (usually channel 3 or 4).
3. Press the down arrow button to highlight status. Press the left or right arrow button to switch between *ON* and *OFF*.
4. To exit, press MENU.

Continues on next page



Using the TV's Menu System

```

MAIN MENU
TIMER
VIDEO ADJUST
COMPONENT ADJ.
AUDIO ADJUST
CLOSED CAPTION
PARENT CONTROL
LANGUAGE
ENERGY SAVE
● SET UP

: [▲, ▼] to move cursor
: [OK] to set

```

- **BLUE SCREEN** This feature reduces the noise and mutes sound from channels with no signal or a weak signal.
 1. Press the up or down arrow to select **BLUE SCREEN** and press OK.
 2. Press the left or right arrow button to switch between **ON** and **OFF**.
 3. Press MENU to exit.
- **AUTO PRESET** Go to chapter 1.

```

SET AIR/CABLE
● ANT: AIR
NEXT

: [▲, ▼] to move cursor
: [OK] to set

```

- **CABLE** If you change the type of signal you use to get programming (i.e., you hook up cable and you used to rely on off-air signals to get programming), you'll need to change the setting in this menu.
 1. Press the up or down arrow to select **CABLE** and press OK.
 2. Press the left or right arrow button to highlight your choice (**AIR**, **CABLE**, **STD**, **CABLE HRC**, or **CABLE IRC**).
 3. To set, press OK.
 4. To exit, press MENU.

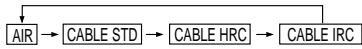

- **CH SEARCH** Go to chapter 1.
- **CH MEMORY** Go to chapter 1.
- **RETURN** Takes you to previous menu screen.



Other Information

Chapter Overview:

- Troubleshooting
- Care and Cleaning
- Front Panel
- Back Panel
- TV's Video Input Channel
- Limited Warranty
- Accessories
- Index

Changing Entertainment. Again.



Graphics used within this publication are for representation only.



Additional Information

Troubleshooting

Most problems you encounter with your TV you can correct by consulting the Troubleshooting list that follows.

General TV Problems

TV won't turn on

- Press the TV button.
- Something might be wrong with your remote control. Press the POWER button on the front of the TV. If the TV turns on with the POWER button, go to page 39 for remote control solutions.
- Make sure the TV is plugged in.
- Check the wall receptacle (or extension cord) to make sure it is "live" by plugging in something else.

Controls don't work

- If you're using the remote control, press the TV button first to make sure the remote is in TV mode.
- Unplug the TV for 10 minutes and then plug it back in. Turn the TV on, and try again.

TV turns off unexpectedly

- Sleep timer might have been activated. Go to page 31 for instructions.
- The TV turned on with the on timer. It will automatically turn off after two hours if no other control is used.
- Electronic protection circuit may have been activated because of a power surge. Wait 30 seconds and then turn the TV on again. If this happens frequently, the voltage in your house may be abnormally high or low.

TV turns on unexpectedly

- On timer (alarm) might have been activated. Go to page 31 for instructions.

Blank screen

- Try another channel.
- Check video adjustments. Go to page 32 for info about the *VIDEO ADJUST* menu.
- Make sure the line input isn't selected if you're trying to watch channels from off-air antenna or cable feed. Repeatedly press INPUT on the remote to switch between audio/video input jacks and the tuner.

No sound, picture okay

- Press the VOL UP button to increase the sound.
- Maybe sound is muted. Press the MUTE button to restore sound.

No picture, no sound but TV is on

- The channel might be empty — change channels.





Additional Information

Troubleshooting

Sound okay, picture poor

- Try adjusting sharpness function to improve weak signals. Go to page 32 for instructions.
- Check connections — make sure all cables are firmly inserted into the correct jacks.
- The *ENERGY SAVE* feature might be turned on. Go to page 36 for more information.

Can't select certain channel

- Channel may be blocked or not approved in the *V-CHIP BLOCK* menu.

Clock is wrong

- Power interruption. Need to reset the clock. Go to page 30 for more information.
- Clock was not set accurately (check AM/PM). Go to page 30 for more information.

Black box appears on the screen

- Closed-captioning text mode might be selected. Check the *CLOSED CAPTION* menu. Go to page 34 for more instructions.

Closed captions not appearing on screen

- Closed caption might not be turned on. Go to pages 34 for more information.
- Station might not be broadcasting closed captioning.

The Remote Control Doesn't Work

- Something might be between the remote and the remote sensor on the component. Make sure there is a clear path.
- Maybe the remote isn't aimed directly at the component (TV, VCR, etc.) that you're trying to operate.
- Maybe the remote isn't in TV mode — press the TV button.
- Maybe batteries in remote are weak, dead or installed incorrectly. Put new batteries in the remote.
- You might need to drain the remote's microprocessor: remove batteries and press the number 1 button for at least 60 seconds. Release the 1 button, replace the batteries, and (if necessary) program the remote again.

Problems with V-Chip/Parental Controls

The rating limits don't work

- You must turn V-Chip on. Go to the main *MENU* (press MENU on your remote), select *V-CHIP BLOCK*, and set *STATUS* to *ON*. Go to page 23 for instructions.

I don't remember my password and I want to unlock the TV

- If you forget your password, simultaneously press and hold the channel up and the channel down buttons on the front of the TV until *INPUT SECRET No.* disappears from the screen.





Additional Information

Front Panel (listed alphabetically)

If you misplace your remote control, you can use the buttons on the front of your TV to operate the TV. There are also a set of audio/video jacks on the front of the TV that are convenient for connecting a camcorder or video game device.

CH + and - Scans up and down through the current channel list.

INPUT Press to access the TV's video input channels that correspond with the jacks used to connect components.

POWER Button and Indicator Turns the TV on or off. The POWER indicator lights when the power is on.

Remote Sensor Receives signals from the remote. Aim remote at this sensor with no objects between them.

TIMER Indicator Lights when the Sleep Timer or Timer have been activated.

VOL + or - Increases and decreases the volume.

VIDEO, L/MONO, and R Input Jacks Receives audio and video signals from another component, like a video gaming device or camcorder when the component is connected to these jacks. To select these front panel jacks, press INPUT on the remote until *LINE 2* appears.

TV back panel

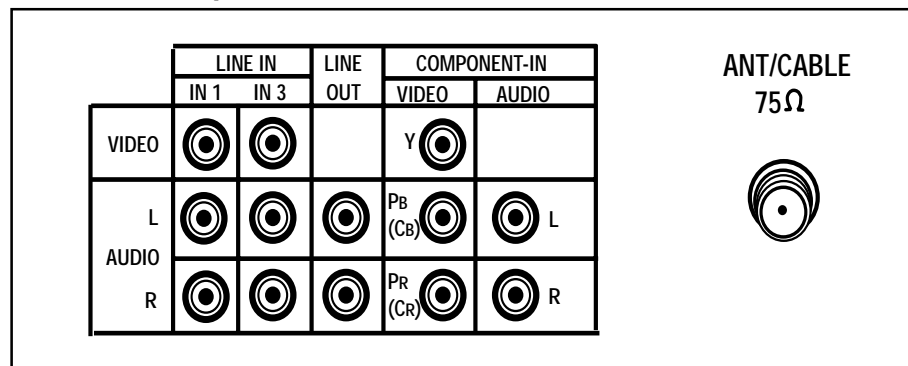

Back Panel (listed left to right)

LINE IN/IN1 and IN3 AUDIO (L and R) and VIDEO Jacks Receives signals from another component, such as a VCR or DVD Player, when the component is connected to these jacks. To see the content coming from the component connected to these jacks, press the INPUT button on the remote until *LINE 1* (or *LINE 3*) appears on the screen.

LINE OUT AUDIO (L and R) Jacks Sends audio signals from the TV to another component, like a stereo amplifier or speakers when the other component is connected to these jacks.

COMPONENT IN AUDIO (L and R) and VIDEO Y, P_B (C_B), and P_R (C_R) Jacks Receives signals from another component having COMPONENT jacks (like a DVD player) when the component is connected to these jacks. To see the content coming from the component connected to these jacks, press the INPUT button on the remote until *COMPONENT* appears on the screen.

ANT/CABLE Jack Receives a signal from an antenna or cable system when the TV is attached with an RF (coaxial) cable.





Additional Information

Limited Warranty

What your warranty covers:

- Defects in material or workmanship.

For how long after your purchase:

- One year from date of purchase for labor charges.
- One year from date of purchase for parts.
- Two years from date of purchase for picture tube.

The warranty period for rental units begins with the first rental or 45 days from date of shipment to the rental firm, whichever comes first.

What we will do:

- Pay any Authorized RCA Television Service Center the labor charges to repair your TV.
- Pay any Authorized RCA Television Service Center for the new or, at our option, refurbished replacement parts and picture tubes required to repair your TV.

How you get service:

- For 20" screen size: Take your RCA TV to any Authorized RCA Television Service Center and pickup when repairs are complete.
- For screen sizes larger than 20": Request home or pick up, repair and return service from any Authorized RCA Television Service Center, provided that your TV is located within the geographic territory covered by an Authorized RCA Television Service Center. If not, you must take your TV to the Service Center location at your own expense, or pay for the cost the Service Center may charge to transport your unit to and from your home.
- To identify your nearest Authorized RCA Service Center, ask your dealer, look in the Yellow Pages, or call 1-800-336-1900.
- Proof of purchase in the form of a bill of sale or receipted invoice which is evidence that the product is within the warranty period must be presented to obtain warranty service. For rental firms, proof of first rental is also required.

What your warranty does not cover:

- Customer instruction. (Your Owner's Manual clearly describes how to install, adjust, and operate your TV. Any additional information should be obtained from your dealer).
- Installation and related adjustments.
- Signal reception problems not caused by your TV.
- Damage from misuse or neglect.
- Cleaning of audio/video heads.
- Batteries.
- Customer replacement fuses.
- Images burned onto the screen.
- A TV that has been modified or incorporated into other products or is used for institutional or other commercial purposes.
- Acts of nature, such as but not limited to lightning damage.
- A TV purchased or serviced outside the U.S.A.





Additional Information

Product registration:

- Please complete and mail the Product Registration Card packed with your TV. It will make it easier to contact you should it ever be necessary. The return of the card is not required for warranty coverage.

Limitation of Warranty:

- **THE WARRANTY STATED ABOVE IS THE ONLY WARRANTY APPLICABLE TO THIS PRODUCT. ALL OTHER WARRANTIES, EXPRESS OR IMPLIED (INCLUDING ALL IMPLIED WARRANTIES OF MERCHANTABILITY OR FITNESS FOR A PARTICULAR PURPOSE) ARE HEREBY DISCLAIMED. NO VERBAL OR WRITTEN INFORMATION GIVEN BY THOMSON MULTIMEDIA INC., ITS AGENTS OR EMPLOYEES SHALL CREATE A WARRANTY OR IN ANY WAY INCREASE THE SCOPE OF THIS WARRANTY.**
- **REPAIR OR REPLACEMENT AS PROVIDED UNDER THIS WARRANTY IS THE EXCLUSIVE REMEDY OF THE CONSUMER. THOMSON MULTIMEDIA INC. SHALL NOT BE LIABLE FOR INCIDENTAL OR CONSEQUENTIAL DAMAGES RESULTING FROM THE USE OF THIS PRODUCT OR ARISING OUT OF ANY BREACH OF ANY EXPRESS OR IMPLIED WARRANTY ON THIS PRODUCT. THIS DISCLAIMER OF WARRANTIES AND LIMITED WARRANTY ARE GOVERNED BY THE LAWS OF THE STATE OF INDIANA. EXCEPT TO THE EXTENT PROHIBITED BY APPLICABLE LAW, ANY IMPLIED WARRANTY OF MERCHANTABILITY OR FITNESS FOR A PARTICULAR PURPOSE ON THIS PRODUCT IS LIMITED TO THE APPLICABLE WARRANTY PERIOD SET FORTH ABOVE.**

How state law relates to this warranty:

- Some states do not allow the exclusion nor limitation of incidental or consequential damages, or limitations on how long an implied warranty lasts, so the above limitations or exclusions may not apply to you.
- This warranty gives you specific legal rights, and you also may have other rights that vary from state to state.

If you purchased your product outside the United States:

- This warranty does not apply. Contact your dealer for warranty information.

Service calls which do not involve defective materials or workmanship are not covered by this warranty. Costs of such service calls are the sole responsibility of the purchaser.





Additional Information

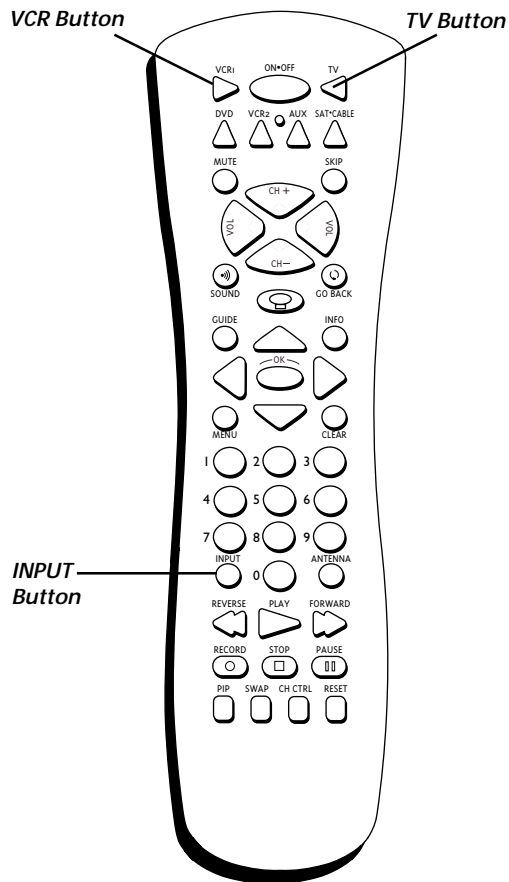

Finding the TV's Video Line Input Channel

You need to tune your TV to the video line input channel if you're using the Audio/Video (A/V) IN jacks to connect to the other components (such as a cable box, a VCR, satellite receiver, or DVD player).

You must select the TV's video line input channel before you can see the video and hear the audio from another component you have connected to these jacks.

To access the video line input channel:

- Press the TV button on the remote.
- Press INPUT to select *LINE 1* for the LINE IN/IN1 input jacks on the back of the TV.
- Press INPUT again to select *LINE 2* for the VIDEO, L/MONO, and R input jacks on the front of the TV.
- Press INPUT a third time to select *LINE 3* for the VIDEO, L/MONO, and R input jacks on the front of the TV.
- Press INPUT a fourth time to select *COMPONENT* for the COMPONENT-IN input jacks on the back of the TV.

Care and Cleaning

CAUTION: Turn OFF your TV before cleaning.

You can clean the TV as required, using a soft lint-free cloth. Be sure to occasionally dust the ventilation slots in the cabinet to help assure adequate ventilation.

The TV screen may be cleaned with a soft, lint-free cloth as well. Take care not to scratch or mar the screen. If necessary, you may use a cloth dampened with warm water.

Never use strong cleaning agents, such as ammonia-based cleaners, or abrasive powder. These types of cleaners will damage the TV.

While cleaning, do not spray liquid directly on the screen or allow liquid to run down the screen and inside the TV. Also, avoid placing drinks or vases with water on top of the TV. This could increase the risk of fire or shock hazard or damage to the TV.

Caution: If fixed (non-moving) images are left on the screen for long periods, they may be permanently imprinted on the picture tube. Such images include network logos, phone numbers, and video games. This damage is not covered by your warranty. Extended viewing of channels displaying these images should be avoided.





Additional Information

(This page intentionally left blank.)





Additional Information

Accessories

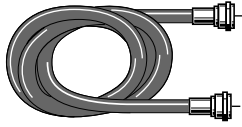

VH81 (3-ft)

VH82 (6-ft)

Screw-on Cable attaches to the round antenna connectors (called 75-ohm F-type) on the back of your TV. The ends screw onto the connectors for a secure connection.

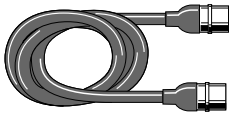

VH89 (6-ft)

Push-on Cable attaches to the round antenna connectors (called 75-ohm F-type) on the back of your TV. Ends push on for a quick connection.

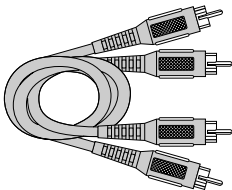

Gold-Tipped cable

VH83 (6-ft)

Monaural VCR Dubbing Cable Double cable that lets you connect the video and audio jacks of two VHS VCRs to duplicate tapes. Can also be used to connect a VCR to your TV. Cable is color-coded and shielded. Has RCA-type phono plugs on each end.

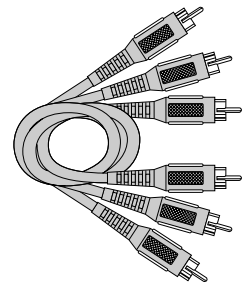

Gold-Tipped cable

VH84 (6-ft)

Stereo VCR Dubbing Cable Triple cable that lets you connect the video and left and right audio jacks of stereo components.

Accessory Order Form

Description	Part No.	Price	Qty
Screw-on antenna cable (3-ft)	VH81	\$3.95	
Screw-on antenna cable (6-ft)	VH82	\$4.95	
Push-on antenna cable (6-ft)	VH89	\$5.95	
Monaural VCR Dubbing Cable (6-ft)	VH83	\$5.95	
Stereo VCR Dubbing Cable (6-ft)	VH84	\$9.95	
2-way Signal Splitter	VH47	\$3.95	
Antenna Mixer (not shown)	193984	\$11.15	
Remote Control (CRK76TSL1)	254494	\$49.95	
Audio•Video Adapter (not shown)	228449	\$4.45	

Prices are subject to change without notice.

Total Merchandise \$ _____

Sales Tax \$ _____

We are required by law to collect the appropriate sales tax for each individual state, country, and locality to which the merchandise is being sent.

Shipping and Handling \$ 5.00

Total Amount Enclosed \$ _____

Use VISA, MasterCard, or Discover Card preferably.

Money order or check must be in U.S. currency only.

No COD or CASH.



Detach Here

All accessories are subject to availability. Where applicable, we will ship a superseding model.

Please complete other side also



Continued on next page.....





Charge your order on your VISA, MasterCard, or Discover Card by filling in below

USE YOUR CREDIT CARD

IMPORTANT: Copy complete account number from your VISA card



My card expires:

IMPORTANT: Copy complete account number from your MasterCard



Copy Number above your name on MasterCard: My card expires:

IMPORTANT: Copy complete account number from your Discover Card



My card expires:

AUTHORIZED SIGNATURE
(Credit card order will not be processed without signature)

Print or type your name and address clearly.

A complete and correct order will save you days of waiting.

Name: _____

Street: _____

_____ Apt: _____

City: _____

State: _____ Zip: _____

Daytime phone number: _____

Please make sure that both sides of this form have been filled out completely.

- Allow 4 weeks for delivery.
- All accessories are subject to availability.
- Prices are subject to change.

Detach Here 

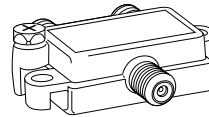

Splitter VH47

2-way Signal Splitter

Helps you connect a second TV or VCR.

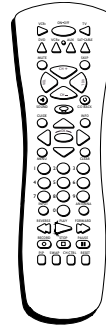

CRK76TSL1

Remote Control

This is the remote control that came packed with your TV. Replacements or spares can be ordered as needed.

To Order

To place your order by phone, have your Visa, MasterCard or Discover Card ready and call the toll-free number listed below.

Use this number only to place an order for accessory items listed on this order form.

1-800-338-0376

To place your order by mail, detach and mail the completed order form with credit card information, money order or check in US currency (made payable to Thomson multimedia Inc.) to the following address:

**Video Accessories
PO Box 8419
Ronks, PA 17573**





This page intentionally left blank





Additional Information

A

Accessories, ordering 45
Add/erase channels 14
Age-Based Ratings 25
ANT/CABLE jack 40
Arrow buttons 16, 24, 33, 34, 35
AUDIO ADJUST menu 33
AUDIO IN jacks 11
Audio/video jacks 40, 43
Auto channel search 13
AUX button 16

B

Back panel jacks 40
Back-lit remote 16
Batteries for remote 12
BLUE SCREEN feature 36

C

Cable Box, code list 20
CH buttons 16, 40
CH MEMORY menu 14
Channels, add or erase 14
CLEAR button 16, 17
Clock setting, automatic and manual 31
CLOSED CAPTION menu 34
Code list
 Cable Box 20
 Satellite Receiver 20
 VCR 20
COMPONENT jacks 40
Connections 6, 7, 8, 9, 11
Controls
 back of TV 40
 front of TV 40

D

DVD button 16
DVD, connecting 9

F

Fixed images 43
FORWARD button 16
Front panel controls 40

I

INFO button 16
Initial setup 13
INPUT button 17, 43

L

Language, select 13
Light button 16

Limited Warranty 41

M

Main MENU 14, 24, 25, 27, 28, 30
MENU button 14, 17, 24, 25, 27, 28, 30, 34, 35, 36
Menu system 30
MPAA menu 23, 24
MUTE button 17

N

New rating system 23, 27
Number buttons 16

O

OK button 13, 34
ON TIMER feature 31
ON•OFF button 17

P

Parental controls 23
Password 27
PAUSE button 17
PIP
 buttons 22
 feature 22
PLAY button 17
POWER button 12, 40
POWER indicator 12, 40
Programming the remote 18

R

Remote
 batteries 12
 sensor 40
Remote control
 buttons 16
 programming 18
Reset audio 33
REVERSE button 17

S

SAT•CABLE button 17
Satellite receiver
 code list 20
 connecting 11
Secret number 27
Sensor, remote 40
Setup, initial 13
SKIP button 17
SLEEP TIMER feature 31
SOUND button 17
Stand and base safety information 6
STOP button 17





Additional Information

T

- Table of contents 3
- TIME menu 30
- TIMER button 17
- Troubleshooting 38
- TV button 17, 43
- TV GUIDELINES menu 23, 25

V

- V-Chip 23
 - chart for age-based ratings 25
 - chart for content themes 26
 - chart for MPAA ratings 24
 - download new rating system 23, 27
 - secret number 27
 - set MPAA rating limits 24
 - set TV GUIDELINES rating limits 25
 - turning on and off 28
- V-CHIP BLOCK menu 23
- VCR
 - code list 20
 - connecting 8, 9, 11
- VIDEO ADJUST menu 32
- VIDEO IN jack 11
- Video input channel 43
- VOL buttons 17, 40

W

- Warranty 41



Visit the RCA website at www.rca.com

Please do not send any products to the Indianapolis address listed in this manual or on the carton. This will only add delays in service for your product.

Thomson multimedia Inc.
10330 North Meridian Street
Indianapolis, IN 46290

©2001 Thomson multimedia Inc.
Trademark(s)® Registered
Marca(s) Registrada(s)
Printed in Malaysia
TOCOM 15775930

THOMSON

THOMSON 