

RCA

Television User's Guide

Changing Entertainment. Again.



Important Information

WARNING

To reduce the risk of fire or electric shock, do not expose this product to rain or moisture.

CAUTION

RISK OF ELECTRIC SHOCK
DO NOT OPEN

Caution: To reduce the risk of electric shock, do not remove cover (or back). No user serviceable parts inside. Refer servicing to qualified service personnel.



This symbol indicates "dangerous voltage" inside the product that presents a risk of electric shock or personal injury.



This symbol indicates important instructions accompanying the product.

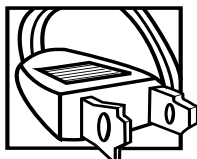

Caution: To prevent electric shock, match wide blade of plug to wide slot, fully insert.

Attention: Pour éviter les chocs électriques, introduire la lame la plus large de la fiche dans la borne correspondante de la prise et pousser jusqu'au fond.

Refer to the identification/rating label located on the back panel of your product for its proper operating voltage.

FCC Regulations state that unauthorized changes or modifications to this equipment may void the user's authority to operate it.

Caution: Using video games or any external accessory with fixed images for extended periods of time can cause them to be permanently imprinted on the picture tube (or projection TV picture tubes). ALSO, some network/program logos, phone numbers, etc. may cause similar damage. This damage is not covered by your warranty.

Cable TV Installer: This reminder is provided to call your attention to Article 820-40 of the National Electrical Code (Section 54 of the Canadian Electrical Code, Part 1) which provides guidelines for proper grounding and, in particular, specifies that the cable ground shall be connected to the grounding system of the building as close to the point of cable entry as practical.

Product Registration

Please fill out the product registration card (packed separately) and return it immediately. Returning the card allows us to contact you if needed.

Product Information

Keep your sales receipt to obtain warranty parts and service and for proof of purchase. Attach it here and record the serial and model numbers in case you need them. These numbers are located on the product.

Model No. _____

Serial No. _____

Purchase Date: _____

Dealer/Address/Phone: _____

Chapter 1: Connections & Setup

| | |
|--|-----------|
| Things to Consider Before You Connect | 4 |
| Protect Against Power Surges | 4 |
| Protect Components from Overheating | 4 |
| Position Cables Properly to Avoid Audio Interference | 4 |
| Important Stand and Base Safety Information | 4 |
| Use Indirect Light | 4 |
| Choose Your Connection | 5 |
| TV + VCR | 6 |
| TV Only | 7 |
| TV + VCR + Satellite Receiver | 9 |
| The Front of Your TV | 10 |
| Plug in the TV | 11 |
| Put Batteries in the Remote | 11 |
| How to Use the Remote Control to Complete the Interactive Setup | 11 |
| Turn on the TV | 11 |
| Complete the Interactive Setup | 12 |
| Set the Menu Language | 12 |
| Complete Auto Channel Search | 12 |

Chapter 2: Using the TV's Features

| | |
|---|-----------|
| The Buttons on the Remote Control | 14 |
| Programming the Remote to Operate Other Components | 16 |
| Find Out If You Need to Program the Remote | 16 |
| How to Program the Remote | 16 |
| How to Use the Remote After You've Programmed it | 17 |
| Code List | 18 |

Chapter 3: Using the TV's Features

| | |
|--|-----------|
| Channel Banner | 20 |
| Parental Controls and V-Chip | 21 |
| Important Note About Parental Controls | 21 |
| How V-Chip Works | 22 |
| V-Chip TV Rating Limit | 23 |
| Blocking Specific Content Themes | 25 |
| Viewing Specific Content Themes | 25 |
| V-Chip Movie Rating Limit | 26 |
| V-Chip Unrated Program Block | 27 |
| Channel Block | 27 |
| Front Panel Block | 28 |
| Lock/Unlock Parental Controls | 28 |

Table of Contents

Chapter 4: Using the Menu System

| | |
|---|-----------|
| How to Use the Different Types of Menus and Control Panels | 30 |
| Menus | 30 |
| Control Panels | 30 |
| Audio Menu | 32 |
| Picture Quality Menu | 33 |
| Screen Menu | 33 |
| Using Closed Captioning | 34 |
| Closed-Caption Modes | 34 |
| Channel Menu | 35 |
| Time Menu | 35 |

Chapter 5: Other Information

| | |
|--------------------------------|-----------|
| Troubleshooting | 38 |
| Care and Cleaning | 39 |
| Limited Warranty | 40 |
| Index | 42 |

Connections & Setup

Chapter Overview:

- Things to Consider Before You Connect
- Choose Your Connection
- Connections
- The Front of Your TV
- Plug in the TV
- Put Batteries in the Remote
- How to Use the Remote Control to Complete the Interactive Setup
- Turn on the TV
- Complete the Interactive Setup

Changing Entertainment. Again.



Things to Consider Before You Connect

Protect Against Power Surges

- Connect all components before you plug any of their power cords into the wall outlet.
- Turn off the TV and/or component before you connect or disconnect any cables.
- Make sure all antennas and cables are properly grounded. Refer to the Important Safeguards sheet packed with your TV.

Protect Components from Overheating

- Don't block ventilation holes on any of the components. Arrange the components so that air can circulate freely.
- Don't stack components.
- When you place components in a stand, make sure you allow adequate ventilation.
- If you connect an audio receiver or amplifier, place it on the top shelf so the heated air from it won't flow around other components.

Position Cables Properly to Avoid Audio Interference

- Insert each cable firmly into the designated jack.
- If you place components above the TV, route all cables down the side of the back of the TV instead of straight down the middle of the back of the TV.
- If your antenna uses 300-ohm twin lead cables, do not coil the cables. Also, keep the twin lead cables away from audio/video cables.

Important Stand and Base Safety Information



Choose the location for your TV carefully. Place the TV on a stand or base that is of adequate size and strength to prevent the TV from being accidentally tipped over, pushed off, or pulled off. This could cause personal injury and/or damage the TV. Refer to the Important Safeguards sheet packed with your TV.

Use Indirect Light

Don't place the TV where sunlight or room lighting will be directed toward the screen. Use soft or indirect lighting.

Choose Your Connection

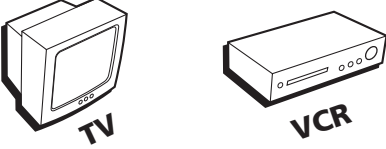
There are several ways to connect your TV. Please use the following chart to determine which connection is best for you. Proceed to the appropriate page and connect your TV.

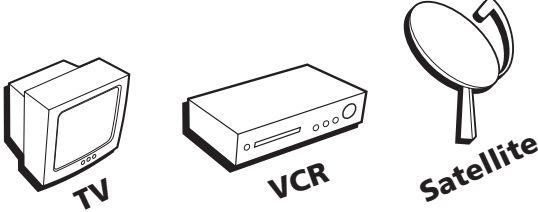
| Components | Cables Needed | Connection Title | Go to... |
|---|---------------|----------------------------------|-----------|
|  | 1 Coaxial | TV + VCR | page 6 |
|  | 2 Coaxial | TV Only | page 7 |
|  | 4 Coaxial | TV + VCR + Satellite Receiver | pages 8-9 |

Cables Needed to Connect Components to Your TV

You will need coaxial cables for the connections represented in this book.

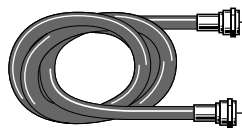

Coaxial cable

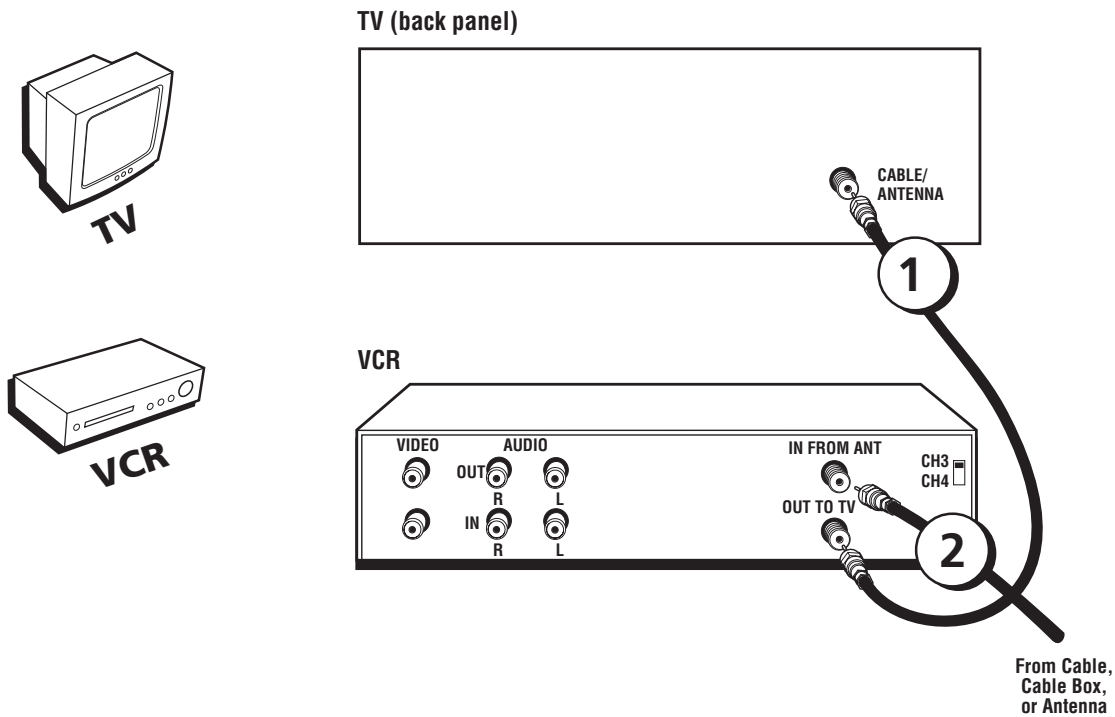

TV + VCR

1. Connect your TV to your VCR

Connect a coaxial cable to the CABLE/ANTENNA jack on your TV and to the Output Jack on your VCR (sometimes labeled OUT TO TV).

2. Connect cable or antenna to your VCR

Connect the coaxial cable from your cable outlet, cable box, or antenna to the Input Jack on your VCR (sometimes labeled IN FROM ANTENNA or IN FROM ANT).

Go to page 11

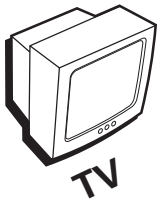

TV (back panel)

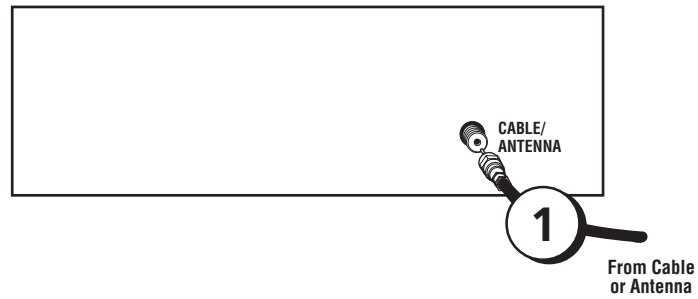

TV Only

1. Connect the TV to your cable or antenna

Connect the coaxial cable from your cable or antenna to the CABLE/ANTENNA jack on the back of your TV.

Go to page 11

Connections & Setup

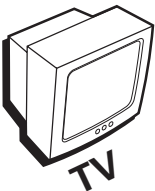
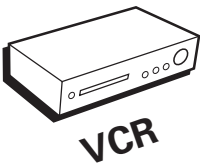

SATELLITE RECEIVER

From Cable or Antenna

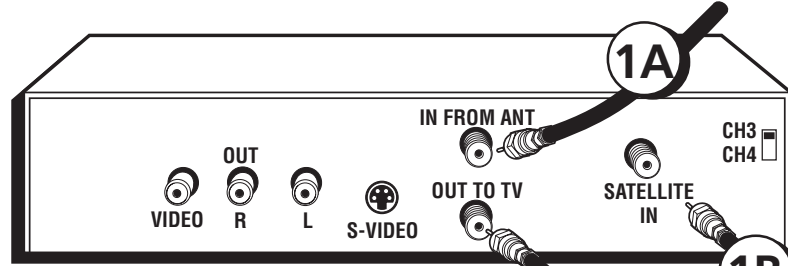

VCR

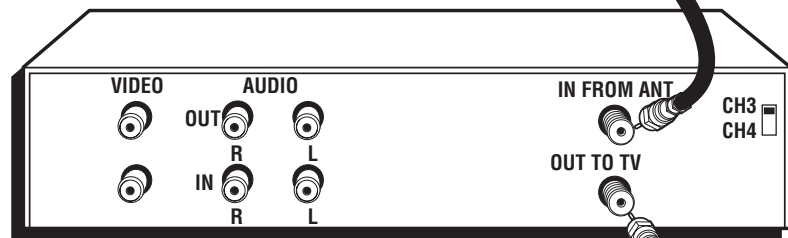

Satellite Signal

TV (back panel)

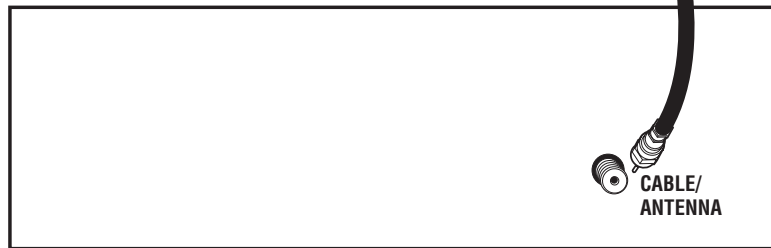

TV + VCR + Satellite Receiver

1. Connect coaxial cables to the Satellite Receiver

- A. Connect the coaxial cable from your cable outlet, cable box, or antenna to the Input Jack on your satellite receiver (sometimes labeled IN FROM ANT).
- B. Connect the coaxial cable from your satellite dish antenna to the Input Jack on your satellite receiver (sometimes labeled SATELLITE IN).

2. Connect the Satellite Receiver to the VCR and to the TV

- A. Connect a coaxial cable to the Output Jack (sometimes labeled OUT TO TV) on the satellite receiver and to the Input Jack on the VCR (sometimes labeled IN FROM ANT).
- B. Connect a coaxial cable to the Output Jack on the VCR (sometimes labeled OUT TO TV) and to the CABLE/ANTENNA jack on the TV.

Go to page 11

The Front of Your TV

Front Panel

If you cannot locate your remote you can use the buttons of your TV to operate many of the TV's features.

MENU Brings up the Main menu. When in the menu system, it selects highlighted items. Also returns you to the previous menu.

CH v Scans down through the current channel list. When you're using the TV's menu system, used as a down arrow.

CH ^ Scans up through the channel list. When you're using the TV's menu system, used as an up arrow.

VOL - Decreases the volume. When you're using the TV's menu system, used as a left arrow.

VOL + Increases the volume. When you're using the TV's menu system, used as a right arrow.

POWER Turns the TV on and off.

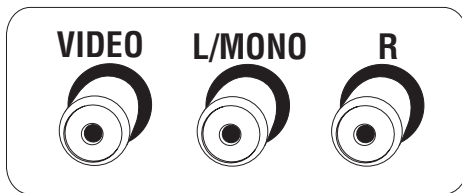

Front Panel Jacks

You can access the component you connected to the front of the TV by pressing the INPUT button on your remote.

VIDEO (in) Receives video from another component such as a VCR, camcorder or video game console.

L/MONO and R (audio) Receives audio from another component such as a VCR, camcorder or video game console.

Plug in the TV

Plug the end of the power cord into the wall outlet. Match the wide blade of the plug with the wide slot in the outlet. Insert the plug completely into the outlet.

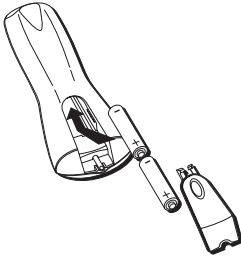

Put Batteries in the Remote

1. Remove the battery compartment cover on the remote.
2. Insert new batteries. Match the polarities (+ and -) on the batteries with the diagram on the remote.
3. Put the battery compartment cover back on the remote.

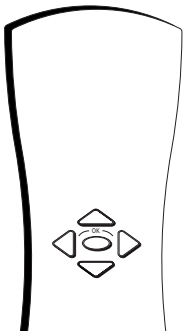

Use the CHAN \wedge/\vee and VOL $+/-$ buttons to move through the menu system. Use the MENU button to select items.

How to Use the Remote Control to Complete the Interactive Setup

The technical term is “Navigation” – how you move through the on-screen menus. The theory is the same throughout the menu screens: highlight your choice and select it.

To highlight a menu item, use the CHAN \wedge/\vee buttons to move up or down. Use the VOL $+/-$ buttons to move left or right or to change an item’s setting.

Use the MENU button to select menu items.

You can also use the remote’s number buttons to select menu items directly.

Note: Highlighted means that the menu item stands out from other menu items on the list (appears darker, brighter, or a different color).

Turn on the TV

Press the TV button on the remote control or the POWER button on the front of the TV (the first screen of the Interactive Setup appears). The menu screens “time out” after a period of time if you don’t make a selection. The tips in this section tell you how to access the Setup menu screens manually.

Tip

To access the setup menus manually, press **MENU** and choose **Setup**.

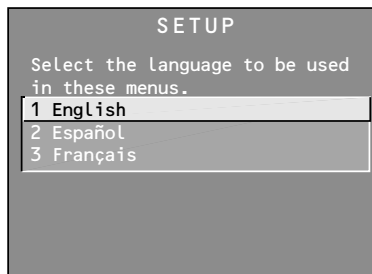

Complete the Interactive Setup

The menu system in your TV allows the TV's features to work properly. In this book, we call it the “interactive setup” because the TV asks you questions, you answer, and the TV makes the appropriate adjustments. The first time you turn on your TV, the setup screens appear automatically.

Set the Menu Language

The first part of the *SETUP* asks you to select your preferred language for the menu system.

1. Highlight your preferred language for the menu system.
2. Press **MENU** to select that language.

Complete Auto Channel Search

The next part of the *SETUP* asks you if you want the TV to search for all channels viewable through your antenna or cable TV system. This is sometimes called “auto programming.”

1. Press **MENU** to tell the TV to begin searching for channels. A progress report appears on the screen.
2. When the screen on the TV tells you the search is complete, press **MENU**.

Note: If you skip Auto Channel Search now, you can access it later through the Channel menu. See *Chapter 4* for more details.

Using the Remote Control

Chapter Overview:

- The Buttons on the Remote Control
- Programming the Remote to Operate Other Components
- How To Use the Remote After You've Programmed It
- Code List

Changing Entertainment. Again.



Using the Remote Control

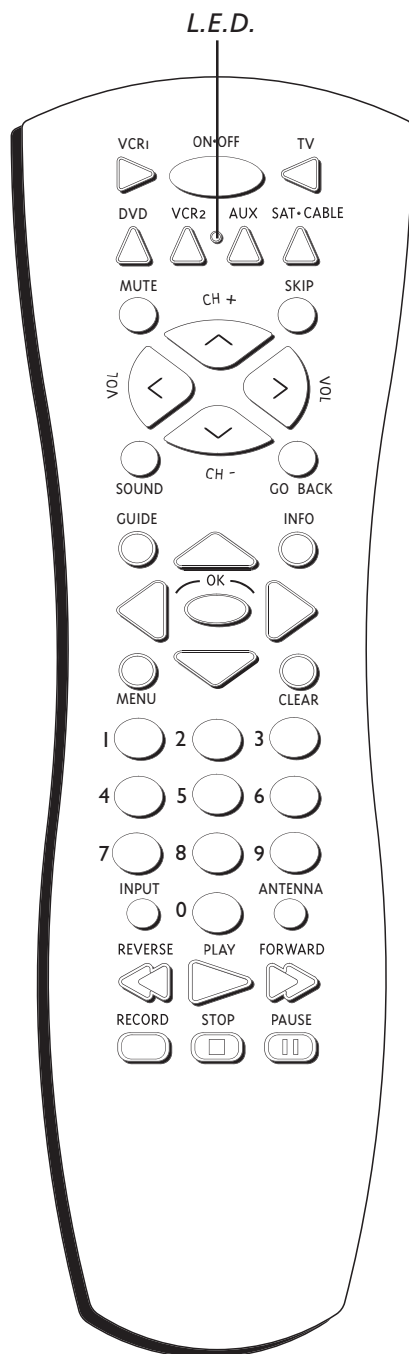

The Buttons on the Remote Control

0-9 (Number buttons) Enter channel numbers and time settings directly through the remote control.

Arrow buttons (up, down, left, right) Press the arrow buttons to move through the on-screen menu system.

ANTENNA Functions as TV/VCR button in VCR mode and TV/receiver button in SAT•CABLE mode.

AUX (auxiliary) Puts the remote in auxiliary mode to operate the component you've programmed the remote to operate with this button. You can program this button to control a cable box, satellite receiver, Dimensia audio components, some RCA audio components, a laserdisc player, or a VCR.

CH+ and CH- buttons Scan up or down through the current channel list. Press once to change the channel up or down; press and hold to continue changing channels.

CLEAR Removes any menu or display from the screen and returns you to TV viewing.

DVD Puts the remote in DVD mode to operate RCA, GE and Proscan DVD players. It cannot be programmed.

FORWARD If you're operating a VCR or DVD player with the remote control, press FORWARD to advance a disc or videotape.

GO BACK Returns you to the previous channel.

GUIDE Used with compatible components that have the capability of receiving the on-screen guide.

INFO Displays channel information.

INPUT In TV mode, press INPUT to toggle through the available Video Input channels. In SAT mode, press to select available channel lists for RCA satellite receivers.

L.E.D. (light-emitting diode) The little light on the remote that lights when you are programming the remote. It also lights when you press a valid button on the remote.

MENU Displays the TV's main menu and selects highlighted items.

MUTE Lowers the volume to its minimum level. Press again to restore volume.

OK Selects items in the TV's menu system. If you're operating another component, the OK button might allow you to select a highlighted item in the on-screen menu.

ON•OFF Turns the TV on and off. When the remote is in another mode (VCR, DVD, Satellite, etc.) and the remote is programmed to operate that component, you can press ON•OFF to turn the component on and off.

PAUSE If you're operating a VCR or DVD player with the remote control, press PAUSE when the disc or videotape is playing to pause playback.

Using the Remote Control

Tip

To turn off all the RCA, GE, and PROSCAN components that are connected to the TV, press ON•OFF twice within two seconds.

This feature only works with most RCA, GE and PROSCAN products.

PLAY If you're operating a VCR or DVD player, plays the disc or videotape.

RECORD If the remote is in VCR mode, press RECORD to start recording.

REVERSE If you're operating a VCR or DVD player with the remote control, press REVERSE to go backwards on a disc or videotape.

SAT•CABLE Puts the remote in SAT•CABLE mode.

SKIP If you press this button before you change the channel, the TV waits 30 seconds and automatically goes back to the original channel. Each time you press SKIP, you add 30 seconds (i.e, if you press SKIP two times before you change the channel, the TV waits 60 seconds and automatically turns back to the original channel).

SOUND Toggles between the available sound modes for compatible TVs.

STOP If you're operating a VCR or DVD player, stops playing the disc or videotape.

TV Turns on the TV and puts the remote in TV mode. Also displays channel information.

VCR1 Puts the remote in VCR1 mode.

VCR2 Puts the remote in VCR2 mode.

VOL (up and down) buttons Decrease or increase the TV's volume.

Using the Remote Control

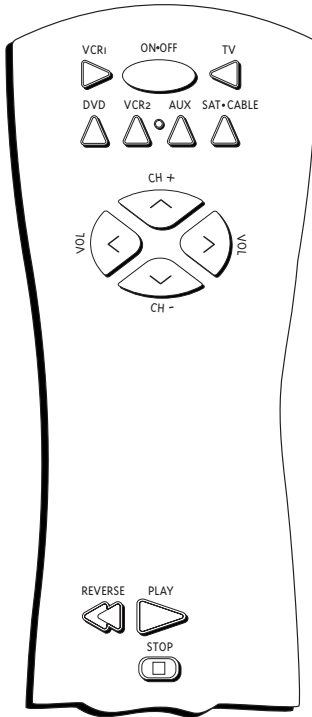

You'll use these buttons when you program the remote to operate another component.

The remote may not operate all models of all brands.

Tip

To stop the automatic code search without programming any components, press and hold CLEAR until the light on the remote turns off.

Programming the Remote to Operate Other Components

The universal remote control can be programmed to operate most brands of remote controllable VCRs, satellite receivers and cable boxes. The remote is already programmed to operate most RCA, GE and Proscan TVs, VCRs, DVD players, laserdisc players and satellite receivers.

Find Out If You Need to Program the Remote

To determine whether the universal remote needs to be programmed, turn a component ON, such as a VCR, point the remote at the VCR, and press the VCR1 button. Then press ON•OFF or channel up or channel down to see if the VCR responds to the remote commands. If not, the remote needs to be programmed.

Note: The DVD button cannot be programmed. It can be used to operate RCA, GE and Proscan DVD players only.

How to Program the Remote

There are two ways to program the remote control: automatic code search and direct entry. Instructions for both ways follow.

Using Automatic Code Search

1. Turn on the component you want the remote to operate (VCR, cable box, satellite receiver)
2. Press and hold the component button on the remote control that corresponds to the component you want the remote to operate (VCR1, SAT•CABLE). While you hold down the component button, press and hold ON•OFF (when the light on the remote turns on, release both buttons).
3. Press PLAY (the light on the remote, located below the ON•OFF button, starts flashing).

The remote is searching the first set of component codes (there are 20 sets of codes). If the component you want to operate doesn't turn off automatically after 5 seconds, press PLAY again (the light starts flashing again as the remote searches through the next set of codes).

Continue pressing PLAY until the component turns off.

Note: If the component doesn't turn off after you've pressed the PLAY button 20 times, the component can't be programmed.

4. Press REVERSE, wait 2 seconds. Repeat this step until the component turns back on.
5. To finish, press and hold the STOP button until the light on the remote turns off.

Using Direct Entry

1. Turn on the component you want the remote to operate.
2. Look up the brand and code number(s) for the component on the code list on page 7.
3. Press and hold the component button that corresponds to the component you want the remote to operate (VCR1, VCR2, SAT•CABLE, or AUX)
4. Enter the code from the code list.
5. Release the component button.
6. Press ON•OFF to see if the component responds to the remote commands. If it doesn't, try pressing the component button and then ON•OFF again.
7. If you get no response, repeat these steps using the next code listed for your brand until the component responds to the remote commands.

Note: If you try all the codes for your component brand and none work, try the automatic code search method. If automatic code search doesn't find the code, the remote is not compatible with your component.

Tip

The buttons might operate differently for other components, especially when you're using another component's menu system.

How to Use the Remote After You've Programmed It

Once the remote has been programmed successfully, you are ready to use it to control your components. To operate the component:

1. Press the component button (VCR1, VCR2, SAT•CABLE, or AUX) to set the remote to operate the component.
2. Press ON•OFF to turn the component ON or OFF.
3. Use the remote buttons that apply to that component.

Note: If you keep pressing buttons and nothing happens, the remote is probably in the wrong mode. You must press the component button that matches the component you want to operate (i.e., if you want to operate the VCR, press VCR1 on the remote control to put the remote in VCR mode.)

Using the Remote Control

Code List

VCR Codes

Program to VCR1, VCR2, AUX buttons

| | |
|-----------------|--|
| Admiral | 2131 |
| Adventura | 2026 |
| Aiko | 2027 |
| Aiwa | 2002, 2026 |
| Akai | 2003, 2004, 2005, 2007, 2008, 2111, 2112, 2113 |
| American High | 2021 |
| Asha | 2013 |
| Audio Dynamics | 2009, 2010 |
| Audiovox | 2014 |
| Bell & Howell | 2011 |
| Beaumont | 2013 |
| Broksonic | 2012, 2025 |
| Calix | 2014 |
| Candle | 2013, 2014, 2015, 2016, 2017, 2018, 2019 |
| Canon | 2021, 2022, 2114 |
| Capelhart | 2020, 2110 |
| Carver | 2062 |
| CCE | 2027, 2061 |
| Citizen | 2013, 2014, 2015, 2016, 2017, 2018, 2019, 2027 |
| Colortyme | 2009 |
| Colt | 2061 |
| Craig | 2013, 2014, 2023, 2061 |
| Curtis-Mathes | 2000, 2002, 2009, 2013, 2016, 2018, 2021, 2022, 2024, 2115 |
| Cybernex | 2013 |
| Daewoo | 2015, 2017, 2019, 2025, 2026, 2027, 2028, 2110 |
| Daytron | 2110 |
| Dbx | 2009, 2010 |
| Dimensia | 2000 |
| Dynatech | 2002, 2026 |
| Electrohome | 2014, 2029 |
| Electrosonic | 2014 |
| Emerson | 2002, 2012, 2014, 2015, 2021, 2024, 2025, 2026, 2029, 2030, 2032, 2033, 2034, 2035, 2036, 2037, 2038, 2039, 2040, 2041, 2042, 2044, 2045, 2047, 2065, 2105, 2113, 2116, 2117, 2130 |
| Fisher | 2011, 2023, 2048, 2049, 2050, 2051, 2052, 2118 |
| Fuji | 2021, 2119 |
| Funai | 2002, 2026 |
| Garrard | 2026 |
| GE | 2000, 2001, 2013, 2021, 2022, 2053, 2115, 2120 |
| Goldstar | 2009, 2014, 2018, 2054, 2121 |
| Gradiente | 2026 |
| Harley Davidson | 2026 |
| Harman Kardon | 2009 |
| Harwood | 2061 |
| Headquarter | 2011 |
| Hitachi | 2002, 2055, 2056, 2057, 2107, 2111, 2120, 2122 |
| HI-Q | 2023 |
| Instant Replay | 2021 |
| JCL | 2021 |
| JC Penney | 2009, 2010, 2011, 2013, 2014, 2021, 2022, 2055, 2056, 2058, 2059, 2060, 2107, 2118 |
| Jensen | 2055, 2056, 2111 |
| JVC | 2009, 2010, 2011, 2018, 2058, 2111, 2123 |
| Kenwood | 2009, 2010, 2011, 2016, 2018, 2058, 2111, 2123 |
| KLH | 2061 |
| Kodak | 2014, 2021 |
| Lloyd | 2002, 2026 |
| Logik | 2061 |
| LXI | 2014 |
| Magnavox | 2021, 2022, 2062, 2063, 2104, 2108, 2124 |
| Magnin | 2013 |
| Marantz | 2009, 2010, 2011, 2016, 2018, 2021, 2058, 2062, 2064 |
| Marta | 2014 |
| Masushita | 2021 |
| MEI | 2021 |
| Memorex | 2002, 2011, 2013, 2014, 2021, 2023, 2026, 2104, 2131 |
| MGA | 2029, 2065, 2113 |
| MGN Technology | 2013 |
| Midland | 2053 |
| Minolta | 2055, 2056, 2107 |
| Mitsubishi | 2029, 2055, 2056, 2065, 2066, 2067, 2069, 2070, 2071, 2072, 2073, 2074, 2106, 2113, 2123 |
| Montgomery Ward | 2075, 2131 |
| Motorola | 2021, 2131 |

| | |
|---------------------|--|
| MTC | 2002, 2013, 2026 |
| Multitech | 2002, 2013, 2016, 2026, 2053, 2061 |
| NEC | 2009, 2010, 2011, 2016, 2018, 2058, 2064, 2076, 2078, 2079, 2111, 2123 |
| Nikko | 2014 |
| Noblex | 2013 |
| Olympus | 2021 |
| Optimus | 2014, 2131 |
| Optonica | 2096 |
| Orion | 2035 |
| Panasonic | 2021, 2022, 2109, 2125, 2126, 2127 |
| Pentax | 2016, 2055, 2056, 2107, 2120 |
| Pentex Research | 2018 |
| Philco | 2021, 2022, 2062, 2063 |
| Philips | 2021, 2062, 2096, 2124 |
| Pilot | 2014 |
| Pioneer | 2010, 2055, 2080, 2081, 2123 |
| Portland | 2016, 2017, 2019, 2110 |
| ProScan | 2000, 2001 |
| Protec | 2061 |
| Pulsar | 2104 |
| Quarter | 2011 |
| Quartz | 2011 |
| Quasar | 2021, 2022, 2125 |
| RCA | 2000, 2001, 2003, 2013, 2021, 2055, 2056, 2082, 2083, 2084, 2085, 2086, 2087, 2088, 2089, 2090, 2091, 2107, 2115, 2120, 2125 |
| Radiohack/Realistic | 2002, 2011, 2013, 2014, 2021, 2022, 2023, 2026, 2029, 2049, 2050, 2096, 2131 |
| Radix | 2014 |
| Randex | 2014 |
| Ricoh | 2128 |
| Runco | 2104 |
| Samsung | 2005, 2013, 2015, 2033, 2053, 2112 |
| Sanky | 2131, 2104 |
| Sansui | 2010, 2092, 2111, 2123 |
| Sanyo | 2011, 2013, 2023 |
| Scott | 2012, 2015, 2025, 2032, 2035, 2038, 2065, 2093, 2116 |
| Sears | 2011, 2014, 2021, 2023, 2048, 2049, 2050, 2051, 2055, 2056, 2107, 2118 |
| Sharp | 2002, 2017, 2029, 2094, 2095, 2096, 2131 |
| Shintom | 2004, 2056, 2061, 2098 |
| Shogun | 2013 |
| Signature | 2002, 2131 |
| Singer | 2021, 2061, 2128 |
| Sony | 2002, 2004, 2098, 2099, 2119, 2128 |
| STS | 2021, 2107 |
| Sylvania | 2002, 2021, 2022, 2026, 2062, 2063, 2065, 2124 |
| Symphonic | 2002, 2026 |
| Tandy | 2002, 2011 |
| Tashiko | 2014 |
| Tatung | 2058, 2111 |
| TEAC | 2002, 2026, 2058, 2085, 2111 |
| Technics | 2021, 2109 |
| Teknika | 2002, 2014, 2021, 2026, 2100, 2129 |
| TMK | 2013, 2024, 2047 |
| Toshiba | 2015, 2049, 2051, 2055, 2065, 2093, 2116 |
| ToteVision | 2013, 2014 |
| Unitech | 2013 |
| Vector Research | 2009, 2010, 2015, 2016 |
| Victor | 2010 |
| Video Concepts | 2009, 2010, 2015, 2016, 2113 |
| Videosonic | 2013 |
| Wards | 2002, 2013, 2014, 2015, 2021, 2023, 2026, 2029, 2055, 2056, 2061, 2096, 2101, 2102, 2103, 2107, 2116, 2131 |
| XR-1000 | 2021, 2026, 2061 |
| Yamaha | 2009, 2010, 2011, 2018, 2058, 2111 |
| Zenith | 2004, 2098, 2104, 2119, 2128 |

Cable Boxes Codes

Program to SAT•CABLE or AUX button

| | |
|--------------|--|
| ABC | 5002, 5003, 5004, 5005, 5006, 5007, 5053 |
| Antronix | 5008, 5009 |
| Archer | 5008, 5009, 5010, 5011 |
| Cabletenna | 5008 |
| Cableview | 5008 |
| Century | 5011 |
| Citizen | 5011 |
| Colour Voice | 5012, 5013 |
| Comtronics | 5014, 5015 |

| | |
|--------------------|--|
| Contec | 5016 |
| Eastern | 5017 |
| Garrard | 5011 |
| GC Electronics | 5009 |
| Gemini | 5018, 5019, 5049 |
| General Instrument | 5003 |
| Hamlin | 5020, 5021, 5022, 5035, 5045 |
| Hitachi | 5003 |
| Hytex | 5002 |
| Jasco | 5011 |
| Jerrold | 5003, 5005, 5007, 5018, 5023, 5024, 5046, 5053 |
| Magnavox | 5025 |
| Memorex | 5026 |
| Movie Time | 5002, 5027, 5028 |
| NSC | 5002, 5027, 5028 |
| Oak | 5002, 5016, 5029 |
| Panasonic | 5048, 5052 |
| Paragon | 5026 |
| Philips | 5011, 5012, 5013, 5019, 5025, 5030, 5031, 5032 |
| Pioneer | 5033, 5034 |
| Pulsar | 5026 |
| RCA | 5047, 5049, 5052 |
| Realistic | 5009, 5049 |
| Regal | 5022, 5035 |
| Regency | 5017 |
| Rembrandt | 5003 |
| Runco | 5026 |
| Samsung | 5014, 5034 |
| Scientific Atlanta | 5006, 5036, 5037, 5038 |
| Signal | 5014, 5018 |
| Signature | 5003 |
| SL Marx | 5014 |
| Sprucer | 5052 |
| Starcom | 5007, 5018, 5053 |
| Stargate | 5014, 5018 |
| Starquest | 5018 |
| Tandy | 5040 |
| Television | 5014 |
| Tocom | 5004, 5023, 5041 |
| Toshiba | 5026 |
| Tusa | 5018 |
| TV86 | 5027 |
| Unika | 5008, 5009, 5011 |
| United Artists | 5002 |
| United Cable | 5053 |
| Universal | 5008, 5009, 5010, 5011 |
| Videoway | 5044 |
| Viewstar | 5015, 5025, 5027, 5040 |
| Zenith | 5026, 5050, 5051 |

Satellite Receivers Codes

Program to SAT•CABLE or AUX button

| | |
|---------------------|------------------|
| Chapparral | 5056, 5057 |
| Drake | 5058, 5059 |
| GE | 5000 |
| General Instruments | 5060, 5061, 5062 |
| Panasonic | 5075 |
| Primestar | 5076 |
| ProScan | 5000 |
| RCA | 5000 |
| Realistic | 5063 |
| Sony | 5072 |
| STS1 | 5064 |
| STS2 | 5065 |
| STS3 | 5066 |
| STS4 | 5067 |
| Toshiba | 5068 |
| Toshiba | 5073 |
| Uniden | 5069 |

Audio Codes

Program to AUX button (for Dimensia and some RCA brands only)

| | |
|-------|------|
| AM/FM | 4003 |
| Aux | 4004 |
| Phono | 4005 |
| CD | 4007 |
| Tape | 4006 |

Using the TV's Features

Chapter Overview:

- The Channel Banner
- Parental Controls and V-Chip

Changing Entertainment. Again.



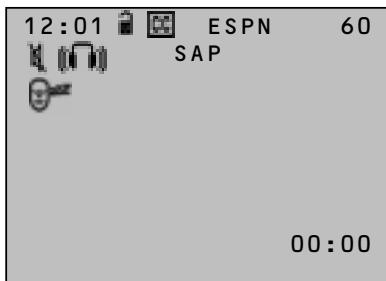





Sample displays on a Channel Banner.

Channel Banner

There are several indicators that might appear when you press the DISPLAY button on the remote. This display is called the Channel Banner. The following list describes the items on the Channel Banner screen (left to right and top to bottom).

- | | |
|--|--|
| <i>12:01</i> | Displays the current time. |
|  | The lock is displayed to indicate when Parental Controls are locked or unlocked. |
|  | Displayed when Closed Captioning is available on the current channel. |
| <i>ESPN</i> | Displays the label assigned to the current channel. |
| <i>60</i> | Displays the current channel or input channel. |
|  | Mute is displayed when you mute the audio. |
|  | Stereo is displayed when the current channel is broadcasting in Stereo. |
| <i>SAP</i> | Displayed when the current channel is broadcasting SAP (Second Audio Program) information. |
|  | Displayed when the Sleep Timer has been set. |
| <i>00:00</i> | Displayed to count down time left on the commercial skip (SKIP) timer. |

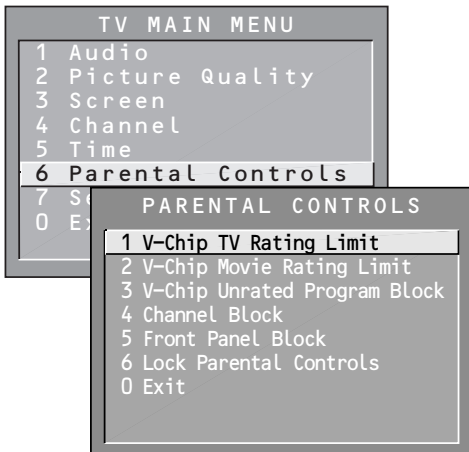

Parental Controls and V-Chip

The *Parental Controls* menu allows you to program your TV so that children cannot see certain programs, channels, or use the front panel controls. The first three choices in the *Parental Controls* menu involve software inside your TV (referred to as V-Chip) which allows you to block TV programs and movies based on violence, sex, or other content you may believe children should not view. In other words, it lets you program your TV so it won't display certain programs.

Once you block programs, you or other adults can unblock programs by entering a password.

By default, the software inside your TV is turned "off," so if you don't want to use this feature, you can just ignore it.



This screen appears when you try to tune to a channel or program that's blocked by Parental Controls. Press DISPLAY on your remote to enter your password.

Important Note About Parental Controls

Once you've locked Parental Controls, the TV blocks the picture of all channels and programs that you've set as blocked. The screen to the left appears when you try to tune to a program or channel that's blocked.

To temporarily unlock Parental Controls when you see the screen to the left:

1. Press DISPLAY on your remote control.
Important: The on-screen display refers to an "INFO" button, which the remote that comes with your TV does not have. Use the DISPLAY button instead.
2. Use the number buttons on your remote to enter your password. If you want to cancel, press CLEAR.
3. Once you've successfully entered your password, press CLEAR to exit.

The Parental Controls function remains unlocked until the next time you turn on your TV.

How V-Chip Works

When turned “on,” the V-Chip software reads a code that most broadcasters send with programs. That code tells the software the program’s age-based rating (TV-MA, TV-14, etc.) and content themes [(Violence (V), Adult Language (L), etc.)]. If you have blocked the rating and/or content themes that the program contains, you will receive the message, “This channel is not approved for viewing,” when you tune to that particular channel.

Broadcasters are not required to provide content themes, so programs received with no content themes will only be blocked if you block their age-based rating. You can also block out programs that have been given a rating of “Not Rated,” and programs that are considered “unrated” because no code has been sent by the broadcaster. The TV age-based ratings and content themes you can block are listed in the following table.

| Age-Based Rating | Description and Content Themes for Age-Based Ratings |
|------------------|--|
| TV-MA | Mature Audience Only. Specifically designed to be viewed by adults and may be unsuitable for children under 17. It contains one or more of the following content themes: crude indecent language (L), explicit sexual activity (S), or graphic violence (V). |
| TV-14 | Parents Strongly Cautioned. Contains some material that many parents would find unsuitable for children under 14. Parents are strongly urged to exercise greater care in monitoring this program and are cautioned against letting children under the age of 14 watch unattended. This program contains one or more of the following content themes: intensely suggestive dialogue (D), strong coarse language (L), intense sexual situations (S), or intense violence (V). |
| TV-PG | Parental Guidance Suggested. Contains material that parents may find unsuitable for younger children. Many parents may want to watch it with their younger children. The program contains one or more of the following content themes: some suggestive dialogue (D), infrequent coarse language (L), some sexual situations (S), or moderate violence (V). |
| TV-G | General Audience. Most parents would find this program suitable for all ages. It contains little or no sexual dialogue (D) or situations (S), no strong language (L), and little or no violence (V). |
| TV-Y7 | Directed to Children 7 years and older. Designed for children ages 7 and above. It may be more appropriate for children who have acquired the developmental skills needed to distinguish between make-believe and reality. Themes and elements in this program may include mild fantasy violence (FV) or comedic violence, or may frighten children under the age of 7. |
| TV-Y | All Children. Themes and elements in this program are designed for a young audience, including children from ages 2-6. It is not expected to frighten younger children. |

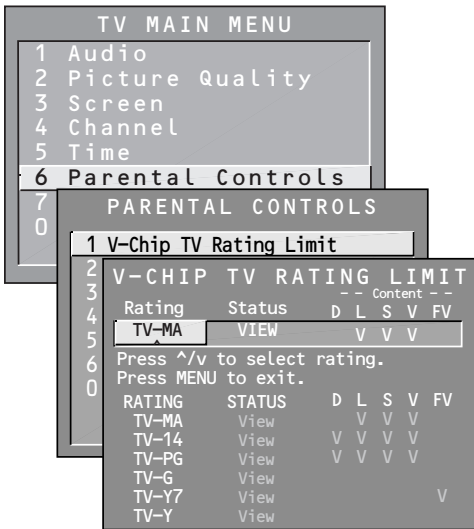

V-Chip TV Rating Limit

The *V-Chip TV Rating Limit* lets you decide which TV programs can and cannot be viewed.

To set TV programming limits:

1. Choose *Parental Controls* from the Main menu. If *Parental Controls* have previously been locked, you must enter your password. If they are not locked, you will get a message reminding you that your limits will not be effective until you lock *Parental Controls*.
2. Press **MENU** to continue.
3. Highlight and select *V-Chip TV Rating Limit*.
4. Once you get to the *V-Chip TV Rating Limit* screen, use the arrow buttons and **MENU** on your remote to change the status of a TV program rating or content theme from *View* to *Block*.

The following sections give you more details about how to change the status of TV program limits.

The V-Chip Rating Limit Screen

The following is an example of where items are located within the Rating Limit screen.

Rating Status Field

Lets you select whether the status of the age-based rating limit to the left is *View* or *Block*.

Content Themes

Lets the content themes you can block or view.

Rating Field

Lets you select from a list of age-based ratings you can block or view.

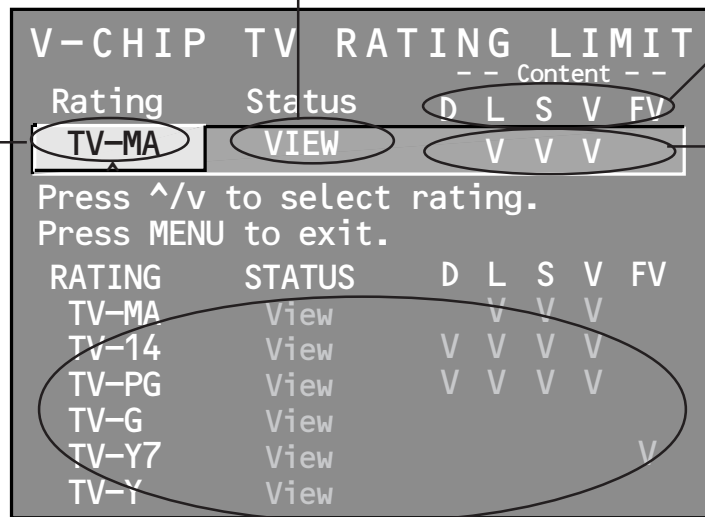

Content Status Fields

Lets you select which content themes to view for the selected rating, and whether the status of the content theme is currently *View* (V) or *Block* (B).

Rating Settings Area

Lets you see the current block/view state of age-based ratings and associated content. The *View* (V) settings are coded in green, and the *Block* (B) settings are coded in red.

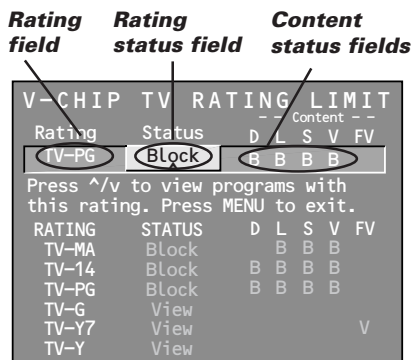

Tip

When you change the status of a rating to *Block*, the system will automatically block higher ratings and all corresponding content themes.

| Hierarchy of Age-Based Ratings | |
|--------------------------------|--|
| TV-MA | Mature Audience Only |
| TV-14 | Parents Strongly Cautioned |
| TV-PG | Parental Guidance Suggested |
| TV-G | General Audience |
| TV-Y7 | Directed to Children 7 years and older |
| TV-Y | All Children |

Blocking Age-Based Ratings

You can automatically block all program ratings above a specified age-based rating level. For example, if you only want your child to watch programs that have a TV-G rating and lower (in other words, you want the child to watch TV-G, TV-Y7, and TV-Y), then you need to block out other programming with higher ratings.

To block programs with higher ratings:

1. First, determine the lowest level rating you don't want the child to watch (see chart of age-based ratings on next page).
2. Press the VOL+ and VOL- buttons to highlight the *Rating* field.
3. Press the CHAN^v and CHAN[^] buttons on the remote to scroll through the age-based rating limits. Keep scrolling until the rating corresponding with the lowest rating you do not want the child to watch appears on the screen.

In the example discussed above, you would scroll through the *Rating* field until TV-PG appears, since the highest rating you want the child to watch is TV-G.

4. Press the VOL+ button to move the yellow highlight to the *Status* field.
5. Press the CHAN^v or CHAN[^] button to toggle between *View* and *Block*. The status for the rating listed to the left and all higher ratings automatically changes to *Block* (and *B*).
6. Press MENU on the remote to return to the menu or exit the screen when you are finished.
7. Select *Lock Parental Controls* from the *Parental Controls* menu. Enter a password, and if you have not already set your password, you will be prompted to enter it again to confirm.

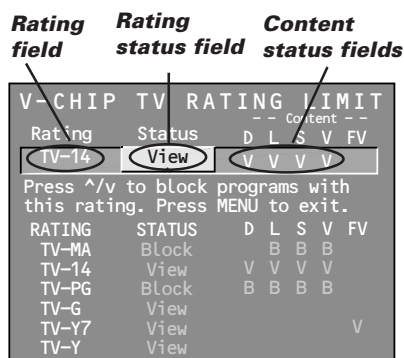

Viewing Age-Based Ratings

After you block age-based ratings, you have the option of changing some of the ratings back to *View*.

1. Determine which blocked rating you want to view.
2. Use the CHAN^v and CHAN[^] buttons to select the rating with a status of *Block*.
3. Press the VOL+ button to move the yellow highlight to the rating status field.
4. Press the CHAN[^] button to select *View*.

Notes: The content status fields corresponding to the unblocked rating become *View* as well. They and the age-based rating status are the only fields that automatically change back to *View* when you complete this process.

You must remember to lock Parental Controls for rating limits to take effect.

| Content Themes | |
|----------------|----------------------------|
| D | Sexually explicit dialogue |
| L | Adult language |
| S | Sexual situations |
| V | Violence |
| FV | Fantasy Violence |

Blocking Specific Content Themes

You can block programs based on their content. (Content is represented by the D, L, S, V and FV on your screen. See the beginning of this section for details.) When you block a content theme for a particular rating, you automatically block that content theme for higher rated programs as well.

For example, if you do not want your child to watch programs that have adult language (L) rated TV-PG or higher, then you could block out all programming TV-PG and above containing adult language.

To block program content:

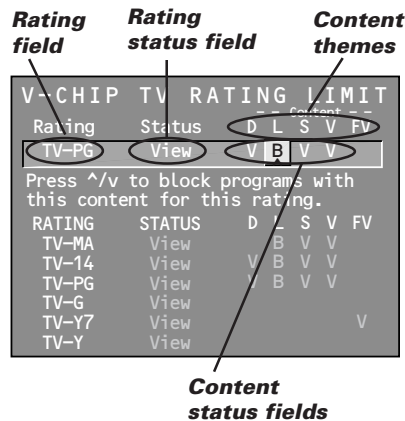

1. Determine the lowest level of content you don't want the child to watch.
2. Use the CHAN ∇ and CHAN \wedge buttons on the remote to scroll through the age-based ratings until the rating that corresponds with the lowest content you do not want the child to watch appears. (In the example above, you would scroll through the ratings until the TV-PG rating appeared.)
3. Press the VOL+ button to move the highlight to the field corresponding with the content theme you wish to block out.
4. Press the CHAN ∇ or CHAN \wedge button to change content status from V to B. All higher ratings' content theme will automatically change to B.
5. Press MENU to return to the menu or exit the screen.

Notes: Broadcasters are not required to provide content themes or age-based ratings. Programs received with no content themes will only be blocked if you block their age-based rating.

You must remember to lock Parental Controls for rating limits to take effect.

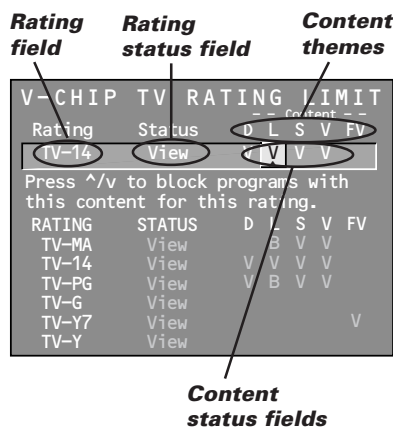

Viewing Specific Content Themes

If you block specific content themes, you have the option of going back and changing some of the content themes back to (V) View:

1. Determine the content themes you want to change to (V) View.
2. Use the CHAN ∇ and CHAN \wedge buttons to scroll through the age-based ratings until the rating whose content theme you want to change to View appears.
3. Press the VOL+ button to move the yellow highlight to a particular content theme status, such as the B under language (L) corresponding with TV-14.
4. Press the CHAN ∇ or CHAN \wedge button to change its status back to V. Your child would then be able to watch programs with TV-14 adult language content, but not programs with TV-PG or TV-MA language content.

Note: Only the content theme status corresponding to TV-14 (L) language changes to (V) View. Higher rated content themes, such as that for TV-MA language, do not change.

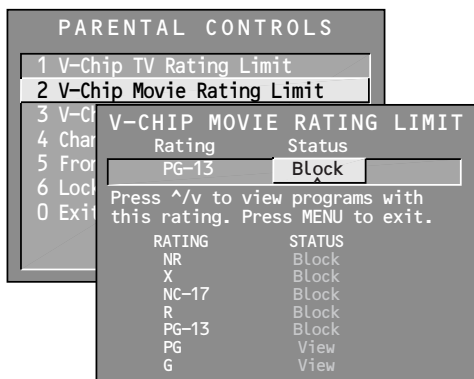

V-Chip Movie Rating Limit

You set movie rating limits by blocking movies rated above a specified level. How to block movie ratings and view movie ratings is explained in the next two sections.

To access the *V-CHIP MOVIE RATING LIMIT* menu:

1. Press **MENU** on the remote control (the *TV MAIN MENU* appears).
2. Select *Parental Controls* (press 6).
3. Select *V-Chip Movie Rating Limit* (press 2).

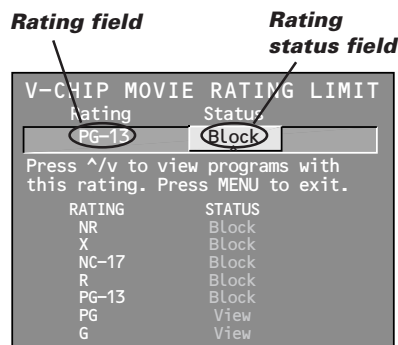

Blocking Movie Ratings

If you only want your child to watch movies that have a PG rating and lower (in other words, movies rated PG and G), then you could automatically block out all other movies with higher ratings.

To block movies:

1. Highlight the *Rating* field and press the **CHAN ∇** and **CHAN \wedge** buttons to find the rating that is the lowest rating you don't want the child to watch. (In the example above, you would highlight the rating status button corresponding to PG-13, since the highest rating you want the child to watch is PG.)
2. Press the **VOL+** button to highlight the rating *Status* field. Press the **CHAN ∇** and **CHAN \wedge** buttons to change the button from *View* to *Block*. All higher ratings automatically change to *Block*.
3. Press **MENU** to return to the menu or exit the screen.
4. If Parental Controls are not locked, you must lock them so the movie rating limits will take effect.

Note: Some movies may be given a Not Rated (NR) rating. After blocking movie ratings, you must set NR to View separately to view NR movies.

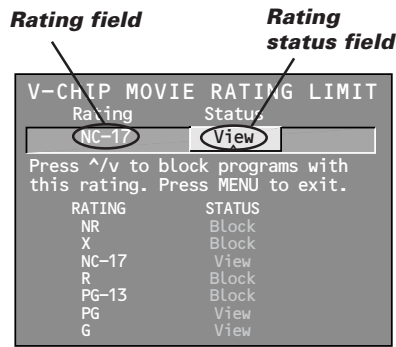

Viewing Movie Ratings

After you block movie ratings, you have the option of changing some of the rating status buttons back to *View*:

1. Highlight the *Rating* field and press the CHANv and CHAN^ buttons to find the rating you want to view.
2. Press the VOL+ button to highlight the rating *Status* field. Press the CHANv and CHAN^ buttons to change the button from *Block* to *View*.

For example, if movies with a rating of PG-13 and higher are blocked, you can change the rating status corresponding with NC-17. Your child would then be able to watch all movies with a G, PG, and NC-17 Rating.

3. Press MENU to exit the screen, and be sure parental controls are locked.

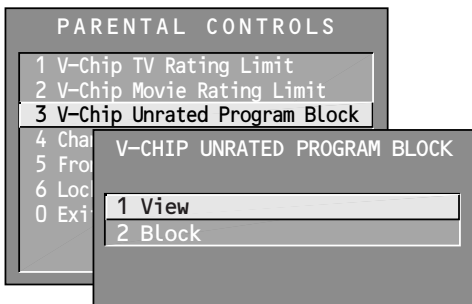

V-Chip Unrated Program Block

Selecting this option lets you decide if programs that the V-Chip recognizes as “unrated” can be viewed. Note that “unrated” TV programs may include news, sports, political, religious, local and weather programs, emergency bulletins, public announcements, and programs without ratings.

View All unrated programs are available.

Block All unrated programs are not available.

Note: You must remember to lock Parental Controls for rating limits to take effect.

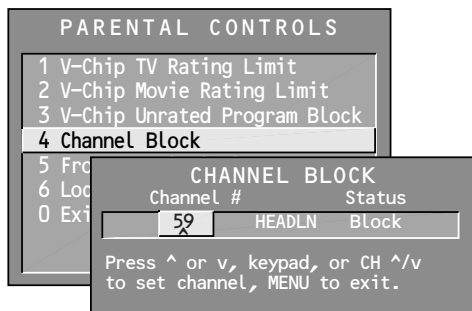

Channel Block

Selecting this option lets you decide what channels can be viewed.

View Makes the selected channel viewable.

Block The front panel and remote control channel buttons will tune only to channels that you have marked as *View*. The remote will still tune to the blocked channel if you use the digits to access the channel, but the channel will be blocked.

Don't forget to lock parental controls after you change the status of *Channel Block*. If you do not, the channel block will not take effect.

Note: If you have a digital cable box channels 126-999 can be blocked but will not be removable from your scan list.

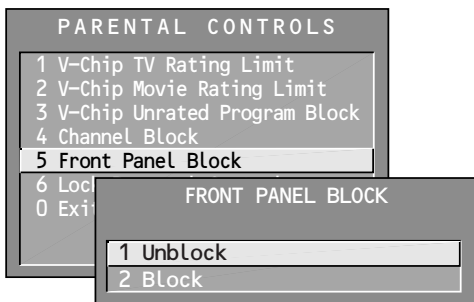

Front Panel Block

Selecting this option lets you block (disable) or unblock (enable) the TV's front panel. The remote still tunes to any channel. *Front Panel Block* can:

- Keep children from watching TV when the parent is not present.
- Keep young children from playing with the buttons.

(When using this as a Parental Control method, you should remove access to any remote that is capable of operating the television while you have the front panel blocked.)

Don't forget to lock parental controls after you change the status. If you do not, the front panel block will not take effect.

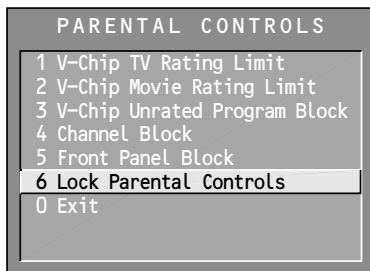

Lock/Unlock Parental Controls

Selecting this option lets you lock and unlock parental controls settings using a password.

If you do not lock parental controls, none of the settings for V-Chip, Channel Block, or Front Panel Block will take effect.

If you forget your password, simultaneously press and hold MENU on the television and volume down on the remote for 3 seconds. Nothing appears on the screen, Parental Controls simply unlock and you can re-enter a password via *Lock Parental Controls*.

Using the TV's Menu System

Chapter Overview:

- How to Use the Different Types of Menus and Control Panels
- Audio Menu
- Picture Quality Menu
- Screen Menu
- Channel Menu
- Time Menu

Changing Entertainment. Again.



How to Use the Different Types of Menus and Control Panels

The TV's menu system has three types of screens: menus, control panels, and choice lists. You use the buttons on the remote or the front panel to access the menu system and make changes to the settings.

The following pages explain how to use the different types of menus to adjust the features of your TV.

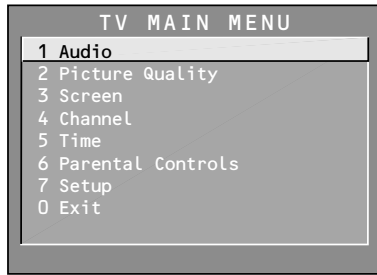

Tip

Feel free to explore the menu system. If you're ever unsure where you are in the menu system, or you're just plain tired of exploring, press CLEAR to remove the menus from the screen and start over again.

Menus

The first menu is called the Main menu. Press MENU on the remote or on the front panel to bring up the Main menu.

Menus take you to another menu or a control panel. There are two ways to select a choice in a menu:

- Use your CHAN and VOL buttons on your remote control to highlight your choice, and press MENU.
- Press a number button on the remote. For example, in the Main menu press 3 to go straight to the *Screen* menu.

Exiting a menu

There are three ways to exit a menu:

- Highlight *Exit* and press MENU.
- Press 0 on the remote.
- Press CLEAR. The on-screen displays are cleared from the screen and you return to TV viewing.

Control Panels

Control panels allow you to adjust the default settings on many features of your TV. You can choose a setting, enter a number, or adjust a level such as tint or brightness. There are three types of control panels: sliders, numeric entry and choice lists.

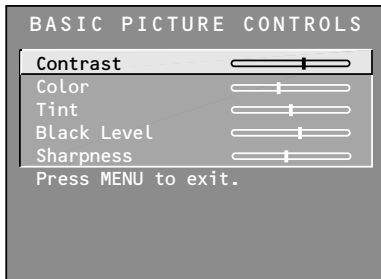

Sliders

Sliders are used to make adjustments to a particular control.

To use a Slider in a menu:

1. Press the CHAN \downarrow or CHAN \wedge button to select the slider control for the feature you want to adjust.
2. Press the VOL+ or VOL- button to adjust the indicator line on the slider.

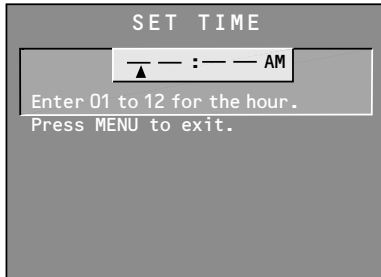

Numeric Entry

A numeric entry control panel is used to enter numbers or letters.

A pointer appears underneath the column you are changing.

1. Use the digits to enter a number in the column above the pointer.
2. Press the VOL+ button to move to the next column, then use the digits to enter a number.
3. When you have finished entering information, press MENU.

Tip

If the control panel is not set to the current time, use the VOL + and VOL - buttons to go back over the columns and the digits to make changes.

You can also enter numbers by using the CHAN \wedge and CHAN \downarrow buttons on the remote.

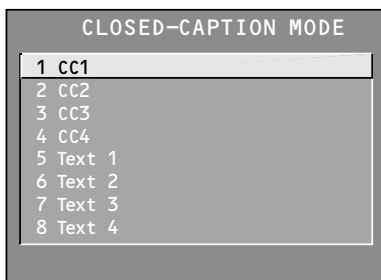

Choice Lists

Choice lists are used to choose a particular setting from a list. When the choice list appears, the highlighted item is the one that is currently selected, or “in use.”

Highlight a choice on a menu and press MENU to select that choice. You will then return to the previous screen.

Now that you know how to access the menus and adjust the control panels the following pages provide a brief explanation of all the menu features. The features are organized in order of their location on the Main Menu.

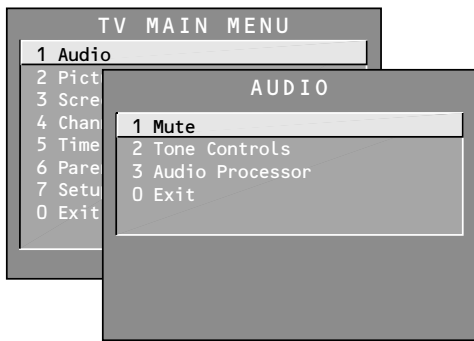

Audio Menu

Mute Press MENU to reduce the TV's volume to its minimum level. Press MENU again to restore the volume.

Tone Controls Displays the slider controls for adjusting the TV's treble, bass and balance.

Audio Processor Displays a choice list of available audio modes, which control the way the sound comes through your speakers.

Mono Plays the sound in mono only. Use this setting when receiving broadcasts with weak stereo signals.

Stereo Splits the incoming stereo audio signal into left and right channels. Most TV programs and recorded materials have stereo audio. The word *STEREO* appears on the TV when you tune to a program that is broadcast in stereo.

Expanded Stereo Electronically "widens" sound from stereo broadcasts, stereo VCRs, digital satellite systems, DVD players, and LaserDisc players for a fuller, more spacious sound.

Sound Logic™ Stereo Reduces the annoying blasts in volume during commercial breaks, and also amplifies softer sounds in program material. Eliminates the need to constantly adjust volume control.

Second Audio Program (SAP) Plays the program's audio in a second language, if one is available. The word *SAP* appears on the TV when you tune to a program that is broadcast with SAP information. SAP audio is broadcast in mono. SAP is also used to broadcast a program's audio with descriptions of the video for the visually impaired.

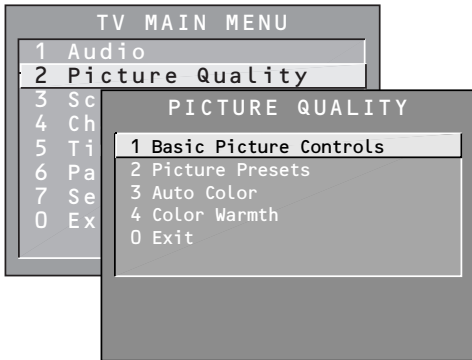

Picture Quality Menu

Basic Picture Controls Displays the five slider controls for adjusting the way the picture looks.

Contrast Adjusts the difference between the light and dark areas of the picture.

Color Adjusts the richness of the color.

Tint Adjusts the balance between the red and green levels.

Black Level Adjusts the brightness of the picture.

Sharpness Adjusts the crispness of the edges in the picture.

When exiting this menu, the *Save Personal Picture Preset* choice list will appear. You can choose either *Yes* or *No*. If you save the settings as a Personal Picture Preset, the TV will store the settings so you can re-select them quickly if someone changes the settings.

Picture Presets Displays a choice list that lets you select one of three preset picture settings: *Bright Lighting*, *Normal Lighting*, *Soft Lighting* or *Personal Picture Preset*. Choose the setting that is best for your viewing environment.

Auto Color Displays a choice list that lets you turn on the feature that automatically corrects the color of the picture. (This is especially useful for tracking realistic flesh tone colors as you switch from channel to channel.) Choose *On* or *Off*, depending on your preference.

Color Warmth Displays a choice list that lets you set one of three automatic color adjustments: *Cool* for a more blue palette of picture colors; *Normal*; and *Warm* for a more red palette of picture colors. The warm setting corresponds to the NTSC standard of 6500 K.

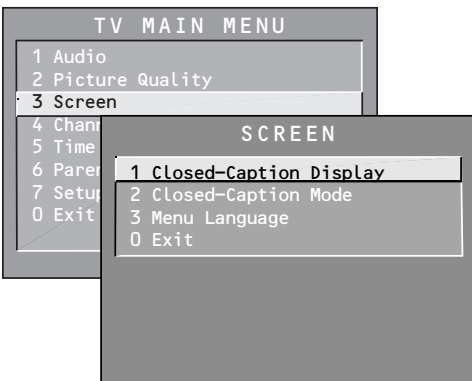

Screen Menu

Closed-Caption Display Displays a choice list that lets you choose the way closed captioning information is shown on the screen.

Off always No captioning information is displayed.

On always Captioning information is shown always, when available.

On when sound is muted Captioning information is shown, when available, whenever the TV's sound is muted. (To mute the sound, press the MUTE button.) The captioning information is not displayed when the sound is not muted.

Closed-Caption Mode Displays a choice list that lets you choose which captioning mode is used for displaying captioning information.

Menu Language Displays a choice list that lets you select your preferred language for the menus: *English*, *Spanish* or *French*.

Using Closed Captioning

Many programs are encoded with closed-captioning information, which lets you display the audio portion of a program as text on the TV screen.

Closed captioning is not available on all channels at all times. Only specific programs encoded with closed-captioning information are applicable. When a program is closed captioned, the *CC* icon is displayed in the channel banner. See Chapter 2 for more information about the channel banner.

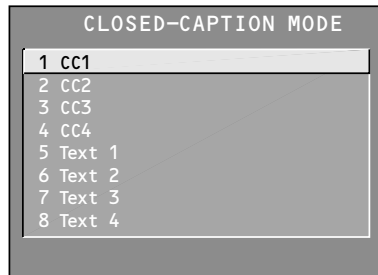

Tip

If you don't know which Closed-Caption mode to use, select CC1. CC1 is probably the mode that is used in your area. CC2, CC3, and CC4 are reserved for foreign languages, but are rarely used at this time.

Closed-Caption Modes

The TV offers eight closed-captioned modes, including four text modes.

To set the *Closed-Caption Mode*.

1. Select *Screen* from the Main menu.
2. Highlight *Closed-Caption Mode* and press MENU (the *Closed-Caption Mode* appears).
3. Highlight your choice and press MENU (the *Screen* menu appears again).

Note: The *Text* modes cover nearly half of the picture on the screen to display the closed-captioned text. Most broadcasters use the *CC* mode, which displays a few lines of captions at a time.

Turning off Closed-Caption

1. Select *Screen* from the Main menu.
2. Press MENU to select *Closed-Caption Display*.
3. Highlight *Off Always* and press MENU. The closed captioning is turned off and you go back to the *Screen* menu.

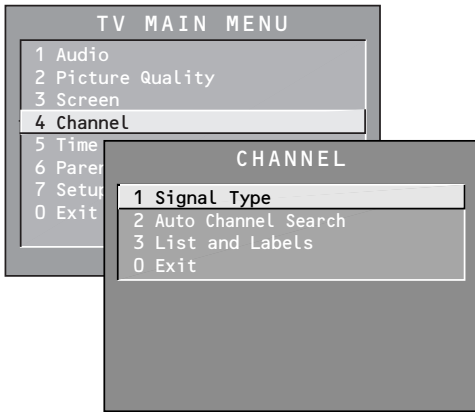

Channel Menu

Signal Type Displays a choice list that lets you select the current antenna type.

UHF/VHF Antenna Choose this if you are currently using an off-air antenna for TV signals.

Cable TV Choose this if you are currently using cable or a cable box for TV signals.

Auto Channel Search Tells the TV to search automatically for all the channels available through the antenna input. When the TV finds an active channel, it places it in the Normal channel list; inactive channels (weak stations or channels with no signal at all) will be removed from the channel list.

List and Labels Displays a control panel that lets you edit your Normal channel list and choose a six-character label for each channel. Follow the on-screen directions to enter your channels and other information.

Channel # Use the CHAN_v and CHAN[^] to scroll up and down through the channels available via your antenna. You can enter the channel number directly using the number buttons.

Normal List Only the channels included in the Normal list are available when you scan up and down using CHAN_v and CHAN[^]. Use the CHAN_v and CHAN[^] buttons to indicate whether the channel number indicated is included (*Yes*) or is not included (*No*) in the Normal channel list.

Channel Label Use the CHAN_v and CHAN[^] buttons to enter a six-character label for each channel. Hold the button down to scroll quickly through the characters. The TV can store up to 27 labels in memory.

Tip

To enter a number greater than 99, press and hold "1" to enter the hundreds digit, then press the two remaining numbers.

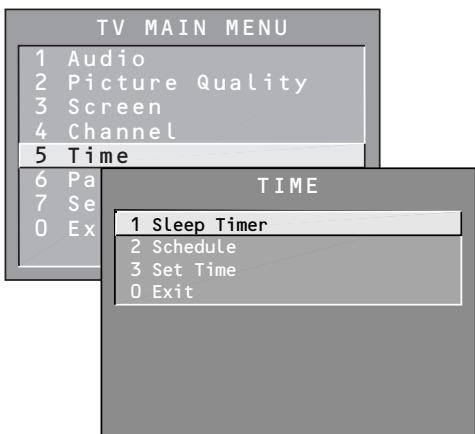

Time Menu

Sleep Timer Displays a control panel that lets you select the amount of time you want to give the TV before it shuts itself off.

Schedule Displays a control panel that lets you set up a schedule for turning the TV on and off automatically. Reminder: you must turn the schedule On. The on-screen directions guide you through the steps needed to set the schedule.

Set Time Displays a control panel that lets you enter the current time. The on-screen directions guide you through the steps needed to set the time.

(This page intentionally left blank)

Other Information

Chapter Overview:

- Troubleshooting
- Care and Cleaning
- Warranty
- Index

Changing Entertainment. Again.



Troubleshooting

Most problems you encounter with your TV you can correct by consulting the Troubleshooting list that follows.

TV Problems

TV won't turn on

- Press the POWER button.
- Make sure the TV is plugged in.
- Check the wall receptacle (or extension cord) to make sure it is “live” by plugging in something else.
- Something might be wrong with your remote control. Press the POWER button on the front of the TV. If the TV turns on, check the remote control solutions on the next page.
- The front panel buttons may be locked (disabled). Use the remote control to unlock the front panel controls by selecting the *Front Panel Block* in the *Parental Controls* menu and choosing *Unblock*.

Buttons don't work

- The front panel buttons may be locked (disabled). Use the remote control to unlock the front panel controls by selecting the *Front Panel Block* in the *Parental Controls* menu and choosing *Unblock*.
- Unplug the TV for two minutes and then plug it back in. Turn the TV on and try again.

TV turns off while playing

- Scheduled Off function may have been activated. Go to page 35 for instructions.
- Electronic protection circuit may have been activated because of a power surge. Wait 30 seconds and then turn the TV on again. If this happens frequently, the voltage in your house may be abnormally high or low.

TV turns on unexpectedly

- Scheduled On may have been activated. Go to page 35 for instructions.

Blank screen

- Make sure the component connected to the TV is turned on.
- Try another channel.

No sound, picture okay

- Maybe sound is muted. Press the volume up button to restore sound.

Can't select certain channel

- Channel may be blocked or not approved in the *Parental Controls* menu.
- If using a VCR, make sure the TV/VCR button on the VCR is in the correct mode (press the TV/VCR button on your VCR).

Noisy stereo reception

- The station might be weak.

No picture, no sound but TV is on

- Maybe the cable/air setting is set to the wrong position. Select *Channel* from the Main menu, select the *Signal Type* option, and provide the correct information on the following screen. Go to page 35 for detailed instructions.
- The channel might be empty — change channels.
- If you're watching your VCR and it's connected with coaxial cable to the CABLE/ANTENNA jack, tune the TV to channel 3 or 4 (whichever channel is selected on the 3/4 switch on the back of your VCR). Also check to make sure the TV/VCR button on the VCR is in the correct mode (press the TV/VCR button on your VCR).

Sound okay, picture poor

- Check antenna connections. Make sure all of the cables are firmly connected to the jacks.
- Try adjusting sharpness function to improve weak signals. Go to page 33 for more instructions.

Black box appears on the screen

- Closed-captioning might be on. Check the *Closed-Caption Display* control panel in the *Screen* menu. Go to page 30 for more instructions.

The Remote Control Doesn't Work

- Something might be between the remote and the remote sensor on the component. Make sure there is a clear path.
- Maybe the remote isn't aimed directly at the TV.
- Maybe batteries in remote are weak, dead or installed incorrectly. Put new batteries in the remote.
- You might need to drain the remote's microprocessor. Remove batteries and press the number 1 button for at least 60 seconds. Release the 1 button, replace the batteries and re-program the remote (if necessary).

Problems with V-Chip/Parental Controls

The rating limits don't work

- You must lock the settings. Go to the *TV MAIN MENU* (press MENU on your remote), select *Parental Controls* (press 6 on your remote), select *Lock Parental Controls* (press 6 on your remote).

I don't remember my password and I want to unlock the TV

- If you forget your password, simultaneously press and hold MENU on the television and VOL – (volume down) on the remote for 3 seconds. Nothing appears on the screen, Parental Controls simply unlock and you can re-enter a password via *Lock Parental Controls*.

The V-Chip won't let me watch a program even though it's not rated as violent.

- Maybe the movie was given an NR (Not Rated) status. After you block movie ratings, you must set *NR* to *View* separately in order to view movies with an NR rating.

Care and Cleaning

CAUTION: Turn OFF your TV before cleaning.

You can clean the TV as required, using a soft lint-free cloth. Be sure to occasionally dust the ventilation slots in the cabinet to help assure adequate ventilation.

The TV's screen may be cleaned with a soft, lint-free cloth as well. Take care not to scratch or mar the screen. If necessary, you may use a cloth dampened with warm water. Never use strong cleaning agents, such as ammonia-based cleaners, or abrasive powder. These types of cleaners will damage the TV.

While cleaning do not spray liquid directly on the screen, or allow liquid to run down the screen and inside the TV. Also, avoid placing drinks or vases with water on top of the TV. This could increase the risk of fire or shock hazard or damage to the TV.

Caution: Using video games or any external accessory with fixed images for extended periods of time can cause them to be permanently imprinted on the picture tube (or projection TV picture tubes). ALSO, some network/program logos, phone numbers, etc. may cause similar damage. This damage is not covered by your warranty.

Limited Warranty

What your warranty covers:

- Defects in materials or workmanship.

For how long after your purchase:

- 90 days from date of purchase for labor charges.
- One year from date of purchase for parts.
- Two years from date of purchase for the picture tube.

The warranty period for rental units begins with the first rental or 45 days from date of shipment to the rental firm, whichever comes first.

What we will do:

- Pay any Authorized RCA Television Service Center the labor charges to repair your television.
- Pay any Authorized RCA Television Service Center for the new or, at our option, refurbished replacement parts and picture tube required to repair your television.

How you get service:

- For 20" screen size: Take your RCA television to any Authorized RCA Television Service Center and pick up when repairs are complete.
- For screen sizes larger than 20": Request home or pick up, repair, and return service from any Authorized RCA Television Service Center, provided that your television is located within the geographic territory covered by an Authorized RCA Television Service Center. If not, you must take your television to the Service Center location at your own expense, or pay for the cost the Service Center may charge to transport your television to and from your home.
- To identify your nearest Authorized RCA Television Service Center, ask your dealer, look in the Yellow Pages, or call 1-800-336-1900.
- Proof of purchase in the form of a bill of sale or receipted invoice which is evidence that the product is within the warranty period must be presented to obtain warranty service. For rental firms, proof of first rental is also required.

What your warranty does not cover:

- Customer instruction. (Your Owner's Manual describes how to install, adjust, and operate your television. Any additional information should be obtained from your dealer.)
- Installation and related adjustments.
- Signal reception problems not caused by your television.
- Damage from misuse or neglect.
- Batteries.
- Customer replacement fuses.
- Images burnt onto the screen.
- A television that has been modified or incorporated into other products or is used for institutional or other commercial purposes.
- A television purchased or serviced outside the U.S.A.
- Acts of nature, such as but not limited to lightning damage.

Product Registration:

- Please complete and mail the Product Registration Card packed with your TV. It will make it easier to contact you should it ever be necessary. The return of the card is not required for warranty coverage.

Limitation of Warranty:

- **THE WARRANTY STATED ABOVE IS THE ONLY WARRANTY APPLICABLE TO THIS PRODUCT. ALL OTHER WARRANTIES, EXPRESS OR IMPLIED (INCLUDING ALL IMPLIED WARRANTIES OF MERCHANTABILITY OR FITNESS FOR A PARTICULAR PURPOSE) ARE HEREBY DISCLAIMED. NO VERBAL OR WRITTEN INFORMATION GIVEN BY THOMSON MULTIMEDIA INC., ITS AGENTS OR EMPLOYEES SHALL CREATE A WARRANTY OR IN ANY WAY INCREASE THE SCOPE OF THIS WARRANTY.**
- **REPAIR OR REPLACEMENT AS PROVIDED UNDER THIS WARRANTY IS THE EXCLUSIVE REMEDY OF THE CONSUMER. THOMSON MULTIMEDIA INC. SHALL NOT BE LIABLE FOR INCIDENTAL OR CONSEQUENTIAL DAMAGES RESULTING FROM THE USE OF THIS PRODUCT OR ARISING OUT OF ANY BREACH OF ANY EXPRESS OR IMPLIED WARRANTY ON THIS PRODUCT. THIS DISCLAIMER OF WARRANTIES AND LIMITED WARRANTY ARE GOVERNED BY THE LAWS OF THE STATE OF INDIANA. EXCEPT TO THE EXTENT PROHIBITED BY APPLICABLE LAW, ANY IMPLIED WARRANTY OF MERCHANTABILITY OR FITNESS FOR A PARTICULAR PURPOSE ON THIS PRODUCT IS LIMITED TO THE APPLICABLE WARRANTY PERIOD SET FORTH ABOVE.**

How state law relates to this warranty:

- Some states do not allow the exclusion nor limitation of incidental or consequential damages, or limitations on how long an implied warranty lasts, so the above limitations or exclusions may not apply to you.
- This warranty gives you specific legal rights, and you also may have other rights that vary from state to state.

If you purchased your product outside the United States:

- This warranty does not apply. Contact your dealer for warranty information.

Service calls which do not involve defective materials or workmanship are not covered by this warranty. Costs of such service calls are the sole responsibility of the purchaser.

Index

A

- Advanced connections 9
- Age-Based Ratings 22
- ANTENNA
 - Button 14
- Arrow buttons 14
- Audio
 - Menu 32
 - Processor 32
- Auto
 - Channel Search 12, 35
 - Color 33
- Automatic code search 16
- AUX (auxiliary) button 14

B

- Basic
 - connections 6, 7
 - Picture Controls 33
- Batteries for the remote 11
- Black Level 33
- Block
 - Age-Based Ratings 24
 - Channel 27
 - Front Panel 28
 - Movie Ratings 26
 - Specific Content Themes 25
 - V-Chip Unrated Program 27
- Buttons, remote control 14

C

- Cable
 - coaxial 5
- CABLE/ANTENNA jack 6, 7, 9
- CC (Closed Captioning) 33, 34
- CH +/- buttons 14
- Channel
 - Banner 20
 - Block 27
 - Labels 35
 - Menu 35
 - Search 12
- Channel guide 14
- CLEAR button 14
- Closed Caption
 - Display 33
 - Mode 33, 34
- Coaxial cable 5
- Code list 18
- Color Warmth 33
- Connections
 - TV + VCR 6
 - TV + VCR + Satellite Receiver 9

- TV Only 7
- Content Themes 22
- Contrast 33
- Control Panels 30

D

- DVD player
 - Remote control button 14

F

- Front panel
 - block 28
 - buttons 10
 - jacks 10

G

- GO BACK button 14
- GUIDE button 14

I

- INFO button 14
- INPUT button 14
- Interactive setup 12

J

- Jacks,
 - Front panel 10

L

- L.E.D. 14
- Labels 35
- Language 33
- Languages, selecting 12
- Lock, Parental Controls 28

M

- Memory 35
- Menu
 - Audio 32
 - Channel 35
 - Language 33
 - Picture Quality 33
 - Screen 33
 - Time 35
- MENU button 14
- Mono 32
- Mute 32
- MUTE button 14

N

- Normal List 35
- Number buttons 14

O

- OK button 14
- ON•OFF button 14

P

- Parental Controls
 - Locking, Unlocking 28
 - menu 21
- PAUSE button 14
- Picture
 - Presets 33
 - Quality Menu 33
- PLAY button 15
- Programming the remote 15, 18

R

- Rating Limits
 - movies 26
 - TV 23
- Remote, batteries 11
- Remote control
 - Arrow buttons 14
 - Automatic code search 16
 - Buttons 14, 15
 - Codes 18
 - L.E.D. 14
 - Programming 15

S

- SAP 32
- SAT•CABLE button 15
- Satellite Receiver, connecting 9
- Schedule 35
- Screen menu 33
- Second Audio Program (SAP) 32
- Set Time 35
- Sharpness 33
- Signal Type
 - Cable TV 35
 - UHF/VHF Antenna 35
- SKIP button 15
- Sleep Timer 20, 35
- SOUND button 15
- Stereo 32
- STOP button 15

T

- Tint 33
- Tone Controls 32
- Transport buttons 14
- Troubleshooting 38
- TV button 15
- TV, connecting 7

U

- UHF/VHF Antenna 35
- Unlock, Parental controls 28

V

- V-Chip 21
 - Age-Based Ratings 22
 - Blocking Movies 26
 - Content Themes 22
- VCR, connecting 6
- VCR1/VCR2 buttons 15
- VOL up/down buttons 15

W

- Warranty 40

(This page intentionally left blank)

(This page intentionally left blank)

Please do not send any products to the Indianapolis address listed in this manual or on the carton. This will only add delays in service for your product.

Thomson multimedia Inc.
10330 North Meridian Street
Indianapolis, IN 46290

©2002 Thomson multimedia Inc.
Trademark(s)® Registered
Marca(s) Registrada(s)
Printed in USA
TOCOM 15934240

