

Rear-projection TV with HD Input

43PP8545

50PP8545

User manual



Contents

Thank you for purchasing this television set. You are now the proud owner of a Philips TV, which promises full value to you as a customer. Please read this manual carefully and thoroughly for help with installation and operation.

Setup and Installation

Product Highlights.....	3
Installing the TV.....	4
Using the TV Keys.....	5
Using the Remote Control Keys.....	6-7

Operation

Using the Menus.....	7-17
Overview.....	7
Install.....	8-10
Picture.....	11-13
Sound.....	14
Features.....	15-17
Using Smart Surf.....	18
Using Smart Picture and Smart Sound.....	19
Using Teletext (if provided).....	20-21

Peripheral Equipment

Connecting Peripheral Equipment.....	22-24
Selecting Connected Equipment for Viewing.....	24

General Information

Care, Cleaning and Tips.....	25
Before Calling Service.....	26
Specifications.....	27

Safety Information

- No naked flame sources, such as lighted candles, should be placed on top of the TV or in the vicinity.
- Do not place your TV set under direct sunlight or heat.
- Leave at least 5 cm around each side of TV set to allow for proper ventilation.
- Avoid placing your set (e.g. near the window) where it is likely to be exposed to rain or water.
- No objects (such as vases) filled with liquids should be placed on top the TV so as to avoid dripping or splashing of liquids on the set.

Disconnect mains plug when:

- the red light below the TV screen is flashing continuously
- a bright white line is displayed across the screen
- cleaning the TV screen (never use abrasive cleaning agents; use a slightly damp chamois leather or soft cloth)
- a lightning storm is occurring
- the set is left unattended for a prolonged period.

Never attempt to repair a defective TV yourself. Always consult a skilled service person.

Battery Usage CAUTION

To prevent battery leakage which may result in bodily injury or damage to the remote:

- Install ALL batteries correctly, + and – as marked on the remote control.
- Do not mix batteries: (OLD and NEW or CARBON and ALKALINE, etc.).
- Remove batteries when the remote is not used for a long time.

Product Highlights

See it as an eyewitness

- Progressive Scan – double the visible picture lines for better resolution
- 100Hz Digital Scan eliminates flicker and line jitter for stable picture
- HDTV Monitor – HDTV is the latest and best television signal available
- Acclearium™ Digital Optics maximizes picture quality on all inputs
- Saphlon™ Screen – better picture and scratch resistance

Technology made simple

- Active Control measures signal to produce best picture
- Auto IntelliSense™ Focus – one-touch automatic convergence of the CRT tubes
- APAC – Automatic Phosphor Aging Compensation

Rich sound experience

- Virtual Dolby®* Surround – surround sound without additional rear speakers

Product highlights

100Hz Digital Scan

Conventional TV creates a picture by scanning 50 times per second (50Hz). This frequency can be detected by the human eye in the form of a field flickering picture. 100Hz sets scan 100 times per second, eliminating the field flickering.

Progressive Scan

A picture frame consists of two fields: the field with the odd lines (field A) and the field with the even lines (field B). Instead of sending field A to the screen first, followed by field B, the fields A and B are written at one time. In one second, a full image is created using the maximum resolution. At this speed, the human eye perceives a sharper picture with no line structure.

HDTV Monitor

HDTV Display Capability (1080i). HDTV monitors enable you to view high-definition or enhanced-definition TV programming in the 1080i or 480p signal format. In order to do so, the TV must be connected via its component video or RGB inputs to a set-top box, which is set to operate in the DTV mode. A DTV signal must be present in your area and the set-top box must be tuned to the proper channel. An external over-the-air antenna may be required. Another option is HDTV broadcast satellite service. Stunning realism in both picture and sound are delivered!

Acclearium™ Digital Optics

Philips micro phosphor CRTs feature improved optics for sharper, more detailed images and enhanced green phosphor, which creates deeper, more natural colours. Hybrid projection lenses work in concert with each CRT to improve focus and correct optical errors, removing distortion and creating a crisp picture to the edge of the screen. The lenticular screen has nearly one-third finer pitch (.515mm) than traditional screens improving picture detail and resolution. The Philips Wideband Video Amplifier reproduces the highest visible bandwidth in its class – resulting in significantly more picture detail in pure HD.

Saphlon™ Screen

Saphlon™ Screen technology is built with materials and processes that deliver more brightness and picture contrast. It guards against most scratches and fingerprints and eliminates the glare associated with a separate protective screen.

Auto IntelliSense™ Focus

Sensors in the TV scan a predefined test pattern and readjust the signal on the CRTs to assure that red, green and blue are well aligned.

Active Control

With over 3,000 picture adjustments per minute, this 'proactive control system' continuously analyzes incoming video signal qualities for Dynamic Noise Reduction and sharpness and then automatically corrects them to be like the settings you previously selected in the picture menu.

APAC

APAC is designed to minimize the effects of image retention from stationary images on the screen. Because both analog sources (cable TV and DVD) and digital sources (HD and progressive scan DVD) have different aspect ratios (4:3, 16:9, 21:9, etc.), the picture on a digital television may have black bars on the sides or top and bottom. When black bars are detected in either the 4:3 or 16:9 viewing mode, APAC automatically shifts the television picture pixel-by-pixel, just enough to soften image retention. APAC works in both the analog and digital modes, so it provides excellent protection.

Active Control and APAC, are trademarks of Philips Consumer Electronics North America. IntelliSense is a registered trademark of Philips Consumer Electronics North America. Copyright 2002 Philips Consumer Electronics.

**Manufactured under license from Dolby Laboratories. "Dolby" and the double-D symbol are trademarks of Dolby Laboratories.*

Installing the TV

- 1 The major benefit of this projection television is its large viewing screen. To see the large screen at its best, test various locations in the room to find the optimal spot for viewing.

Be sure to allow a minimum of 15 cm of space around the TV.

To avoid cabinet warping, cabinet colour changes, and increased chance of set failure, do not place the TV where temperatures can become excessively hot – for example, in direct sunlight or near a heating appliance.

Magnetic fields, such as those of external speakers, may cause the picture to distort if the speakers are placed too close to the television. Move the magnetic field source away from the TV until there is no picture distortion.

- 2 Insert the aerial plug firmly into the ANTENNA IN 75Ω socket at the rear of the set.
- 3 Insert the mains plug in the wall socket. Refer to the back of the TV set for the correct operation voltage. Consult your local dealer if your main supply is different. To prevent damaging the mains (AC) cord, which could cause hazard, do not place the TV on the cord.
- 4 Remove the cover of the battery compartment on the remote control. Insert the two batteries supplied (Type R6-1.5V).

The batteries supplied do not contain the heavy metals mercury and cadmium. Nevertheless, in many countries exhausted batteries may not be disposed of with your household waste. Please check on how to dispose of exhausted batteries according to local regulations.

See the battery caution statement on page 2.

Note: This remote control functions with TVs that use the RC5 signalling standard.

- 5 Switch the TV on: Press the mains power switch on the front of the TV. If the Standby key is lighted, press the CH +/- keys, digit keys or the Power key on the remote control. Or press the Standby or CHANNEL keys on the front of the TV.

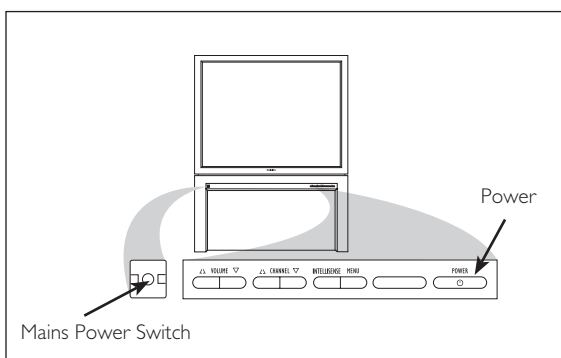
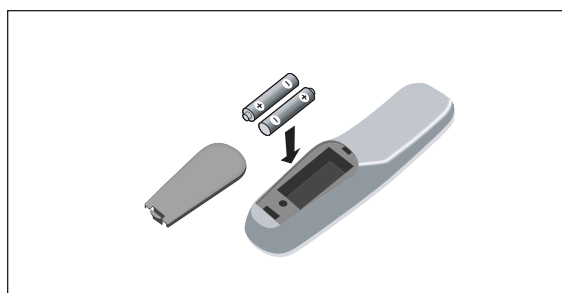
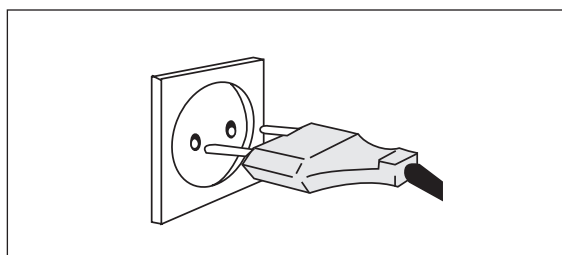
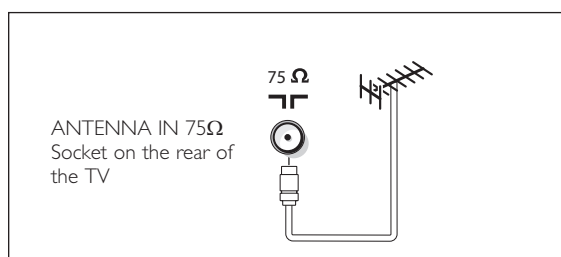
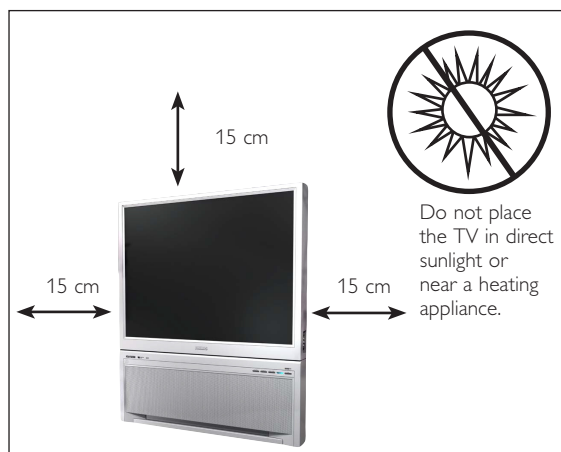

Using the TV Keys

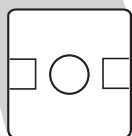

MAINS POWER KEY

Switches the mains power on or off.

VOLUME ▽△

The ▽ key adjusts the sound volume softer. The △ key adjusts the sound volume louder.

CHANNEL ▽△

The ▽ key selects channels in descending order. The △ key selects channels in ascending order. When the onscreen menu is displayed, pressing ▽ or △ selects the next item in the menu. Also, use either of these keys to switch the TV on from Standby mode.

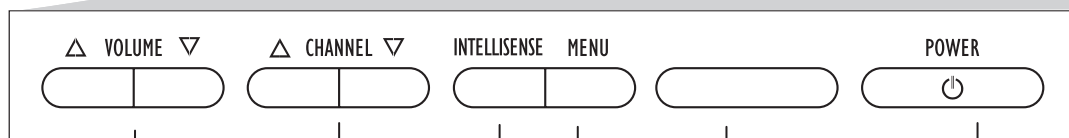

POWER

Switches the TV on or activates standby mode.

REMOTE SENSOR

Receives infrared commands to activate controls when the remote control handset is aimed at it and remote keys are pushed.

MENU

Press to activate the on-screen menu.

INTELLISENSE

When pressed, automatically adjusts the set's picture convergence using the Auto IntelliSense® focus feature.

Using the Remote Control Keys

1 (STANDBY)

- Switches the set off temporarily to standby mode. (The red light indicator lights up when the set is in standby mode.)
- To switch the set on from standby mode, press the Standby, CH +/-, or Digit (0-9) keys.

2 I-II

Allows you to switch from stereo to mono sound during stereo transmission or to choose between language **I** or language **II** during dual sound transmission.

3 A/CH (Alternate Channel)

Allows you to alternate between the last viewed channel and the present channel.

4 TELETEXT

Allows you to navigate through a list of installed programmes for a quick overview of the channels and to activate the channel you have selected. See page 20-21.

5 SMART SOUND

Allows you to select from three predefined optimal settings – Voice, Music and Theatre – and a Personal setting based on your own selections through the onscreen Sound menu. Press the key repeatedly to select a setting. See page 19.

6 DOLBY V. (with Dolby* Surround Signals)

Allows you to select various factory surround-sound listening modes:

Dolby Virtual (Virtual Dolby* Surround)

Dolby Virtual uses two speakers to simulate the surround effect produced by a multichannel system.

Incredible Surround™

- In Stereo sound mode – when switched on, the Incredible Surround™ feature provides the feeling that the speakers are farther apart to enhance the home-cinema effect.
- In Mono sound mode – when switched on, the Incredible Surround feature enables you to hear a spatial sound effect.

7 MENU

Displays the main menu. Also allows you to go backwards in the menu system.

8 CURSOR UP

Allows you to select the next or previous item in the menu and to select a screen format.

9 CURSOR LEFT

Allows you to access the menus and adjust the settings.

10 +/- (VOLUME)

Increases or decreases volume.

11 DIGIT (0-9)

Allows you to select a channel. Note: For a two-digit number, the second digit must be entered before the “—” sign disappears.

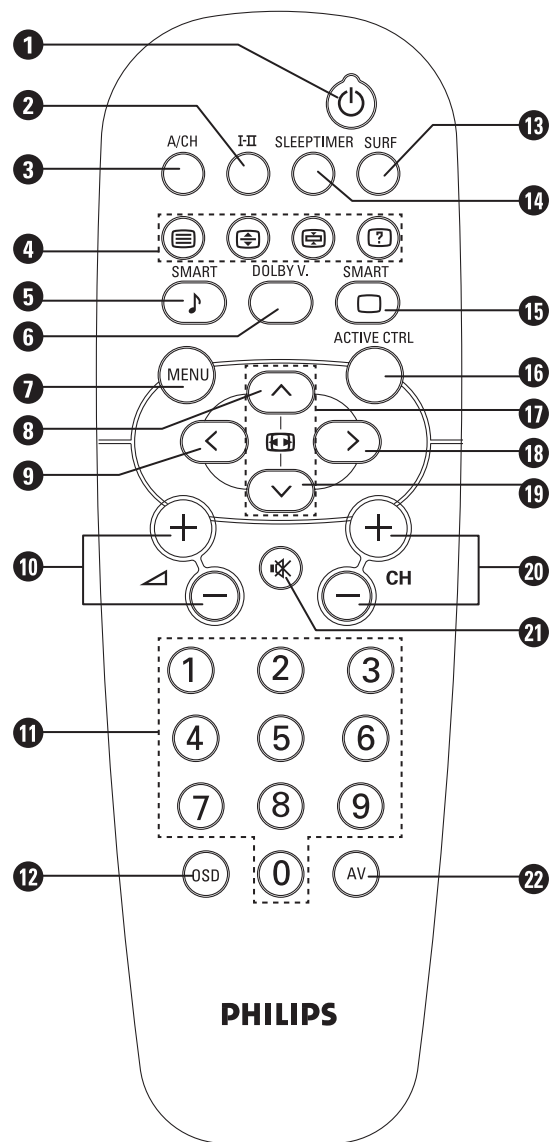

*Manufactured under license from Dolby Laboratories. “Dolby” and the double-D symbol are trademarks of Dolby Laboratories.

12 OSD (STATUS/EXIT)

- Displays the channel number, sound and colour transmission modes, status of the sleep timer, channel name (if the channel has been named) and the current time (if the time has been set).
- Allows you to navigate or make adjustments in multipoint-convergence mode.
- Allows you to switch the menu off.

13 SURF

Allows you to select up to 10 channels and quickly view them. See page 18.

14 Not applicable.

15 SMART PICTURE

Allows you to select from four predefined optimal settings – Rich, Natural, Soft and Multimedia – and a Personal setting based on choices you make through the onscreen Picture menu. See page 19.

16 ACTIVE CONTROL™

Allows you to switch the Active Control™ feature on or off. When Active Control™ is on, it measures and corrects all incoming signals to provide the best picture-quality settings, controlling Sharpness and Noise Reduction continuously and automatically. The onscreen Active Control™ display items cannot be selected. See page 17.

17 (FORMAT)

Each press selects another picture format. For AV1, CVI, AV2, or AV3, the options are 4:3, Auto, and Expand 4:3. For AV4 and AV5 1080i signal sources, the options are 4:3 and Compress 16:9. For AV4 and AV5 480p or 576p signal sources, no screen format options are available through the TV. Control the format at the source (DVD player or digital set-top box).

18 CURSOR RIGHT

Allows you to access the menus and adjust the settings.

19 CURSOR DOWN

Allows you to select the next or previous item in the menu or to select a screen format.

20 CH +/- (CHANNEL)

Allows you to select channels in ascending and descending order.

21 (MUTE)

Allows you to mute the sound. To restore the sound, press the key again.

22 AV

Allows you to select the different signal sources connected to the TV.

Using the Menus: Overview

1 Press the **MENU** key to display/cancel the main menu.

2 Use the cursor in the up/down directions to select a menu item.

Note: Sometimes not all the menu items are visible on the screen; press the cursor up/down until you can see the item you desire.

3 Use the cursor in the left/right directions to display the menu and adjust the settings.

4 Press the **MENU** key to return.

5 Press the **OSD** key to switch the menu off.

Note: If no action is executed, the menu automatically disappears after about 20 seconds.

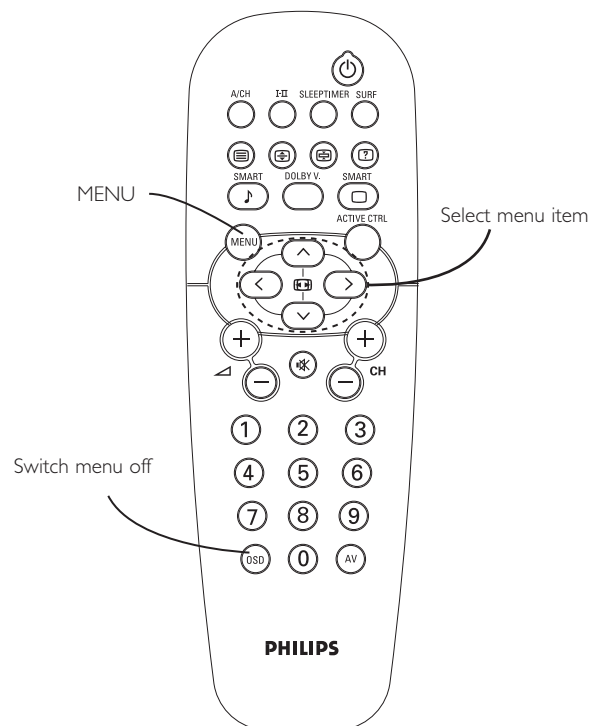

Using the Menus: Install

Selecting the Menu Language

Note: The menu languages available vary by model.

- 1 Press the **MENU** key.
- 2 Select **INSTALL** with the cursor down.
- 3 Press the cursor right to select **LANGUAGE**.
- 4 Press the cursor right again.
- 5 Select your language with the cursor up/down.

From this point on, all onscreen displays will appear in the language that you have chosen.

Now you can search for and store the TV channels in two different ways: with Auto Store or Manual Store (tuning in channel by channel).

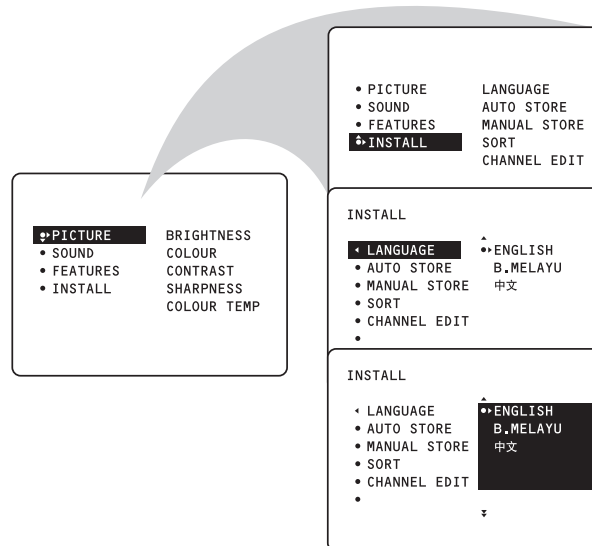

Tuning Channels Automatically

- 1 Select **AUTO STORE** in the **INSTALL** menu.
- 2 Press the cursor right to start the searching. All the TV channels are searched for and stored automatically.
- 3 When the tuning is completed, press the **MENU** key to return to the **INSTALL** menu or press the **OSD** key to switch the menu off.

Note: Channel numbers will always be written in Latin characters, even when a language that uses other characters has been selected.

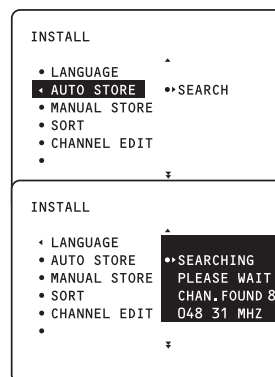

Tuning Channels Manually

Manual tuning allows you to store channel by channel. You must go through every step of the manual store menu.

- 1 Select **MANUAL STORE** in the **INSTALL** menu.
- 2 Press the cursor right to enter the menu.
- 3 Select **COLOUR SYSTEM** and press the cursor right.

If **AUTO** is selected, the respective colour system will be automatically selected according to the transmission system.

Note: If reception is poor, select another colour system with the cursor up/down.

- 4 Press the **MENU** key or the cursor left.
- 5 Select **SOUND SYSTEM** and press the cursor right.

If **AUTO** is selected, the respective sound system will be automatically selected according to the transmission system.

Note: If the reception is poor, select another sound system with the cursor up/down.

- 6 Press the **MENU** key or the cursor left.
- 7 Select **SEARCH** and press the cursor left or right to start the searching. Searching stops once a transmitting channel is found.

Note: If the reception is poor, select another colour and/or sound system.

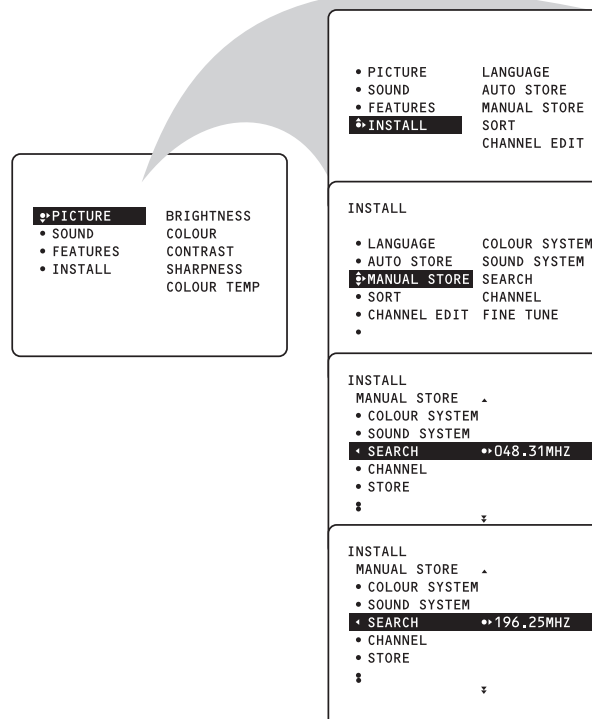

- 8 Select **CHANNEL**.
- 9 Key in the desired channel number with the digit keys or with the cursor left/right.
- 10 Press the cursor down.

In case of poor reception, you can improve the reception by adjusting the frequency using **FINE TUNE**.
- 11 Select **FINE TUNE** and press the cursor left/right to adjust.
- 12 In rare cases, certain TV channels may reproduce distorted or unstable pictures.

Select **PLL** (Phase Locked Loop) to switch to the setting 2 with the cursor left/right to restore the picture for the respective transmission.
- 13 Select **STORE**.
- 14 Press the cursor right.

The message **STORED** appears and the search menu item is highlighted again.
- 15 Now repeat steps 7-14 to continue searching for another transmitting channel.
- 16 Press the **MENU** key to return to the **INSTALL** menu or press the **OSD** key to switch the menu off.

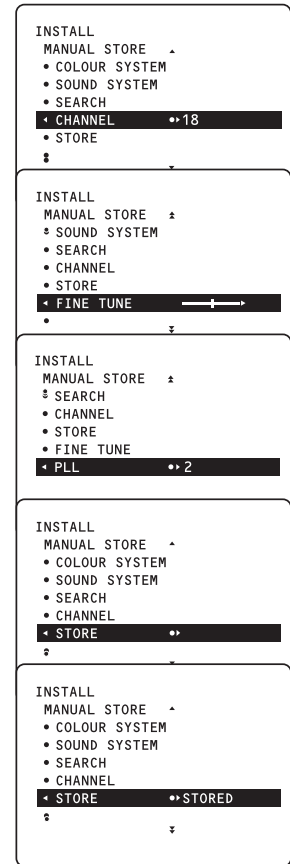

Sorting Channels

According to your preference, you can change the order of the stored TV channels.

- 1 Select **SORT** in the **INSTALL** menu.
- 2 Press the cursor right to enter the menu.
- 3 Key in the channel number in the **FROM** column you want to swap from. Use the digit keys or the cursor left/right.
- 4 Press the cursor down and select **TO**.
- 5 Key in the channel number in the **TO** column you want to swap to.
- 6 Press the cursor down and select **EXCHANGE**.
- 7 Press the cursor right.

The message **EXCHANGED** appears and the selected channels are exchanged.
- 8 Repeat steps 3-7 until all TV channels are allocated as you like.
- 9 Press the **MENU** key to return to the **INSTALL** menu or press the **OSD** key to switch the menu off.

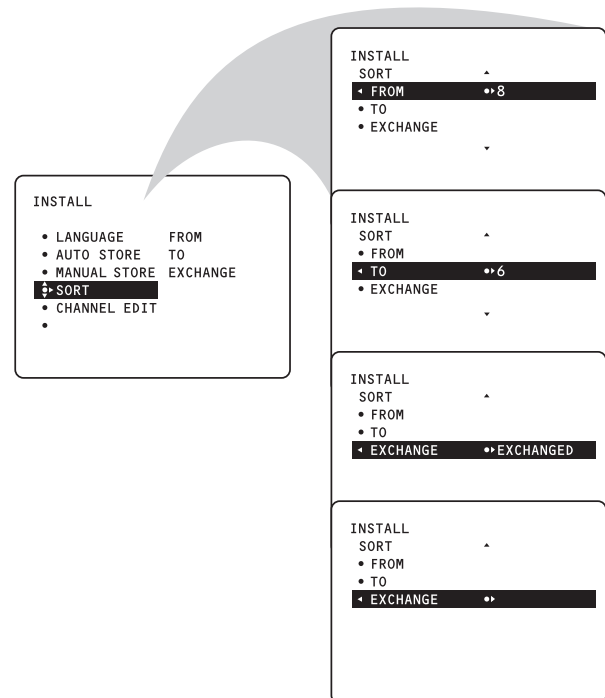

Using the Menus: Install

Editing Channels

This feature allows you to edit or skip channels from the channel list that have bad or weak signals or channels that you do not watch often.

Note: Once a channel is skipped, you cannot select it with the CH – or + key. You can only access the channel with the digit keys.

- 1 Select **CHANNEL EDIT** in the **INSTALL** menu.
- 2 Press the cursor right to enter the channel list.
- 3 Select the channel you want to skip with the cursor up/down.
- 4 Press the cursor right to skip the selected channel.

The message **SKIPPED** is displayed.

- 5 Press the cursor up/down to select another channel and repeat step 4.
- 6 Press the cursor left or the **MENU** key to return to the **INSTALL** menu or the **OSD** key to switch the menu off.

*Note: To add back channels to the list, repeat steps 1-4 and press the **OSD** key to switch the menu off.*

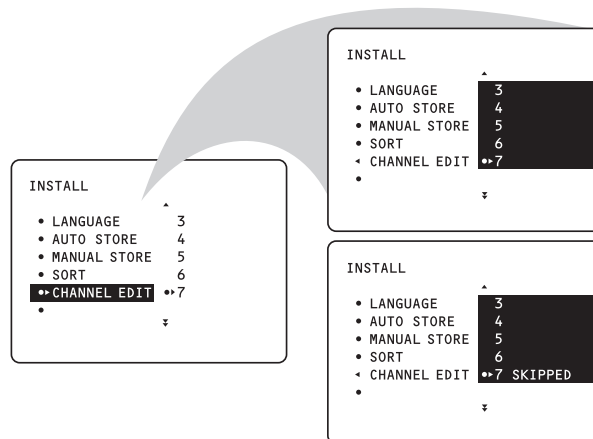

Naming Channels

It is possible to assign a name to a TV channel. This feature allows you to enter a name or modify an existing name of a channel, including peripherals.

Note: Even when you have selected another language in the LANGUAGE menu, only the English language character set is offered to enter names to the TV channels stored.

- 1 Select a TV channel or peripheral you want to assign a name or modify the existing name.
- 2 Select **NAME** in the **INSTALL** menu.
- 3 Press the cursor right to enter the menu.
- 4 Key in the selected character with the cursor up/down.
- 5 Move to the next character with the cursor right and key in the next character. You can key in up to a maximum of five characters.
- 6 Press the **MENU** key to store the named channel.

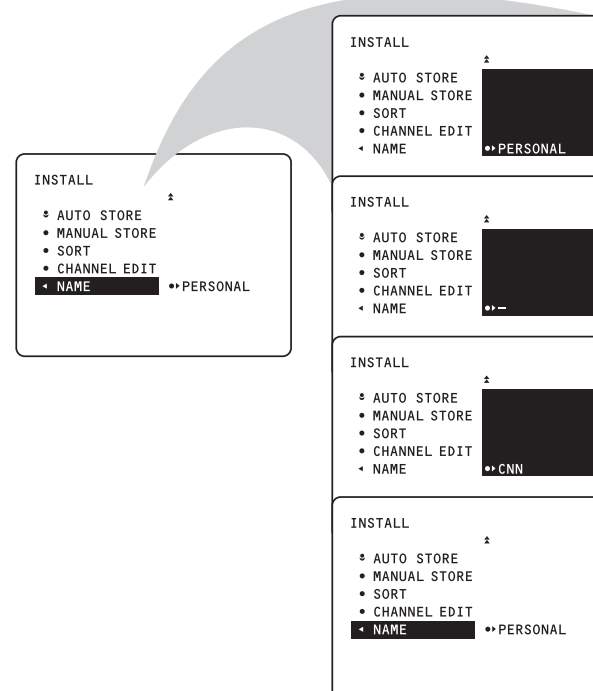

Using the Menus: Picture

Accessing the Menu

- 1 Press the **MENU** key to display the main menu.
- 2 Select **PICTURE**.
- 3 Press the cursor right to access the **PICTURE** submenu.
- 4 Use the cursor in the up/down directions to select an item.
- 5 Use the cursor in the left/right directions to make adjustments or settings.
- 6 Press the **MENU** key to return or press the **OSD** key to switch the menu off.

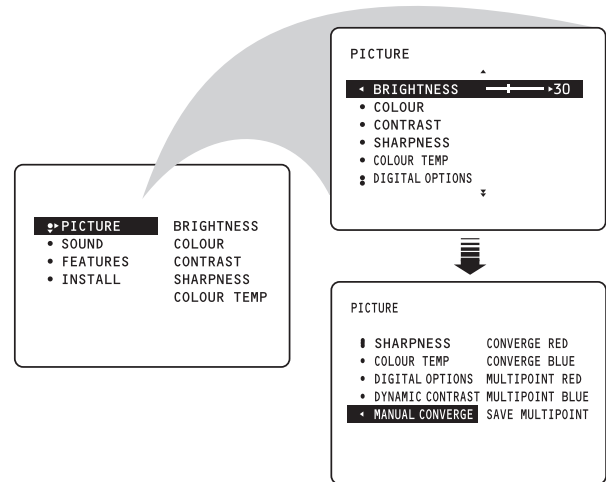

Picture Menu Items

Brightness

Allows you to adjust the brightness levels of the picture.

Colour

Allows you to adjust the colour saturation of the picture.

Contrast

Allows you to adjust the contrast levels of the picture.

Sharpness

Allows you to adjust the edge definition of the picture to improve details.

Hue (only with NTSC signals)

Allows you to adjust the colour mix of the picture.

Colour Temperature

Offers the options **Normal**, **Warm** and **Cool**. Make your selection with the cursor left/right. **Normal** keeps whites white. **Warm** makes whites reddish. **Cool** makes whites bluish.

Digital Options

Digital Scan includes **100Hz** plus **Digital Scan**, which together eliminate picture flickering and line jitter, offering a stable picture for relaxed viewing (no eye strain). **100Hz** offers field flicker reduction. Progressive doubles the number of visible picture lines per field by displaying all picture frame lines at once. This minimizes the visibility of the scan lines. Auto detects the input signal and provides the appropriate mode for the best picture performance. Choose **Digital Scan** for PAL 50Hz signals and **Progressive Scan** for NTSC 60Hz signals.

Dynamic Contrast

Automatically makes the contrast in the darker and the brighter picture areas more noticeable as the image on screen changes. Normally, select **MED**. In certain circumstances it may be preferable to select **MIN**, **MAX** or **OFF**.

IntelliSense

When activated, automatically adjusts picture convergence in 20 seconds or less.

Manual Converge

Allows you to make additional picture convergence adjustments to suit personal preferences to further fine-tune the picture.

Note: The picture settings Brightness, Colour, Contrast, Sharpness (Hue) and Colour Temperature are stored separately for channels 0-11 and for the external sources.

Using the Menus: Picture

Using Auto IntelliSense®

Your projection TV has three colour projection tubes: one for red, one for green, and one for blue. When mixed in proper proportion, the beams of light coming from the tubes can produce any colour. To create a clear picture, however, these colour beams must be precisely aligned. This alignment is called *convergence*. Bumps and vibrations, moving the set, or the presence of magnetic fields can cause the colour beams to become improperly aligned, or misconverged, resulting in a fuzzy picture. Using the Auto IntelliSense® feature, you can automatically adjust convergence in 20 seconds or less.

Note: Allow the TV to warm up for 20 minutes before using Auto IntelliSense®.

Activating Auto IntelliSense® Through the Onscreen Menu

- 1 Select **INTELLISENSE** in the **PICTURE** menu.
- 2 Press the cursor left or right to activate Auto IntelliSense®
Picture convergence will be adjusted automatically in 20 seconds.

Activating Auto IntelliSense® Using the TV Key

With the TV on, press the **INTELLISENSE** key on the front of the TV. Picture convergence will be adjusted automatically in 20 seconds.

*Note: You can also manually adjust picture convergence to suit your personal preferences or to further fine-tune the picture. See the next section on using the **MANUAL CONVERGE** controls.*

Using Manual Converge: Converge Red/Blue

Using the Auto IntelliSense® feature, you can automatically adjust convergence in 20 seconds or less (see the previous page). Also, if you desire, you can use the Manual Converge controls to make additional convergence adjustments to suit your personal preferences or to further fine-tune the picture.

Note: Allow the TV to warm up for 20 minutes before adjusting convergence.

- 1 Select **MANUAL CONVERGE** in the **PICTURE** menu.
- 2 Press the cursor down and select either **CONVERGE RED** or **CONVERGE BLUE**.

*Note: If various images in the picture have red outlines, select **CONVERGE RED**. If various images in the picture have blue outlines, select **CONVERGE BLUE**.*

- 3 Use the cursor right, left, up or down to adjust the cross hair until the colour outline is gone. The adjustment is automatically saved in the TV's memory when you exit the adjust mode.
- 4 Press the **MENU** key to return or the **OSD** key to switch the menu off.

Check the TV picture. If any colour outlines remain around the images, use the **MULTIPOINT RED** (for red outlines) or **MULTIPOINT BLUE** (for blue outlines) control. See the next section for instructions for using those controls.

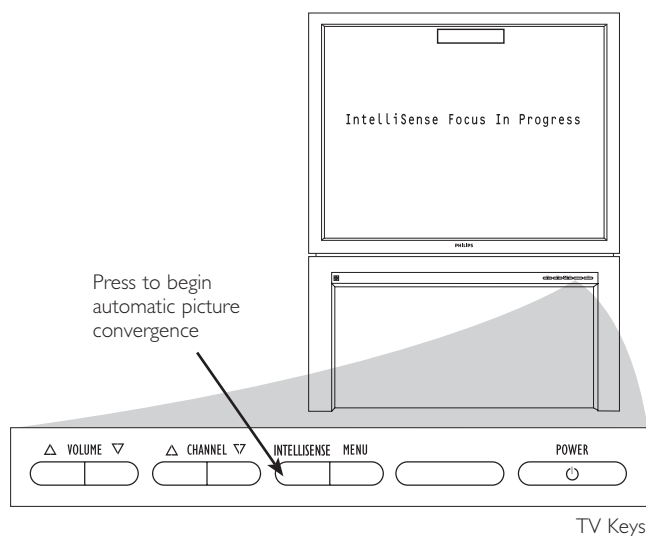
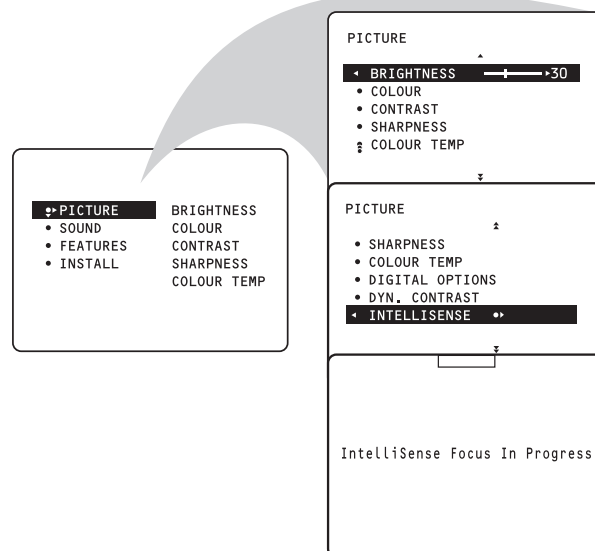

TV Keys

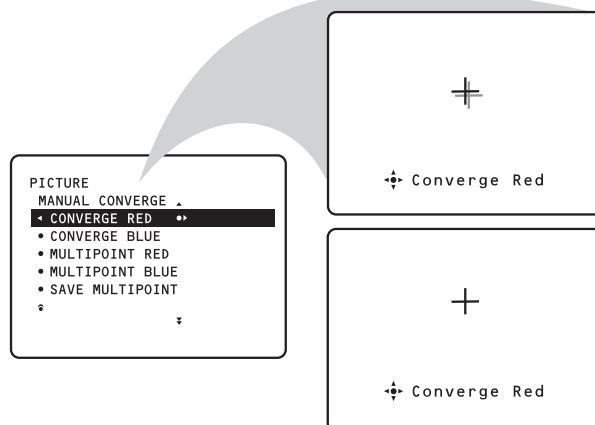

Using Manual Converge: Multipoint Red/Blue

The Multipoint Red/Blue convergence controls allow you to adjust picture convergence at specific points on the TV screen.

Note: Allow the TV to warm up for 20 minutes before adjusting convergence. Adjust Converge Red or Converge Blue before using the Multipoint Red/Blue controls. See the previous page.

- 1 Select **MULTIPOINT RED** or **MULTIPOINT BLUE** in the **MANUAL CONVERGE** menu.
- 2 Press the cursor right to enter navigate mode.
- 3 Use the cursor left, right, up or down to move to a cross hair that has a colour outline.
- 4 Press the **OSD** (Status/Exit) key to enter adjust mode.
- 5 Use the cursor left, right, up or down to adjust the cross hair until the colour outline is gone.
- 6 Press the **OSD** key to return to navigate mode.
- 7 Repeat steps 3-6 until all misaligned cross hairs have been adjusted. Then press the **MENU** key.
- 8 For your multipoint adjustments to be stored in the TV's memory, you must activate **SAVE MULTIPOINT**.

*Note: If you are not satisfied with the adjustments you just made and want to start over, you can use the **UNDO MULTIPOINT** control. This control allows you to undo the adjustments, but only if you use it before saving.*

To save your multipoint adjustments: Select **SAVE MULTIPOINT** and press the cursor left or right.

To undo your multipoint adjustments: Select **UNDO MULTIPOINT** and press the cursor left or right.

To restore the TV's picture convergence to factory settings, select **RESTORE FACTORY** and press the cursor left or right.

- 9 Press the **MENU** key to return or the **OSD** key to switch the menu off.

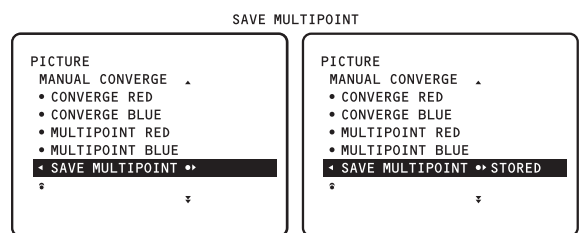
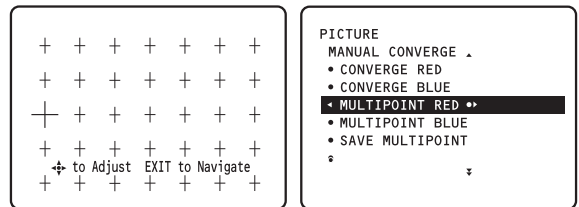
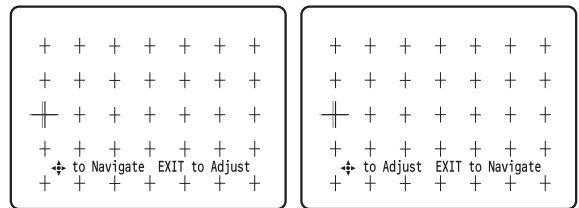
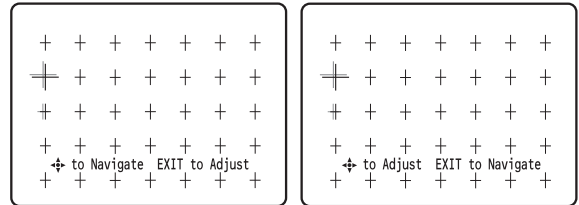
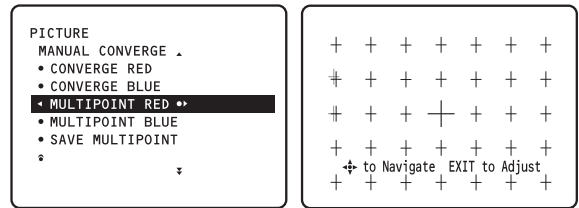

OR

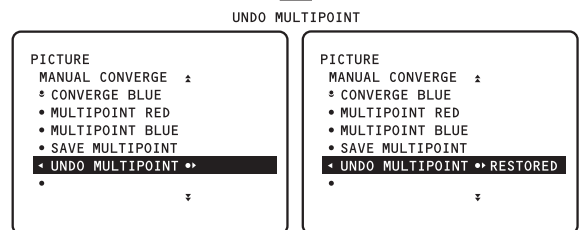

OR

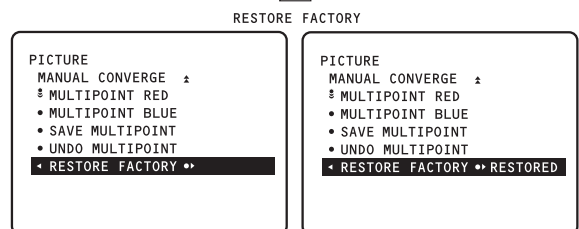

Using the Menus: Sound

Accessing the Menu

- 1 Press the **MENU** key to display the main menu.
- 2 Select **SOUND** with the cursor down.
- 3 Press the cursor right to access the **SOUND** submenu.
- 4 Use the cursor in the up/down directions to select an item.
- 5 Use the cursor in the left/right directions to make adjustments or settings.
- 6 Press the **MENU** key to return or press the **OSD** key to switch the menu off.

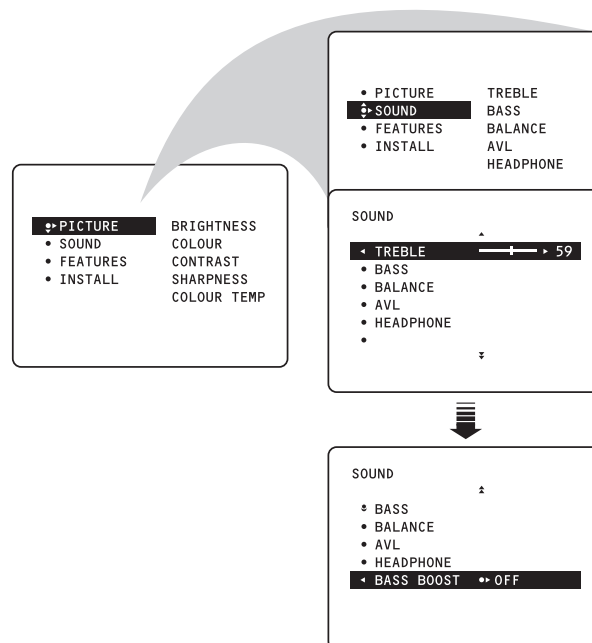

Sound Menu Items

Treble

Attenuates or amplifies the high-frequency response of the audio output signal.

Bass

Attenuates or amplifies the low-frequency response of the audio output signal.

Balance

Adjusts the balance of the right and left speaker's sound output.

AVL (Automatic Volume Leveller)

Automatically controls the volume level to avoid excessive level differences, especially when switching to another channel or during commercial breaks.

Headphone

Allows you to adjust the volume and balance of the headphone.

- 1 Select **HEADPHONE**.
- 2 Press the cursor right.
- 3 Select **VOLUME** or **BALANCE** with the cursor up/down.
- 4 Press the cursor left/right to adjust.
- 5 Press the **MENU** key to return.

Using the Menus: Features

Accessing the Menu

- 1 Press the **MENU** key to display the main menu.
- 2 Select **FEATURES** with the cursor down.
- 3 Press the cursor right to access the **FEATURES** submenu.
- 4 Use the cursor in the up/down directions to select an item.
- 5 Use the cursor in the left/right directions to make settings.
- 6 Press the **MENU** key to return or press the **OSD** key to switch the menu off.

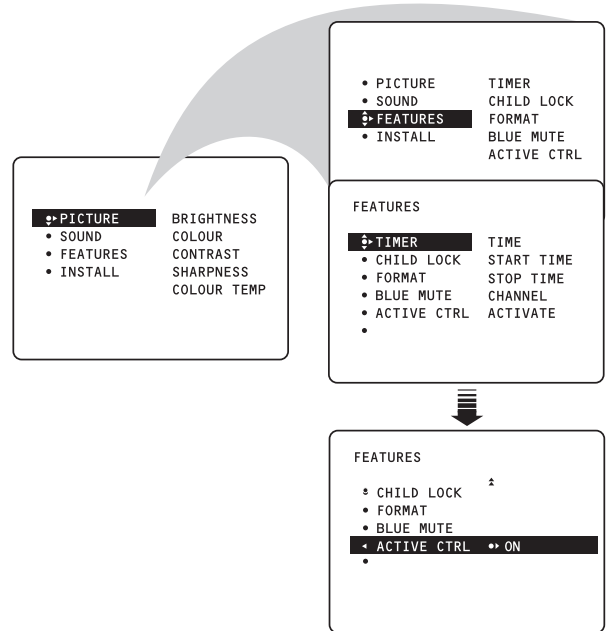

Activating the Timer

The Timer feature allows you to set the timer to switch to another channel at a specified time while you are watching a channel or when the TV is in standby mode. You can also set the TV to switch off automatically at a specific time by setting a Stop Time.

- 1 Select **TIMER** in the **FEATURES** menu.
- 2 Press the cursor right to enter the Timer.

Setting the Timer

- 1 Press the cursor right again to enter **TIME** mode.
- 2 Key in the current time with the digit keys. You must use 24-hour or military time. For example: 2:15 p.m. is 14:15.

If you entered an incorrect digit: Complete the actual time with arbitrary numbers, then start again.

- 3 Press the cursor left to exit **TIME** mode.

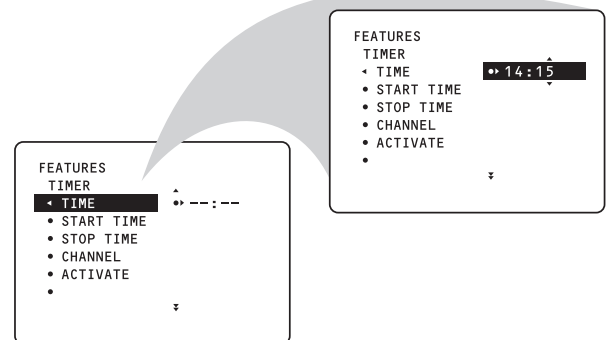

Setting Start Time

- 1 Select **START TIME** with the cursor down.
- 2 Press the cursor right to enter the **START TIME** mode.
- 3 Key in the time you want the programme to switch on.
- 4 Press the cursor left to exit **START TIME** mode.

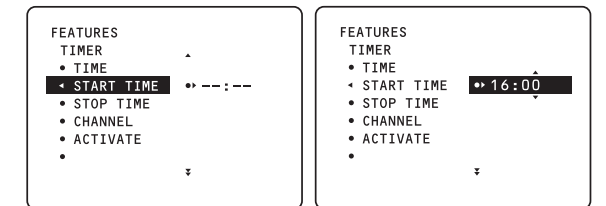

Setting Stop Time

- 1 Select **STOP TIME** with the cursor down.
- 2 Press the cursor right to enter the **STOP TIME** mode.
- 3 Key in the time you want the programme to be switched off.
- 4 Press the cursor left to exit **STOP TIME** mode.

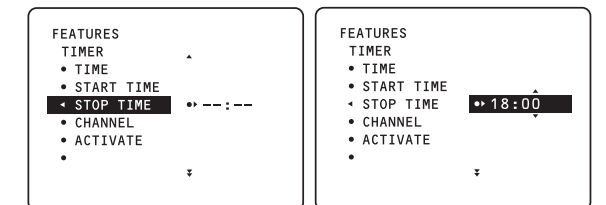

Selecting the Channel

- 1 Select **CHANNEL** with the cursor down.
- 2 Select the channel you want to switch to.

Activating the Timer

- 1 Select **ACTIVATE** with the cursor down.
- 2 Press the cursor right to enter the **ACTIVATE** mode to activate the timer.

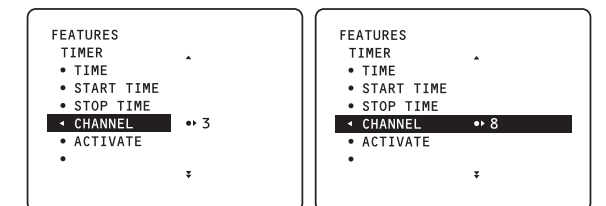

Using the Menus: Features

- Using the cursor right, select **ONCE** or **DAILY**, according to if you want to activate the timer on the selected channel and the selected time every day or only once.

Displaying the Time

- Select **DISPLAY** with the cursor down.
- Press the cursor right to select **ON** or **OFF**, according to if you want to display the current time on the TV screen or not.
- Press the **MENU** key to return or the **OSD** key to switch the menu off.

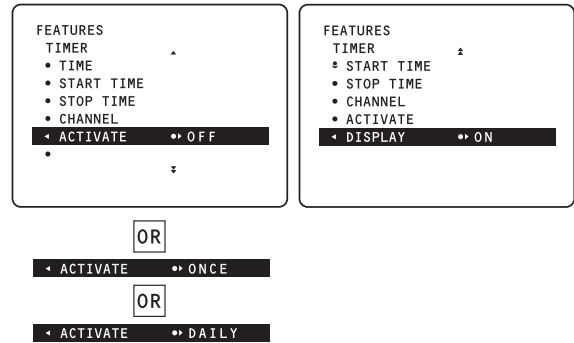

Activating the Child Lock

The Child Lock feature allows you to lock channels to prevent children from watching certain programmes.

Entering the Access Code

- Select **CHILD LOCK** in the **FEATURES** menu.
- Press the cursor right to enter the **ACCESS CODE**.
- Key in the access code 0711 (the default access code). A message **INCORRECT** will appear.
- Key in access code 0711 a second time. The message **CORRECT** will appear and make the Child Lock menu accessible.

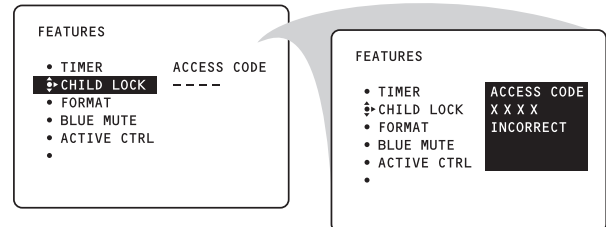

Changing the Access Code

- Select **CHANGE CODE** to enter an access code of your choice.
- Press the cursor right to enter the **CHANGE CODE** mode.
- Key in the access code of your choice and confirm it again. The message **CORRECT** will appear.



Activating the Child Lock

- Select **LOCK CHANNEL** in the **CHILD LOCK** menu.

Note: Enter the access code if requested. See above.

- Press the cursor right to enter the **LOCK CHANNEL** mode.
- Use the cursor up/down to select the channel you want to lock.
- Press the cursor right to lock the channel. A keylock symbol will appear beside the locked channel.

From now on the locked channel(s) can be accessed only via the remote control.

- Repeat steps 1-4 to unlock a locked channel.

To clear all locked channels at once, select **CLEAR ALL** in the **CHILD LOCK** menu and press the cursor right. The message **CLEARED** will appear.

- Press the **MENU** key to return or the **OSD** key to switch the menu off.

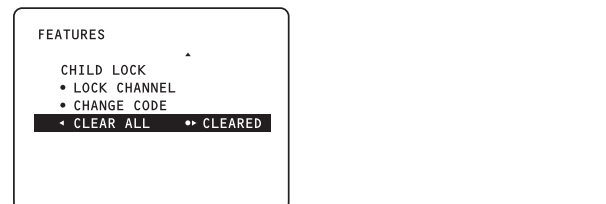
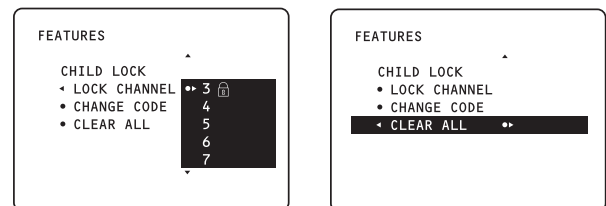
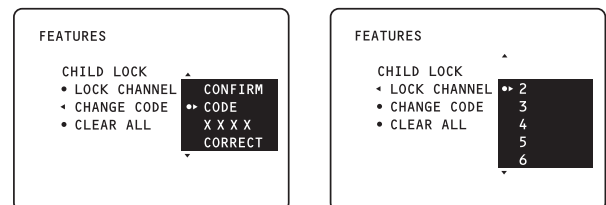
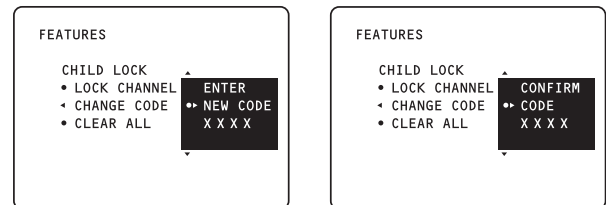

Selecting the Screen Format

The TV's Screen Format options allow you flexibility in viewing video sources. Select a screen format using the cursor up/down keys or the onscreen menu. To use the onscreen menu:

- 1 Select **FORMAT** in the **FEATURES** menu.
- 2 Press the cursor right repeatedly to cycle through the different screen formats and select your desired format. The options vary by input source (see specifics to the right):
 - **4:3** format displays the 4:3 picture using the full surface of the screen.
 - **AUTO** format make the picture fill the screen as much as possible.
 - **EXPAND 4:3** format expands movie images recorded in the letterbox format. The black bars at the top and bottom of the screen are expanded, thus filling the entire TV screen.
 - **COMPRESS 16:9** allows you to show widescreen, high-definition video sources as they were intended for a more natural picture. Black bars are displayed at the top and bottom of the screen.

Switching Blue Mute on

The Blue Mute feature indicates to you the absence of signal in the transmission when BLUEMUTE is activated.

- 1 Select **BLUE MUTE** in the **FEATURES** menu.
- 2 Press the cursor right to select **ON** to activate the blue mute feature.
- 3 Press the **OSD** key to switch the menu off.

Switching Active Control™ on

Turn Active Control™ on using the remote control **ACTIVE CTRL** key or the onscreen menu. To use the onscreen menu:

- 1 Select **ACTIVE CTRL** in the **FEATURES** menu.
- 2 Press the cursor right to select **ON** to activate automatic control of Sharpness and Noise Reduction.
- 3 Press the **OSD** key to switch the menu off.

Note: Should your remote control be lost or broken, you can still change some of the basic picture and sound settings with the keys on the front of the TV. See page 5.

For AV1, CVI, AV2, or AV3 Sources:

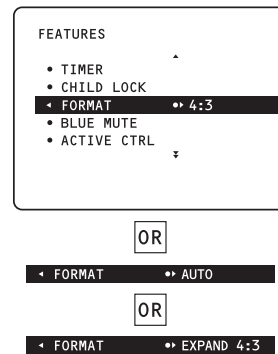

For AV4 and AV5 1080i Sources:

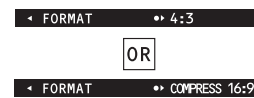

For AV4 and AV5 480p or 576p Sources:

No picture format options are available through the TV. Control the screen format at the source (DVD player or digital set-top box).

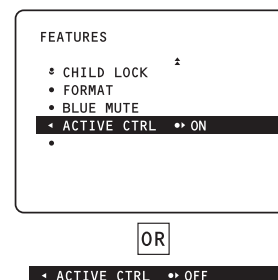
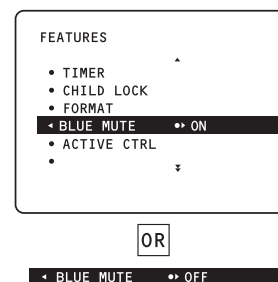

Adding Channels to the Surf List

You can select a list or series of previously viewed channels with the SURF key. This feature allows you to switch between different TV programmes that currently interest you. You can have up to 10 channels in the SURF list. Five channels are shown in the list at one time. Cursor down/up as necessary to see all the channels in the list.

- 1 Select a channel you want to add to the Surf list.
- 2 Press the **SURF** key.
- 3 Cursor right to add the selected channel to the Surf list. The channel is added when "delete?" appears, representing the next available action.
- 4 Repeat steps 1-3 to add more channels to the Surf list.
- 5 Press the **OSD** key to switch the menu off.
- 6 Press the **SURF** key repeatedly to cycle through channels.

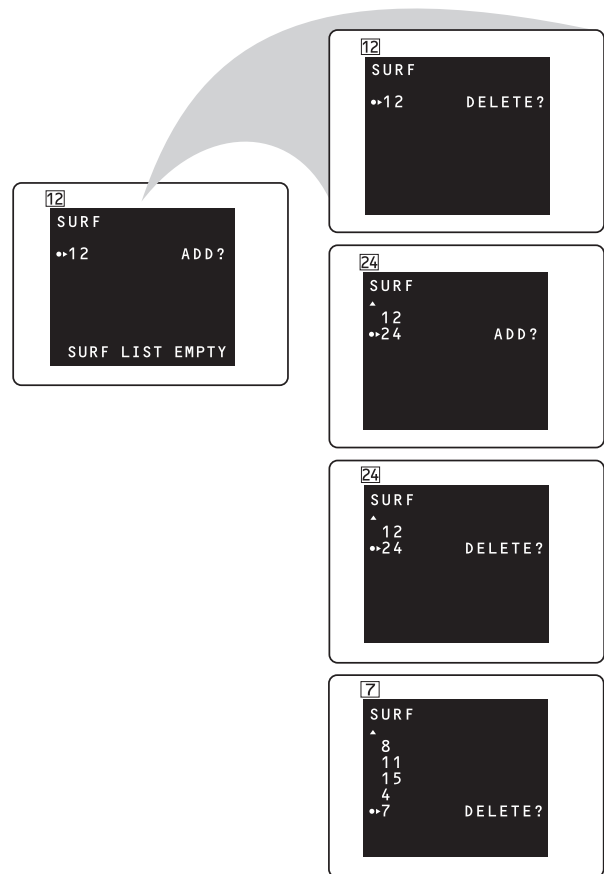

Deleting Channels to the Surf List

- 1 Press the **SURF** key.
- 2 Press the **SURF** key again as many times as necessary to select the channel you want to delete from the Surf list.
- 3 Cursor right to delete the channel from the list.
- 4 To delete more channels, repeat the steps above.



Using Smart Picture and Smart Sound

The Smart Picture feature offers you a choice of five picture settings: Personal, Rich, Natural, Soft and Multimedia. Smart Sound offers you a choice of four sound settings: Personal, Voice, Music and Theatre.

Press the **SMART**  Picture or **SMART**  Sound key on the remote control repeatedly to cycle through the settings and select your desired mode.

Note: The values shown in the Picture/Sound Setting diagrams are sample values only. Your television's values may vary and display different numbers.

Smart Picture Options

Personal

Picture settings are based on your preference.

Rich

Emphasizes very vibrant colours. This option is desirable for AV mode in a brightly lighted room.

Natural

Emphasizes all settings equally.

Soft

Emphasizes "warm" colours. This option is desirable for a dimly lighted room and gives a cinema-like effect when the light is switched off.

Multimedia

Emphasizes "soft" colours. This option is desirable for playing computer games.

Smart Sound Options

Personal

Sound settings are based on your preferences.

Voice

Brings voices to the forefront, emphasizing them. Moves music to the background.

Music

Emphasizes music over voices.

Theatre

Provides a balance between voices and music.

*Note: The **PERSONAL** settings are the ones that you make using the **PICTURE** or **SOUND** menus. These are the only Smart Picture and Smart Sound settings that can be changed. All others are set at the factory.*

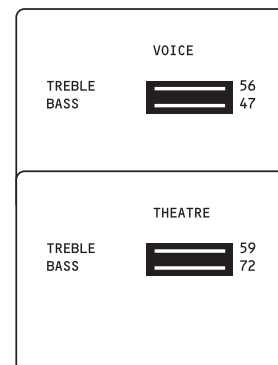
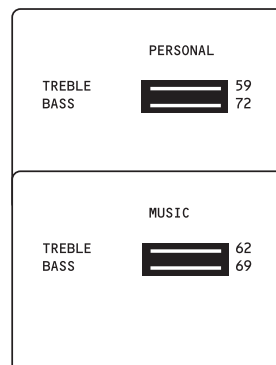
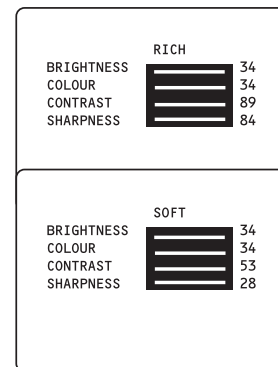
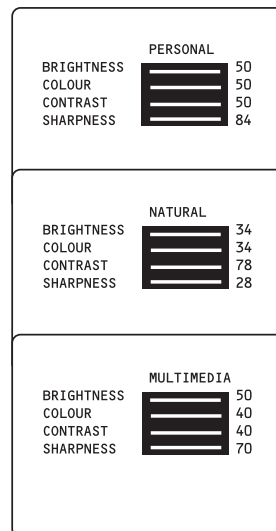

Using Teletext (if provided)

Many TV channels broadcast information via teletext. Each channel that broadcasts teletext transmits a page with information on how to use its teletext system. Look for the teletext page with the main index (usually p. 100).

Depending on the TV channel, teletext is transmitted in different systems. The colours used in the options line correspond with the colour keys of your remote control.

About Teletext



Easy Text considerably reduces the waiting time (on condition that the teletext broadcast of the particular TV channel is received for at least half a minute) by:

- a direct selection of previous and following pages that are in transmission and of the pages referred to in the options line at the bottom of the teletext screen;
- a habit watcher list: frequently used pages are put automatically in a list of preferred pages so that they are immediately available;
- the precapturing of the page numbers referred to in the displayed page; and
- the precapturing of all the subpages.

Switching Teletext on and off

- 1 Press the  key to switch the teletext on.

The main index page appears on the screen together with two information lines at the top and one option line at the bottom of the screen.

- 2 Press the  key again to overlay the teletext page on the TV programme.
- 3 Press the  key once again to switch the teletext off.

Selecting a Teletext Page

With the digit keys

Enter the desired page number with the digit keys.

The page counter seeks the page or the page appears immediately when the page number has been stored in the memory.

A message appears when you have entered a nonexistent or incorrect page number. Page numbers beginning with 0 or 9 do not exist. Choose another number.

With the option line

Use the colour keys – which correspond to the coloured options at the bottom of the screen – to select the desired subject.

If the option line is not on the screen, press the selected colour key TWICE.

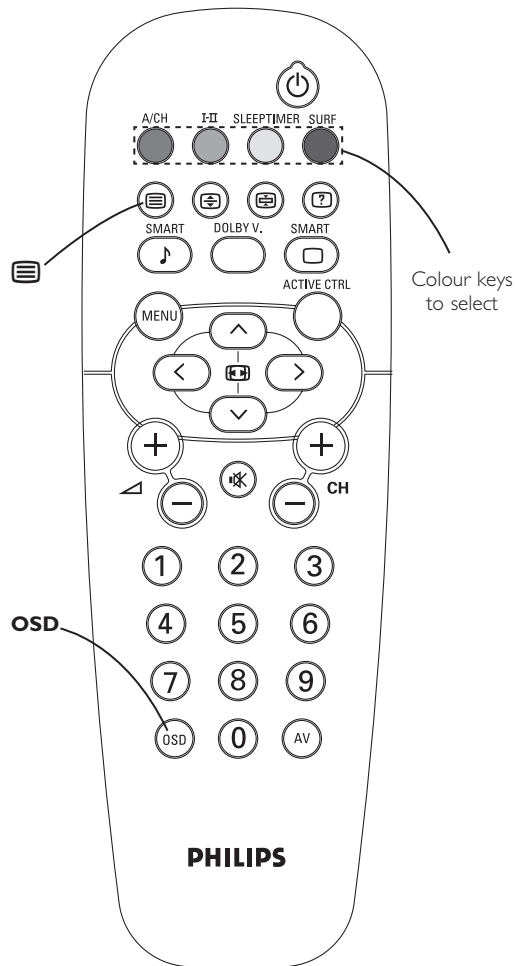

Quickly Running Through the Teletext Pages

Press the cursor up/down or the CH +/- keys to run through the previous or the following pages.

Selecting the Index Teletext Page

Press the OSD key to return to the main index (usually p. 100).

Selecting Subpages

When a selected teletext page consists of different subpages, one of the subpages appears on the screen.

Arrows in front of the page number indicate that other subpages are available.

The other subpages can be selected in two ways:

With the cursor left/right

The other subpage numbers appear in white as soon as the transmission has found them. They are stored in the memory so that they are available while the teletext page is on screen.

Use the cursor left/right to select the previous or the following subpage.

Using Special Teletext Functions

Enlarge

Press  repeatedly to display the upper part and the lower part, and then to return to the normal page size. When the upper part is displayed, you can scroll the text, line by line using the cursor up/down.

Reveal

Press  to reveal/conceal the hidden information, such as solutions to riddles and puzzles.

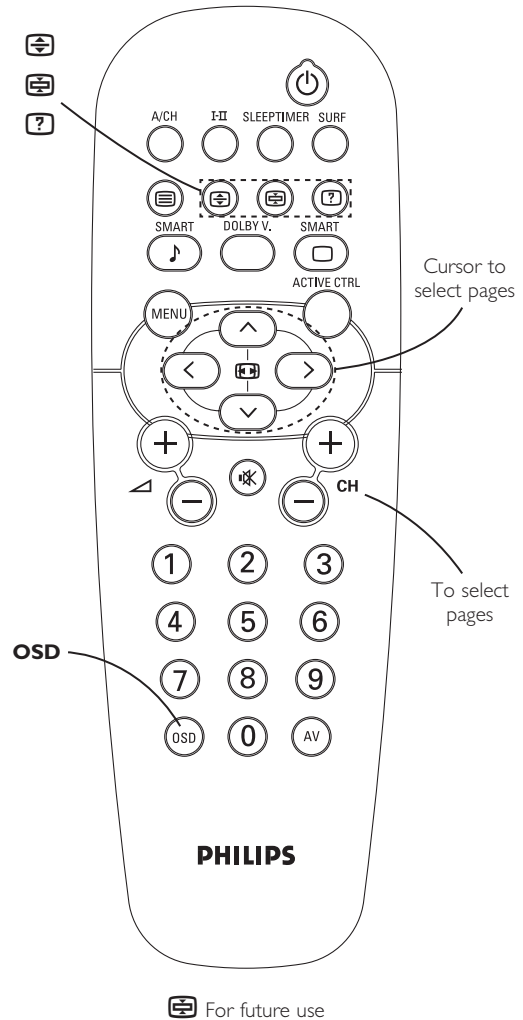

Connecting Peripheral Equipment

You can connect a wide range of video and audio equipment to your TV in various ways. This page and the next one provide an overview of signal compatibilities and the types of equipment you can connect to the sockets. Connection examples follow on subsequent pages. As necessary, also refer to the handbook for peripheral equipment.

Overview: Standard Inputs/Outputs

1 ANTENNA IN 75Ω socket

- compatible with the broadcast standard in your area. Use to connect radio-frequency (RF) signals from VHF/UHF antennas or a cable system.

2 YPbPr (component video input [CVI] sockets)

- compatible with 480i and 576i signals. Use to connect equipment having component video outputs, such as DVD players, laser-disc players, video-game players, satellite receivers or other equipment. Use the INPUT-AV 1 L(left) and R(right) AUDIO sockets for sound connections.

3 S-VIDEO (super video) sockets

- compatible with 480i and 576i signals. Use to connect peripherals having Super VHS (S-VHS) outputs, such as VCRs, DVD players, laser-disc players, video-game players, satellite receivers or other equipment.

4 VIDEO (composite) sockets (INPUT-AV 1, INPUT-AV 2 and TV's side socket panel [AV3])

- compatible with 480i and 576i signals. Use to connect peripherals having composite video outputs, such as VCRs, video-game players or other equipment.

5 AUDIO inputs (INPUT-AV 1, INPUT-AV 2 and TV's side socket panel [AV3])

- use to connect from the audio output sockets on VCRs, DVDs or other peripherals.

6 MONITOR OUT (VIDEO/AUDIO)

- use to connect to a VCR to record programmes from the TV. Or use the AUDIO outputs to connect to an audio hi-fi system.

7 Headphone socket (stereo, 3.5 mm)

- use to connect headphones for personal listening. The headphone impedance must be between 8 and 4000 Ohms.

8 SUBWOOFER Output

- use to make optional connection to an external powered subwoofer.

Overview: High-definition Inputs

The AV4 and AV5 sockets allow you to connect digital equipment with 1080i/480p (60Hz) or 576p (50Hz) signal output.

9 AV4

- use to connect digital equipment with a 1080i/480p (60Hz) or 576p (50Hz) signal output, such as digital set-top boxes or DVD players with progressive-scan capability. You can connect equipment with YPbPr component video or RGB outputs to the AV4 sockets. H and V Sync connections may

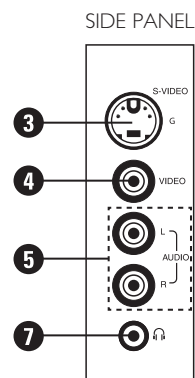

Note: The side panel is AV3.

REAR OF TV

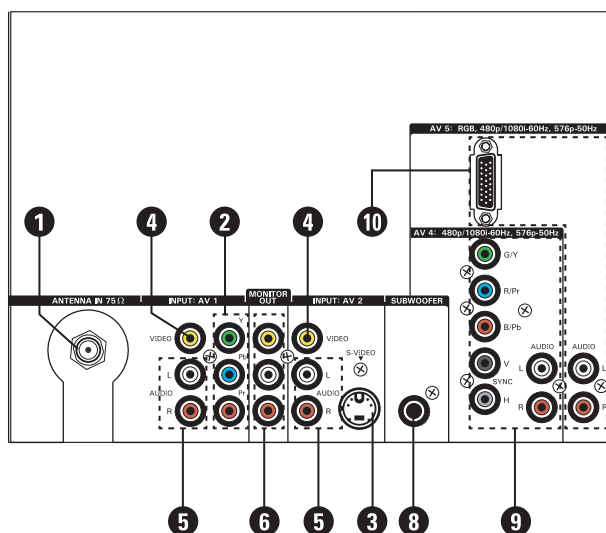

or may not be required for RGB connections. Use the AV4 L(ef) and R(ight) AUDIO sockets for sound connections.

See the handbook for the digital equipment you are connecting.

10 AV5

- use to connect digital equipment with a 1080i/480p (60Hz) or 576p (50Hz) signal output, such as digital set-top boxes or DVD players. The AV5 socket accepts a DB15 connector. Note, however, that adaptors can also be used to connect from component video output to this DB15 socket. Use the AV5 L(ef) and R(ight) sockets for sound connections.

See the handbook for the digital equipment you are connecting.

High-definition Inputs – Video Synchronizing Reference		
Input	Video Description	Accepts Video Sync according to:
AV4, AV5	480p (60Hz)	EIA/CEA-770.2-C
	1080i (60Hz)	EIA/CEA-770.3-C
	576p (50Hz)	ITU-R BT.1358

AV4 and AV5 Digital High-definition Inputs

When you have digital equipment with 1080i or 480p signal output (60Hz) or 576p signal output (50Hz), connect it to the **AV4** or **AV5** inputs on your TV. Examples of such equipment are digital set-top boxes and progressive-scan DVD players.

Connecting to AV4

Connect digital equipment with component video output (usually labeled **Y-Pb-Pr**) or with **RGB** output (phono-type connectors) to the **AV4** inputs for video and audio left and right. Also connect to the **H** and **V SYNC** inputs on the TV if required for your digital equipment.

Note: The AV4 sockets are compatible with some digital equipment having RGB outputs with “sync on green” or RGB with “separate H and V sync.” Output standards for digital equipment, however, may vary by manufacturer. No industry standards have been established for HD television RGB signal systems, timing, synchronization, and signal strengths. If the digital equipment you want to connect to your TV offers both component video and RGB outputs, component video is the suggested connection to use. See the handbook for the digital equipment.

Connecting to AV5

Connect digital equipment with **RGB** or **Y-Pb-Pr** output to the **AV5** inputs for video and audio left and right. A DB15 cable or adaptor cable with a DB15 connector is required.

Note: The AV5 input cannot be used to connect a computer or any other VGA device.

Notes regarding connecting to either AV4 or AV5:

- For connections to either **AV4** or **AV5**, be sure the TV's colour-space setting matches the output (**Y-Pb-Pr** or **RGB**) of the digital equipment you have connected to the **AV4** or **AV5** inputs. See instructions for setting the TV's colour space on page 22.
- See the handbook for the high-definition equipment.
- If you notice scrolling images, wrong colours or no colour, no picture or even combinations of these on your screen, check to see if the connections have been done properly.

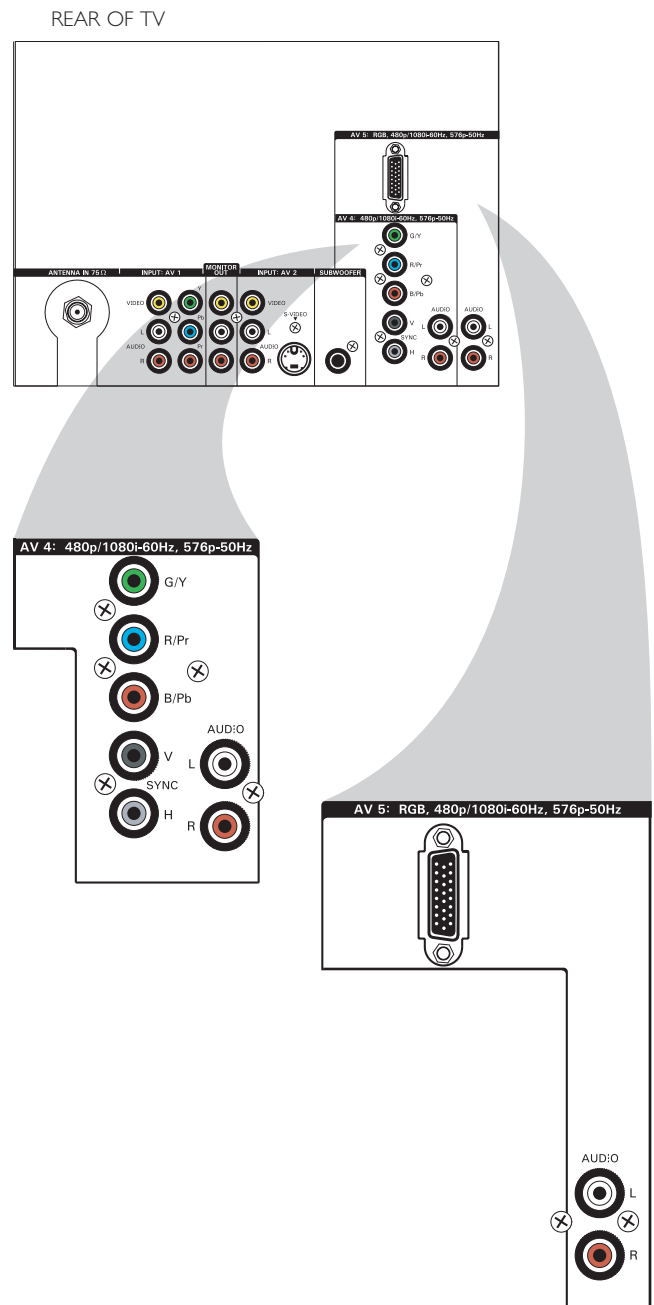

Connecting Peripheral Equipment

Setting the AV4 and AV5 Colour Space

The term *colour space* refers to how colours are defined and appear on your TV. When making connections to the **AV4** or **AV5** sockets, you will need to be sure the TV's colour space is set to match the output of the peripheral you have connected.

- 1 Press the **AV** key on the remote control as many times as necessary to select the high-definition input you desire, **AV4** or **AV5**.
- 2 Press the **MENU** key to display the menu.
- 3 Select **INSTALL** with the cursor down.
- 4 Press the cursor right to enter the **INSTALL** menu.
- 5 Cursor down until the high-definition input (**AV4** or **AV5**) is selected.
- 6 The current colour-space setting appears to the right of **AV4** or **AV5**. To change the setting, cursor left or right.
- 7 Press the **OSD** key to switch the menu off.

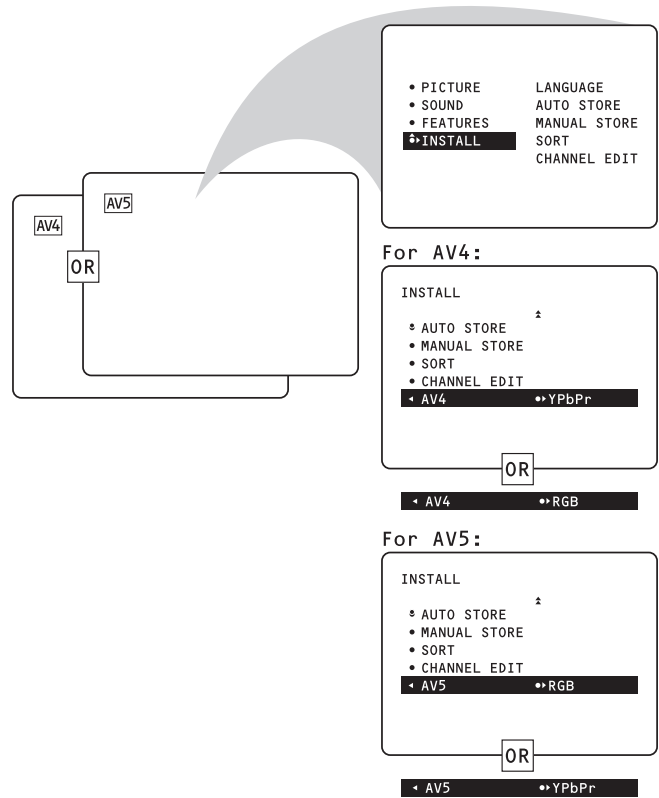

Selecting Connected Equipment for Viewing

Equipment Connected with an Aerial Cable Only

Select the channel number under which you have stored the test signal with the digit keys.

Equipment Connected to the back or to the side of the TV (AV3)

Press the **AV** key repeatedly to select **AV1**, **CVI**, **AV2**, **AV3**, **AV4** or **AV5** according to where you have connected your equipment at the back or the side of your TV.

Select **CVI** to view the playback of DVD discs if you used the **INPUT-AV 1** component video input sockets (**Y-Pb-Pr** and **AUDIO L [mono]** and **R** inputs).

TV Channels

Enter the channel number of the TV channel you want to watch with the **digit** or **CH +/-** keys.

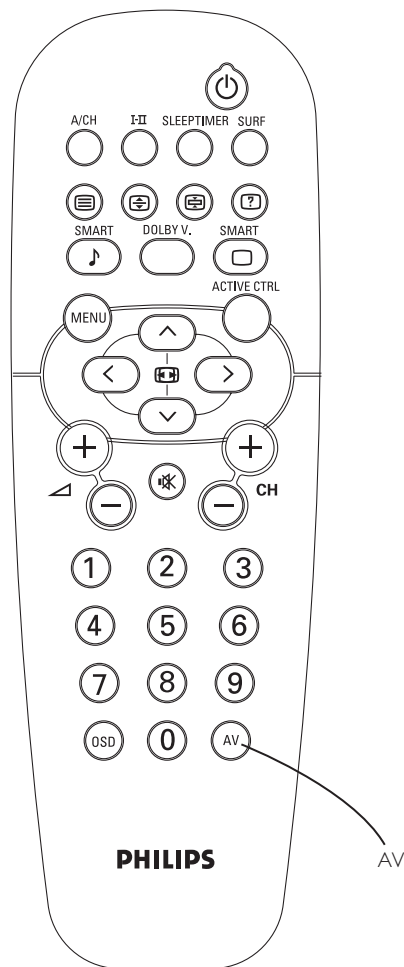

WARNING Concerning Stationary Images on the TV Screen:

Do not leave stationary or “letterbox” images on screen for extended periods of time. This can cause uneven picture-tube aging.

Normal use of the TV should involve the showing of pictures that contain constantly moving and changing images that fill the screen. Be careful not to leave nonmoving images on screen for extended periods of time or to display the same images on screen too frequently, because subtle ghost images can be left on the picture tubes. Avoid showing the same stationary images more than 15 percent of your total viewing in any one week. Sources of stationary images may be DVD discs, laser discs, video games, CD-i discs, videotapes, digital television boxes, broadcast channels, cable channels, satellite channels and others.

Here are some examples of stationary images (this is not an all-inclusive list; you may encounter others in your viewing):

- **DVD menus** – listings of DVD disc content.
- **“Letterbox” black borders** – black bars shown along the edges of the picture when a widescreen (16:9) movie is played on TV.
- **Video-game images and scoreboards.**
- **Television station logos** – present a problem if they are bright and stationary; moving or low-contrast graphics are less likely to cause uneven aging of the picture tube.
- **Stock-market tickers** – presented at the bottom of the TV screen.
- **Shopping channel logos and pricing displays** – bright and shown constantly or repeatedly in the same location on the TV screen.

All picture tubes age with use, with their light output diminishing over time. But by maintaining normal use—mixing television picture types – you will create conditions for the tubes to age at an even rate. The result will be a TV picture that is evenly bright over the entire screen.

Placement of the TV

- See page 4.

Cleaning

- To avoid possible shock hazard, be sure the TV is unplugged from the electrical outlet before cleaning.
- Regularly dust the TV with a dry, nonscratching duster to keep the TV clean.
- When cleaning the TV, take care not to scratch or damage the screen surface. Avoid wearing jewelry or using anything abrasive. Do not use household cleaners. Wipe the front screen with a clean cloth dampened with water. Use even, easy, vertical strokes when cleaning.
- Gently wipe the cabinet surfaces with a clean cloth or sponge dampened in a solution of cool, clear water and a mild soap or detergent. Use a clean, dry cloth to dry the wiped surfaces.
- Occasionally vacuum the ventilation holes or slots in the back cover of the set.
- Never use thinners, insecticide sprays, or other chemicals on or near the cabinet, as they might cause permanent marring of the cabinet finish.

Tips

- Do not shift or move the set around when it is switched on. Unevenness in colour in some parts of the screen may occur.

End-of-life Disposal of the TV

Philips is paying much attention to making its products environmentally friendly. Your new TV contains materials that can be recycled and reused. Specialised companies can dismantle your discarded TV at the end of its life, concentrating on the reusable materials and minimising the amount of materials to be disposed. Please be sure to dispose of your old TV according to local regulations.

Disposal of Exhausted Batteries

The batteries supplied do not contain the heavy metals mercury and cadmium. Nevertheless, in many countries exhausted batteries may not be disposed of with your household waste. Please ensure you dispose of exhausted batteries according to local regulations.

Before Calling Service

Symptom	What to do
TV remote control does not work	<ul style="list-style-type: none"> • Check that the batteries are installed correctly. • Replace the batteries, if necessary. • Clean the remote control and the remote-sensor window on the TV. • Be no farther than 6 meters from the TV when using the remote control and aim the remote control toward the TV's remote-sensor window. • If the remote control still will not work, use the keys on the TV.
No power	<ul style="list-style-type: none"> • Check that the TV's power cord is plugged into the mains socket. If there is still no power, disconnect the plug. Wait for 60 seconds and reinsert the plug and then switch on the TV again. • See if the outlet is controlled by a wall switch. • If you are using an AC power strip, be sure the fuse on the power strip is not blown.
No picture	<ul style="list-style-type: none"> • Check the antenna connection at the rear of the TV to see if it is properly connected to the TV input terminal. • The broadcast station may be experiencing difficulty. Try another channel. • Adjust the contrast and brightness settings or select another picture setting with the Smart Picture key on the remote control. • If using peripheral equipment through the A/V inputs, be sure it is properly connected. • Be sure you have selected the correct signal source for viewing. • If you are attempting to view a picture from a progressive-scan-capable DVD player connected to the AV4 and AV5 sockets, be sure you have switched the DVD player to progressive-scan mode. • If you are using an HD receiver, be sure its output is set correctly (to HD or SD), based on the connection to the TV you have made.
Good picture but no sound	<ul style="list-style-type: none"> • Increase the volume. • Check that the TV is not muted; press the  key on the remote control. • When no signal is detected, the TV automatically switches off the sound. This is proper operation and does not indicate a malfunction. • Check the transmission system's sound settings on the set.
Good sound but poor colour or no picture	<ul style="list-style-type: none"> • Adjust the contrast and brightness setting or select another picture setting with the Smart Picture key on the remote control. • Check the transmission system's colour settings on this set.
Poor picture	<ul style="list-style-type: none"> • Poor picture quality sometimes occurs when an S-VHS camera or camcorder has been connected to the side panel (AV3) of the TV when another peripheral is connected to AV1 or AV2 simultaneously. In this case, switch off one of the other peripherals.
Snowy picture and noise	<ul style="list-style-type: none"> • Check the antenna connection.
Colour patch (unevenness)	<ul style="list-style-type: none"> • Switch off the TV by the mains power key. Wait for 20 minutes before switching on again. • Be sure you have made connections correctly. • If you have connected digital equipment to the AV4 and AV5 sockets, check the colour-space setting on the equipment or TV and change the setting on either if necessary. • Check to be sure the TV is not placed too near speakers or magnetic objects. • Adjust the TV's convergence.
Horizontal dotted lines	<ul style="list-style-type: none"> • This may be caused by electrical interference from appliances such as hair dryers or vacuum cleaners or other sources such as neon lights. Turn off the appliance or move the TV.
Double images or "ghost" images	<ul style="list-style-type: none"> • High-rise building or hills may be obstructing reception. Try using a highly directional antenna to improve the picture.
One white line across the screen	<ul style="list-style-type: none"> • Switch the TV off immediately and consult a qualified service person.
NICAM sound distortion (crackling noise)	<ul style="list-style-type: none"> • This could be due to antenna siting or reflected signal. • Switch over to "MONO" by pressing the I-II key on the remote control.

If your problem is not solved, switch the TV off and then back on again once. Never attempt to repair a defective TV yourself. Check with your dealer or call a TV technician.

Specifications

Picture/Display

- Aspect Ratio: 4:3
- Display Technology: Projection TV, CRT, 7" liquid cooled
- Picture Enhancement: Acclearium Digital Optics, Active Control, APAC, Auto Intellisense, Black Stretch, Blue Stretch, Digital Comb Filter, Color Temperature, Digital Crystal Clear, Digital Noise Reduction, Dynamic Contrast, Progressive Scan, 100Hz Digital Scan
- Screen Enhancements: Saphlon Screen, Anti- Aging Circuit, Anti-Reflection, High Brightness, High Contrast
- Size: 43PP8545, 43": 50PP8545, 50"

Supported Display Resolution

- Computer Formats: 640 x 480, 60Hz
- Video Formats: 480i 60Hz, 480p 60Hz, 576i 50Hz, 576p 50Hz, 1080i 60Hz

Sound

- Bass Enhancement: Bass Boost
- Output Power (RMS): 30 watt RMS (50Hz-10kHz at 5% THD)
- Sound Enhancement: Automatic Volume Leveler
- Speaker Size: 4"x6"
- Speaker Number: 2
- Speaker Type: full range oval

Tuner/Reception

- Aerial Input: 75 Ohm IEC-Type
- Auto Store: Yes
- Standards: NTSC M (3.58-4.5), NTSC (4.43-5.5), PAL B/G, PAL D/K, PAL I, SECAM B/G, SECAM D/K, SECAM K1

Connectivity

- AV1: 480i 60Hz, 576i 50Hz, CVBS in, YPbPr, Audio L/R in
- AV2: 480i 60Hz, 576i 50Hz, CVBS in, S-Video Y/C, Audio L/R in
- AV3: Side, 480i 60Hz, 576i 50Hz, CVBS in, S-Video Y/C, Audio L/R in, Headphone out
- AV4: 1080i 60Hz, 480p 60Hz, 576p 50Hz, YPbPr, RGB+H/V
- AV5: 1080i 60Hz, 480p 60Hz, 576p 50Hz, DB15, RGB+H/V
- Output Rear: Subwoofer out, CVBS out, Audio L/R out

Convenience

- Child Protection: Child Lock, Parental Control
- Clock Functions: Clock, Sleep Timer
- Convenience Enhancements: Auto Program, Auto Picture Modes, Auto Sound Modes
- Menu Languages: /93 Chinese-Simplified, English /69 and /79: Chinese-Simplified, English, Malay
- Picture Functions: Freeze
- Teletext: 100 page Easytext (Not available on /93.)
- Remote Control: RCS82D, Batteries

Dimensions

43PP8545

- Product Dimensions (WxHxD): 96 cm x 115 cm x 53 cm
- Product Weight: 57 kg
- Carton Dimensions: 106 cm x 125 cm x 62 cm
- Weight incl. Packaging: 65 kg

50PP8545

- Product Dimensions (WxHxD): 113 cm x 148 cm x 62 cm
- Product Weight: 82 kg
- Carton Dimensions: 125 cm x 154 cm x 71 cm
- Weight incl. Packaging: 94 kg

Power

- Complies with Energy Star, less than 1 watt standby
- Mains Power: /69, 79: 90-276V, 50/60Hz /93: 160-276V, 50/60 Hz.
- Power Consumption: 180 watts average

These technical specifications are subject to change without notice.

