

User Manual



27PT5441/37

32PT5441/37

27PT6441/37

27PT6442/37



Thank you for choosing Philips.

Need help fast?

***Read your User Manual first for quick tips that
your using your Philips product more enjoyable. If
you have read your instructions and still need
assistance you may access our online help at
www.p4c.philips.com
or
call 1-888-PHILIPS (1-888-744-5477)
while with your product.***

Model No.: _____
Serial No.: _____

PHILIPS

3121 235 21512

Return your Product Registration Card today to get the very most from your purchase.

Congratulations on your purchase, and welcome to the "family!"

Dear PHILIPS product owner:

Thank you for your confidence in PHILIPS. You've selected one of the best-built, best-backed products available today. We'll do everything in our power to keep you happy with your purchase for many years to come.

As a member of the PHILIPS "family," you're entitled to protection by one of the most comprehensive warranties and outstanding service networks in the industry. What's more, your purchase guarantees you'll receive all the information and special offers for which you qualify, plus easy access to accessories from our convenient home shopping network.

Most importantly, you can count on our uncompromising commitment to your total satisfaction.

All of this is our way of saying welcome - and thanks for investing in a PHILIPS product.

P.S. To get the most from your PHILIPS purchase, be sure to complete and return your Product Registration Card at once.

Registering your model with PHILIPS makes you eligible for all of the valuable benefits listed below, so don't miss out. Complete and return your Product Registration Card at once to ensure:

*Proof of Purchase

Returning the enclosed card guarantees that your date of purchase will be on file, so no additional paperwork will be required from you to obtain warranty service.

*Product Safety Notification

By registering your product, you'll receive notification - directly from the manufacturer - in the rare case of a product recall or safety defect.

*Additional Benefits of Product Ownership

Registering your product guarantees that you'll receive all of the privileges to which you're entitled, including special money-saving offers.

Know these safety symbols



 This "bolt of lightning" indicates uninsulated material within your unit may cause an electrical shock. For the safety of everyone in your household, please do not remove product covering.

 The "exclamation point" calls attention to features for which you should read the enclosed literature closely to prevent operating and maintenance problems.

WARNING: To reduce the risk of fire or electric shock, this apparatus should not be exposed to rain or moisture and objects filled with liquids, such as vases, should not be placed on this apparatus.

CAUTION: To prevent electric shock, match wide blade of plug to wide slot, fully insert.

ATTENTION: Pour éviter les choc électriques, introduire la lame la plus large de la fiche dans la borne correspondante de la prise et pousser jusqu'au fond.

PHILIPS Visit our World Wide Web Site at <http://www.philips.com>

IMPORTANT SAFETY INSTRUCTIONS

Read before operating equipment

1. Read these instructions.
2. Keep these instructions.
3. Heed all warnings.
4. Follow all instructions.
5. Do not use this apparatus near water.
6. Clean only with a dry cloth.
7. Do not block any of the ventilation openings. Install in accordance with the manufacturers instructions.
8. Do not install near any heat sources such as radiators, heat registers, stoves, or other apparatus (including amplifiers) that produce heat.
9. Do not defeat the safety purpose of the polarized or grounding-type plug. A polarized plug has two blades with one wider than the other. A grounding type plug has two blades and third grounding prong. The wide blade or third prong are provided for your safety. If the provided plug does not fit into your outlet, consult an electrician for replacement of the obsolete outlet.
10. Protect the power cord from being walked on or pinched particularly at plugs, convenience receptacles, and the point where they exit from the apparatus.
11. Only use attachments/accessories specified by the manufacturer.
12.  Use only with a cart, stand, tripod, bracket, or table specified by the manufacturer, or sold with the apparatus. When a cart is used, use caution when moving the cart/apparatus combination to avoid injury from tip-over.
13. Unplug this apparatus during lightning storms or when unused for long periods of time.
14. Refer all servicing to qualified service personnel. Servicing is required when the apparatus has been damaged in any way, such as power-supply cord or plug is damaged, liquid has been spilled or objects have fallen into apparatus, the apparatus has been exposed to rain or moisture, does not operate normally, or has been dropped.
15. This product may contain lead and mercury. Disposal of these materials may be regulated due to environmental considerations. For disposal or recycling information, please contact your local authorities or the Electronic Industries Alliance: www.eiae.org
16. **Damage Requiring Service** - The appliance should be serviced by qualified service personnel when:
 - A. The power supply cord or the plug has been damaged; or
 - B. Objects have fallen, or liquid has been spilled into the appliance; or
 - C. The appliance has been exposed to rain; or
 - D. The appliance does not appear to operate normally or exhibits a marked change in performance; or
 - E. The appliance has been dropped, or the enclosure damaged.
17. **Tilt/Stability** - All televisions must comply with recommended international global safety standards for tilt and stability properties of its cabinet design.
 - Do not compromise these design standards by applying excessive pull force to the front, or top, of the cabinet which could ultimately overturn the product.
 - Also, do not endanger yourself, or children, by placing electronic equipment/toys on the top of the cabinet. Such items could unsuspectingly fall from the top of the set and cause product damage and/or personal injury.
18. **Wall or Ceiling Mounting** - The appliance should be mounted to a wall or ceiling only as recommended by the manufacturer.
19. **Power Lines** - An outdoor antenna should be located away from power lines.
20. **Outdoor Antenna Grounding** - If an outside antenna is connected to the receiver, be sure the antenna system is grounded so as to provide some protection against voltage surges and built up static charges. Section 810 of the National Electric Code, ANSI/NFPA No. 70-1984, provides information with respect to proper grounding of the mast and supporting structure, grounding of the lead-in wire to an antenna discharge unit, size of grounding connectors, location of antenna-discharge unit, connection to grounding electrodes, and requirements for the grounding electrode. See Figure below.
21. **Object and Liquid Entry** - Care should be taken so that objects do not fall and liquids are not spilled into the enclosure through openings.
 - a) Warning: To reduce the risk of fire or electric shock, this apparatus should not be exposed to rain or moisture and objects filled with liquids, such as vases, should not be placed on this apparatus.
22. **Battery Usage CAUTION** - To prevent battery leakage that may result in bodily injury, property damage, or damage to the unit:
 - Install all batteries correctly, with + and - aligned as marked on the unit.
 - Do not mix batteries (old and new or carbon and alkaline, etc.).
 - Remove batteries when the unit is not used for a long time.

Note to the CATV system installer: This reminder is provided to call the CATV system installer's attention to Article 820-40 of the NEC that provides guidelines for proper grounding and, in particular, specifies that the cable ground shall be connected to the grounding system of the building, as close to the point of cable entry as practical.

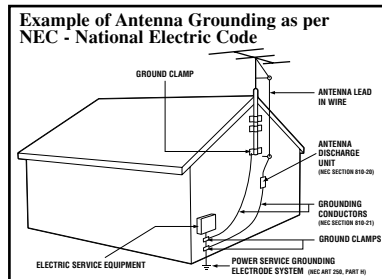

PANEL LAYOUT

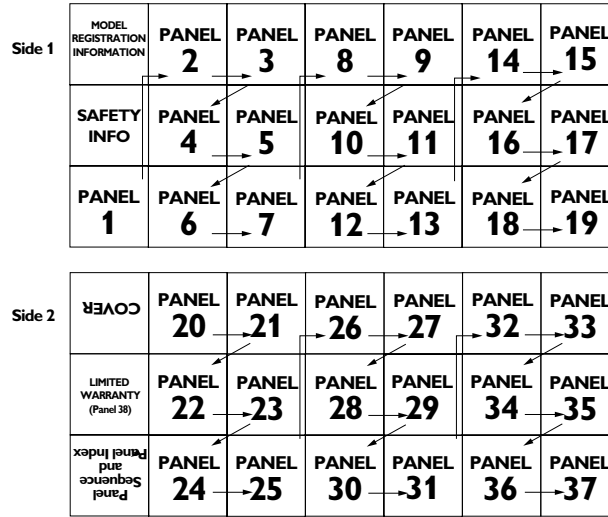

PANEL INDEX

Subject	Panel No.	Subject	Panel No.
Active Control	.23	Cable Box Connection	.2
Antenna/Cable Basic Connection	.1	Care and Cleaning	.36
Audio/Video Connections		Channel Edit	.14
AVI Input Jacks	.4	Clock Controls	
Component Video Input Jacks	.7	Activate Control	.21
Headphone Jack	.5	Clock	.18
Monitor Output Jacks	.8	Display Control	.22
S-Video Input Jacks	.6	Specific Channel	.20
Side AV Input Jacks	.5	Start or Stop Time	.19
AutoLock™ Controls		Closed Caption Control	.31
Access Code	.25	Demo Mode	.30
Block All Channels	.27	Format Control	.17
Block Channels	.26	Language Controls	.11
Clear All Blocked Channels	.27	Limited Warranty	.37
Movie Ratings	.28	Picture Menu Controls	.15
Other Blocking Options	.30	QuadraSurf™	.33-34
TV Ratings	.29	Remote Batteries	.3
Understanding AutoLock™	.24	Remote Button Descriptions	.9-10
Automatically Programming TV	.13	Sleeptimer	.31
AutoPicture™ Control	.32	Sound Menu Controls	.16
AutoSound™ Control	.32	Troubleshooting	.35
Basic Remote Operation	.3	Tuner Mode	.12
Basic Television Operation	.3		

Active Control, AutoPicture, AutoSound, and Incredible Surround are trademarks of Philips Consumer Electronics Company. Copyright 2001 Philips Consumer Electronics.*Manufactured under license from Dolby Laboratories. "Dolby" and the double-D symbol are trademarks of Dolby Laboratories.

I BASIC ANTENNA AND CABLE CONNECTIONS

Your home's signal input might come from a single (75 ohm) round cable, a Converter Box, or from an antenna. In either case the connection to the TV is very easy.

- 1 If your Cable TV signal or Antenna signal is a round cable (75 ohm)** then you're ready to connect to the TV.

If your antenna has flat twin-lead wire (300 ohm), you first need to attach the antenna wires to the screws on a 300 to 75 ohm adapter.

If you have a Cable Converter Box: Connect the Cable TV signal to the Cable Signal IN(put) plug on the Converter.

Antenna Connection

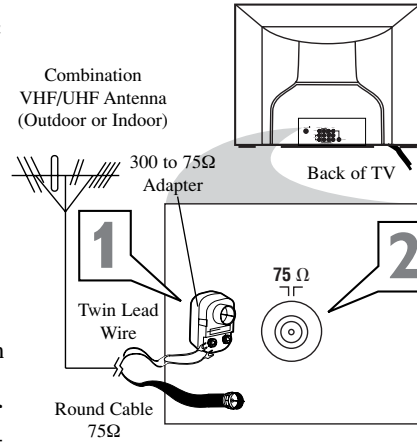

- 2 Connect the Cable TV cable or Antenna cable (or 300 to 75 ohm adapter) to the 75Ω plug on the TV.**

If you have a Cable Converter Box: Connect the OUT(put) plug from the Converter to the 75Ω plug on the TV.

Direct Cable Connection

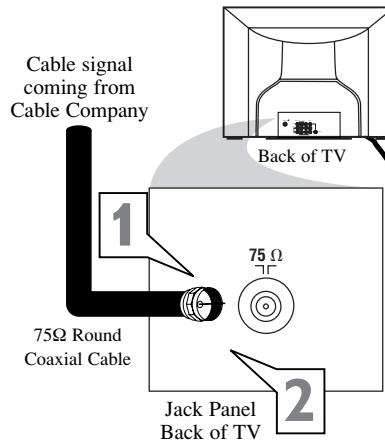

HELPFUL HINT

After using the AutoProgram Control, press the CH + and – buttons to scroll through all the channels stored in the television's memory.

2

CABLE BOX CONNECTIONS

If your cable signal uses a cable box or decoder, follow the easy steps below to complete the connection.

Cable Box (w/RF In/Outputs):

This connection will be mono.

- 1** Connect the Cable Company supplied cable to the signal IN(put) plug on the back of the Cable Box.
- 2** Using a separate round coaxial cable, connect one end to the OUT(put) (TO TV) plug on the back of the Cable Box.
- 3** Connect the other end of the round coaxial cable to the 75Ω input on the back of the television. Screw it down finger tight.

NOTE: If applicable, set the OUTPUT CHANNEL SWITCH on the back of the cable box to CH 3 or 4. Tune the TV to the same channel and change channels at the cable box. In some cases, the cable box will automatically tune to either channel 3 or 4, change channels until the picture appears.

Cable Box (w/Audio/Video Outputs):

This connection will supply Stereo sound.

- 4** Connect the Cable Company supplied cable to the cable signal IN(put) plug on the back of the Cable Box.
- 5** Using a RCA type Video Cable, connect one end of the cable to the Video (or ANT, your cable box may be labeled differently) Out jack on the cable box and the other end to the AV1 Video Input on the TV.
- 6** Connect one end of the Audio Left and Right Cable to the left and right Audio Out L & R jacks on the cable box. Connect the other end to the AV1 Audio L & R Input jacks on the TV.

NOTE: Use the AV button on the TV remote control to tune to the AV1 channel for the cable box signal. Once tuned, change channels at the cable box, not the television.

Cable Box (w/RF In/Outputs):

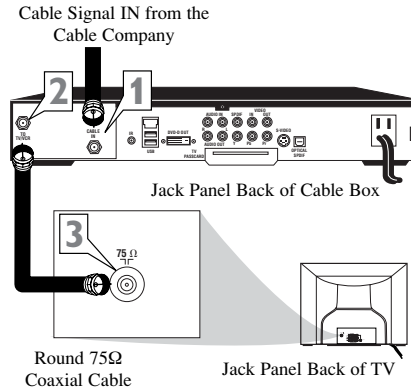

Cable Box (w/Audio/Video Outputs):

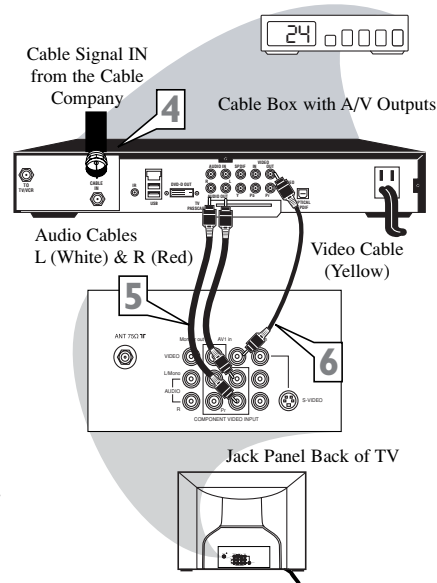

3 BASIC TV AND REMOTE CONTROL OPERATION

- 1 Press the **POWER** button to turn the TV ON.

Note: You can also press any button on the front of the TV to turn the TV ON.

- 2 Press the **VOLUME +** button to increase the sound level, or the **VOLUME -** button to lower the sound level.

Pressing both buttons at the same time will display the on-screen menu. Once in the menu, use these buttons to make adjustments or selections.

- 3 Press the **CHANNEL UP +** or **CHANNEL DOWN -** button to select TV channels.

- 4 Point the remote control toward the remote sensor window on the TV when operating the TV with the remote.

Example of Models 27PT6441/37 and 27PT6442/37

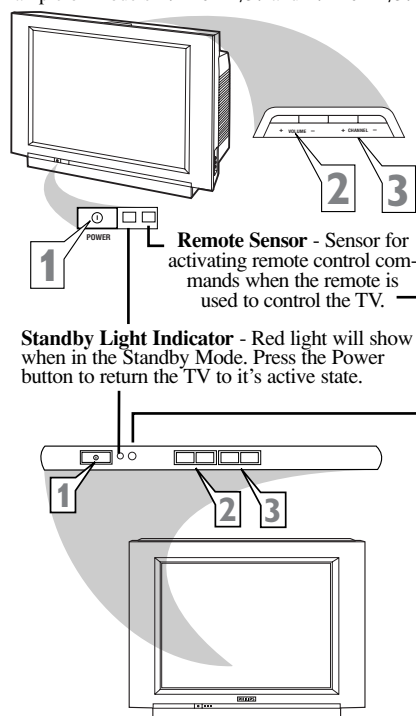

Remote Sensor - Sensor for activating remote control commands when the remote is used to control the TV.

Standby Light Indicator - Red light will show when in the Standby Mode. Press the Power button to return the TV to its active state.

Example of Models 27PT5441/37 and 32PT5441/37

REMOTE CONTROL

To load the supplied batteries into the remote:

1. Remove the **battery compartment lid** on the back of the remote.
2. Place the **batteries (2-AA)** in the remote. Be sure the (+) and (-) ends of the batteries line up correctly (inside of case is marked.)
3. Reattach the **battery lid**.

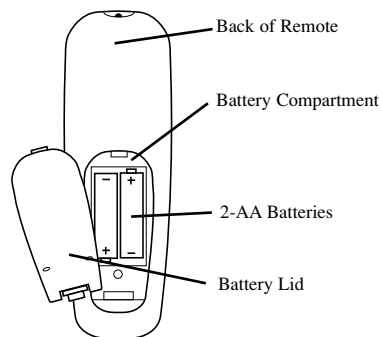

4 AV (AUDIO/VIDEO) INPUT CONNECTION

The TV's audio/video input jacks are for direct picture and sound connections between the TV and a VCR (or similar device) that has audio/video output jacks. Both the AV1 and AV2 Input Jack connections are shown on this page, but either one can be connected alone. Follow the easy steps below to connect your accessory device to the AV1 and AV2 IN Jacks located on the back of the TV.

- 1** Connect the VIDEO (yellow) cable to the VIDEO AV1 IN (or AV2 IN) jack on the back of the TV.
- 2** Connect the AUDIO (red and white) cables to the AUDIO (left and right) AV1 IN (or AV2 IN) jacks on the rear of the TV.
- 3** Connect the VIDEO (yellow) cable to the VIDEO OUT jack on the back of the VCR (either one or two) or accessory device being used.
- 4** Connect the AUDIO (red and white) cables to the AUDIO (left and right) OUT jacks on the rear of the VCR (either one or two) or accessory device being used.
- 5** Turn the VCR (either one or two) or accessory device and the TV ON.
- 6** Press the AV button to set the TV to its AV1 or AV2 channel.
- 7** With either of the VCRs (or accessory devices) ON and a pre-recorded tape (CD, DVD, etc.) inserted, press the PLAY button to view the tape on the television.

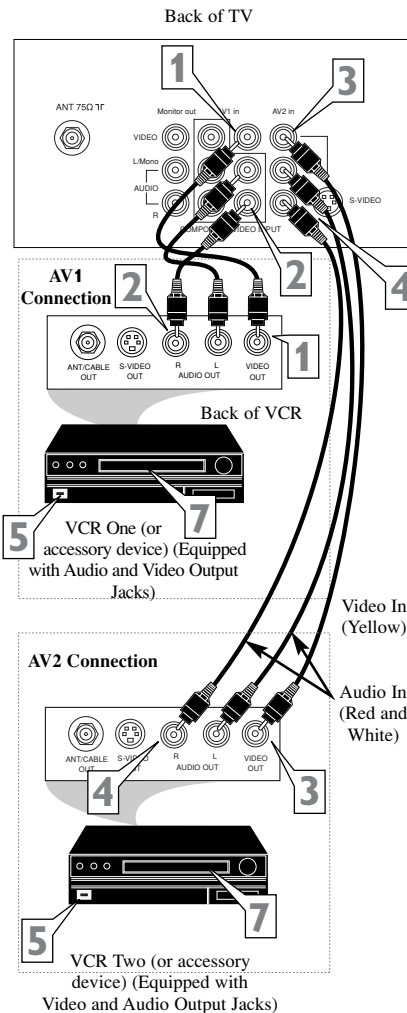

HELPFUL HINT

Audio and video cables are not supplied with the TV, but are available from Philips or electronics retailers.

5

SIDE AV CONNECTIONS

Audio and Video Side Inputs are available for a quick connection of a VCR, to playback video from a camera, or attach a gaming device. Use the AV button on the remote control to tune these inputs.

- 1** Connect the video (yellow) cable from the Video output on the Camera (or accessory device) to the Video (yellow) Input located on the SIDE of the TV.
- 2** For Stereo Devices: Connect the audio cable (red and white) from the Audio Left and Right Outputs on the Camera to the Audio In (white) jack on the SIDE of the television.
For Mono Devices: Connect one end of the audio cable from the Audio Out jack on the device to the Audio In (white) jack on the SIDE of the television.
- 3** Turn the TV and the accessory device ON.
- 4** Press the AV button on the remote control to tune the TV to the side input jacks. "Front" will appear on the TV screen.
- 5** Press the PLAY ► button on the accessory device to view playback, or to access the accessory device (camera, gaming unit, etc.).

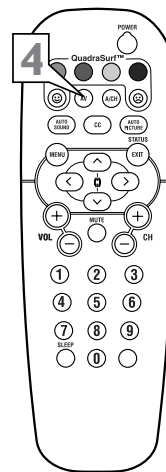
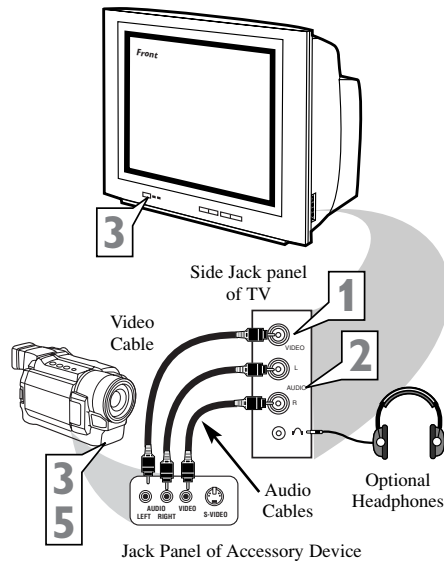

6

S-VIDEO (S-VHS) INPUT CONNECTIONS

The S(uper)-Video connection on the rear of the TV can provide you with better picture detail and clarity for the playback of accessory sources such as DBS (digital broadcast satellite), DVD (digital video discs), video games, and S-VHS VCR (video cassette recorder) tapes than the normal antenna picture connections.

NOTE: The accessory device must have an S-VIDEO OUT(put) jack in order for you to complete the connection on this page.

- 1** Connect one end of the S-VIDEO CABLE to the S-VIDEO jack on the back of the TV. Then connect one end the AUDIO (red and white) CABLES to the AV1 in AUDIO L and R (left and right) jacks on the rear of the TV.
- 2** Connect other end of the S-VIDEO CABLE to the S-VHS (S-Video) OUT jack on the back of the VCR. Then connect the other ends of the AUDIO (red and white) CABLES to the AUDIO (left and right) OUT jacks on the rear of the VCR.
- 3** Turn the VCR and the TV ON.
- 4** Press the AV button or the CH + or CH - buttons on the remote to scroll the channels until SVHS appears in the upper left corner of the TV screen.
- 5** Now your ready to place a pre-recorded video tape in the VCR and press the PLAY ► button.

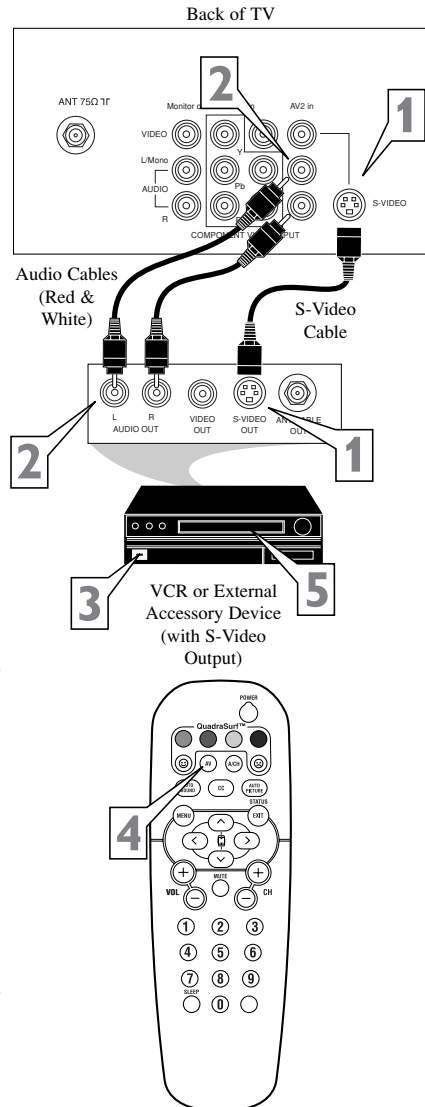

7 COMPONENT VIDEO (CVI) INPUT CONNECTIONS

Component Video inputs provide for the highest possible color and picture resolution in the playback of digital signal source material, such as with DVD players. The color difference signals (Pb, Pr) and the luminance (Y) signal are connected and received separately, which allows for improved color bandwidth information (not possible when using composite video or S-Video connections).

- 1** Connect the Component (Y, Pb, Pr) Video OUT jacks from the DVD player (or similar device) to the (Y, Pb, Pr) in(put) jack on the TV. When using the Component Video Inputs, it is best not to connect a signal to the AV in Video Jack.
- 2** Connect the red and white AUDIO CABLES to the Audio (left and right) output jacks on the rear of the accessory device to the Audio (L and R) AV1 in Input Jacks on the TV.
- 3** Turn the TV and the DVD (or digital accessory device) ON.
- 4** Press the AV button or the CH + or CH - buttons to scroll the available channels until CVI appears in the upper left corner of the TV screen.
- 5** Insert a DVD disc into the DVD player and press the PLAY button on the DVD Player.

The CVI connection will dominate over the AV1 in Video Input. When a Component Video Device is connected as described, it is best not to have a video signal connected to the AV1 in Video Input jack.

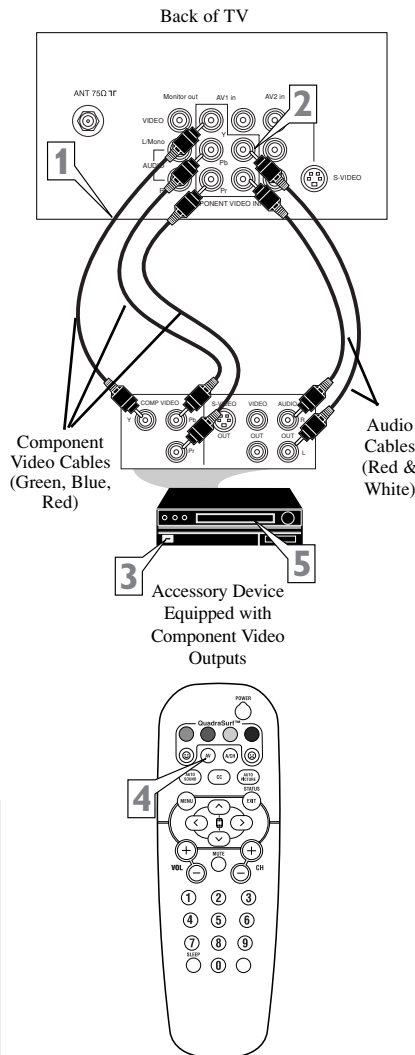

HELPFUL HINT

The description for the component video connectors may differ depending on the DVD player or accessory digital source equipment used (for example, Y, Pb, Pr; Y, B-Y, R-Y; Y, Cr, Cb). Although abbreviations and terms may vary, the letters *b* and *r* stand for the blue and red color component signal connectors, and *Y* indicates the luminance signal. Refer to your DVD or digital accessory owner's manual for definitions and connection details.

8

MONITOR OUT(PUT) CONNECTIONS

The Audio/Video (Monitor) Output jacks are great for recording with a VCR or used to connect an external audio system for better sound reproduction.

AUDIO SYSTEM CONNECTION:

1 Connect one end of the **R(ight) and L(ef) AUDIO (Monitor Out)** jacks on the TV to the R and L audio input jacks on your amplifier or sound system. Set the audio system's volume to a normal listening level.

2 Turn the TV and audio system ON. To adjust the volume on the audio system, you will need to change the volume at the external audio system, not the television.

SECOND VCR CONNECTION:

NOTE: Refer to panel number 4 for the proper hookup of the first VCR. Follow the instructions on how to tune to the AV1 channel to view a pre-recorded tape.

The following steps allow you to connect a second VCR to record the program while you watching it.

3 Connect one end of the **yellow Video Cable** to the Monitor Out VIDEO plug. Connect the other end to the VIDEO IN plug on the second VCR.

4 Connect one end of the **red and white Audio cable** from the Monitor Out AUDIO L and R plugs on the TV to the AUDIO IN plugs on the VCR.

5 Turn the **Second VCR ON**, insert a VHS tape and it's ready to record what's being viewed on the TV screen.

AUDIO SYSTEM CONNECTION:

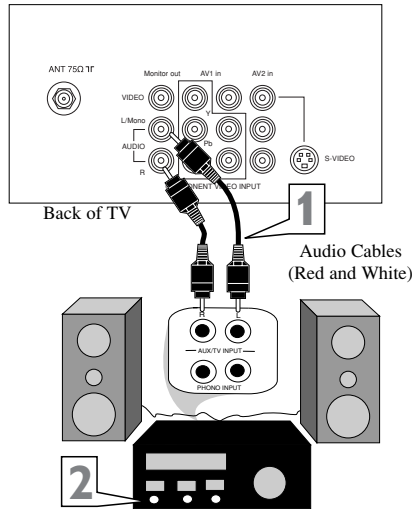

SECOND VCR CONNECTION:

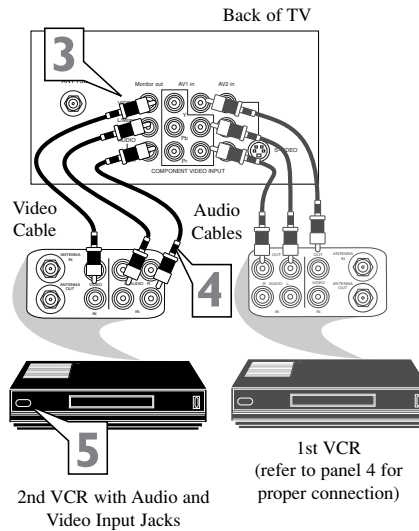

9 REMOTE CONTROL BUTTON DESCRIPTIONS

QUADRASURF Buttons

(Red, Green, Yellow, Blue) Allows you to store and surf up to 10 channels you choose for each colored button.

AV Button

Press to select an accessory signal input from the front AV Inputs.

SMILEY Button

Press to add channels to the "QuadraSurf" lists. Works with all colored buttons.

AUTO SOUND Button

Press repeatedly to choose from different factory pre-defined sound settings. Choose from Personal (how you set the Sound Menu options), Voice (for programming with speaking only), Music (for musical type programs such as concerts), or Theatre (used when watching movies).

MENU Button

Press to display the on-screen menu. Also can be used to back out of the on-screen menu until it disappears from the TV's screen.

CC Button

Press to activate the Closed Captioning options. Repeatedly pressing the CC button will scroll the available options on the TV screen.

VOL(ume) + or - Buttons

Press the VOL + button to increase the TV's sound level. Press the VOL - button to decrease the TV's sound level.

MUTE Button

Press the mute button to eliminate the sound being heard from the TV. "MUTE" will be displayed on the TV's screen. Press again to restore the TV's volume to it's previous level. pressing this button for 5 seconds will activate the Demo Mode. (See panel 30 for more details.)

SLEEP Button

Press the Sleep button to set the TV to automatically turn itself off after a set period of time. Press repeatedly to select 15, 30, 45, 60, 90, 120, 180, or 240 minutes.

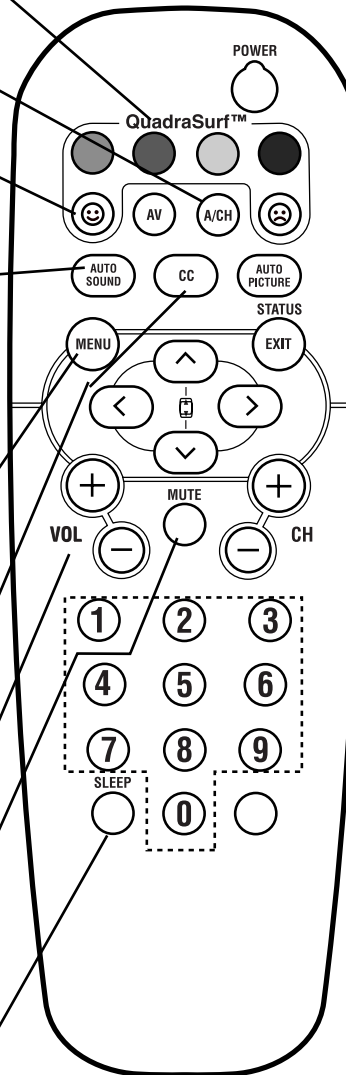

10 REMOTE CONTROL BUTTON DESCRIPTIONS

POWER Button
Press to turn the TV on or off.

A/CH Button (Alternate Channel)
Press to toggle between the last viewed channel and the channel presently being viewed.

FROWNIE Button
Allows you to delete channels from the “Quadra Surf” lists for the colored buttons. Works with all colored buttons.

AUTO PICTURE Button
Press repeatedly to choose from 5 different factory predefined picture settings. Choose from Personal (how you set the Picture Menu Adjustment controls), Movies (for movies), Sports (for any sporting event), Weak Signal (used when the signal being received is not great), or Multimedia (for video games).

STATUS/EXIT Button
Press to display the current channel number. If the on-screen menu is displayed, press the Status/Exit button of remove it from the TV’s screen.

▲, ▼, ◀, and ▶ Buttons
Press to navigate, select, and adjust controls within the on-screen menu. Also use the CURSOR ▲ or CURSOR ▼ to activate or deactivate the EXPAND 4:3 screen formatting control.

CH(annel) + or CH(annel)- Buttons
Press to select channels in ascending or descending order.

NUMBERED (0-9) Buttons
Press the numbered buttons to select TV channels or to enter certain values within the on-screen menu. For single channel entries, press the numbered button for the channel you desire. The TV will pause for a second or two before changing to the chosen channel.

CLOCK:
Press to display the “Timer” menu. Within this menu, set the time, set the TV to tune to a certain channel at a certain time once or daily.

HOW TO USE THE LANGUAGE CONTROL

For French and Spanish speaking TV owners an onscreen Language option is present. With the Language control you can set the TV's on-screen menu to be shown in English, French, or Spanish.

- 1** Press the **MENU** button on the remote control to show the on-screen menu.
- 2** Press the **CURSOR UP** \wedge or **DOWN** \vee buttons to scroll through the on-screen menu until the word **Install** is highlighted.
- 3** Press the **CURSOR RIGHT** $\>$ button to display the **Install** menu features.
- 4** Press the **CURSOR UP** \wedge or **DOWN** \vee buttons to scroll through the Install features until the word **Language** is highlighted.
- 5** Press the **CURSOR RIGHT** $\>$ button repeatedly to select English, Francais (French), or Español (Spanish).
- 6** When finished, press the **STATUS/EXIT** button to remove the menu from the TV's screen.

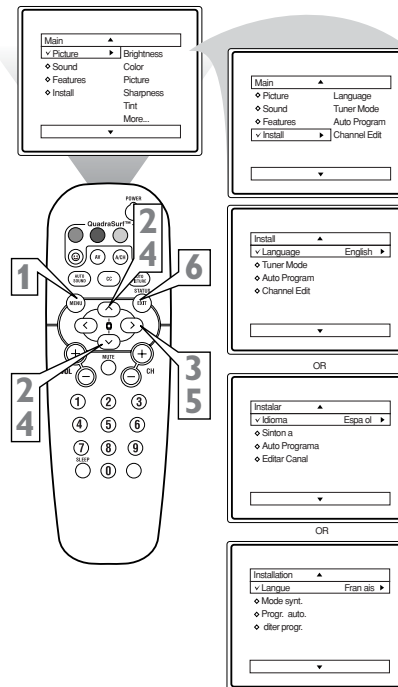

HELPFUL HINT

The Language control only makes the TV's on-screen Menu items appear in English, Spanish, or French text. It does not change the other on-screen text features such as Closed Caption (CC) TV shows.

12 HOW TO USE THE TUNER MODE CONTROL

The **TUNER MODE** control allows you to change the TV's input signal to either **ANTENNA**, **CABLE**, or **AUTO** mode. It's important for the TV to know what type of signal to look for (Cable TV or an Antenna). In the **AUTO** mode, when the **AUTO PROGRAM** feature is activated, the TV will automatically choose the correct mode.

- 1 Press the **MENU** button on the remote to show the on-screen menu.
- 2 Press the **CURSOR UP** \wedge or **DOWN** \vee buttons to scroll through the on-screen menu until the word **Install** is highlighted.
- 3 Press the **CURSOR RIGHT** $\>$ button to display the **Install** menu features.
- 4 Press **CURSOR UP** \wedge or **DOWN** \vee buttons to scroll the **Install** features until the words **Tuner Mode** is highlighted.
- 5 Press the **CURSOR RIGHT** $\>$ button to select either **Antenna**, **Cable**, or **Auto** mode.
- 6 When finished, press the **STATUS /EXIT** button to remove the on-screen menu from the TV's screen.

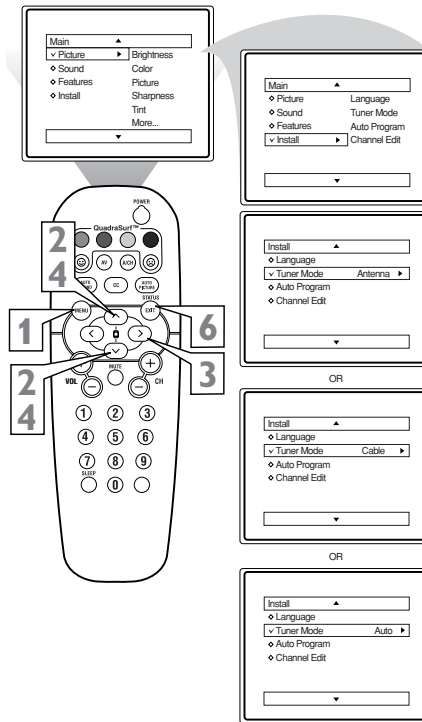

HELPFUL HINTS

When **CABLE** is selected, channels 1-125 are available.

When **ANTENNA** is selected, channels 2-69 are available.

When **AUTO** is selected, the TV will automatically set itself to the correct mode based on the type of signal it detects when the **AUTO PROGRAM** feature is activated.

13

AUTOMATICALLY PROGRAM

Your TV can automatically set itself for local area (or Cable TV) channels. This makes it easy for you to select only the TV stations in your area when the CHANNEL (+), (-) buttons are pressed.

Note: Make sure the antenna or cable signal connection has been completed before AUTO PROGRAM is activated.

- 1** Press the MENU button on the remote to show the on-screen menu.
- 2** Press the CURSOR UP ^ or DOWN v buttons to scroll through the on-screen menu until the word **Install** is highlighted.
- 3** Press the CURSOR RIGHT > button to display the **Install** menu features.
- 4** Press CURSOR UP ^ or DOWN v buttons to scroll the Install features until the words **Auto Program** are highlighted.
- 5** Press the CURSOR RIGHT > button to start the Auto Program scanning of channels. Auto Programming will store all available channels in the TV's memory then tune to the lowest available channel when done.
- 6** When finished, press the STATUS /EXIT button to remove the menu from the TV's screen.

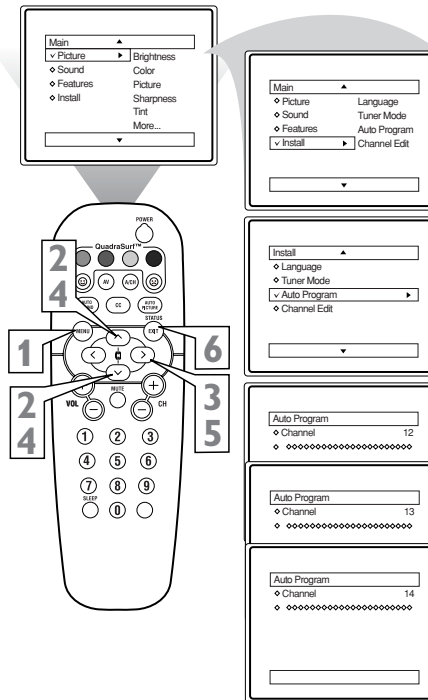

HELPFUL HINTS

When CABLE is selected, channels 1-125 are available.

When ANTENNA is selected, channels 2-69 are available.

When AUTO is selected, the TV will automatically set itself to the correct mode based on the type of signal it detects when the AUTO PROGRAM feature is activated.

14

CHANNEL EDIT

Channel Edit makes it easy for you to ADD or DELETE channels from the list of channels stored in the TV's memory.

- 1** Press the **MENU** button on the remote control to show the on-screen menu.
- 2** Press the **CURSOR UP** \wedge or **DOWN** \vee buttons to scroll through the on-screen menu until the word **Install** is highlighted.
- 3** Press the **CURSOR RIGHT** $\>$ button to display the **Install** menu features.
- 4** Press the **CURSOR UP** \wedge or **DOWN** \vee buttons to scroll through the Install features until the words **Channel Edit** are highlighted.
- 5** Press the **CURSOR RIGHT** $\>$ button to display the Channel Edit options.
- 6** With the **Channel Edit** options displayed, and **Channel** highlighted; you can use the cursor buttons to scroll through all available channels that you wish to add (skipped OFF) or delete (Skipped ON) from the TV's memory. You can also use the **NUMBERED** buttons to go directly to a specific numbered channel that you want to add or skip. Or, you can also use the **CH+** or **CH-** to quickly scan through the channels that have not been skipped.
- 7** Using the **CURSOR DOWN** \vee button, scroll the menu to highlight the word **SKIPPED**.
- 8** Now use the **CURSOR RIGHT** $\>$ to toggle between **On** or **Off**. If **ON** is selected the channels is skipped when scrolling channels with the **CH+** or **CH-** buttons. If **OFF** is selected the channels is not skipped when scrolling channels with the **CH+** or **CH-** buttons.
- 9** When finished, press the **STATUS/EXIT** button to remove the menu from the screen.

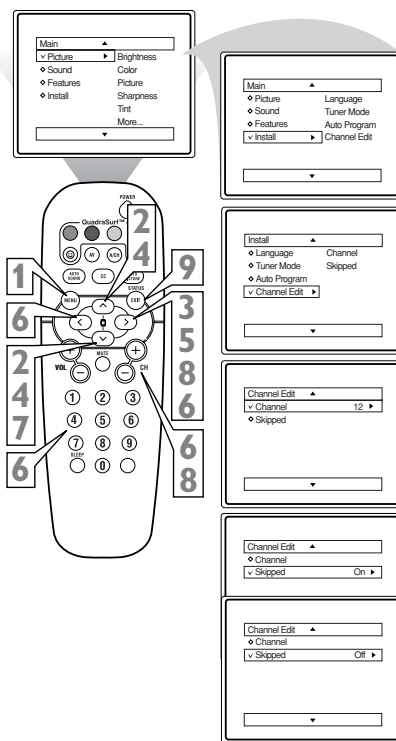

HELPFUL HINTS

An "X" appearing in front of any channel will indicate that channel has skip on. When the CH + or CH - buttons are used, those channels will be skipped.

15

PICTURE MENU CONTROLS

To adjust your TV picture controls, select a channel and use the Picture Menu Controls listed below:

- 1 Brightness Control** - Press the **CURSOR RIGHT >** or **LEFT <** buttons until the darkest parts of the picture are as bright as you prefer.
- 2 Color Control** - Press the **CURSOR RIGHT >** or **LEFT <** buttons to add or eliminate color.
- 3 Picture Control** - Press the **CURSOR RIGHT >** or **LEFT <** buttons until lightest parts of the picture show good detail.
- 4 Sharpness Control** - **CURSOR RIGHT >** or **LEFT <** buttons to improve detail in the picture.
- 5 Tint Control** - Press the **CURSOR RIGHT >** or **LEFT <** buttons to obtain natural skin tones.
- 6 Color Temp Control** - Press the **CURSOR RIGHT >** or **LEFT <** buttons to select Normal, Cool, or Warm picture preferences. (Normal will keep the whites, white; Cool will make the whites, bluish; and Warm will make the whites, red-dish.)
- 7 DNR Control** - Press the **CURSOR RIGHT >** or **LEFT <** buttons to turn DNR On or Off. Dynamic Noise Reduction helps to eliminate "noise" from the picture.
- 8 Contrast + Control** - Press the **CURSOR RIGHT >** or **LEFT <** buttons to toggle the control On or OFF. The Contrast + control helps to "sharpen" the picture quality. The black portions of the picture become richer in darkness and the whites become brighter.

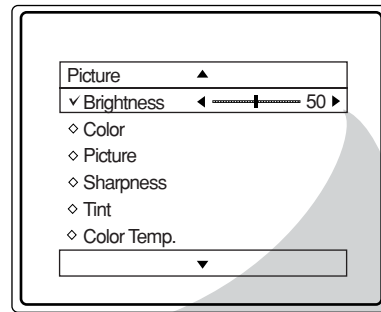

✓ Brightness ←—————|————→ 65

✓ Color ←—————|————→ 50

✓ Picture ←—————|————→ 50

✓ Sharpness ←—————|————→ 50

✓ Tint ←—————|————→ 0

✓ Color Temp. Normal
Warm
or
Cool

✓ DNR On
Off

✓ Contrast + On
Off

16

SOUND MENU CONTROLS

To adjust your TV sound, select and use the Sound Menu Controls listed below:

- 1 Treble:** Press the **CURSOR RIGHT** > or **LEFT** < buttons to adjust the control. The control will enhance the high frequency sounds.
- 2 Bass:** Press the **CURSOR RIGHT** > or **LEFT** < buttons to adjust the control. The control will enhance the low frequency sounds.
- 3 Balance:** Press the **CURSOR RIGHT** > or **LEFT** < buttons to adjust the level of sound coming from the left and right speakers.
- 4 AVL:** (Auto Volume Leveler) Press the **CURSOR RIGHT** > or **LEFT** < buttons to turn the control On or Off. When On, AVL will level out the sound being heard when sudden changes in volume occur during commercial breaks or channel changes.
- 5 Incr. Surround:** Press the **CURSOR RIGHT** > or **LEFT** < buttons to select between Dolby Virtual or Stereo settings (If Stereo), or select Spatial or Mono (If Mono).
- 6 SAP:** Press the **CURSOR RIGHT** > or **LEFT** < buttons to toggle this control to On or Off. SAP is short for Secondary Audio Programming and is sent as a third audio channel, a SAP signal can be heard apart from the current TV program sound. Note: If SAP is not present on a selected show No SAP will appear on the screen.
- 7 Sound:** Press the **CURSOR RIGHT** > or **LEFT** < buttons to select between Stereo or Mono settings. Note: If Stereo is not present on a selected show and the TV is placed in the Stereo mode, the sound coming from the TV will remain in the Mono mode.

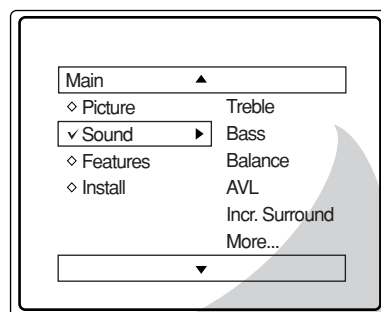

✓ Treble ◀ ———▶ 50 ▶

✓ Bass ◀ ———▶ 50 ▶

✓ Balance ◀ L ———▶ R ▶

✓ AVL On
or Off

✓ Incr. Surround Spatial
or Mono

✓ Incr. Surround Dolby Virtual
or Stereo

✓ SAP On
or Off

✓ Sound Mono
or Stereo

17 HOW TO USE THE 4:3 EXPAND FORMAT CONTROL

Many times while watching movies from a DVD player the image is shown in "letter box" format. This is the format that is shown in movie theaters, when shown on a TV screen, the image will have areas of black on top and bottom of the screen.

- 1 Press the CURSOR UP \wedge or DOWN \vee buttons** to select one of the two options 4:3 or Expand 4:3.
4:3 - Standard format for the TV.
Expand 4:3 - Enlarges the picture to fill out the entire screen area, eliminating the "letter box" effect.



4:3



Expand 4:3

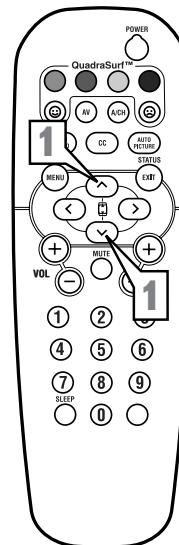

18 SETTING THE TV CLOCK USING THE TIMER CONTROL

Your television comes with an on-screen clock. During normal operation, the clock appears on the screen when the STATUS/EXIT button is pressed or if the Timer Display control is turned On.

- 1 Press the **MENU** button on the remote to show the on-screen menu.
- 2 Press the **CURSOR UP** \wedge or **DOWN** \vee buttons to scroll through the on-screen menu until the word **Features** is highlighted.
- 3 Press the **CURSOR RIGHT** $\>$ button to display the **Features** menu.
- 4 Press the **CURSOR RIGHT** $\>$ button to display the **Timer** menu.
- 5 Enter the correct time by using the **Numbered** buttons.
- 6 Press the **CURSOR RIGHT** $\>$ or **CURSOR LEFT** \leftarrow buttons to change the AM or PM setting.
- 7 When finished, press the **STATUS /EXIT** button to remove the on-screen menu from the TV's screen.

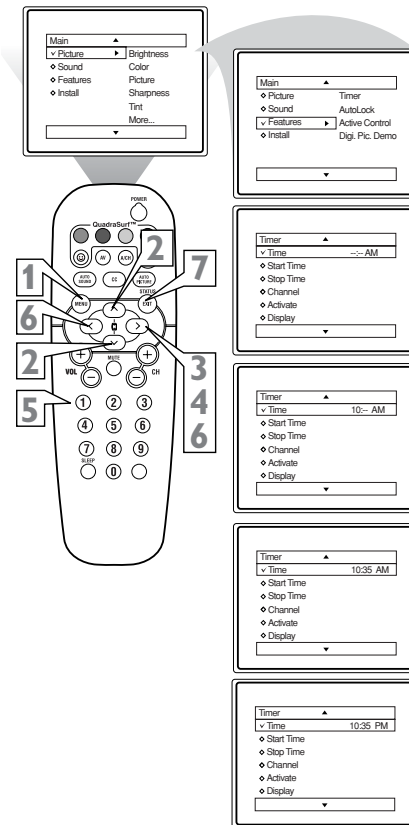

NOTE: Active Control will only appear in the menu of models 27PT6441/37 and 27PT6442/37.

HELPFUL HINTS

Remember, be sure to press "0" and then the hour number for single digit entries.

You can get to the Clock setting by pressing the Clock button on the remote control.

The TV's clock settings may be lost when the TV is unplugged or when AC power to the set is interrupted.

19 SETTING TV TO TURN ON OR OFF USING START OR STOP CONTROLS

You can set your TV to turn itself on or off. You can set the TV to turn itself On or Off once or at the same time everyday. Follow the steps below to set the Start and Stop Time.

- 1** Press the MENU button on the remote to show the on-screen menu.
- 2** Press the CURSOR UP ^ or DOWN v buttons to scroll through the on-screen menu until the word Features is highlighted.
- 3** Press the CURSOR RIGHT > button to display the Features menu.
- 4** Press the CURSOR RIGHT > button to display the Timer menu.
- 5** Press the CURSOR UP ^ or DOWN v buttons to scroll through the Timer menu until Start Time or Stop Time is highlighted.
- 6** Enter the correct time by using the Numbered buttons.
- 7** Press the CURSOR RIGHT > or CURSOR LEFT < buttons to change the AM or PM setting.
- 8** When finished, press the STATUS /EXIT button to remove the on-screen menu from the TV's screen.

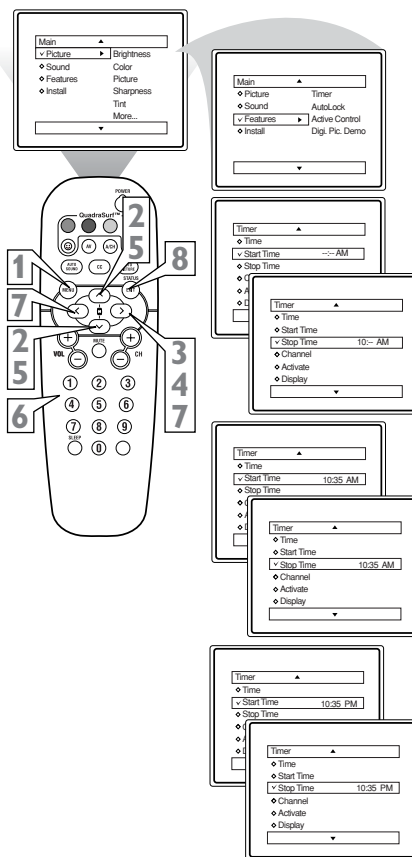

NOTE: The Activate Control must be set to Once or Daily for the television to turn On or Off at the specified time. See panel 21 for more details.

NOTE: Active Control will only appear in the menu of models 27PT6441/37 and 27PT6442/37.

HELPFUL HINTS

Remember, be sure to press "0" and then the hour number for single digit entries.

You can get to the Clock setting by pressing the Clock button on the remote control.

The TV's clock settings may be lost when the TV is unplugged or when AC power to the set is interrupted.

20 SETTING TV TO STARTUP ON A SPECIFIC CHANNEL

You can select a specific channel that the television will tune to when the timer turns the set On. Follow these steps to select the channel.

- 1** Press the **MENU** button on the remote to show the on-screen menu.
- 2** Press the **CURSOR UP** \wedge or **DOWN** \vee buttons to scroll through the on-screen menu until the word **Features** is highlighted.
- 3** Press the **CURSOR RIGHT** $\>$ button to display the **Features** menu.
- 4** With **Timer** selected, press the **CURSOR RIGHT** $\>$ button to display the **Timer** menu.
- 5** Press the **CURSOR UP** \wedge or **DOWN** \vee buttons to scroll through the **Timer** menu until **Channel** is highlighted.
- 6** Press the **Numbered** buttons to enter the desired start-up channel. Or, press the **CURSOR RIGHT** $\>$ or **CURSOR LEFT** \leftarrow or the **CH+** or **CH-** buttons repeatedly to enter the start-up channel you want.

NOTE: The **Activate Control** must be set to **Once** or **Daily** for this **Channel** control to take effect.

- 7** When finished, press the **STATUS /EXIT** button to remove the on-screen menu from the TV's screen.

NOTE: **Active Control** will only appear in the menu of models 27PT6441/37 and 27PT6442/37.

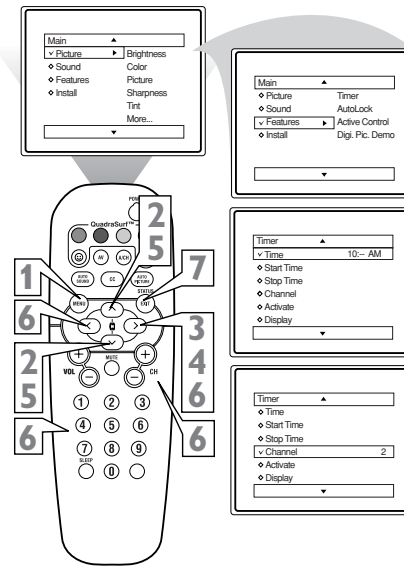

HELPFUL HINTS

Remember, be sure to press "0" and then the hour number for single digit entries.

You can get to the Clock setting by pressing the Clock button on the remote control.

The TV's clock settings may be lost when the TV is unplugged or when AC power to the set is interrupted.

21

ACTIVATE CONTROL

After you have set the Time, Start Time, Stop Time, and Start Channel, the timer must be set to come on Once or Daily, or turned Off through the Activate control.

- 1 Press the **MENU** button on the remote to show the on-screen menu.
- 2 Press the **CURSOR UP** \wedge or **DOWN** \vee buttons to scroll through the on-screen menu until the word **Features** is highlighted.
- 3 Press the **CURSOR RIGHT** $\>$ button to display the **Features** menu.
- 4 Press the **CURSOR UP** \wedge or **DOWN** \vee buttons to scroll through the on-screen menu until the word **Timer** is highlighted.
- 5 Press the **CURSOR RIGHT** $\>$ button to display the **Timer** menu.
- 6 Press the **CURSOR UP** \wedge or **CURSOR DOWN** \vee buttons to highlight the **Activate Control**.
- 7 Press the **CURSOR RIGHT** $\>$ or **CURSOR LEFT** $\<$ buttons repeatedly to select **Once**, **Daily**, or **Off**.
- 8 When finished, press the **STATUS/EXIT** button to remove the on-screen menu from the TV's screen.

NOTE: Active Control will only appear in the menu of models 27PT6441/37 and 27PT6442/37.

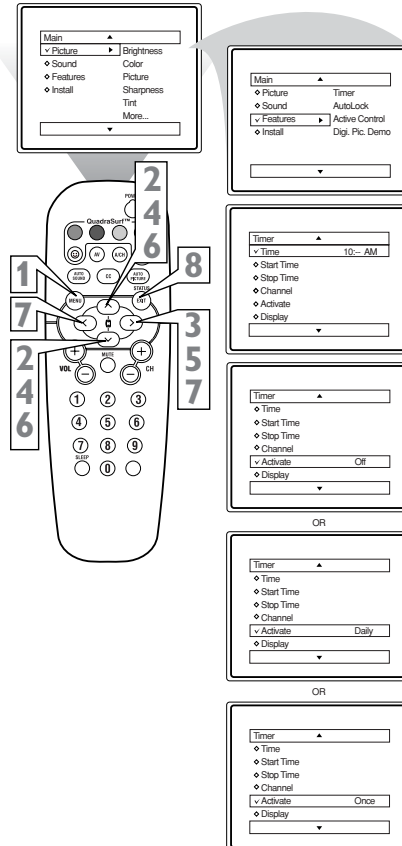

HELPFUL HINTS

Remember, before setting the Timer controls, the TV's clock must be set to the correct time, see panel 18 for details.

The TV's clock settings may be lost when the TV is unplugged or when AC power to the set is interrupted.

You can get to the Clock setting by pressing the Clock button on the remote control.

22 HOW TO VIEW TIME USING THE DISPLAY CONTROL

After the TV's clock has been set, you can use your TV as a clock. The Display control allows you to permanently display the time in the upper right corner of the screen.

- 1 Press the **MENU** button on the remote to show the on-screen menu.
- 2 Press the **CURSOR UP** \wedge or **CURSOR DOWN** \vee buttons to scroll through the on-screen menu until the word **Features** is highlighted.
- 3 Press the **CURSOR RIGHT** $\>$ button to display the **Features** menu.
- 4 Press the **CURSOR UP** \wedge or **CURSOR DOWN** \vee buttons to scroll through the on-screen menu until the word **Timer** is highlighted.
- 5 With **Timer** highlighted, press the **CURSOR RIGHT** $\>$ button to display the **Timer** menu.
- 6 Press the **CURSOR UP** \wedge or **CURSOR DOWN** \vee buttons to highlight the **Display Control**.
- 7 Press the **CURSOR RIGHT** $\>$ or **CURSOR LEFT** \leftarrow buttons repeatedly to select **On** or **Off**.
- 8 When finished, press the **STATUS /EXIT** button to remove the on-screen menu from the TV's screen.

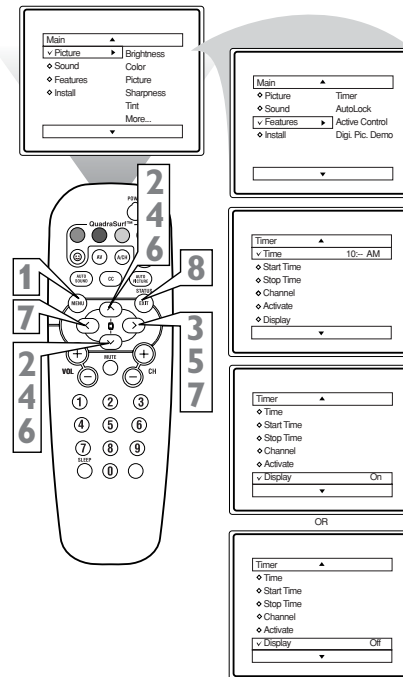

NOTE: Active Control will only appear in the menu of models 27PT6441/37 and 27PT6442/37.

The Active Control monitors and adjusts incoming video signals to help provide the best picture quality.

When you choose to turn the Active Control On, the picture sharpness and noise reduction are controlled automatically. Active Control adjusts these picture settings continuously and automatically.

NOTE: Active Control is only available in models 27PT6441/37 and 27PT6442/37.

- 1** Press the **MENU** button on the remote to show the on-screen menu.
- 2** Press the **CURSOR UP** \wedge or **DOWN** \vee buttons to scroll through the on-screen menu until the word **Features** is highlighted.
- 3** Press the **CURSOR RIGHT** $>$ button to display the **Features** menu.
- 4** Press the **CURSOR UP** \wedge or **DOWN** \vee buttons to repeatedly until **Active Control** is highlighted.
- 5** Press the **CURSOR RIGHT** $>$ or **CURSOR LEFT** $<$ buttons to toggle the Active Control On or Off.
- 6** When finished, press the **STATUS /EXIT** button to remove the on-screen menu from the TV's screen.

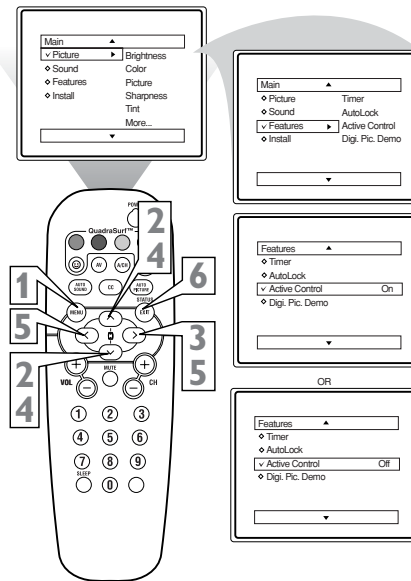

NOTE: Active Control will only appear in the menu of models 27PT6441/37 and 27PT6442/37.

The AutoLock™ feature is an integrated circuit that receives and processes data sent by broadcasters, or other program providers, that contain program content advisories. When programmed by the viewer, a TV with AutoLock™ can respond to the content advisories and block program content that may be found objectionable (such as offensive language, violence, sexual situations, etc.). This is a great feature to censor the type of viewing children may watch.

AutoLock™ offers various BLOCKING controls from which to choose:

Access Code - An Access Code must be set to prevent children from unblocking questionable or censored programming set by their parents.

Channel Block - After an access code has been programmed, you can block individual channels including the A/V inputs.

Clear All - Allows you clear all channels being blocked from your viewing set with the Channel Block Control.

Block All - Allows you to block ALL channels and A/V inputs at one time.

Movie Ratings - Certain blocking options exist which will block programming based on ratings patterned by the Motion Pictures Association of America.

TV Ratings - Just like the Movie Ratings, programs can be blocked from viewing using standard TV ratings set by TV broadcasters.

MOVIE RATINGS

G: General Audience - All ages admitted. Most parents would find this program suitable for all ages.

PG: Parental Guidance Suggested - This programming contains material that parents may find unsuitable for younger children.

PG-13: Parents Strongly Cautioned - This programming contains material that parents may find unsuitable for children under the age of 13.

MOVIE RATINGS Continued

R: Restricted - This is programming is specifically designed for adults. Anyone under the age of 17 should only view this programming with an accompanying parent or adult guardian.

NC-17: No one under the age of 17 will be admitted. - This type of programming should be viewed by adults only.

X: Adults Only - This type of programming contains one or more of the following: very graphic violence, very graphic and explicit or indecent sexual acts, very coarse and intensely suggestive language.

TV RATINGS

TV-Y -- Designed for a very young audience, including children ages 2-6.

TV-Y7 -- It may be appropriate for children age 7 and above who have acquired the development skills needed to distinguish between make-believe and reality.

TV-G -- Suitable for most audiences, this type of programming contains little or no violence, no strong language, and little or no sexual dialogue or situations.

TV-PG -- This program contains material that parents may find unsuitable for younger children. Could contain Moderate violence (V), some sexual situations (S), infrequent coarse language (L), or some suggestive dialogue (D).

TV-14 -- This program contains some material that many parents would find unsuitable for children under 14 years of age. This type of programming contains one or more of the following: intense violence (V), intense sexual situations (S), strong coarse language (L), or intensely suggestive dialogue (D).

TV-MA -- This program is specifically designed to be viewed by adults and therefore may be unsuitable for children under 17. This type of programming contains one or more of the following: graphic violence (V), explicit sexual situations (S), or crude indecent language (L).

25

SETTING UP AN ACCESS CODE

Over the next few panels you'll learn how to block channels and get a better understanding of the rating terms for certain programming.

First, let's start by learning how to set a personal access code:

- 1** Press the **MENU** button on the remote to display the on-screen menu.
- 2** Press the **CURSOR UP** \wedge or **DOWN** \vee buttons until the word **Features** is highlighted.
- 3** Press the **CURSOR RIGHT** $\>$ button to display the Features menu options.
- 4** Press the **CURSOR UP** \wedge or **DOWN** \vee buttons until the words **Auto Lock™** are highlighted.
- 5** Press the **CURSOR RIGHT** $\>$ button. The screen will read, "Access Code - - - ."
- 6** Using the **NUMBERED** buttons, enter **0, 7, 1, 1**. "XXXX" appears on the Access Code screen as you press the numbered buttons. "Incorrect" will appear on the screen, and you will need to enter **0, 7, 1, 1** again.
- 7** The screen will ask you to enter a "New Code." Enter a "new" **4 digit code** using the **NUMBERED** buttons. The screen will then ask you to **CONFIRM** the code you just entered. Enter your **new code** again. "XXXX" will appear when you enter your new code and then display the AutoLock™ menu options.

Proceed to the next panel to learn more...

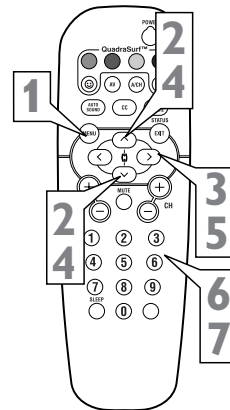
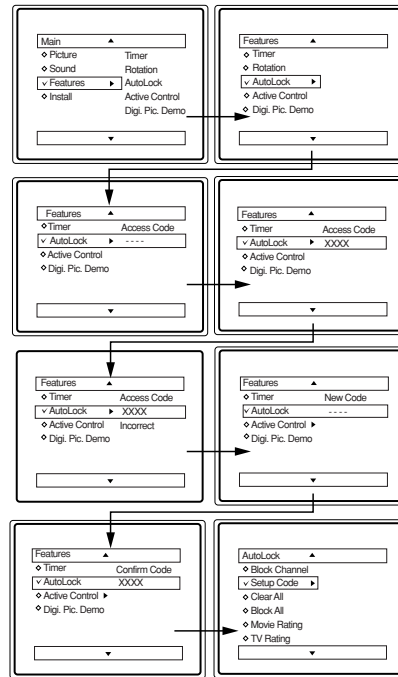

NOTE: Active Control will only appear in the menu of models 27PT6441/37 and 27PT6442/37.

26

BLOCK CHANNELS

After your personal access code has been set (see previous page), you are now ready to select the channels or the A/V Inputs you want to block out or censor. Once you've entered your access code and the AutoLock™ features are displayed on the screen:

1 Press the **CURSOR UP** \wedge or **DOWN** \vee buttons until the words **Block Channel** are highlighted.

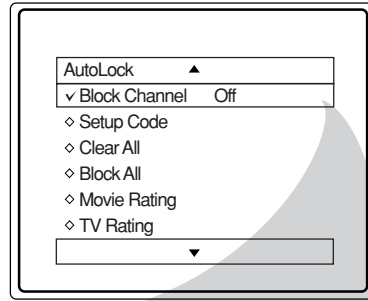

2 Press the **CURSOR RIGHT** $\>$ button to turn blocking ON or OFF for that channel. When ON is selected the channel will be blocked.

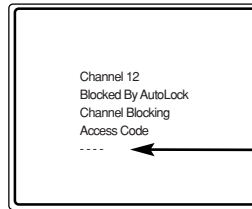

Enter your Access Code to view a tuned channel that is blocked with Block Channel.

3 Press the **CH +** or **CH -** button to select other channels you wish to block. Repeat steps 2-3 to block the new channel.

4 When finished, press the **STATUS/EXIT** button to remove the menu from the screen.

NOTE: If you ever forget your code, the 0, 7, 1, 1 code is the factory default and can be used to enter and create a new access code.

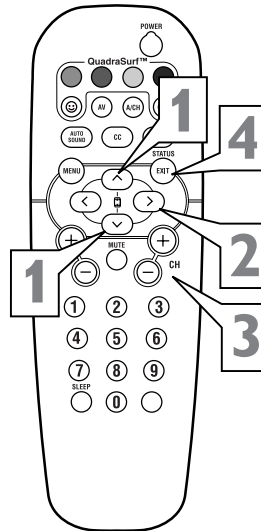

27 BLOCK/CLEAR ALL CHANNELS AT THE SAME TIME

After blocking specific channels there may come a time when you want to block or clear all the channels at the same time. Once you've entered your access code and the AutoLock™ features are displayed on the screen:

1 Press the **CURSOR UP** \wedge or **DOWN** \vee buttons to select either Clear All or Block All.

2 If **Clear All** is selected, press the **CURSOR RIGHT** $\>$ button to clear all blocked channels. All channels will be viewable.

If **Block All** is selected, press the **CURSOR RIGHT** $\>$ button to turn the control On or Off. When On is selected, ALL available channels will be blocked from viewing.

3 When finished, press the **STATUS/EXIT** button to remove the menu from the screen.

NOTE: If you ever forget your code, the 0, 7, 1, 1 code is the factory default and can be used to enter and create a new access code.

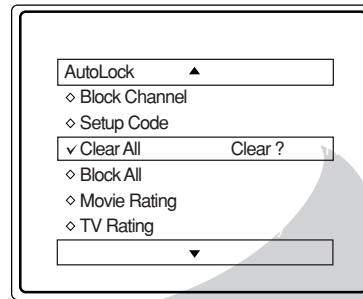

✓ Clear All Cleared

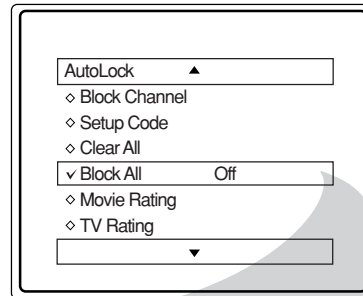

✓ Block All On

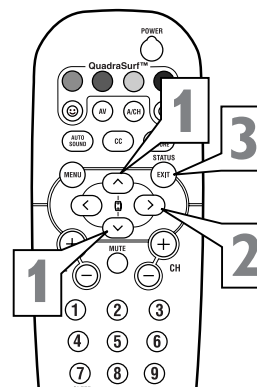

28

MOVIE RATINGS

The AutoLock™ feature can block programming based on the Movie Industry ratings. Once you've entered your access code and the AutoLock™ features are displayed on the screen:

- 1 Press the CURSOR UP ^ or DOWN v buttons** to highlight the words Movie Rating.
- 2 Press the CURSOR RIGHT > button** to display the Movie Rating options (G, PG, PG-13, R, NC17, or X).
- 3 Press the CURSOR UP ^ or DOWN v buttons** to highlight any of the Movie Rating options. When highlighted, all these options can be turned **On** (which will allow blocking) or **Off** (which will allow viewing).
- 4 Use the CURSOR RIGHT > button** on the remote to turn the rating option On or Off.

When a rating level is chosen to be blocked, any higher level rating will also be blocked from viewing. (i.e.: If "R" is selected to be blocked, NC-17 and X will automatically be blocked.)

NOTE: If you ever forget your code, the 0, 7, 1, 1 code is the factory default and can be used to enter and create a new access code.

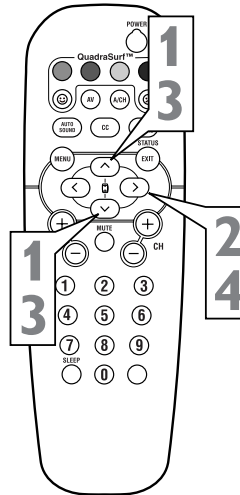
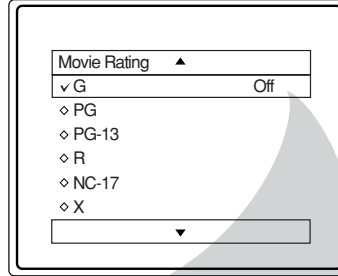
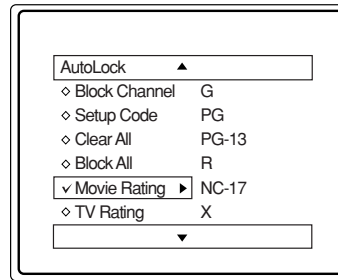

The AutoLock™ feature can block programming based on the TV Industry ratings.

Once you've entered your access code and the AutoLock™ features are displayed on the screen:

- 1 Press the **CURSOR UP** \wedge or **DOWN** \vee buttons to highlight the words TV Rating.
- 2 Press the **CURSOR RIGHT** $\>$ button to display the TV Rating options (TV-Y, TV-Y7, TV-G, TV-PG, TV-14, or TV-MA).
- 3 Press the **CURSOR UP** \wedge or **DOWN** \vee buttons to highlight any of the TV Rating options. When highlighted, all these options can be turned **On** (which will allow blocking) or **Off** (which will allow viewing).

NOTE: Some TV RATING options also have sub-ratings. The ratings of TV-Y7, TV-PG, TV-14, TV-MA can be customized to block V (violence), FV (fantasy violence), S (sexual situations), L (coarse language), or D (suggestive dialogue).

- 4 Press the **CURSOR RIGHT** $\>$ button on the remote to turn the TV-Y or TV-G rating On or Off. Or, press the **CURSOR RIGHT** $\>$ button to enter the sub-menus for the TV-Y7, TV-PG, TV-14 or TV-MA ratings.
- 5 If the TV-Y7, TV-PG, TV-14 or TV-MA sub-menu is accessed, press the **CURSOR UP** \wedge or **DOWN** \vee buttons to select one of the options (Block All, V, S, L, D, or FV).
- 6 Press the **CURSOR RIGHT** $\>$ button on the remote to turn the option ON or OFF.

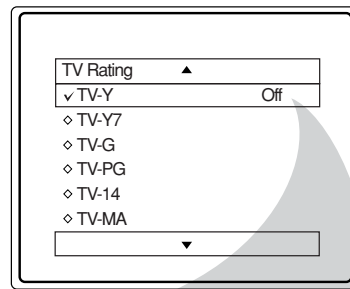

✓ TV-Y	On
✓ TV-Y7	▶ Block All, FV
✓ TV-G	Off
✓ TV-PG	▶ Block All, V, S, L, D
✓ TV-14	▶ Block All, V, S, L, D
✓ TV-MA	▶ Block All, V, S, L

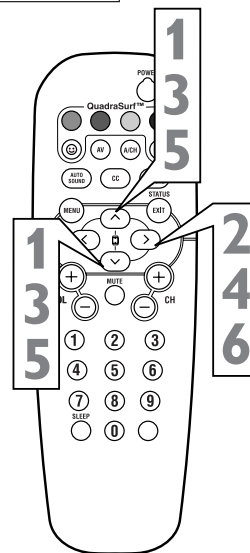

AutoLock™ offers the viewer other blocking features as well. With these Blocking Options, the censoring can be turned ON or OFF.

Once you've entered your access code and the AutoLock™ features are displayed on the screen:

- 1** Press the **CURSOR UP** \wedge or **DOWN** \vee buttons until the words **Block Options** are highlighted.
- 2** Press the **CURSOR RIGHT** $\>$ button to display the **Blocking Options (Blocking, Unrated, or No Rating)** menu.

Blocking: Might be called the “master switch” for AutoLock™. When On, ALL blocking/censoring will take place. When Off, ALL blocking is disabled.

Unrated: ALL unrated programs based on the Movie Ratings or Parental (TV) Guidelines can be blocked if this feature is set to On and the Blocking feature is set to OFF.

No Rating: ALL programming with NO content advisory data can be blocked if set to On and the Blocking feature is set to OFF.

- 3** Press the **CURSOR UP** \wedge or **DOWN** \vee buttons to highlight the desired feature.
- 4** When highlighted, each feature can be turned **On** or **Off** using the **CURSOR RIGHT** $\>$ or the **CURSOR LEFT** $\<$ buttons on the remote.

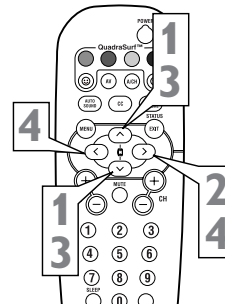
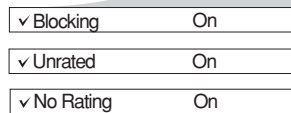
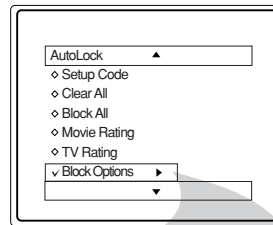

DEMO MODE

With Demo Mode On, a split screen demo will be shown on the screen. The Demo Mode will show the right side with a sharper image with more natural motion.

- 1** Press the **MUTE** button on the remote approximately 3-4 seconds. The split screen demo appears. After 20 seconds, the TV will automatically return to normal operation.

Note: You can also turn the Digital Picture Demo On or Off by using on-screen menu.

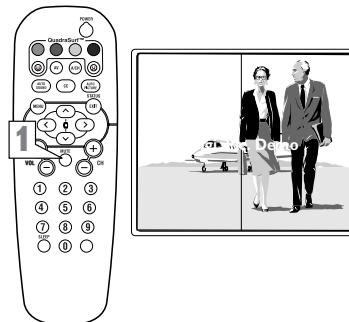

31

CLOSED CAPTIONING

Closed Captioning (CC) allows you to read the voice content of television programs on the TV screen. Designed to help the hearing impaired, this feature uses on-screen "text boxes" to show dialogue and conversations while the TV program is in progress.

- 1** Press the **CC** button on the remote to display the current Closed Caption setting.
- 2** Press the **CC** button repeatedly to choose from the four Closed Caption options (CC Off, CC1, CC2, CC Mute).
- 3** When finished, press the **STATUS /EXIT** button to remove the menu from the TV's screen.

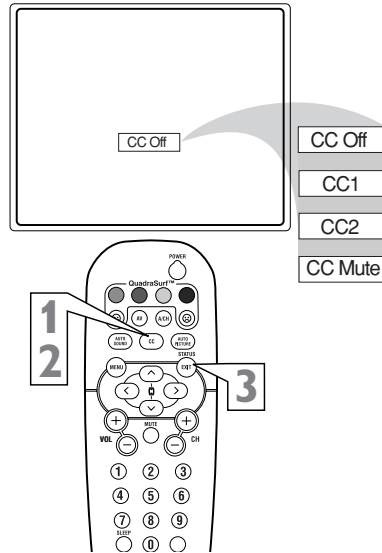

SLEPTIMER

Your TV can be set to automatically turn itself off at a given amount of time.

- 1** Press the **SLEEP** button on the remote control and the **SLEEP** timer display will appear on the screen.
- 2** Press the **SLEEP** button repeatedly to pick the amount of time (15, 30, 45, 60, 90, 120, 180, or 240 minutes) before the TV will turn itself off.

NOTE: An on-screen count down will appear during the last minute before the TV shuts itself off. If any button is pressed during the last minute of the countdown, the Sleptimer setting will be cancelled.

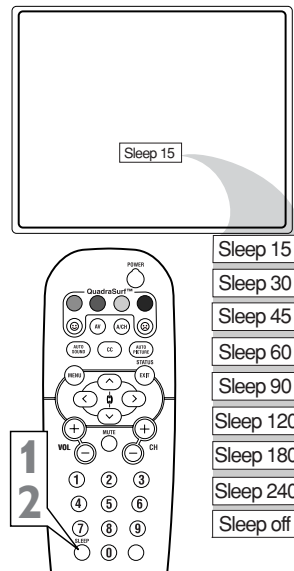

Whether you're watching a movie or a sporting event, your TV has automatic video control settings matched for your current program source or content.

- 1 Press the **AUTO PICTURE** button on the remote control. The current Auto Picture setting will be displayed on the screen.
- 2 Press the **AUTO PICTURE** button repeatedly to select either Personal, Movies, Sports, Weak Signal, or MULTIMEDIA picture settings.

NOTE: The way you choose to set the Picture Menu Controls will become your Personal setting.

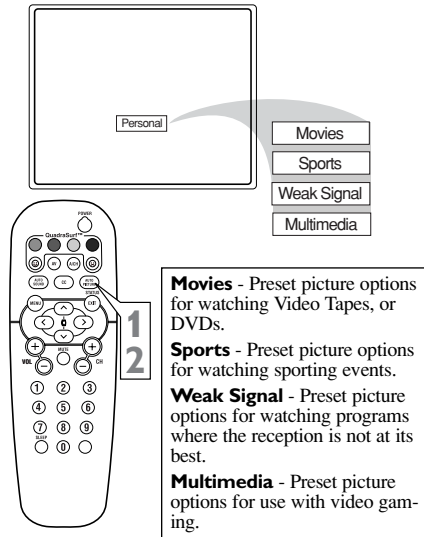

AUTO SOUND

The Auto Sound feature allows the listener to select between four different factory set sound options.

- 1 Press the **AUTO SOUND** button on the remote control. The current Auto Sound setting will appear in the middle of the screen.
- 2 Press the **AUTO SOUND** button repeatedly to toggle between the four settings. (Personal, Theatre, Music, or Voice)

NOTE: The way you choose to set the Sound Menu Controls will become your Personal setting.

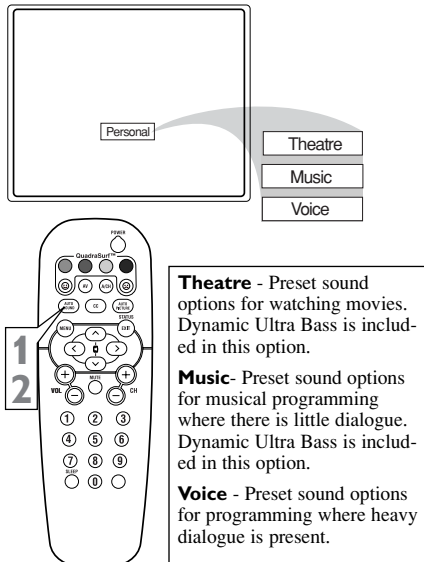

The QuadraSurf™ control allows you set up four different personal channel Surf lists using the colored buttons (on the remote control), each holding up to ten channels in its quick viewing “list.”

- 1 Press the CHANNEL (+) or (-) buttons (or the NUMBER buttons) to select a channel to add to one of the SURF lists.
- 2 Press the SMILEY 😊 button on the remote control to ADD the channel to one of the SURF lists.
- 3 Press the corresponding COLORED (Red, Green, Yellow or Blue) button to add the channel to that button’s Surf list. (Up to ten channels per button can be stored.)

Repeat steps 1 through 3 to add additional channels (up to 10) to each of the SURF lists.

To remove a channel from one of the SURF lists;

- 4 Press the COLORED Quadra Surf button until the desired channel appears. The screen will display the channel number with a colored “Smiley” face to indicate the Colored button it relates to.
- 5 While the “Smiley” face channel indicator is displayed, press the FROWNIE ☹️ face button. The screen will read, “Remove item? - Press ☹️.”
- 6 Press the FROWNIE ☹️ face button again to confirm your decision to remove the channel from the Surf list.

Repeat steps 4-6 to remove other channels from Surf lists.

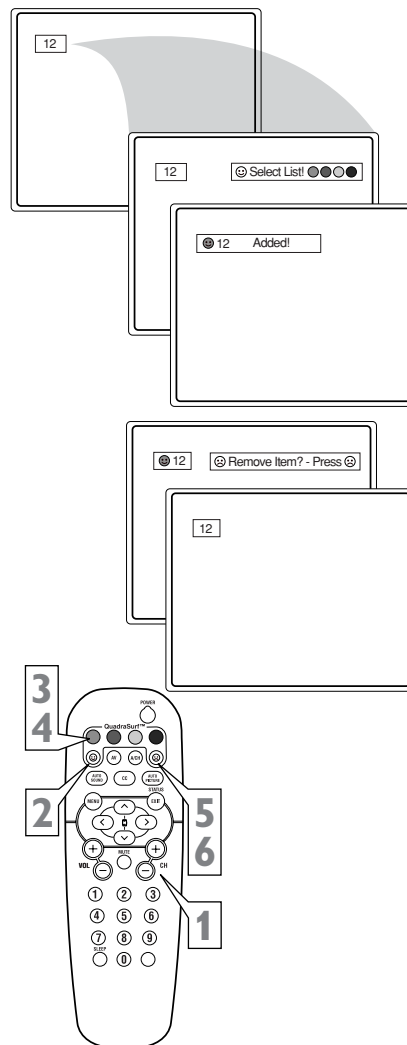

The Quadra Surf buttons on your remote control allow you to store up to 10 channels per button (40 total). You can even program the A/V Input channels for each button making them a “source” button.

Assuming channels have now been added to the four Quadra Surf lists (the four colored buttons, see the previous page), let's review how the feature works.

- 1** Press one of the pre-programmed COLORED buttons on the remote (Red, Green, Yellow or Blue). The screen will display a smiley face with the first programmed channel for that surf list.
- 2** While the colored “smiley” face still appears on the screen, press the same COLORED button on the remote to tune the second channel programmed for that specific surf list.
- 3** Repeatedly pressing the same COLORED button while the “smiley” face appears will tune all the programmed channels. Pressing the COLORED button again will return you to the first channel in the list.

If the “smiley” face disappears from the screen and the same COLORED button is pressed, the surf channels will be displayed starting with the FIRST programmed channel again.

- 4** Repeat steps 1-3 for the other three COLORED buttons (Surf lists) if desired.
- 5** Any time the “smiley” face appears with the channel number, pressing the “frownie” face button will allow you to remove it from the list (see the previous page for more details).

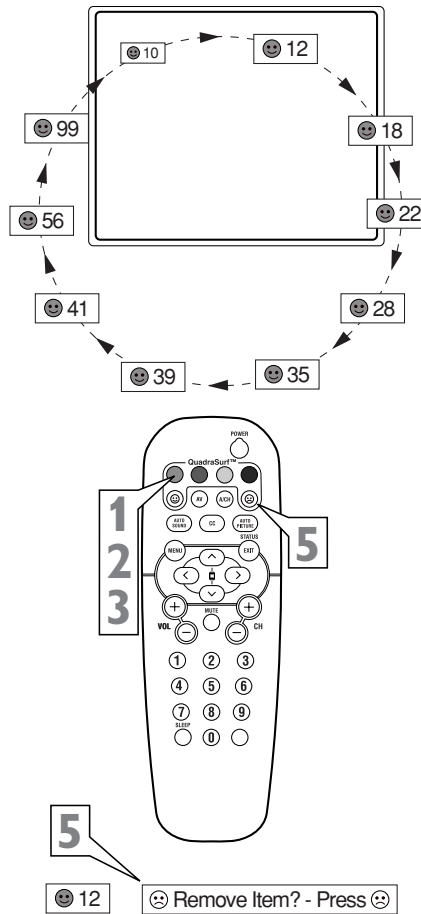

No Power

- Check the TV power cord. Unplug the TV, wait 10 seconds, then reinsert the plug into the outlet and push the POWER button again.
- Check that the outlet is not on a wall switch.
- Be sure the fuse is not blown on the AC power strip, if one is being used.

No Picture

- Check antenna connections. Are they properly secured to the TV's ANT 75Ω plug?
- Check the TUNER MODE control for the correct tuner setting.
- Try running the Auto Program feature to find all available channels.
- Press the AV button on the remote to make sure the correct signal source is selected (FRONT or Current Channel).

No Sound

- Check the VOLUME buttons.
- Check the MUTE button on the remote control.
- If you're attempting to hook up auxiliary equipment, check the audio jack connections located on the front of the TV.

Remote Does Not Work

- Check the batteries. If necessary, replace them with AA Heavy Duty (Zinc Chloride) or Alkaline batteries.
- Clean the remote control and the remote control sensor window on the TV.
- Check the TV power cord. Unplug the TV, wait 10 seconds, then reinsert the plug into the outlet and push the POWER button again.
- Be sure the fuse is not blown on the AC power strip, if one is being used.
- Check to be sure the TV outlet is not on a wall switch.

TV Displays Wrong Channel or No Channels Above 13

- Repeat channel selection.
- Add the desired channel numbers (using the CHANNEL EDIT control) into the TV's memory.
- Check to be sure the TUNER MODES are set to the CABLE option and run the Auto Program feature to find all available channels.

WARNING Concerning Stationary Images on the TV Screen:

Do not leave stationary or letterbox images on screen for extended periods of time. This can cause uneven picture-tube aging.

Normal use of the TV should involve the showing of pictures that contain constantly moving and changing images that fill the screen. Be careful not to leave nonmoving images on screen for extended periods of time, or to display the same images on screen too frequently, because subtle ghost images can be left on the picture tubes. Sources of stationary images may be DVD disks, laser disks, video games, CD-i disks, videotapes, digital television boxes, broadcast channels, cable channels, satellite channels, and others. **Here are some examples of stationary images (this is not an all-inclusive list; you may encounter others in your viewing):**

- **DVD menus**—listings of DVD disk content
- **Letterbox black bars**—shown at the top and bottom of the TV screen when a wide screen (16:9) movie is viewed on a TV with standard (4:3) aspect ratio.
- **Video-game images and scoreboards**
- **Television station logos**—present a problem if they are bright and stationary; moving or low-contrast graphics are less likely to cause uneven aging of the picture tube
- **Stock-market tickers**—presented at the bottom of the TV screen
- **Shopping channel logos and pricing displays**—bright and shown constantly or repeatedly in the same location on the TV screen.

Placement of the TV

- To avoid cabinet warping, cabinet color changes, and increased chance of set failure, do not place the TV where temperatures can become excessively hot; for example, in direct sunlight or near a heating appliance.
- Be sure to allow a free flow of air to and from the perforated back cover of the set.

Cleaning

- To avoid possible shock hazard, be sure the TV is unplugged from the electrical outlet before cleaning.
- Regularly dust the TV with a dry, nonscratching duster to keep the TV clean.
- When cleaning the TV, take care not to scratch or damage the screen surface. Avoid wearing jewelry or using anything abrasive. Do not use household cleaners. Wipe the front screen with a clean cloth dampened with water. Use even, easy, vertical strokes when cleaning.
- Gently wipe the cabinet surfaces with a clean cloth or sponge dampened in a solution of cool, clear water and a mild soap or detergent. Use a clean, dry cloth to dry the wiped surfaces.
- Occasionally vacuum the ventilation holes or slots in the back cover of the set.
- Never use thinners, insecticide sprays, or other chemicals on or near the cabinet, as they might cause permanent marring of the cabinet finish.

**RENEWED
90 DAY
LIMITED WARRANTY**