

Register your product and get support at
www.philips.com/welcome

21PT9460/44

21PT9460/55



EN User manual

PHILIPS

1 Important

Read and understand all instructions before you use your TV. If damage is caused by failure to follow instructions, the warranty does not apply.

Safety

Risk of electric shock or fire!

- Never expose the TV to rain or water. Never place liquid containers, such as vases, near the TV. If liquids are spilt on or into the TV, disconnect the TV from the power outlet immediately. Contact Philips Consumer Care to have the TV checked before use.
- Never place the TV, remote control or batteries near naked flames or other heat sources, including direct sunlight. To prevent the spread of fire, keep candles or other flames away from the TV, remote control and batteries at all times.



- Never insert objects into the ventilation slots or other openings on the TV.

Risk of short circuit or fire!

- Never expose the remote control or batteries to rain, water or excessive heat.
- Avoid force coming onto power plugs. Loose power plugs can cause arcing or fire.

Risk of injury or damage to the TV!

- Two people are required to lift and carry a TV that weighs more than 55 lbs.
- If the TV is transported in temperatures below 5°C, unpack the TV and wait until the TV temperature matches room temperature before connecting the TV to the power outlet.

- Before you connect the TV to the power outlet, ensure that the power voltage matches the value printed on the back of the TV. Never connect the TV to the power outlet if the voltage is different.

Risk of injury to children! Follow these precautions to prevent the TV from toppling over and causing injury to children:

- Never place the TV on a surface covered by a cloth or other material that can be pulled away.
- Ensure that no part of the TV hangs over the edge of the surface.
- Never place the TV on tall furniture (such as a bookcase) without anchoring both the furniture and TV to the wall or a suitable support.
- Educate children about the dangers of climbing on furniture to reach the TV.

Risk of overheating!

- Never install the TV in a confined space. Always leave a space of at least 4 inches or 10 cm around the TV for ventilation. Ensure curtains or other objects never cover the ventilation slots on the TV.

Risk of injury, fire or power cord damage!

- Never place the TV or any objects on the power cord.
- To easily disconnect the TV power cord from the power outlet, ensure that you have full access to the power cord at all times.
- When you disconnect the power cord, always pull the plug, never the cable.
- Disconnect the TV from the power outlet and antenna before lightning storms. During lightning storms, never touch any part of the TV, power cord or antenna cable.

Screen care

- Avoid stationary images as much as possible. Stationary images are images that remain on-screen for extended periods of time. Examples include: on-screen menus, black bars and time displays. If you must use stationary images, reduce screen contrast and brightness to avoid screen damage.
- Unplug the TV before cleaning.
- Clean the TV and frame with a soft, damp cloth. Never use substances such as alcohol, chemicals or household cleaners on the TV.
- Risk of damage to the TV screen! Never touch, push, rub or strike the screen with any object.
- To avoid deformations and color fading, wipe off water drops as soon as possible.

Disposal of your old product and batteries



Your product is designed and manufactured with high quality materials and components, which can be recycled and reused.



When this crossed-out wheeled bin symbol is attached to a product it means that the product is covered by the European Directive 2002/96/EC. Please inform yourself about the local separate collection system for electrical and electronic products.

Please act according to your local rules and do not dispose of your old products with your normal household waste.

Correct disposal of your old product helps to prevent potential negative consequences for the environment and human health.



Your product contains batteries covered by the European Directive 2006/66/EC, which cannot be disposed with normal household waste.

Please inform yourself about the local rules on separate collection of batteries because correct disposal helps to prevent negative consequences for the environmental and human health.

2 Your product

Congratulations on your purchase, and welcome to Philips! To fully benefit from the support that Philips offers, register your product at www.philips.com/welcome.

Product overview

This section gives you an overview of commonly used controls and functions.

Remote control

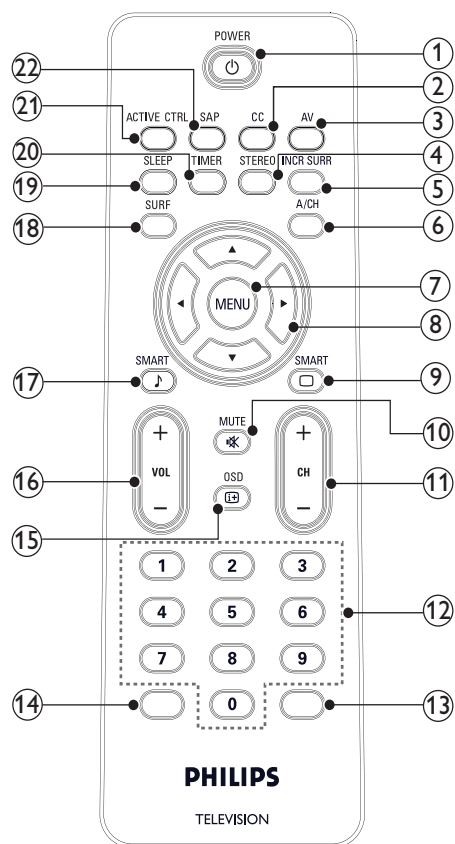

- ① **Power**
 - Switches the TV to standby if it is on.
 - Switches on the TV if it is in standby.
- ② **Close caption**
Displays closed captions settings.
- ③ **AV**
Selects connected devices.
- ④ **Stereo**
Switches Stereo and Nicam Stereo to Mono.
- ⑤ **INCR. SURR.**
Not used.
- ⑥ **A/CH**
Toggles between the current channel and the last viewed channel.
- ⑦ **MENU**
Toggles the main menu on or off.
- ⑧ **▲▼◀▶ (Navigation buttons)**
Navigates menus.
- ⑨ **□ SMART (Smart picture)**
Cycles through pre-defined picture settings.
- ⑩ **⊘ MUTE**
Mutes or restores audio output.
- ⑪ **CH +/- (Channel +/-)**
Switches to the next or previous channel.
- ⑫ **0-9 (Numeric buttons)**
Selects a channel or setting.
- ⑬ **Not used.**
- ⑭ **Not used.**
- ⑮ **ⓘ OSD**
Displays program information, if available.
- ⑯ **VOL +/- (Volume +/-)**
Increases or decreases volume.
- ⑰ **♪ SMART (Smart Sound)**
Cycles through pre-defined sound settings.
- ⑱ **Not used.**

- ①9 **SLEEP**
Sets a delay after which the TV switches to standby.
- ②0 **TIMER**
Sets the timers.
- ②1 **Not used.**
- ②2 **SAP**
Selects Secondary Audio Program (SAP), stereo or mono.

Controls and indicators

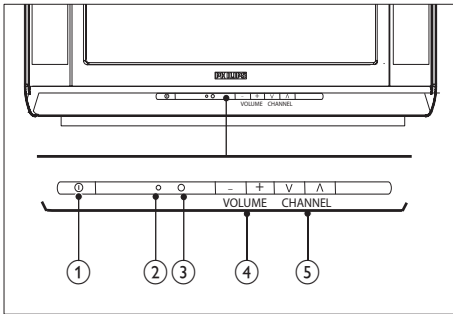

- ① **⏻**: Switches the product on or off.
- ② **Standby indicator**
- ③ **Remote control sensor**
- ④ **VOLUME +/-** : Increases or decreases volume.
- ⑤ **CHANNEL ∇/▲**: Switches to the next or previous channel.

Back connectors

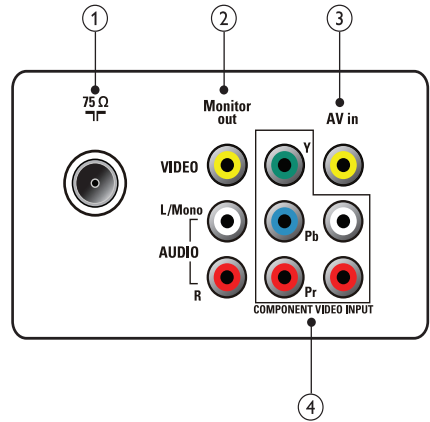

- ① **TV ANTENNA**
Signal input from an antenna, cable or satellite.
- ② **MONITOR OUT**
Audio and video output to analog devices such as another TV or a recording device.
- ③ **AV IN (VIDEO and AUDIO L/R)**
Analog audio and video input from analog or digital devices such as DVD players, satellite receivers and VCRs.
- ④ **Component Video Input (YPbPr)**
Video input from analog devices such as DVD, receiver, game console, etc. This connector is used with audio input.

Side connectors

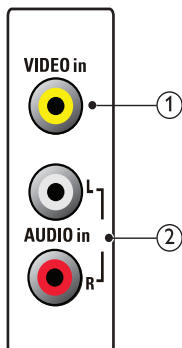

- ① **VIDEO IN**
Composite video input from analog devices such as VCRs.
- ② **AUDIO IN L/R**
Audio input from analog devices connected to **VIDEO**.

3 Get started

Connect devices

This section describes how to connect various devices with different connectors.

Note

- Different types of connectors may be used to connect a device to your TV, depending on availability and your needs.

Connect devices

Connect a video player:

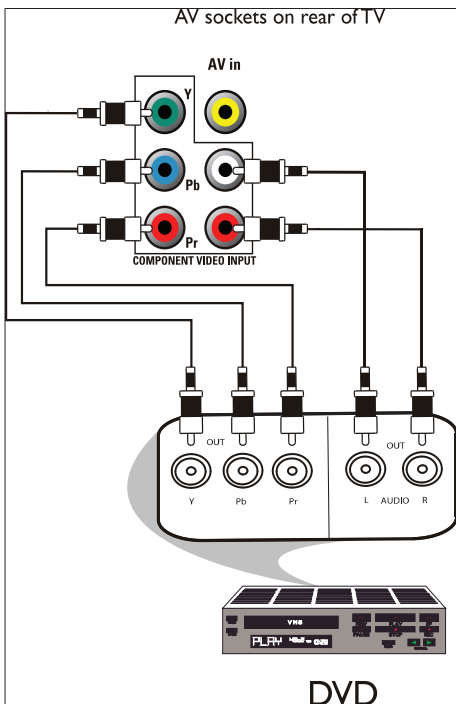

Connect a video recorder:

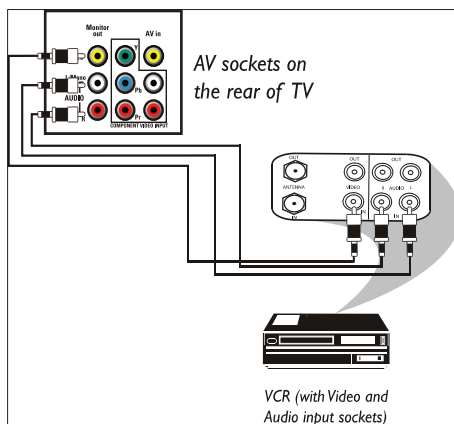

Connect a video recorder and a set-top box:

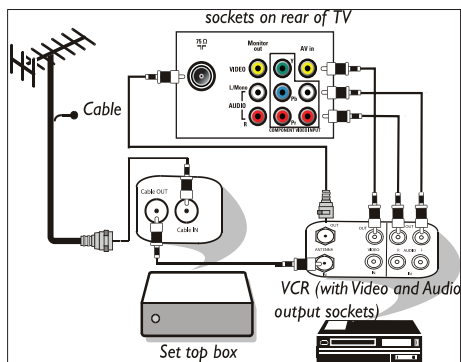

Insert remote control batteries

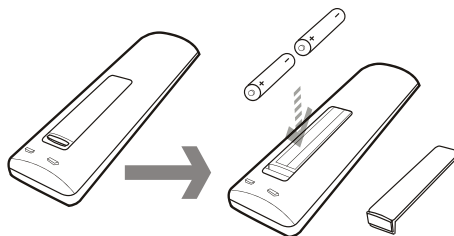

4 Install channels

Automatically install channels

This section describes how to search and store channels automatically.

Note

- Make sure the TV is in TV mode.

- 1 Press **MENU**.
- 2 Select **[Install]** > **[Auto Program]**.
- 3 Press **▶** to start auto search.
- 4 Press **MENU** to exit and return to the previous menu.

Manually install channels

This section describes how to search and store analog TV channels manually.

Note

- Make sure the TV is in TV mode.



- 1 Press **MENU**.
- 2 Select **[Install]** > **[Manual]** > **[Channel No.]**.
- 3 Press **◀▶** or the numeric buttons to key in the channel number.
- 4 Press **▼** to select **[Color System]**. Press **◀▶** to select your desired color system.
- 5 Press **▼** to select **[Fine Tune]**. Press **◀▶** to adjust.
- 6 Press **▼** to select **[Store?]**. Press **◀▶** to select **[Stored]**.
- 7 Press **▼** to select **[Skipped]**. Press **◀▶** to select **[On]** to skip channel.
- 8 Press **MENU** to exit and return to the previous menu.

5 Use your product

This section helps you perform basic operations (see 'Use more of your product' on page 9).

Switch your TV on/off or to standby

To switch on

- If the standby indicator is off, press  at the front of the TV.
- If the standby indicator is red, press  on the remote control.

To switch to standby

- Press  on the remote control.
↳ The standby indicator switches to red.

To switch off

- Press  at the front of the TV.
↳ The standby indicator switches off.

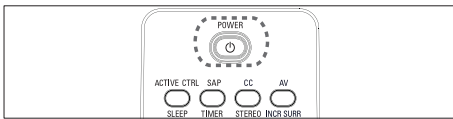

Tip

- Though your TV consumes very little power when in standby, energy continues to be consumed. When not in use for an extended period of time, disconnect the TV power cable from the power outlet.

Switch channels

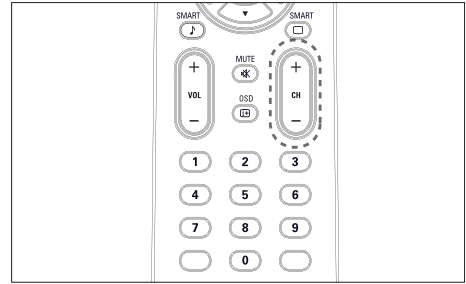

- Press **CH +/-** on the remote control or ∇ / \wedge at the front of the TV.
- Enter a channel number using the **Numeric buttons**.

Watch connected devices

Use the source button

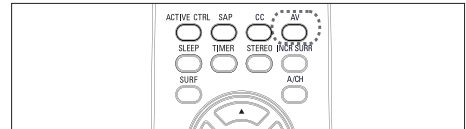

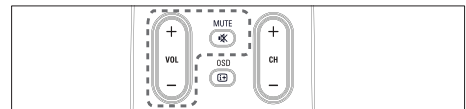

Press **AV** repeatedly to cycle through the various sources.

Adjust TV volume



To increase or decrease volume

- Press **VOL +/-**.
- Press +/- at the front of the TV.
- Press  to mute the sound.
- Press  again to restore the sound.

6 Use more of your product

Access TV menus

Menus help you to install channels, change picture and sound settings and access other features.

- 1 Press **MENU**.
↳ The menu screen appears.

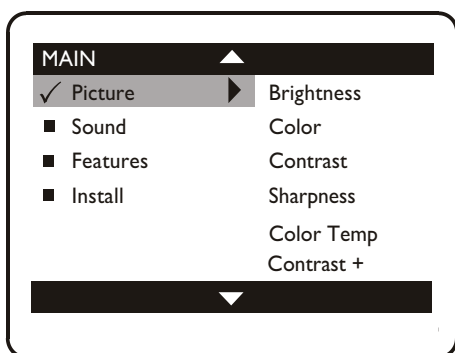

- 2 Press the **▲▼◀▶** to select and navigate through one of the following menus.
 - **[Picture]** Adjusts the picture setting for optimal viewing.
 - **[Sound]** Adjusts the sound setting.
 - **[Features]** Accesses features.
 - **[Install]** Selects the channel installation menu.
- 3 Press **OK** to confirm your choice.

Change picture and sound settings

Change picture and sound settings to suit your preferences. You can apply pre-defined settings or change settings manually.

Use smart picture

Use smart picture to apply pre-defined picture settings.



- 1 Press **SMART** repeatedly to cycle through the four settings.
 - **[Personal]** Settings are set to your preference.
 - **[Soft]** Emphasizes warm colours. This setting is suitable for dimly lit rooms.
 - **[Natural]** Emphasizes original colors.
 - **[Rich]** Emphasizes vibrant colours. This setting is the optimal setting when you are viewing TV programmes in a brightly lit room.
- 2 Press **EXIT** to exit.

Manually adjust picture settings

- 1 Press **MENU**.
- 2 Press the navigation buttons to enter the **[Picture]** menu.
- 3 Press **▲▼◀▶** to select from the following settings and adjust:
 - **[Brightness]** Adjusts the intensity and details of dark areas.
 - **[Color]** Adjusts color saturation.
 - **[Contrast]** Adjusts the intensity of bright areas, keeping dark areas unchanged.
 - **[Sharpness]** Adjusts the level of sharpness in image details.

- **[Color Temp]**Introduces more orange tones or blue tones to the picture.
- **[Contrast +]**Optimizes the total contrast for improved picture quality.

Use smart sound

Use smart sound to apply pre-defined sound settings.

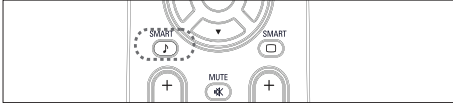

- 1 Press **SMART** repeatedly to cycle through the four settings.
 - **[Personal]**Settings are set to your preference.
 - **[Voice]**Emphasizes high tones (treble boosted).
 - **[Theater]**Emphasizes sensation to action (bass and treble boosted).
 - **[Music]**Emphasizes low tones (bass boosted).
- 2 Press **EXIT** to exit.

Adjust sound settings

- 1 Press **MENU**.
- 2 Press the navigation buttons to enter the **[Sound]** menu.
- 3 Press **▲▼◀▶** to select from the following settings and adjust:
 - **[Treble]**Adjusts the treble level.
 - **[Bass]**Adjusts the bass level.
 - **[Balance]**Adjusts the balance of the right and left speakers to best suit your listening position.
 - **[Incr. Surround]**Enables spatial sound.
 - **[System]**Sets system sound.

Use timers

You can set timers to switch the TV to standby at a specified time.

Set the time

- 1 Press **MENU**.
- 2 Select **[Features]** > **[Timer]** > **[Time]**.
- 3 Press the numeric buttons to set the time.
- 4 Press **EXIT** to exit.

Set timer options

- 1 Press **MENU**.
- 2 Select **[Features]** > **[Timer]**.
- 3 Press **▲▼** to select from the following options and adjust:
 - **[Start Time]**Sets the time for the TV to turn on from standby.
 - **[Start Channel]**Sets the channel when the TV is turned on from standby.
 - **[Switch Time]**Sets a time for the TV to switch to another channel.
 - **[Switch Channel]**Sets a channel to switch to when the TV is programmed to switch to another channel.
 - **[Stop Time]**Sets a time for the TV to switch off.
 - **[Activate]**Activates the timer.
- 4 Press **EXIT** to exit.

7 Troubleshooting

This section describes commonly encountered issues and accompanying solutions.

General TV issues

The TV does not switch on:

- Disconnect the power cable from the power outlet. Wait for one minute then reconnect it.
- Check that the power cable is securely connected.

The remote control is not working properly:

- Check that the remote control batteries are correctly inserted according to the +/- orientation.
- Replace the remote control batteries if they are flat or weak.
- Clean the remote control and TV sensor lens.

The standby light on the TV blinks red:

- Disconnect the power cable from the power outlet. Wait until the TV cools down before reconnecting the power cable. If the blinking reoccurs, contact Philips Consumer Care.

The TV menu is in the wrong language.

- Change the TV menu to your preferred language.

When turning the TV on/off/to standby, you hear a creaking sound from the TV chassis:

- No action is required. The creaking sound is normal expansion and contraction of the TV as it cools and warms up. This does not impact performance.

Picture issues

The TV is on, but there is no picture:

- Check that the antenna is properly connected to the TV.
- Check that the correct device is selected as the TV source.

There is sound but no picture:

- Check that the picture settings are correctly set.

There is poor TV reception from an antenna connection:

- Check that the antenna is properly connected to the TV.
- Loud speakers, unearthed audio devices, neon lights, high buildings and other large objects can influence reception quality. If possible, try to improve the reception quality by changing the antenna direction or moving devices away from the TV.
- If reception on only one channel is poor, fine tune this channel.

There is poor picture quality from connected devices:

- Check that the devices are connected properly.
- Check that the picture settings are correctly set.

Sound issues

There is picture but no sound from the TV:

- Check that all cables are properly connected.
- Check that the volume is not set to 0.
- Check that the sound is not muted.

There is picture but sound quality is poor:

- Check that the sound settings are correctly set.

There is picture but sound comes from one speaker only:

- Verify that sound balance is set to the center.

Contact us

If you cannot resolve your problem, refer to the FAQs for this TV at www.philips.com/support.

If the problem remains unresolved, contact Philips Consumer Care in your country.



Warning

- Do not attempt to repair the TV yourself. This may cause severe injury, irreparable damage to your TV or void your warranty.



Note

- Make a note of your TV model and serial number before you contact Philips. These numbers are printed on the back of the TV and on the packaging.

8 Product information

Product information is subject to change without notice. For detailed product information, go to www.philips.com/support.

Picture

Diagonal screen size: 53cm
Visible diagonal screen size: 51cm

Tuner/Reception/ Transmission

- Antenna input: 75ohm coaxial
- TV system: PAL-M, PAL-N, NTSC-M
- Video playback: NTSC, PAL

Remote control

- Batteries: 2 x AAA (LR03 type)

Connections

- CVI
- CVBS In
- Monitor Out
- Antenna
- Side CVBS In

Power

- Mains power: AC 110-240V, 50-60Hz
- Power consumption: 74W
- Standby power: < 3W

9 Notice

2010 © Koninklijke Philips Electronics N.V. All rights reserved.

Specifications are subject to change without notice. Trademarks are the property of Koninklijke Philips Electronics N.V. or their respective owners. Philips reserves the right to change products at any time without being obliged to adjust earlier supplies accordingly. The material in this manual is believed adequate for the intended use of the system. If the product, or its individual modules or procedures, are used for purposes other than those specified herein, confirmation of their validity and suitability must be obtained. Philips warrants that the material itself does not infringe any United States patents. No further warranty is expressed or implied. Philips cannot be held responsible neither for any errors in the content of this document nor for any problems as a result of the content in this document. Errors reported to Philips will be adapted and published on the Philips support website as soon as possible.

Warranty

No components are user serviceable. Do not open or remove covers to the inside of the product. Repairs may only be done by Philips Service Centres and official repair shops. Failure to do so shall void any warranty, stated or implied.

Any operation expressly prohibited in this manual, any adjustments, or assembly procedures not recommended or authorised in this manual shall void the warranty.

Compliance with EMF

Koninklijke Philips Electronics N.V. manufactures and sells many products targeted at consumers, which, like any electronic apparatus, in general have the ability to emit and receive electromagnetic signals.

One of Philips' leading Business Principles is to take all necessary health and safety measures for our products, to comply with all applicable legal requirements and to stay well within the EMF standards applicable at the time of producing the products.

Philips is committed to develop, produce and market products that cause no adverse health effects. Philips confirms that if its products are handled properly for their intended use, they are safe to use according to scientific evidence available today.

Philips plays an active role in the development of international EMF and safety standards, enabling Philips to anticipate further developments in standardisation for early integration in its products.

Copyright

All other registered and unregistered trademarks are the property of their respective owners.



© 2010 Koninklijke Philips Electronics N.V.

All rights reserved.

Document order number: 0700-21U0E000-00