

Colour television

**21PT3323
21PT4223**

Operating Instructions



PHILIPS

TABLE OF CONTENTS

Introduction

Safety Information/Useful Tips	3
Before Calling Service	4

Basic Installation/Functions

Hooking Up Your TV (Basic Connection)	5
Use/Care of remote Control	5
Connecting the Audio/Video Sockets (Playback)	6
Connecting the Audio/Video Sockets (Recording)	8
Functions of Remote Control	9
Functions of TV Controls	11

TV Installation

Selecting the Menu Language.....	12
Automatic Tuning of Channels	13
Manual Tuning of Channels	14
Selecting the Colour/Sound System	16
Fine Tuning Of Channels	17
Editing of Channels.....	18

Features

Adjusting the TV Picture	19
Adjusting the TV Sound (for 21PT4223).....	20
Adjusting the TV Sound (for 21PT3323).....	21
Using the Screen Format	22
Activating the Signal Strength	23
Using the Active Control (for 21PT4223).....	24
Smart Picture Control	25
Smart Sound Control.....	26
Personal Zapping	27
Teletext (for certain models only).....	28

General

Specifications.....	30
---------------------	----



Recycling Directive – To minimise harm to the environment, the batteries supplied with the TV set do not contain mercury or nickel cadmium. If possible, when disposing of batteries, use recycling means available to you. Your TV set uses materials which are reusable or which can be recycled. To minimise the amount of waste in the environment, specialist companies recover used sets for dismantling and collection of reusable materials (contact your dealer).

Safety Information

- Disconnect mains plug when :
 - the red light below the TV screen is flashing continuously.
 - a bright white line is displayed across the screen.
 - cleaning the TV screen. Never use abrasive cleaning agents. Use a slight damp chamois leather or soft cloth.
 - there is a lightning storm.
 - the set is left unattended for a prolonged period of time.
- No naked flame sources, such as lighted candles, should be placed on top of the TV or in the vicinity.
- Do not place your TV set under direct sunlight or heat.
- Leave at least 5 cm around each side of TV set to allow for proper ventilation.
- Avoid placing your set (e.g. near the window) where it is likely to be exposed to rain or water.
- No objects filled with liquids should be placed on top the TV so as to avoid dripping or splashing of liquids on the set.

Useful Tips

- Do not leave your set on standby mode for a prolonged period of time. Switch off set to allow it to be demagnetised. A demagnetised set supports good picture quality.
- Do not shift or move the set around when it is switched on. Unevenness in colour in some parts of the screen may occur.
- Never attempt to repair a defective TV yourself. Always consult a skilled service personnel.

BEFORE CALLING SERVICE

Below is a list of frequently occurred symptoms. Before you call for service, make these simple checks. Some of these symptoms can easily be rectified if you know what to do.

Symptom

What you should do

Colour patch
(unevenness)

- Switch off the TV by the mains power button. Wait for 20 minutes before switching on again.
 - Check the TV is not placed too near speakers or magnetic objects.
-

No power

- Check the TV's AC power cord is plugged into the mains socket. If there is still no power, disconnect plug. Wait for 60 seconds and re-insert plug. Switch on the TV again.
-

No picture

- Check the antenna connection at the rear of the TV.
 - Possible TV station problem. Try another channel.
-

Good picture
but no sound

- Try increasing the volume.
 - Check that the sound is not muted. If it is muted, press the **Mute** button on the remote control to restore sound.
-

Good sound but poor
colour or no picture

- Try increasing the contrast and brightness setting.
-

Snowish picture and
noise

- Check antenna connection at the rear of the TV.
-

Horizontal dotted lines

- Possible electrical interference e.g. hairdryer, vacuum cleaner, etc. Switch off appliances.
-

Double images or
"Ghost" images

- Possible poor positioning of antenna. Using a highly directional antenna may improve reception.
-

TV not responding to
remote control handset

- Check life span of batteries of remote control handset.
- Aim remote control handset directly at remote control sensor lens on the TV.

HOOKING UP YOUR TV (BASIC CONNECTION)

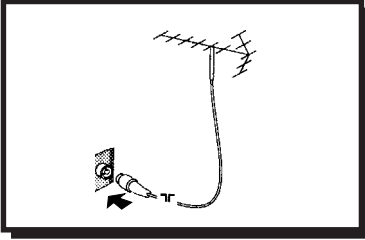

Antenna Connection

- Connect the aerial plug to the antenna socket **T** on the backcover.
- Insert the mains plug into the wall socket.

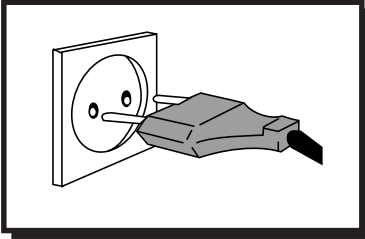

Mains Connection

- For correct mains voltage, refer to type sticker at the rear of the TV set
- Consult your dealer if mains supply is different.
Note :This diagram is not representative of the actual plug and socket.

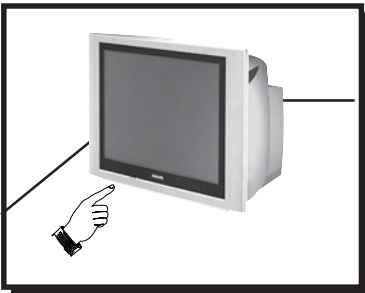

Switching on the Set

- Press the main power button to switch on/off the TV.
- If the set is on standby (indicator is red), press the **Power** button on the remote control to switch on set.

USE/CARE OF REMOTE CONTROL

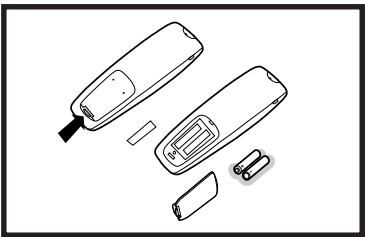

- Insert the correct type of batteries into the compartment.
- Ensure the batteries are placed in the right direction.

CONNECTING THE AUDIO/VIDEO SOCKETS (PLAYBACK)

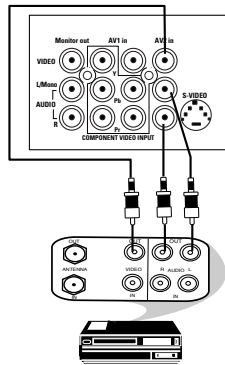

AV sockets on the rear of TV

Back of VCR

VCR (equipped with Video and Audio output sockets)

You can view the playback of VCR tapes (Video Disc players, camcorders, etc.) by using the AUDIO and VIDEO INPUT sockets on the rear of the TV.

- Connect the **VIDEO** and **AUDIO IN** sockets on the rear of the TV to the **AUDIO** and **VIDEO OUT** sockets on the VCR.

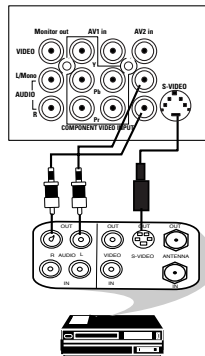

AV sockets on the rear of TV

Back of S-VHS VCR

The S-Video connection on the rear of the TV is used for the playback of S-VHS VCR tapes, Video Discs, Video Games or Compact Disc-Interactive (cd-i) discs. Better picture detail and clarity is possible with the S-Video playback as compared to the picture from a normal antenna (RF) connection.

- Connect the **S-VIDEO** socket on the rear of the TV to the **S-VHS OUT** socket on a S-VHS VCR.
- Connect the **AUDIO IN** sockets from the rear of the TV to the **AUDIO OUT** sockets on the VCR. **Note** : You need not connect the **VIDEO IN** socket of the TV if **S-VIDEO IN** socket is connected.

CONNECTING THE AUDIO/VIDEO SOCKETS (PLACKBACK)

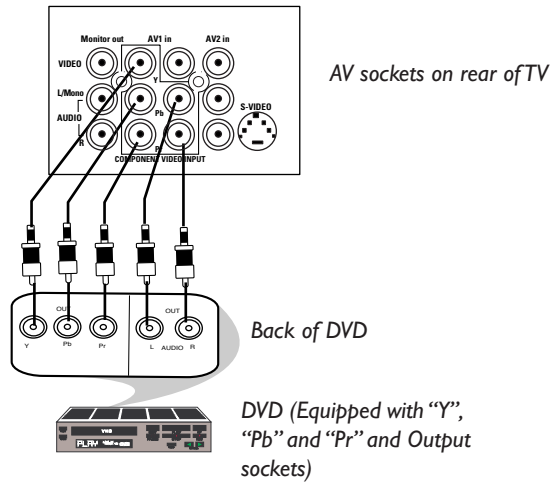

You can view the playback of DVD discs by using the COMPONENT VIDEO INPUT sockets on the rear of the TV.

- Connect the “Y”, “Pb” and the “Pr” INPUT sockets on the TV to the “Y”, “Pb” and “Pr” OUTPUT sockets on the DVD to view playback of DVD discs.

CONNECTING THE AUDIO/VIDEO SOCKETS (RECORDING)

Connection for recording from the TV channel

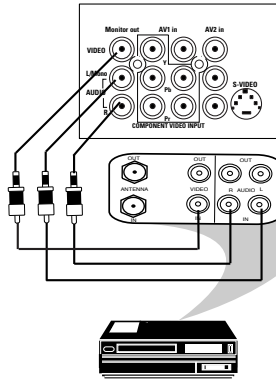

AV sockets on
the rear of TV

VCR (equipped with Video and
Audio input sockets)

- Connect the corresponding **INPUT** sockets of the VCR to the **MONITOR OUTPUT** sockets on the rear of the TV.
- To enhance the sound of your TV, connect the **AUDIO L** and **R** sockets to an external audio system instead of the VCR. For mono equipment, connect only the **AUDIO L** socket.

Connection for recording from one VCR to another VCR

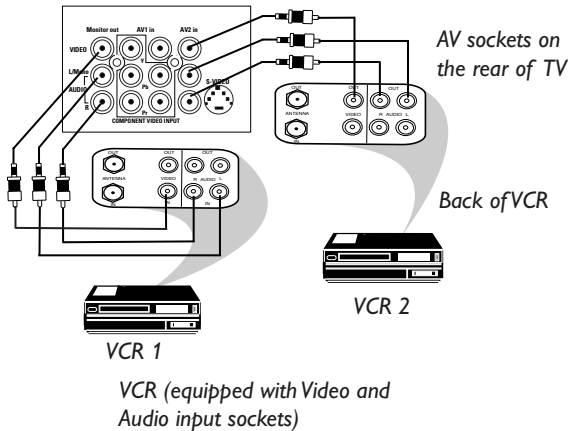

AV sockets on
the rear of TV

Back of VCR

VCR 1

VCR 2

VCR (equipped with Video and
Audio input sockets)

- Connect the sockets of the VCR which you wish to record from, to the corresponding sockets at either **AV1 or AV2**
- Connect the sockets of the receiving VCR to the **MONITOR OUTPUT** sockets on the rear of the TV.

FUNCTIONS OF REMOTE CONTROL

1 Power button

- Switch set off temporarily to standby mode. (The red light indicator lights up when the set is on standby mode).
- To switch on set from standby mode, press Channel +/- , Digit (0-9) or Power button.

2 Colour buttons

- In teletext mode, the colour buttons allow you to access directly an item or corresponding pages.
- As Personal Zapping buttons, you can surf up to 10 personal channels for each button. For detailed description of functions, refer to section on "Personal Zapping".

3 Teletext buttons (for certain models only)

Allows you to access teletext information. For detailed description of functions, refer to section on "Using the Teletext"

4 Smiley button

Allows to add and store your personal preference channels in your Personal Preference list. For detailed description of functions, refer to section on "Using your Personal Zapping feature".

5 Timer Button

Not applicable.

6 Smart Sound Button

Press the Smart Sound button repeatedly to access 4 different types of sound settings and choose your desired setting.

7 Menu Button

Displays the main menu. Also exits menu from screen.

8 Cursor Up Button

Allows you to select the next item on the menu.

9 Cursor Left Button

Allows you to select the sub-menus and adjust the settings.

10 Volume + / - Button

Increases or decreases volume.

11 I/II (for certain models only)

Allows you to switch from Stereo to Mono sound during stereo transmission or to choose between language I or language II during dual sound transmission.

12 A/CH (Alternate channel) Button

Allows you to change between the current channel and the previous channel.

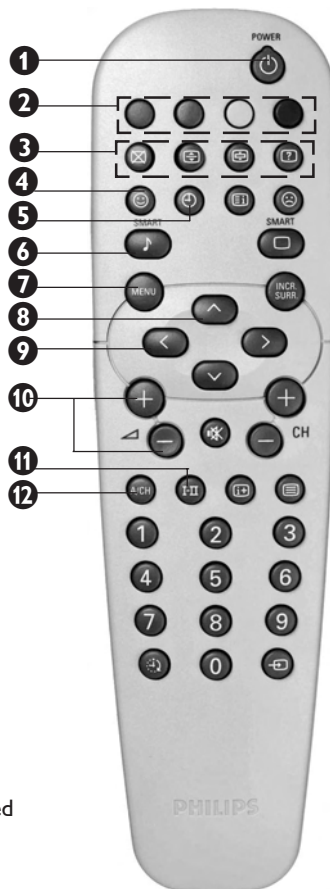









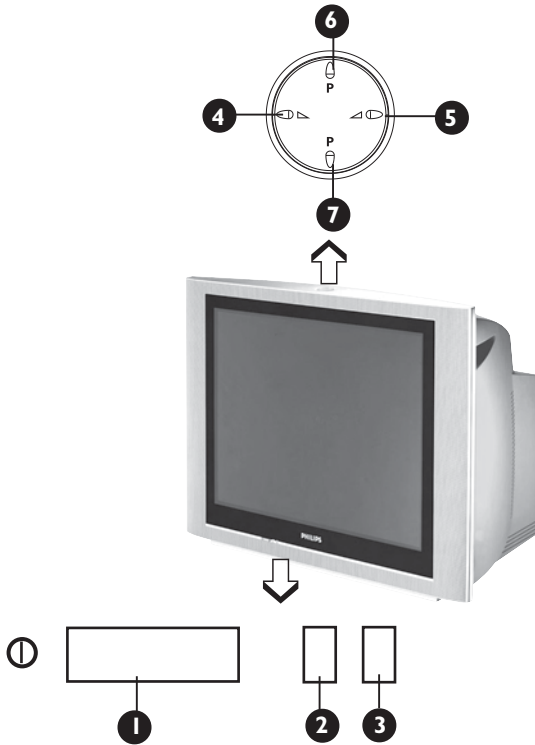

FUNCTIONS OF REMOTE CONTROL



- 13 Main Index Button (for certain models only)**
In teletext mode, press button to return to the main index page.
- 14 Frownie button**
Allows to delete stored personal preference channels in your Personal Preference list. For detailed description of functions, refer to section on “Personal Zapping”.
- 15 Smart Picture Button**
Press the Smart Picture button repeatedly to access 5 different types of picture settings and choose your desired setting.
- 16 Incredible Surround Button (for 21PT4223)**
- Allows you to select Incredible Surround sound when transmission is in stereo mode.
 - Allows you to select Spatial Sound when transmission is in mono mode.
- 17 Cursor Right Button**
Allows you to access the sub-menus and adjust the settings.
- 18 Cursor Down Button**
Allows you to select the next item on the menu.
- 19 Channel + / – Buttons**
Allows you to select channels in ascending or descending order.
- 20 Mute Button**
Mutes sound. To restore sound, press button again.
- 21 Teletext Button (for certain models only)**
Refer to section on “Using the Teletext”
- 22 OSD button**
Allows you to display the current channel number. It also allows to exit menu from the screen after control adjustments.
- 23 Digit (0 -9) Buttons**
Press to select a channel. For a 2-digit channel number, press the first digit and followed immediately by the second digit.
- 24 AV Button**
Allows you to select the AV channels.
- 25 Sleeptimer Button**
Allows you to select a time period after which the set will switch to standby mode automatically.

FUNCTIONS OF TV CONTROLS



①	Mains Power button	Switch mains power on or off.
②	Standby Light indicator	Indicate red light when standby mode is activated.
③	Remote Sensor	Acts as a sensor for activating the controls of the TV when remote control handset is aimed at it.
④	Volume  button	Adjust sound volume softer.
⑤	Volume  button	Adjust sound volume louder.
⑥	Programme  button	Select channel in ascending order.
⑦	Programme  button	Select channel in descending order. Note <ul style="list-style-type: none"> You can enter the main menu by pressing both the Volume  and  buttons at the same time. Press the Programme  or  button to select the next item on the menu. Press the Volume  or  button to access the sub-menus and adjust the settings.

SELECTING THE MENU LANGUAGE

Operating instructions generally explains the operation of the TV set using the buttons on the remote control unless otherwise stated. Please read the following instructions carefully and follow the steps as shown to familiarise yourself with the installations and all features available in your set.

Note: When there is no signal input to the TV, you may encounter instability of the on screen display. In this instance, please use the  button on your remote control to select an AV channel.

The **Language** feature allows you to set the TV's on-screen menu to be shown in your desired language.

Step

Press button

Result on screen

1



Enter main menu.

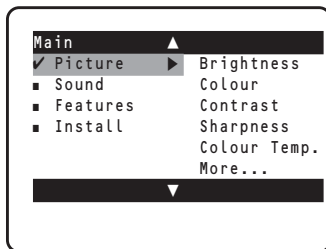

2



Select **Install**.

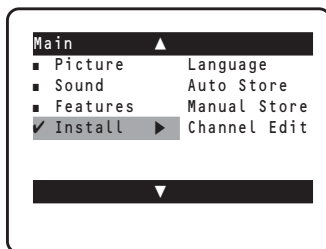

3



Enter the Install menu.

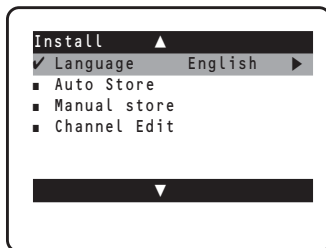

4



Press button repeatedly to cycle through the language list and select the language of your choice.









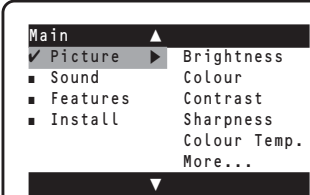

5

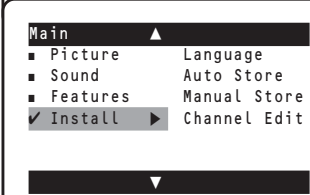

Exit menu from screen.

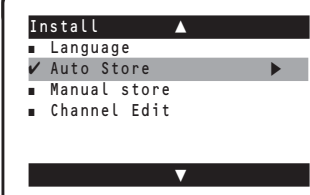
AUTOMATIC TUNING OF CHANNELS

Automatic tuning of channels allows you to store each programme automatically.

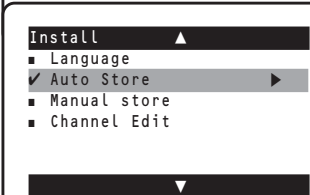
Step	Press button	Result on screen
1	 Enter main menu.	
2	 Press button repeatedly until Install is selected.	
3	 Enter install menu.	
4	 Select Auto Store .	
5	 Start automatic tuning of channels.	
6	 When tuning is completed, exit menu from screen.	

MANUAL TUNING OF CHANNELS

Manual tuning of channels allows you to select your preferred channel number for every available programme.

Step

Press button

Result on screen

1

MENU

Enter main menu.

```
Main ▲
✓ Picture ▶ Brightness
■ Sound      Colour
■ Features   Contrast
■ Install    Sharpness
              Colour Temp.
              More...
```

2



Press button repeatedly until **Install** is selected.

```
Main ▲
■ Picture    Language
■ Sound      Auto Store
■ Features   Manual Store
✓ Install ▶ Channel Edit
```

3



Enter install menu.

```
Install ▲
✓ Language ▶ English
■ Auto Store
■ Manual Store
■ Channel Edit
```

4



Press button repeatedly until **Manual Store** is selected.

```
Install ▲
■ Language   Colour System
■ Auto Store Sound System
✓ Manual Store ▶ Search
■ Channel Edit Channel
              Fine Tune
              Store
```

5



Enter manual store menu.









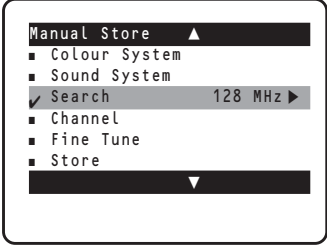

```
Manual Store ▲
■ Colour System
■ Sound System
✓ Search      79 MHz ▶
■ Channel
■ Fine Tune
■ Store
```

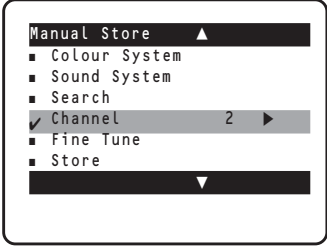
6

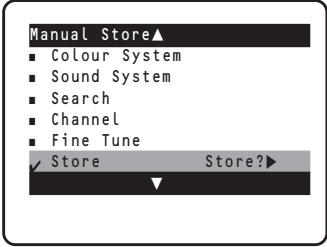

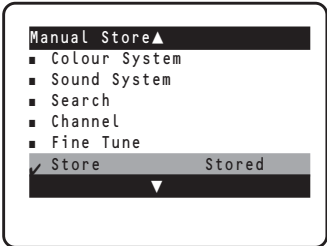
Press button repeatedly until **Search** is selected.

MANUAL TUNING OF CHANNELS

Step	Press button	Text	Result on screen
7		Start manual searching. Searching stops once a transmitting signal is found.	
8		Select Channel .	
9		Key in the channel number.	
10		Press button repeatedly until Store is selected.	
11		Store tuned channel. Note : If you want to continue searching for another transmitting channel, repeat steps 7 to 11.	
12		Exit menu from screen.	

SELECTING THE COLOUR/SOUND SYSTEM

This feature allows you to select your desired **Colour** and **Sound** system. If **Auto** is selected, the respective colour and sound system will be automatically selected according to the transmission system. **Note** : Select your desired colour and sound system manually if reception is poor at **Auto** mode.

Step

Press button

Result on screen

Repeat step 1 to step 5 as in “Manual Tuning of TV Channels”

Colour System is selected.

6

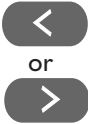

Select the desired colour system (**Auto**, **PAL**, **NTSC 3.58**, **NTSC 4.43** or **SECAM**).

7



Press button repeatedly until **STORE** is selected.

8



Store selected system.

9

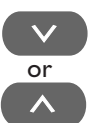

Proceed to select **Sound System**.

10

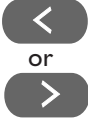

Select the desired sound system (**Auto**, **BG**, **I**, **DK** or **M**).

11



Press button repeatedly until **STORE** is selected.

12



Store selected system.

13





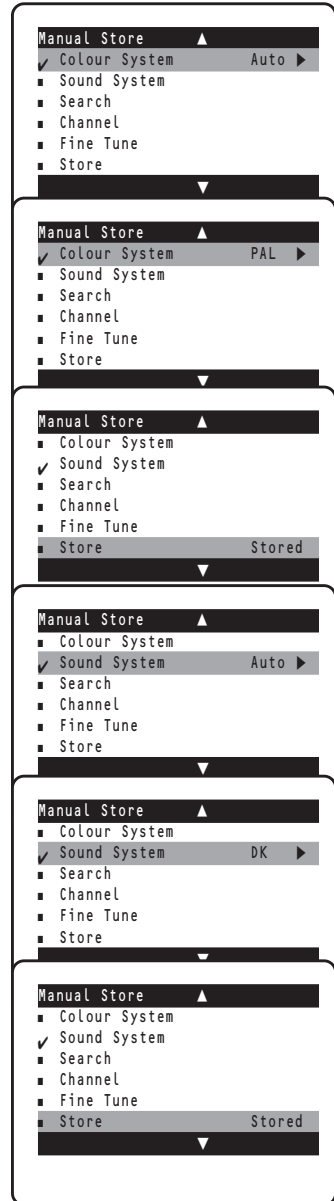





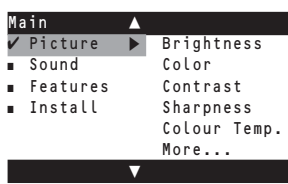

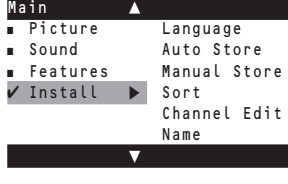

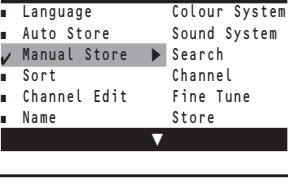

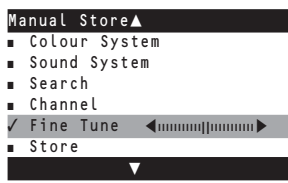

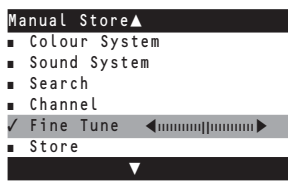

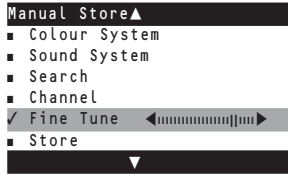
Exit menu from screen.

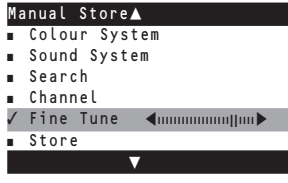

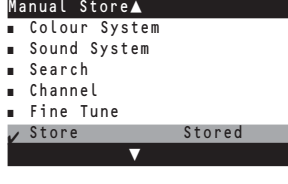

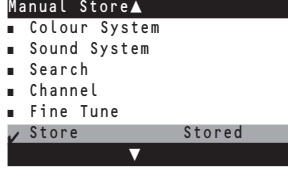

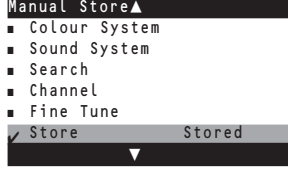





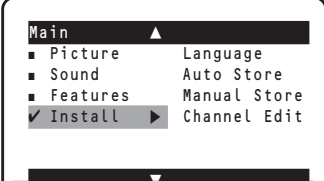

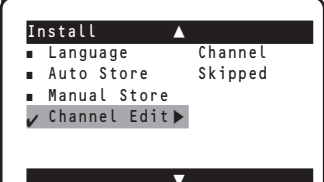
FINE TUNING OF CHANNELS

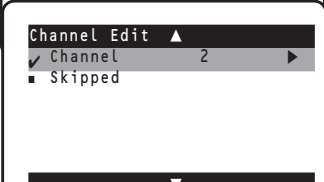
This feature allows you to adjust picture reception in areas of weak reception.

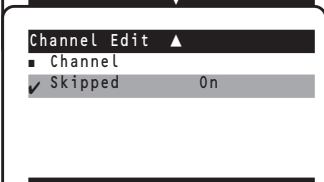

Step	Press button		Result on screen
1		Enter main menu.	
2		Press button repeatedly until Install is selected.	
3		Enter install menu.	
4		Press button repeatedly until Manual Store is selected.	
5		Enter manual store menu.	
6		Press button repeatedly until Fine Tune is selected.	
7	 or 	Fine tune until the best reception is obtained.	
8		Select Store .	
9		Store last fine-tuned status.	
10		Exit menu from screen.	

EDITING OF CHANNELS

This feature allows you to skip or edit channels which have bad or weak TV signal or channels that you do not watch often. **Note** : Once a channel is skipped, you cannot have access to it by the CH (Channel) + or – button. You can only have access to the channel by the Digit (0 -9) buttons.

Step	Press button	Result on screen
1	 Enter main menu.	
2	 Press button repeatedly until Install is selected.	
3	 Enter install menu.	
4	 Press button repeatedly until Channel Edit is selected.	
5	 Enter Channel Edit menu.	
6	 Key in the channel number to be skipped.	
7	 Select Skipped .	
8	 Select On to skip channel.	
9	 Exit menu from screen.	





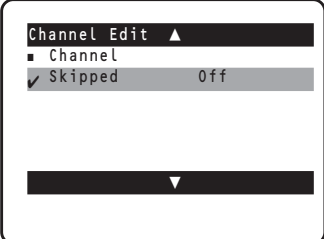

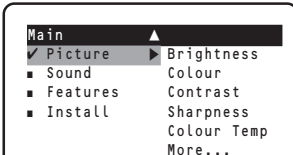

HOW TO RESTORE SKIPPED CHANNELS

- Repeat **Steps 1 to 5** as in "Editing of Channels".
- Key in the channel number to be restored by the **Digit (0 - 9)** button.
- Select **Skipped** by the  button.
- Select **Off** to restore channel by the  button.
- Exit menu from screen by the  button.

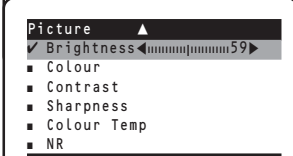

ADJUSTING THE TV PICTURE

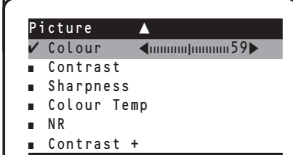







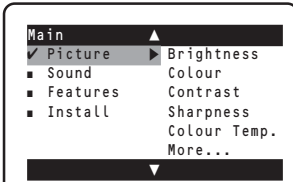

The picture menu allows you to make adjustments to the picture.

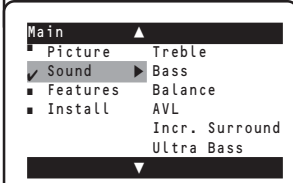
Step	Press button	Result on screen
1	 Display the main menu on screen.	
2	 Enter Picture menu.	
3	 or  Select item.	
4	 or  Adjust level or select desired setting.	
5	 Exit menu from screen.	

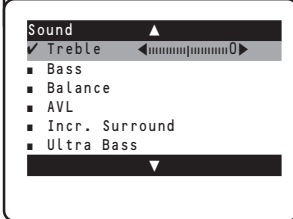
Picture menu items	Activities
Brightness	Increase or decrease brightness level.
Colour	Increase or decrease color level.
Contrast	Increase or decrease contrast level.
Sharpness	Increase or decrease sharpness level to improve detail in picture.
Colour temperature	Choose from 3 settings (Normal, Warm or Cool).
NR (Noise Reduction)	Select “ On ” to reduce “noisy” picture (little dots on picture) due to weak signal.
Contrast +	Select “ On ” to allow you to optimise the total contrast for improved picture quality.

ADJUSTING THE TV SOUND (FOR 21PT4223)









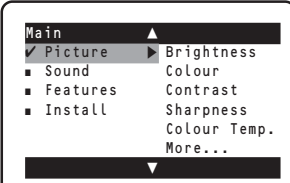

The sound menu allows you to make adjustments to the sound.

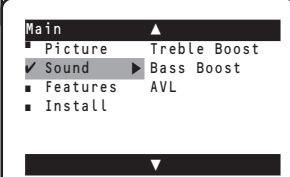
Step	Press button	Result on screen
1		
2		
3		
4	 or 	
5	 or 	
6		

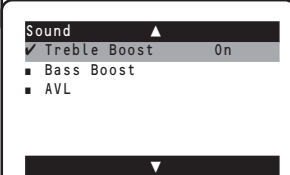
Sound menu items	Activities
Treble	Increase or decrease high frequency level.
Bass	Increase or decrease low frequency level.
Balance	Increase or decrease to adjust balance level.
AVL (Auto Volume Leveller)	Select On to enable volume to remain at a pre-determined level should there be a sudden change in volume during commercial breaks or channel switching.
Incredible Surround	Select On to boost the effect of stereo sound.
Ultra Bass	Select On to enjoy enhanced bass output.

ADJUSTING THE TV SOUND (FOR 21PT3323)







The sound menu allows you to make adjustments to the sound.

Step	Press button	Result on screen
1	 Display the main menu on screen.	
2	 Select Sound menu.	
3	 Enter Sound menu.	
4	 or  Select item.	
5	 or  Adjust level or select desired setting.	
6	 Exit menu from screen.	

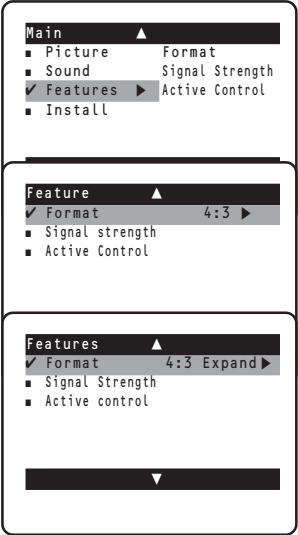
Sound menu items	Activities
Treble Boost	Switch on or off high frequency level.
Bass Boost	Switch on or off low frequency level.
AVL (Auto Volume Leveller)	Select On to enable volume to remain at a pre-determined level should there be a sudden change in volume during commercial breaks or channel switching.

USING THE SCREEN FORMAT

You can have a choice of two formats for your viewing pleasure, namely :- **4:3** mode and the **EXPAND 4:3** mode through the **FORMAT** menu.

Step	Press button		Result on screen
1		Display the main menu on screen.	
2		Press button repeatedly until Features is selected.	
3		Enter the Features menu.	
4		Press button repeatedly until Format is selected.	
5		Press the button repeatedly to cycle through the different formats (4:3 or Expand 4:3) or and select your desired format.	
6		Exit menu from screen.	

Note:Active Control will not be displayed on 21PT3323.

When to use the Screen Formats

4:3 format

Select the 4:3 format if you want to display the 4:3 picture using the full surface of the screen.

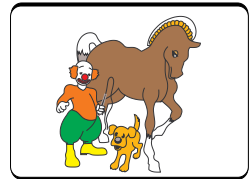

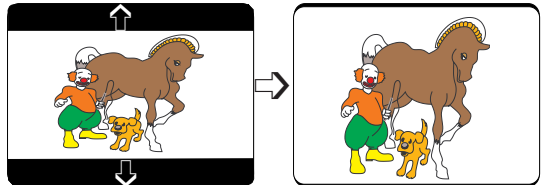

Expand 4:3 format

Select the Expand 4:3 format if you want to expand movie images recorded in the letterbox format. When this format is selected, the black horizontal bars at the top and bottom are expanded thus filling up the entire TV screen.



ACTIVATING THE SIGNAL STRENGTH

The Signal Strength feature displays the signal strength level when the **On** option is selected. The signal strength level will be indicated at the bottom of the screen whenever you switch channel.

Step	Press button	Result on screen
1		Display the main menu on screen.
2		Press button repeatedly until Signal Strength is selected.
3		Press the button to select On option to activate the Signal Strength mode.

Note (for 21PT4223): When signal strength is poor, you can proceed to the Active Control feature in the Feature menu and select **On** option to automatically adjust settings for optimal picture quality.
(Refer to section on “Using the Active Control”)

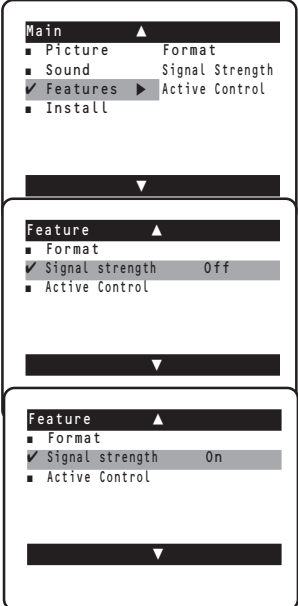





The screenshots show the following menu structure:

- Main** menu:
 - Picture
 - Sound
 - Features (selected)
 - Install
- Feature** menu:
 - Format
 - Signal strength (selected)
 - Active Control
- Feature** menu (Signal strength):
 - Format
 - Signal strength (selected) - Off
 - Active Control
- Feature** menu (Signal strength):
 - Format
 - Signal strength (selected) - On
 - Active Control

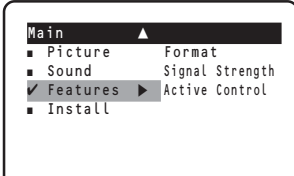
USING THE ACTIVE CONTROL (FOR 21PT4223)

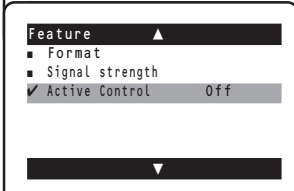
This feature automatically adjust settings for optimal picture quality continuously under any signal conditions. To activate the Active Control feature, select the “ON” option in the Active Control menu.

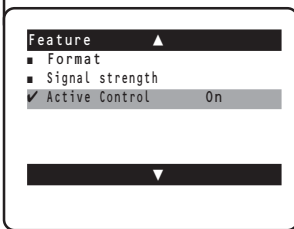
Step	Press button		Result on screen
1		Display the main menu on screen.	
2		Press button repeatedly until Features is selected.	
3		Enter the Features menu.	
4		Press button repeatedly until Active control is selected.	
5		Press the button to select On option to activate Active Control mode. If Display On option is selected, the settings of Brightness, Contrast, Sharpness, Contrast + and Noise Reduction will be displayed on the screen when the set is switched on or when you switch to another channel.	

SMART PICTURE CONTROL

Whether you are watching a movie or video game, your TV has automatic video control settings matched to your current program source or content. The Smart Picture feature quickly resets your TV's video controls of program for a number of different types of programs and viewing conditions you may have in your home. Each Smart Picture setting is preset at the factory to automatically adjust the TV's Brightness, Colour, Picture and Sharpness levels.

Step

Press button

1



Press button repeatedly to cycle through the 5 settings namely, **Personal**, **DVD/VCD**, **Rich**, **Natural** and **Soft** and select your desired picture setting.

2



Exit menu from screen.

Defintion of Picture Settings

Personal : Picture settings are set to your preference.

DVD/VCD : For optimal picture setting, whenever the source is connected to DVD/VCD player, select DVD/VCD setting for AV mode.

Rich : Emphasize very vibrant colours. This setting is the optimal setting when you are viewing TV programmes in a brightly-lit room.

Natural : Emphasize original colours.

Soft : Emphasize “warm” colours. (Suitable for dimly-lit room condition and gives cinema-like effect when light is switched off).

Personal

DVD/VCD

Rich

Natural

Soft

SMART SOUND CONTROL

Whether you are watching a movie or video game, your TV has automatic sound control settings matched to your current program source or content. The Smart Sound feature quickly resets your TV's sound controls of program for a number of different types of programs and viewing conditions you may have in your home. Each Smart Sound setting is preset at the factory to automatically adjust the TV's Treble and Bass levels.

Step

Press button



Press button repeatedly to cycle through the 4 settings namely, **Personal**, **Theatre**, **Music** and **Voice** and select your desired sound setting.



Exit menu from screen.

Definition of Sound Settings

Personal : Sound settings are set to your preference.

Theatre : Emphasize sensation to action.
(Bass and Treble boosted)

Music : Emphasize low tone (Bass boosted).



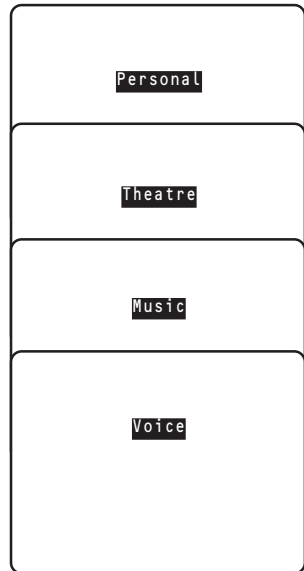





Voice : Emphasize high tone (treble boosted).





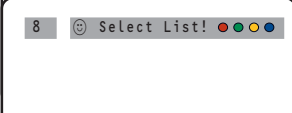

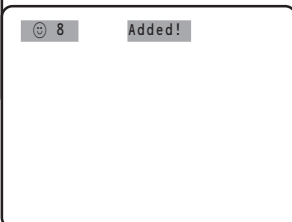
PERSONAL ZAPPING

A list or series of favourite TV programs can be selected and stored in the 4 coloured buttons with the Personal Zapping feature. With this feature you can easily view up to a total of 10 preferred channels for each coloured button.









Adding Channels to the Favourite list

Step	Press button		Result on screen
		Select a channel by the Digit buttons	
		Press button to display list.	
		Choose your favourite colour button to store selected channel. Repeat steps 1 to 3 to add and store your favourite channels to the list.	
		Exit menu from screen.	

To view through the favourite list

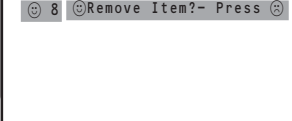
		Press the colour button that you have selected.
		Press button repeatedly to cycle through your favourite list and view your favourite channel.

Deleting Channels from the Favourite list

		Select a colour button and press button repeatedly to select the channel you want to delete.	
		Press button to display list.	
		Press button to remove item. Repeat steps 1 to 3 to delete more channels from list.	
		Exit menu from screen.	

USING THE TELETEXT (FOR CERTAIN MODELS ONLY)

If a TV channel broadcast contains teletext information, each channel that broadcasts teletext transmits a page (index page) with information on how to use the teletext system, usually on page 100. The system transmitted is indicated in the option line at the bottom of the screen.

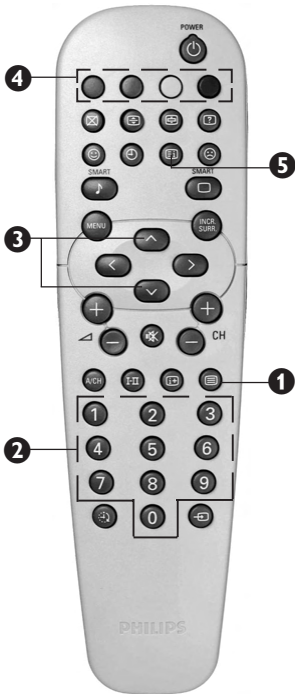

Press button

Result on screen

- 1 On/Off teletext and Superimpose teletext page over TV programme**

Press the button once to switch on teletext display. (A channel in which teletext is being transmitted must be selected). Press the button the second time superimpose the teletext page over the TV programme. Press the button the third time to exit teletext mode.





- 2 Selecting a teletext page**



Key in the required teletext page (3 digits). The page number is displayed at the top left hand corner of the screen. When the teletext page is located, the counter stops searching. If the counter keeps searching, it means that the page is not available for selection. If you make a mistake in keying the page number, you have to complete keying the 3-digit number before re-keying the correct page number.

- 3 Accessing a teletext page**



Press the  button to display the next page and the  button to display the previous page.

- 4 Direct Access to an item or corresponding pages**



The 4-colour buttons allow you to access directly an item or corresponding pages.

- 5 Main Index**



Press the button to return to the main index page.

USING THE TELETEXT (FOR CERTAIN MODELS ONLY)



Press button

Result on screen

6 Interrupt



Press the button to change to TV mode. Press the button again to return to teletext mode and to the teletext page.

7 Enlarge



Press the button once to enlarge and view the top half of the page. Press the button the second time to enlarge and view the bottom half of the page. Press the button the third time to return to normal size page.

8 Hold



A selected page sometimes contains a few sub-pages. The sub-page will automatically move to the next sub-page after about 20 seconds. The total number of sub-pages are indicated at the top right hand corner of the screen. Press the button once to hold page and the second time to release holding of page.

9 Reveal/Conceal



Press the button once to reveal hidden information (solutions to puzzles, riddles, etc). Press the button the second time to conceal information. This button is applicable only to teletext page with puzzles, riddles, etc.)

SPECIFICATIONS

	21PT3323	21PT4223
Picture tube screen size	550 mm	
Picture tube visible area	510 mm	
Audio Output : Speaker	2 x 5 W	
TV System	NTSC M PAL B/G PAL D/K PAL I SECAM B/G SECAM D/K SECAM K1	
Playback System	NTSC 3.58, NTSC 4.43, PAL 60 (tbc)	
Stereo system	AV Stereo	2CS BG NICAM DK NICAM BG NICAM I
Set Dimensions : Width Depth Height	600 mm 487 mm 454 mm	
Net Weight of Set (approximate)	25 kg	

Note

For Operating Voltage, Frequency, Power Consumption and Version Number, refer to the type number at the rear of the set.



3141 055 21361