

Panasonic

Widescreen
Stereo Colour Television
With TELETEXT
Operating Instructions

TX-86PW100A
TX-76PW100A
TX-76PW50A

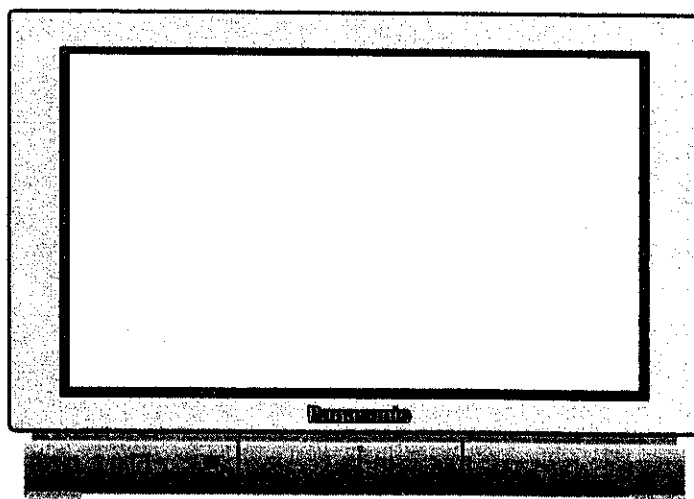

turn your life on

Please read these operating instructions completely before operating this set and retain the booklet for future reference.

Dolby, Pro Logic and the  symbol are trademarks of Dolby Laboratories.

Manufactured under licence from Dolby Laboratories.

Manufactured under licence from Digital Theatre Systems, Inc. US Pat. No. 5,451,942 and other worldwide patents issued and pending. "DTS" and "DTS Digital Surround" are trademarks of Digital Theatre Systems, Inc. Copyright 1996 Digital Theatre Systems, Inc. All Rights Reserved.

TQB4A0152

Dear Panasonic Customer,

Welcome to the Panasonic family. We hope that you will have many years of enjoyment from your new Colour Television.

Please retain your proof of purchase along with these operating instructions. Space has been made available on the back page of this instruction book for recording the Serial Number. The Serial Number can be found on the back cover of the set and on the packing carton.

Important Information

The picture tube has a special coating.

- Please only use a soft cloth when you clean the surface of the picture tube
- The film can be easily scratched.
- DO NOT rub the surface with a hard material.
- DO NOT use salt water, insecticide, chloric or acidic cleaning solvent or cleaning agent with abrasive materials.
- DO NOT heat the screen surface to 80°C or higher.

Programme Location Numbers

This television comes to you "factory tuned" to all the major capital city broadcast stations. Adjustments to the tuning should not be necessary. However, if you have to make adjustments, please read these instructions carefully first. Throughout this booklet "Programme Location Numbers" are referred to. *These are memory locations into which you can tune television broadcast stations.* Any television station can be tuned into any Programme Location Number.

Picture Quality

All televisions are affected by Magnetic Interference.

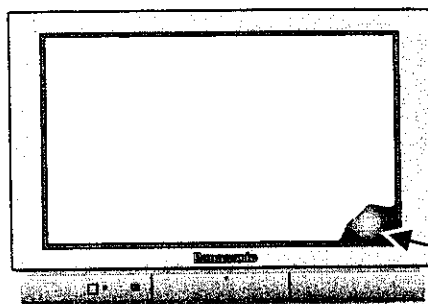

Magnetic interference may come from such things as unshielded motors, moving the TV while it is switched ON, turning off a vacuum cleaner too close to the TV, lightning strikes nearby or many other things. The interference shows up as *coloured patches* that appear while the TV is switched ON.

A typical result may look like the picture shown.

- Your Panasonic Television is designed to overcome this with the inclusion of a demagnetising (degaussing) function.
- To activate this feature, simply switch your Television OFF with the Power On/Off Switch (not with the remote control) for 30 minutes and then switch it back ON.
- If the television is to be left unattended for extended periods (several days or more), turn the power off to the unit. DO NOT leave in Standby mode.
- This will ensure that you enjoy the picture clarity as it was meant to be.
- Refer to page 32 for operating instructions for the GEOMAGNETIC feature.

Getting Started

Connect the Aerial

The RF (Aerial) Input impedance of this television is 75Ω. If your aerial lead is 300Ω ribbon (two wires separated by a flat plastic strip) you will require a 300Ω/75Ω Balun in order to connect your aerial to the television.

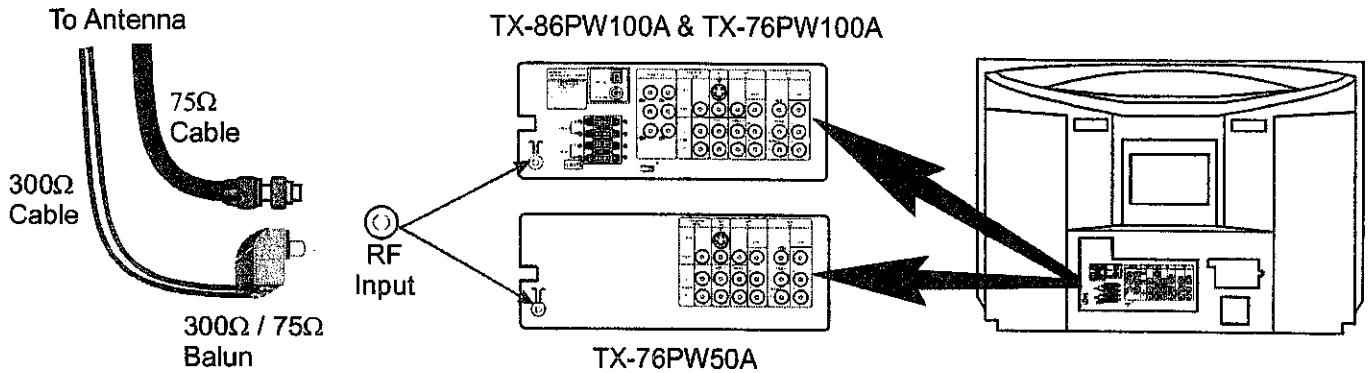

For your safety any external aerial should be installed by a reputable qualified installer and should comply with Australian Standard AS1417.1.

In New Zealand the installation should comply with International Standard IEC597-1.1.

Connect the Power Plug



This television is designed for the Australian Standard Mains Voltage of 240V 50Hz and the New Zealand Standard Mains Voltage of 230V 50Hz.

NOTE:







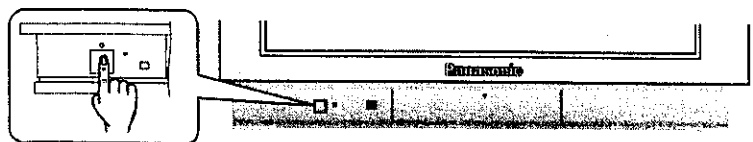





If the television is not going to be used for an extended period, remove the power plug from the wall outlet.

Turn on the Television



















Push the Power Switch to turn the television ON. Sit back and enjoy your new Panasonic television.



CONTENTS

Battery Installation and Replacement	6
Control Panel Buttons	7
Remote Control Buttons	7
STR.....	8
F.....	8
-/.....	8
+/\.....	8
TV/AV.....	8
 STANDBY.....	9
PICTURE.....	9
 SOUND.....	9
 SET UP.....	9
 STEREO / MONO / BILINGUAL*.....	9
100Hz / PROGRE.....	9
 SURROUND.....	9
 ASPECT.....	9
 MULTI PIP (TX-86PW100A & TX-76PW100A only).....	9
RECALL.....	10
N NORMALISATION.....	10
 STR.....	10
 HELP.....	10
 SOUND MUTE.....	11
 PROGRAMME NUMBER UP AND DOWN.....	11
 VOLUME DOWN AND UP.....	11
TV / AV.....	11
 COLOURED BUTTONS.....	11
STILL.....	11
CH SEARCH (TX-86PW100A & TX-76PW100A only).....	12
0 ~ 9 DIRECT PROGRAMME NUMBER SELECTION.....	12
- / - - TWO DIGIT PROGRAMME NUMBER SELECTION.....	12
Using the On Screen Displays	13
Picture Menu Operation	14 ~ 15
MENU.....	14
CONTRAST, BRIGHTNESS, COLOUR, SHARPNESS, NTSC-TINT.....	14
C. TEMP (Colour Temperature).....	15
P-NR (Picture Noise Reduction).....	15
AI (Artificial Intelligence).....	15
SCAN MODE.....	15
Sound Menu Operation	16 ~ 17
MENU.....	16
VOLUME, BASS, TREBLE, BALANCE, HEADPHONE VOL, SUBHEADPHONE.....	16
SUBWOOFER.....	17
DIGITAL AUDIO (TX-86PW100A & TX-76PW100A only).....	17
SURROUND MENU.....	17
Surround Sound Operation (TX-86PW100A & TX-76PW100A only)	18 ~ 20
Set Up Menu Operation	21 ~ 22
TELETEXT.....	21
OFF TIMER.....	21
FLICKER REDUCTION.....	21
STROBE.....	21
CH COLOUR SET.....	21
VCR / GAME.....	22
TEXT SELECT.....	22
CHILD LOCK.....	22
COLOUR SYS.....	22
TUNING MENU.....	22
GEOMAGNETIC.....	22
LANGUAGE.....	22

CONTENTS

Aspect Control	23
Teletext Operation	24 ~ 27
 F.P. (Favourite Page)	25
 SET UP	25
 TV/TEXT	25
 STR (Store)	25
 PAGE NUMBERS UP AND DOWN	25
 SUB-PAGE NUMBERS DOWN AND UP	25
 COLOURED BUTTONS	25
 INDEX	25
 HOLD	25
0 ~ 9 PAGE NUMBER BUTTONS	26
REVEAL	26
F/T/B (Full / Top / Bottom)	26
Display Cancel	26
TIME TEXT	26
Tuning Menu	27 ~ 31
SYS SELECT	27
AUTO TUNE	28
MANUAL TUNE	29
Tuning the Television to a VCR	29
FINE TUNE	30
SKIP	31
Geomagnetic Correction	32
Remote Control VCR/LD/DVD Operation	33 ~ 35
Remote Control VCR/LD/DVD Buttons	34
 REWIND / REVIEW	34
 STOP	34
 POWER BUTTON	34
 RECORD	34
 PAUSE	34
 PLAY	34
 FAST FORWARD / CUE	34
 VCR/LD/DVD	34
V \wedge PROGRAMME NUMBER DOWN AND UP / PROGRAMME SKIP	34
 STILL ADVANCE DISC SIDE B SELECTION	34
 DISC SIDE A SELECTION	34
Manufacturers' Code Settings	35
Connecting Equipment to the TV	36 ~ 42
Front Panel Connections	36
Connecting to the RGB Input Terminals	36
Adjusting the RGB Picture	37
AV Equipment	38
Headphones	38
Rear Panel Connections	39
Monitor Out	39
Connecting a Standard VCR to the AV Input	40
Connecting S-Video Equipment to the AV Input	40
Connecting DVD Equipment to the AV Input	40
Connecting the Audio Out Terminals (TX-86PW100A & TX-76PW100A only)	41
Connecting the Digital Audio Input (TX-86PW100A & TX-76PW100A only)	41
Connecting the External Speakers (TX-86PW100A & TX-76PW100A only)	42
Customer Information	43 ~ 48
Cleaning the Television	44
Cleaning the Remote Control	44
Frequently Asked Questions	45
Troubleshooting	46
Specifications	47
Customer's Record	Back Page

Battery Precautions

Open Battery Cover

Place your thumb on the battery cover triangle. Apply a slight downward pressure with the thumb and slide the cover back. This allows the cover to be removed.

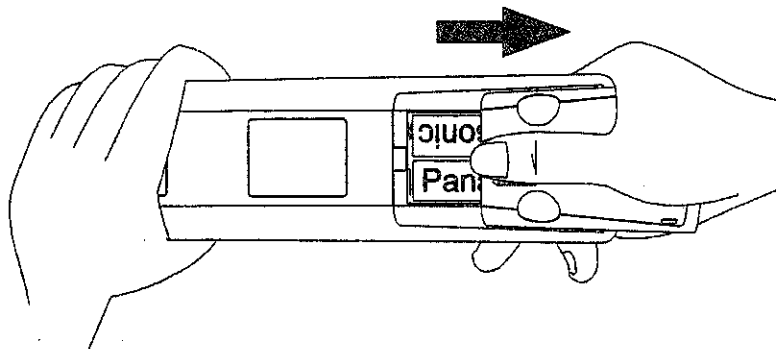

Insert Batteries

Insert the batteries ensuring the correct polarity. The polarity is identified by the "+" symbol on the battery and the "+" and "-" symbols on the battery compartment. The springs inside the battery compartment connect to the negative terminal of the battery.

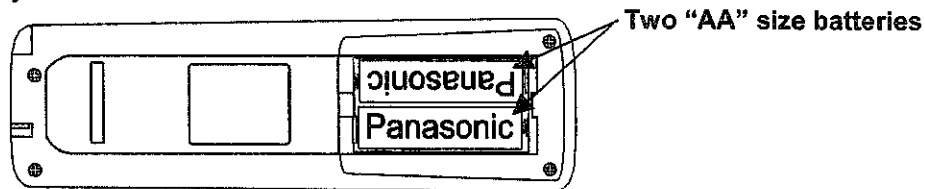

Replace Battery Cover

Fit the battery cover and slide it forward until it "clicks" into place.

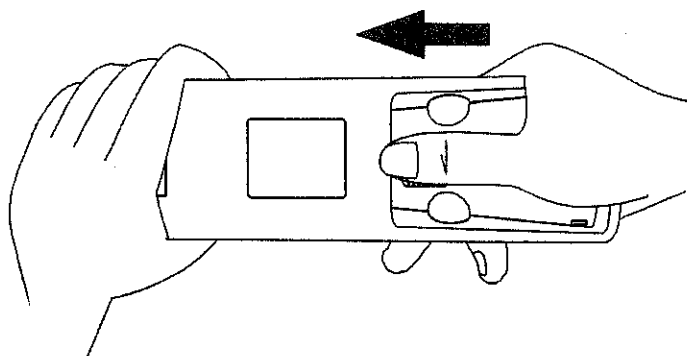

Battery Precautions

- Do Not use rechargeable batteries. Differences in size and performance may cause incorrect operation.
- Do Not mix battery types (Alkaline with zinc-carbon etc.)
- Do Not mix old and new batteries. Replace both batteries at the same time.
- Do Not attempt to recharge batteries.
- Do Not short circuit batteries.
- Do Not disassemble batteries.
- Do Not heat or burn batteries.

Control Panel Buttons

Open the control panel door to gain access to the Television Controls. Push the door at the point marked Δ to open. Push again to close.



- STR
- F
- -V
- +V
- TV/AV



Remote Control Buttons

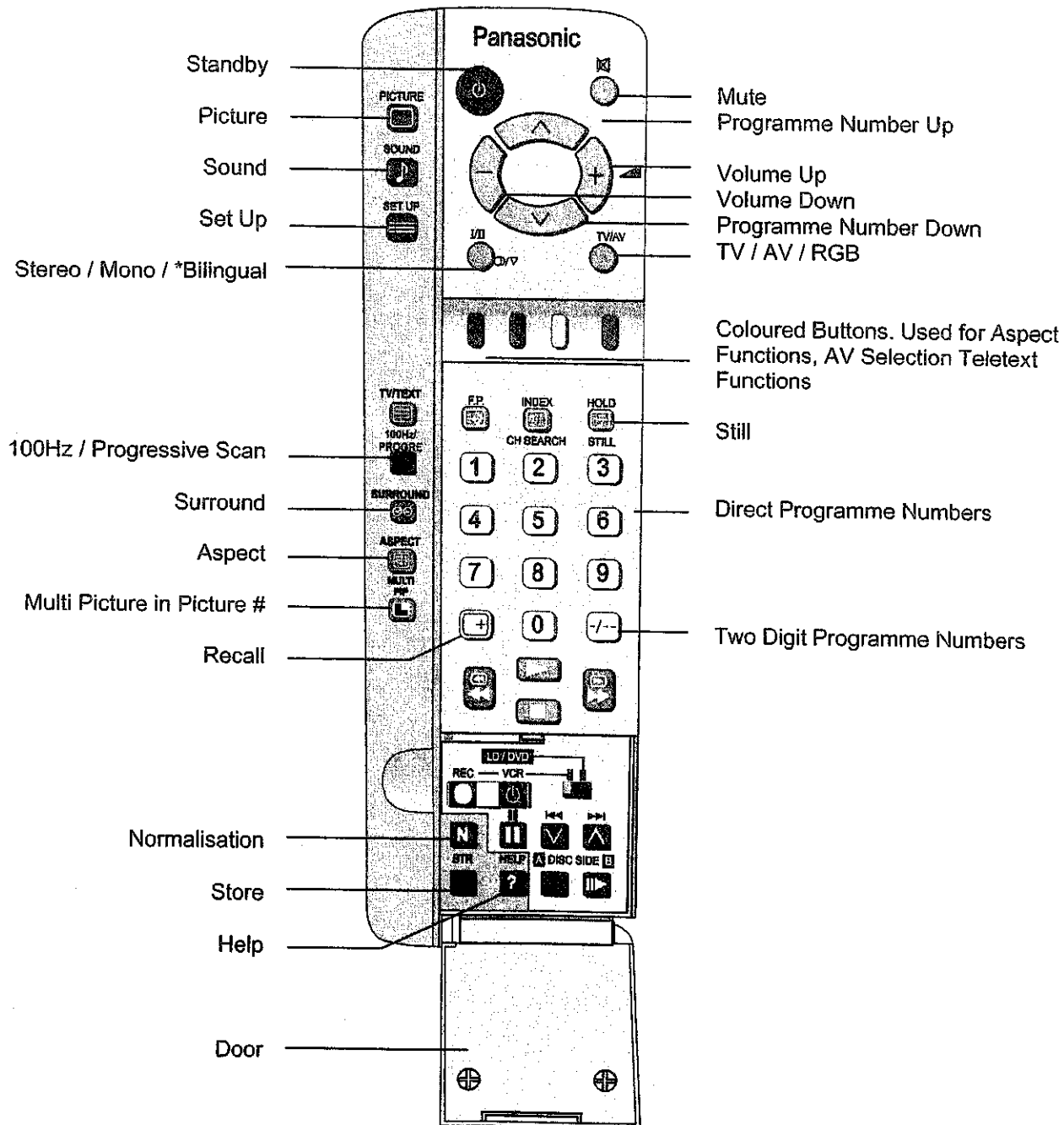

For details of TELETEXT Operation remote control operation, please refer to page 24.

For details of VCR, LD player and DVD player remote control operation, please refer to page 33.

* Bilingual broadcasting is not currently available in Australia or New Zealand.

"MULTI PIP" and "CH SEARCH" buttons have no effect on the TX-76PW50A.

Television Control Panel Buttons

BUTTON

WHAT IT DOES



STR

This button is used to store tuning information and other function settings. It is also used to start the menu demonstration.



F

The F button is used to select the on screen display functions. Press the button to select the following functions sequentially.

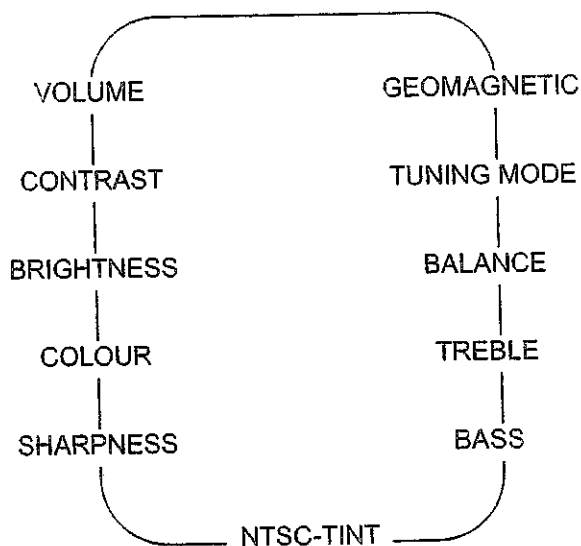

Notes:

- NTSC-TINT: Only displayed when receiving NTSC signals.
TUNING MODE: Not displayed when in AV mode.
BALANCE: Not displayed when SURROUND is on.



- / V

This button is used to select the next lower programme number. It is also used with the F button to adjust function settings.



+ / ^

This button is used to select the next higher programme number. It is also used with the F button to adjust function settings.



TV / AV

This button is used to switch between the TV mode, the four AV modes and the RGB mode.

Please refer to drawing on Page 7 for location of Remote Control Buttons.

Remote Control Television Operation

BUTTON

WHAT IT DOES



STANDBY

The remote control button is used to turn the television into Standby mode. When the television is in Stand-By it is possible to turn it back on by pressing this remote control Power Button, the Programme Number UP or DOWN Button (front panel or remote control) or any of the direct Programme Number Buttons.

PICTURE



PICTURE

This button is used to select the picture menu. Please refer to page 14 for detailed operating instructions.

SOUND



SOUND

This button is used to select the sound menu. Please refer to page 16 for detailed operating instructions.

SET UP





SET UP

This button is used to select the set up menu. Please refer to page 22 for detailed operating instructions.

I/I



STEREO / MONO

Pushing the button changes the mode from Stereo  to Mono  and back again. Normally the television will detect whether the broadcast signal is Mono or Stereo and will set the mode accordingly. If the Stereo signal is weak or if the receiving conditions are not the best, it is recommended that the Mono mode be manually selected.

BILINGUAL *

This system allows two languages to be transmitted for one broadcast. Switching between the Main (I) and (i) selects the desired language.

* Note: Bilingual sound is not currently available in Australia or New Zealand.

100Hz /
PROGRE



100Hz / PROGRE

This button allows you to change the Picture refresh setting between AUTO, 100Hz MODE and PROGRESSIVE. Please refer to SCAN MODE on page 15.

SURROUND



SURROUND

This button switches the SURROUND on and off.

ASPECT



ASPECT

This button is used to move through the different aspect options of AUTO, 4:3, ZOOM, S-ZOOM, 16:9, 14:9 and JUST. Please refer to page 23.

MULTI
PIP



MULTI PIP (TX-86PW100A & TX-76PW100A only)

Pressing this button will access the Picture in Picture options. If the 4:3 aspect ratio is selected you can choose between normal, Picture And Picture and Picture Out Of Picture. All other aspect ratio settings let you choose between normal, Picture And Picture and Picture In Picture.

Notes:

The MULTI PIP picture can be another television channel or an AV input.

While the On Screen Display is shown the sub-picture can be changed using the 0 ~ 9 and the "- / -" buttons, as shown on page 12.

When the On Screen Display disappears the main picture can be changed using the 0 ~ 9 and the "- / -" buttons, as shown on page 12.

MULTI PIP is not available on the TX-76PW50A.

Please refer to drawing on Page 7 for location of Remote Control Buttons.

Remote Control Television Operation

BUTTON

WHAT IT DOES

Picture In Picture Mode

Allows two pictures to be viewed at the same time. Pressing the Red button will change the position of the small picture. The Yellow button swaps between the two pictures. The Blue button removes the option bar.

This mode is not available in 4:3 mode.

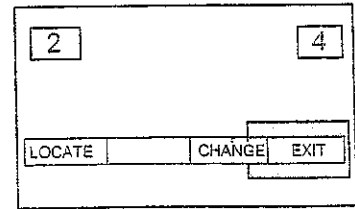

Picture Out Of Picture Mode (4:3 Mode only)

Allows two pictures to be viewed at the same time. The pictures will be shown side by side. The Yellow button swaps between the two pictures. The Blue button removes the option bar.

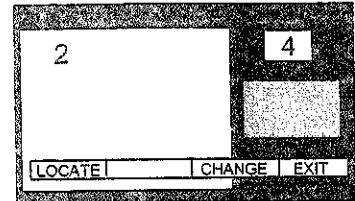

Picture And Picture Mode

Allows two pictures to be viewed at the same time. The pictures will be shown side by side. Both pictures will be the same size. The Yellow button swaps between the two pictures. The Blue button removes the option bar.

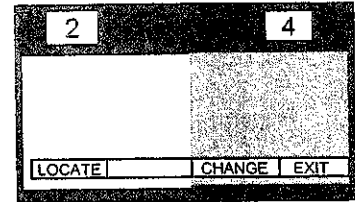

RECALL

Pressing this button will display all current active functions. The functions that can be displayed include AV Number, Programme Number, Sound Option, Picture Option, Stereo or Mono and Off-Timer setting. Pressing the button again cancels the recall function and removes the text being displayed on the screen. If the button is not pressed within about 2 seconds it automatically switches to display the Programme Number or the AV Number and the Off-Timer setting.

Pressing the button again cancels the recall function and removes the text being displayed on the screen.



NORMALISATION

The Normalisation Button is used to reset the television to factory set levels. Colour, Sharpness, Contrast, Brightness, Treble, Bass and Balance will be reset. The button will only operate if the menu is displayed on the screen.

STR



STR

The STR (Store) button is used with a number of features to store settings after adjustments have been made or options have been set. It is also used in TELETEXT and tuning functions.

HELP



HELP

Pressing this button displays on screen instructions on how to adjust various settings and how to connect external equipment. Press the HELP button and select one of the options. Please refer to page 13.

Please refer to drawing on Page 7 for location of Remote Control Buttons.

Remote Control Television Operation

BUTTON

WHAT IT DOES



SOUND MUTE

Pressing this button reduces the sound from the television to nil. Pressing the button again returns the sound to the original setting. Pressing the Volume Up (+) or Down (-) will also restore the volume level setting.

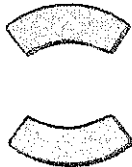

PROGRAMME NUMBER UP AND DOWN

Pressing this button selects the next higher (\wedge) or lower (\vee) Programme Number in sequence. Programme Numbers which have been "Skipped" (See page 31) will be bypassed when this button is used.



VOLUME DOWN AND UP

This button is used to increase (+) or decrease (-) the volume output level from the television.



TV / AV

Pressing the TV/AV Button will cycle between TV, the current AV Input, RGB and back to TV. While the AV indicator is still on screen the different AV inputs can be selected using the coloured buttons.

RED



AV1

GREEN



AV2

YELLOW



AV3 / RGB

BLUE



AV4



COLOURED BUTTONS

These buttons are used for:

- selecting different aspect ratios
- selecting different AV inputs
- teletext functions



STILL

Press this button to freeze the picture on the screen. Press it again to return to normal viewing.

If Multi Pip has been selected, pressing the Still button once will freeze the main picture while the sub picture remains normal. Pressing the Still button again will freeze the sub picture while the main picture returns to normal. Pressing the Still button for a third time will return both pictures to normal.

Please refer to drawing on Page 7 for location of Remote Control Buttons.

Remote Control Television Operation

BUTTON

WHAT IT DOES



CH SEARCH (TX-86PW100A & TX-76PW100A only)

This option is used to show freeze frames of the programmes being broadcast on all the stored channels. The images are displayed clockwise around the edge of the screen starting from the top left corner. The current programme is displayed in the centre of the screen. When the display gets back to the top left corner it will overwrite the first picture with the next one in series.

The display will continue to change until either the STILL button is pressed to pause or CH SEARCH is pressed to exit the feature.

The Red button is used to select each programme in turn. The green button is used to swap the main display between the current programme and the one selected by the red button. The Blue button returns to normal viewing.

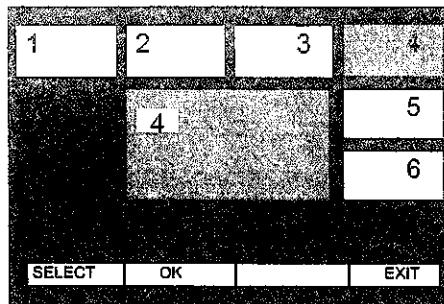

RED



SELECT

GREEN YELLOW



OK

BLUE



EXIT



DIRECT PROGRAMME NUMBER SELECTION

Single Digit Programme Numbers (0 to 9) can be accessed directly by pressing the corresponding number on the Remote Control Transmitter.



TWO DIGIT PROGRAMME NUMBER SELECTION

To directly access Programme Numbers 10 to 99, press the "- / -" Button followed by the two digits required. For example, to select Programme Number 12:



The On-Screen display will be as shown:

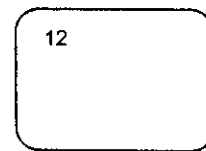
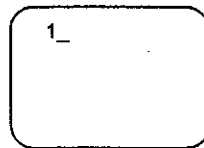
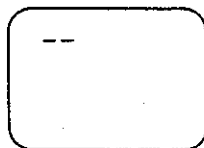

Please refer to drawing on Page 7 for location of Remote Control Buttons.

Using The On Screen Displays

Many features available on this TV can be accessed via the On Screen Display menu system. Use the remote control to access and adjust features as required.

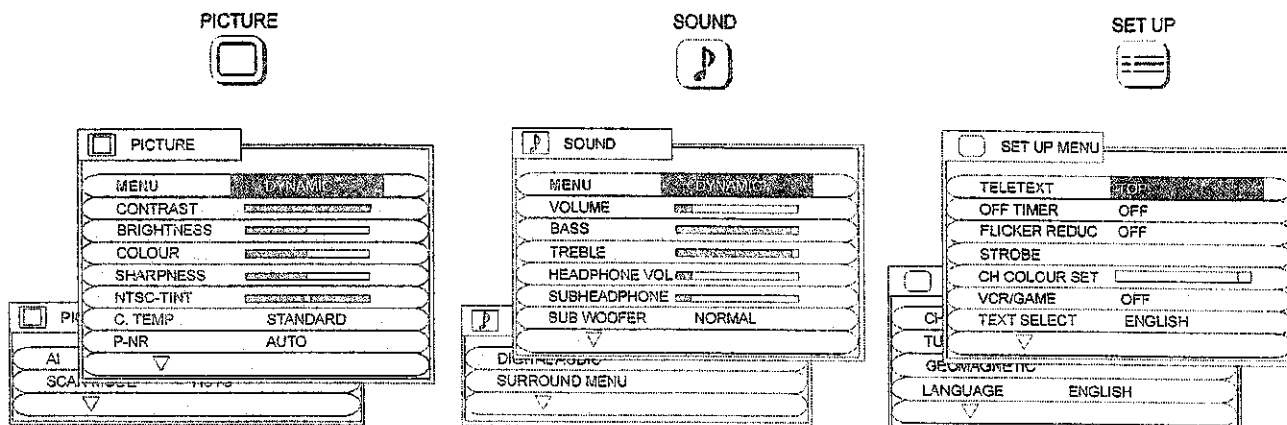

ON SCREEN HELP Instruction box

An on screen help box is displayed whenever a menu is displayed on the TV. This help box indicates which keys on the remote control are used to navigate the menu shown. See above for descriptions of button functions.

Note:

The help box is not shown in the menu pictures in this manual due to space limitations.

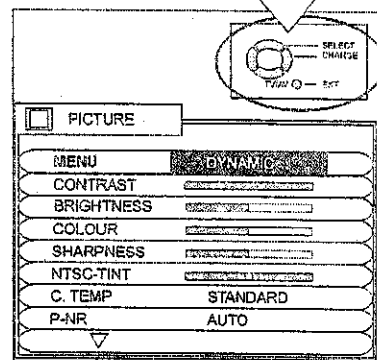

Pressing the HELP (?) button displays on screen instructions on how to adjust various settings and how to connect external equipment.

EXTERNAL CONNECTION

Press the UP or DOWN button to select the EXT. CONNECTION option. Use the LEFT or RIGHT button to view information on how to connect external equipment.





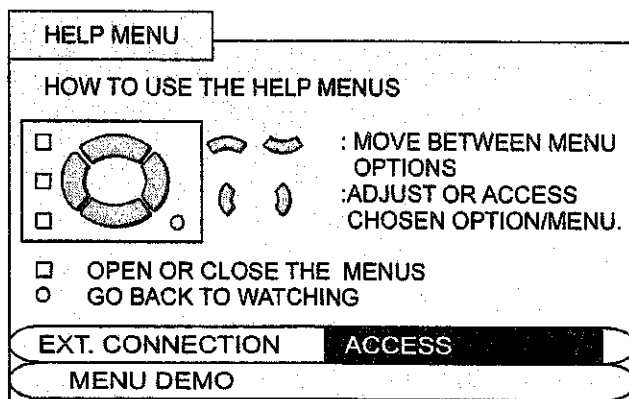

MENU DEMO

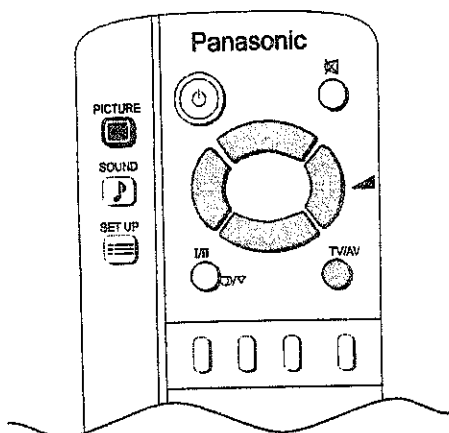
Press the UP or DOWN button to select the MENU DEMO option. Use the LEFT or RIGHT button to view the demonstration.





Picture Menu Operation



- 1 Push the PICTURE button. 
 - 2 Select the option menu using the   buttons.
 - 3 Adjust the chosen option using the   buttons.
- Push the TV/AV button  at any time to return to watching TV.

MENU

The MENU control allows you to change the Picture setting between Dynamic, Standard and Soft.

Use the   buttons to switch between settings.

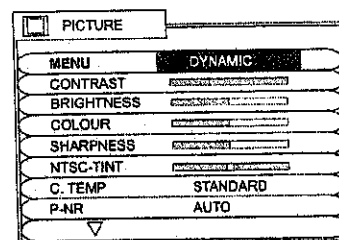









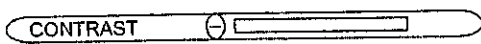

DYNAMIC

For viewing in brightly lit rooms. This menu selects higher than normal levels of Brightness and Contrast.

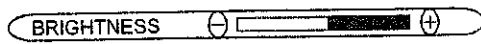
STANDARD For viewing in normal (evening lighting) environments. This menu selects the normal levels of Brightness and Contrast.

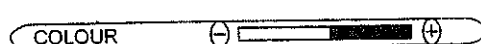
SOFT For viewing in a dark room. This menu selects reduced levels of Brightness and Contrast.

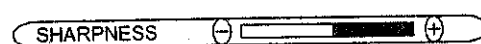
CONTRAST, BRIGHTNESS, COLOUR, SHARPNESS, NTSC-TINT

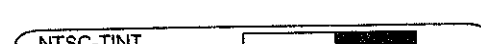
Item	Effect	Function	On-Screen Indication
CONTRAST	  Less More	Adjust for best picture contrast.	
BRIGHTNESS	  Darker Brighter	Adjust for easier viewing of dark pictures such as night scenes.	
COLOUR	  Less More	Adjust the level of colour in the picture.	
SHARPNESS	  Softer Sharper	Adjust to make the picture sharper or softer.	
NTSC-TINT	  Reddish Greenish	Adjust for best skin tones.	

Notes:

1. You can change the level for each function (Contrast, Brightness, Colour, Sharpness and NTSC-Tint) for each picture menu option.
2. Picture menu levels can be set for TV, AV1, AV2, AV3 and AV4 modes.
3. NTSC-TINT only appears when the TV is receiving NTSC signals.
4. Only CONTRAST will be displayed in TELETEXT mode.

Picture Menu Operation

C. TEMP

The C. TEMP (Colour Temperature) control allows you to change the White balance setting between Standard, Warm and Cool.

Use the or buttons to switch between settings.

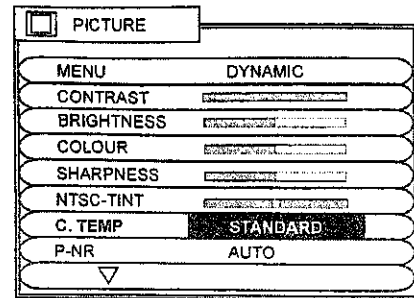

P-NR

The P-NR (Picture Noise Reduction) system is designed to reduce picture noise during poor quality reception conditions. Pushing the left or right buttons will change the setting between OFF, STRONG, WEAK and AUTO.

Use the or buttons to switch between settings.

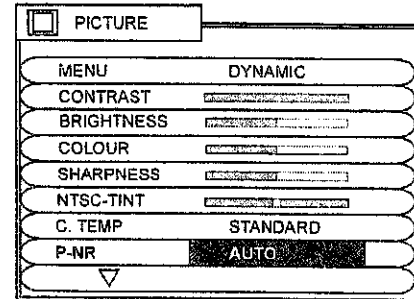

AI

When the AI (Artificial Intelligence) is turned on it continually and precisely detects fine differences in the picture signal. It also detects the differences in the brightness, black level and contrast levels.

Use the or buttons to switch the AI on or off.

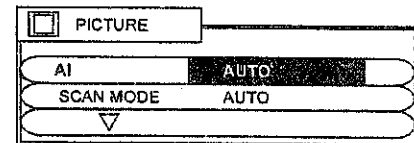

SCAN MODE

The SCAN MODE control allows you to change the Picture refresh setting between AUTO, 100Hz MODE and PROGRESSIVE.

Use the or buttons to switch between settings.

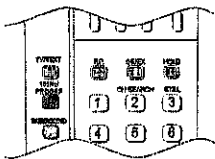
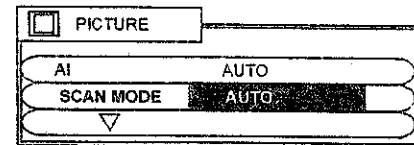

AUTO

The TV software will select the best mode for the signal being viewed.

100Hz MODE

100Hz will give a steady picture for most signals.

PROGRESSIVE

Recommended when receiving NTSC signals.

NOTE:

The scan mode function is not available when Picture in Picture is being used.

Switching is also possible using the button on the remote control.

Note:

We recommend that you set the SCAN MODE to PROGRESSIVE when viewing a PAL 60 or NTSC transmission. When viewing a PAL transmission (other than PAL 60) with the SCAN MODE set to PROGRESSIVE, the screen will flicker. This is not a fault.





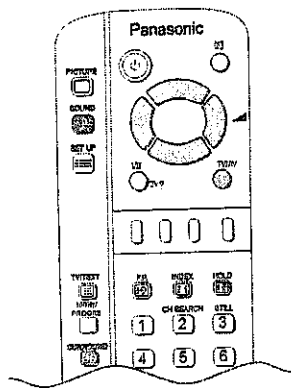

Normalisation

Pressing the Normal Button () on the remote control, when the Picture Menu is displayed will return all picture settings to the factory preset levels. This is called "Normalisation".

Normalisation *will not* occur if the Picture Menu is not displayed when the Normal Button is pressed.

Sound Menu Operation





- 1 Push the SOUND button .
 - 2 Move to the option menu using  or .
 - 3 Adjust the chosen option using  or .
- Push  at any time to return to watching TV.

Some features are only available with the SURROUND feature switched off.

Push the  button to switch the SURROUND on or off.













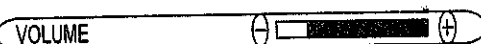



MENU

The MENU control allows you to change the Sound setting between Dynamic, Standard and Soft.

Use the  or  buttons to switch between settings.

- DYNAMIC** Amplifies the low frequencies and outputs optimum sound. Used for music programmes.
- STANDARD** For normal use.
- SOFT** Human voices (middle pitch sounds) will be clearer. Used for News broadcasts etc.

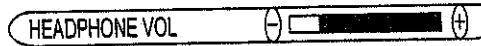
VOLUME, BASS, TREBLE, BALANCE, HEADPHONE VOL, SUB HEADPHONE.

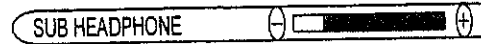
Item	Effect	Function	On-Screen Indication
VOLUME	  Quieter Louder	Adjusts the output volume.	
BASS	  Cut Boost	Used to boost or cut low frequency sounds.	
TREBLE	  Cut Boost	Used to boost or cut high frequency sounds.	
BALANCE	  Left SP Right SP	Adjusts the sound balance between the left and right speakers.	
HEADPHONE VOL	  Quieter Louder	Adjust for output volume for the headphones.	
SUB HEADPHONE (Not on TX-76PW50A)	  Quieter Louder	Adjust for output volume for the sub-picture headphones.	



Notes:

1. You can change the level for each function (Bass and Treble) for each sound menu option.
2. Sound menu levels can be set for TV, AV1, AV2, AV3 and AV4 modes.
3. BALANCE is not displayed when SURROUND is on.

Sound Menu Operation

SUBWOOFER

This function allows you to switch the SUBWOOFER between OFF, NORMAL and FULL modes.

Use the  or  buttons to switch between settings.

- OFF Turns the SUBWOOFER off.
- NORMAL Provides a mid-level bass effect.
- FULL Provides enhanced bass effect.

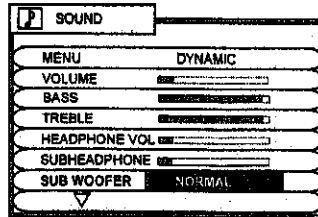

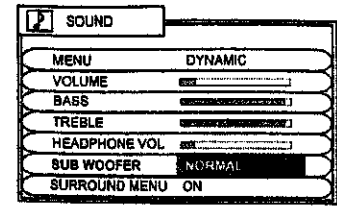

TX-86PW100A & TX-76PW100A



TX-76PW50A

DIGITAL AUDIO (TX-86PW100A & TX-76PW100A only)

Use the  or  buttons to switch the digital audio input between the different AV inputs. (AV1, AV2, AV3 and AV4).



If you do not have a digital audio input, set the option to OFF.

If you have a digital audio input from external equipment such as a DVD player switch the digital audio to the corresponding AV input. For example if the DVD is connected to AV2, set the digital audio to AV2.

SURROUND MENU

This function allows you to select the Surround options (TX-86PW100A & TX-76PW100A) or switch the Surround Sound on or off (TX-76PW50A).

Use the  or  buttons to switch between settings.

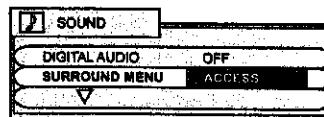

TX-86PW100A & TX-76PW100A

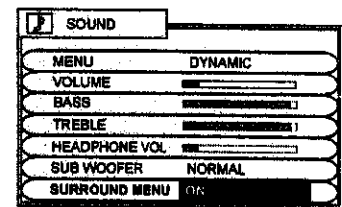

TX-76PW50A

Normalisation

Pressing the Normal Button () on the remote control, when the Sound Menu is displayed will return all sound settings to the factory preset levels. This is called "Normalisation".

Normalisation *will not* occur if the Sound Menu is not displayed when the Normal Button is pressed.

Surround Sound Operation (TX-86PW100A & TX-76PW100A)

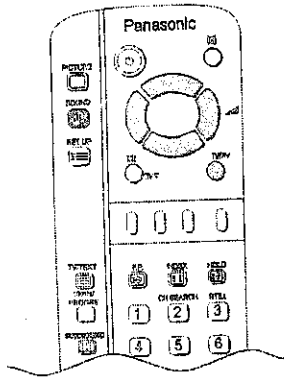

Push the Surround () to confirm that the Surround feature is On. If the on screen message that appears indicates Surround is Off, Push again to turn the feature On.

Note: If Surround is Off, the sound output is two channel (ie: left and right) stereo or mono.

- 1 Push the SOUND () button.
- 2 Select to Surround menu by using or .
- 3 Access Surround menu by using (or) .
- 4 Move to chose menu option by using or .
- 5 Adjust chosen option or access chosen menu by using (or) .

Push to go back to watching TV.

If a DTS / Dolby Digital input is detected the Surround menu options instantly change - Surround mode is not available. (The DVD output must be labeled "DTS" or "Dolby Digital"). Ensure that the Digital Audio option in the SOUND menu is set to the correct AV input (see pages 17 and 40). A message displayed in the centre of the screen shows whether the signal is DTS or Dolby Digital, and gives a code indicating which channels are detected (see table to the right). Subwoofer output is not listed; if a subwoofer channels is detected then its contents are output.

Code	Front outputs			Rear surround outputs	
	Left	Right	Centre	Left	Right
1+1	Dual mono output				
1/0	Mono output				
2/0	✓	✓			
3/0	✓	✓	✓		
2/1	✓	✓		Mono output	
3/1	✓	✓	✓	Mono output	
2/2	✓	✓		✓	✓
3/2	✓	✓	✓	✓	✓

VOLUME The volume adjustment sets the overall Surround output volume.

SURROUND MODE When a DTS/ Dolby Digital input is not detected this option is shown. Choose between PRO LOGIC and SIMULATED. The mode chosen here dictates the next menu option.

SPEAKER SETTING/ SIMULATED If a DTS / Dolby Digital input is detected, or if Pro Logic is selected in Surround mode, this menu option is Speaker setting, allowing selection of NORMAL, PHANTOM or 3 STEREO modes, as described on page 20.

If Simulated is selected in Surround mode, this menu option is Simulated setting, allowing selection of DISCO, MOVIE or STADIUM modes, as described on page 20.

SPEAKER LEVEL Allows adjustment of the volume for each speaker, as described on page 20.

FRONT DISTANCE Allows setting of the distance from the listening position to the front speakers. Distances of 1, 2, 3, 4, 5, 6, 7 or 8M can be selected.

REAR DISTANCE Allows setting of the distance from the listening position to the rear speakers. If the rear surround speakers are closer to you than the centre speaker, you may hear "dialogue leakage" from the rear surround speakers. It may be necessary to reduce the volume of the rear speakers. Distances of 1, 2, 3, 4, 5, 6, 7 or 8M can be selected.

INTERNAL SPEAKER If you do not have an external centre speaker connected, set to On. If you wish to connect an external centre speaker then switch Off, see page 42 for connection details.

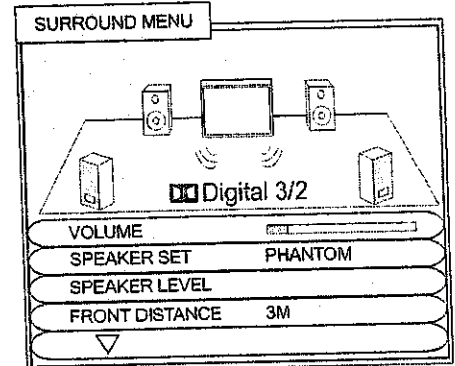

If a DTS / Dolby Digital Input is detected, the Surround menu is as shown above. This does not occur if the DVD output is PCM.

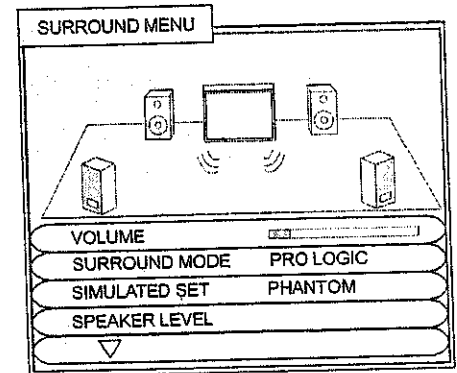

If no DTS / Dolby Digital input is detected, Surround mode appears as a menu option.

Surround Sound Operation (TX-86PW100A & TX-76PW100A)

Surround Sound Systems

Stereo reproduction normally uses left and right speakers, but Digital Theater System and Pro Logic Surround go further, adding a centre and other channels so you are immersed in sound and special effects.

Digital Theater Systems (DTS) / Dolby Digital

Both DTS and Dolby Digital split soundtrack information into 6 separate channels of sound which are output through the speaker setup: five full range channels (left, center, right, left surround, right surround) and a '0.1' (i.e.: limited range) bass channel. This gives you superb sound quality from DTS / Dolby Digital encoded tracks when a compatible speaker system is connected to your TV. Most dialogue comes from the centre channel, which enhances dialogue and focuses it so it seems to come from the action on screen. The separate rear left and right channels give a dramatic sense of space, with sounds travelling in all directions between front, centre and rear channel speakers (e.g.: a rocket going overhead starts behind you to the left and explodes in front of you to the right). The '0.1' Low Frequency Effects (LFE) channel gives impact to bass sounds and to special effects more felt than heard (e.g.: the thud of a dinosaur footfall or the rumble of thunder). While DTS and Dolby Digital are both high quality, '5.1' channel surround systems, the two systems differ in how they break down and store sound information. They also differ in how they work with existing speaker setups. Dolby Digital has been designed to be backwardly compatible with Dolby Pro Logic and conventional stereo setups. DTS on the other hand, focuses on the high quality, 5.1 channel surround output choosing not to develop backward compatibility with existing sound systems.

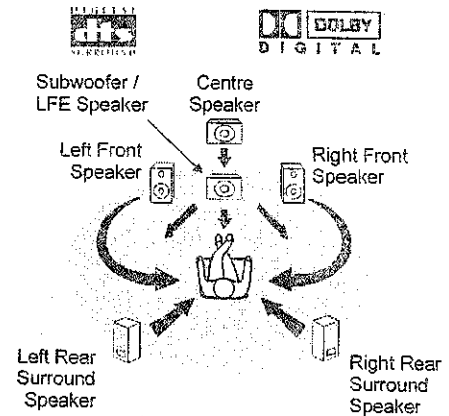

DTS/Dolby Digital setup

Note:

External equipment is usually connected to the TV via one of the AV terminals to provide pictures and sound (e.g. a VCR player connected to AV2). To receive a DTS or Dolby Digital encoded soundtrack from compatible equipment (e.g.: a DVD player, a set top box) you will also need to connect an optical or coaxial cable to one of the TV's digital audio sockets. See page 41 for connection details. Also see the Digital Audio option in the SOUND menu, page 17.

Dolby Pro Logic

Dolby Pro Logic surround uses four channels of sound: left, right, centre and a rear channel giving excellent reproduction of Pro Logic encoded tracks when a compatible speaker system is connected to your TV. Most dialogue comes from the centre channel, which enhances dialogue and focuses it so it seems to come from the action on screen. The rear channel is used to immerse you in atmosphere and special effects, the same output is sent to both rear speakers.

As with Dolby Digital, Pro Logic is backwardly compatible with a conventional stereo speaker setup.

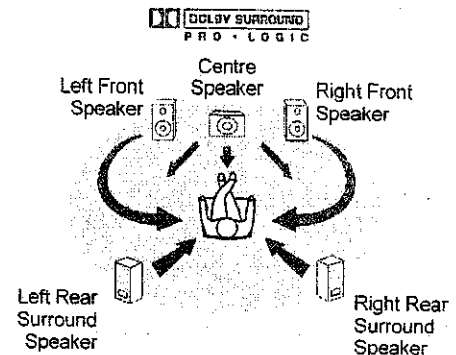

DTS/Dolby Digital setup

Note:

To get Pro Logic information from Pro Logic encoded TV programmes; you must be able to receive stereo transmissions. If stereo transmissions are not transmitted in your area then the Pro Logic information will not be present on TV transmissions and Pro Logic decoding will only produce a centre channel output.

Surround Sound Operation (TX-86PW100A & TX-76PW100A)

Dolby Digital and Pro Logic modes

For Dolby Digital input or Pro Logic selected in Surround mode, the following three modes of operation are available as the speaker setting: Normal, Phantom, and 3 Stereo.

Normal If front and rear speakers are connected, use Normal mode. The TV's internal left and right speakers will produce centre speaker information. With a DTS/ Dolby Digital 5.1 input, the TV's internal subwoofer produces the LFE speaker information. If the internal speaker is switched off (see page 18) and an external centre speaker used, the speaker must be connected using RCA cables, via an external amplifier (otherwise it will not output any sound). See page 41 for connection details.

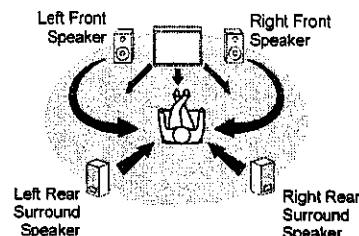

Phantom If front left and right speakers are not connected, use Phantom mode. Left, right, and centre information will now be produced by the TV speakers. If you choose to use this mode with the internal speaker switched off and front left and right speakers connected, these must be connected using RCA cables, via an external amplifier (otherwise they will not output any sound). See page 41 for connection details.

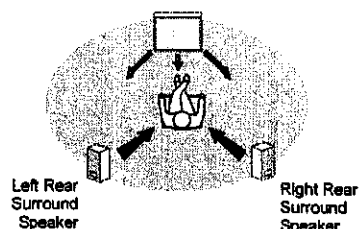

3 Stereo This is the best mode to use if rear speakers are not connected. When using this mode, the surround information is redirected to the front left and right speakers. The TV's internal speakers output centre information. If the internal speaker is switched off (see page 18) and an external centre speaker used, it must be connected to the TV using RCA cables, via an external amplifier (otherwise it will not output any sound). See page 41 for connection details.

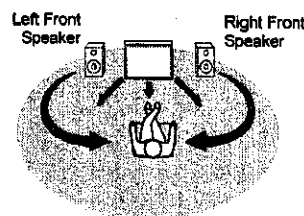

Simulated Mode

Simulated modes allow various types of surround effects to be produced by mimicking both the direct sound, as heard by the audience, and the sound reflected back from the surrounding walls, ceiling and floor in places such as a discos, stadiums etc. There are three different effects to choose from, each reflecting a different atmosphere:

Setting	Appropriate sources	Effect
DISCO	Disco, dance or jazz music	A crowded nightclub
MOVIE	All movies or music software recorded without Dolby Surround	Simulates a surround sound recording
STADIUM	Any live sports occasion	A packed sports stadium

Speaker Level Setup

The speaker output levels from the different options, e.g.: Left, Centre, Right, Rear right and Rear left, should be adjusted from your usual listening position, to obtain the best results. The level can be set using either the TV sound or the test signal provided. Pushing the SURROUND button switches between the test signal and TV sound.

Notes:

The adjustment menu available will vary according to the mode chosen. If you have a DTS / Dolby Digital 5.1 input, and are using the internal subwoofer to produce the LFE information, you can change the LFE volume by altering the Subwoofer setting in the SOUND menu. (see page 17).

When using external stereo equipment it is advisable to set the speaker levels to the midpoint position.

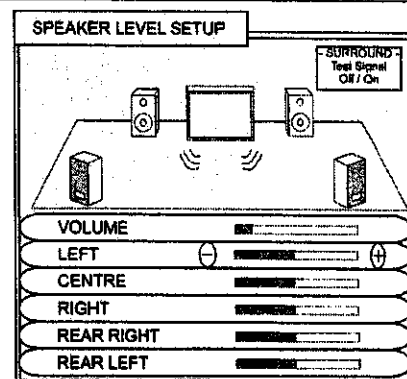

Set Up Menu Operation

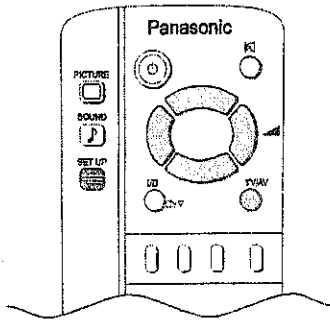

- 1 Push the SET UP button .
 - 2 Move to the option menu using or .
 - 3 Adjust the chosen option using or .
- Push at any time to return to watching TV.

TELETEXT

This control allows you to change between LIST and TOP or FASTEXT modes.

Use the or buttons to switch between settings.

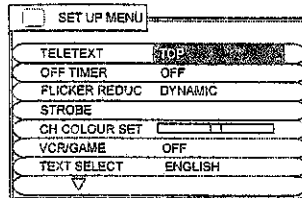

AUSTRALIA

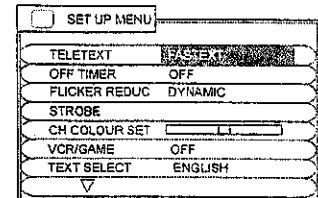

NEW ZEALAND

TOP mode is the current preferred method in Australia.
FASTEXT mode is the current preferred method in New Zealand.

OFF TIMER

The Off-Timer turns the television off after a period of time chosen by you. The timer settings (in minutes) are OFF, 15, 30, 45, 60, 75, 90.

Use the or buttons to switch between settings.

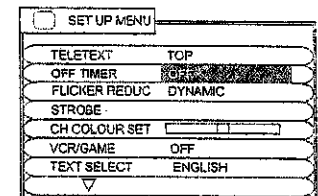

FLICKER REDUCTION

This lets you control any unwanted picture movement. The settings are OFF, NORMAL and DYNAMIC.

Use the or buttons to switch between settings.

- OFF No flicker reduction is applied.
- NORMAL Used to correct picture movement or if slight ghosting occurs when using DYNAMIC.
- DYNAMIC Activates motion compensation to smooth the image and gets rid of picture movement.

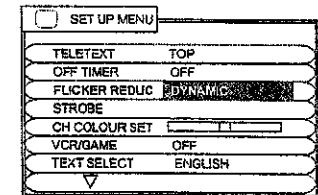

COLOUR SYS

COLOUR SYS is only available in AV mode. This option allows you to select the correct colour system for the signal being received. If a clear picture with correct colours cannot be obtained, a change to the Colour System may improve the picture. The settings are AUTO, PAL, NTSC4.43 and NTSC3.58. The Australian and New Zealand colour system is PAL.

Use the or buttons to switch between settings.

Note: PAL and NTSC3.58 are different colour signal broadcast transmission systems applicable to differing countries. NTSC4.43 is a system used in special VCRs to playback NTSC recorded tapes on a PAL television.

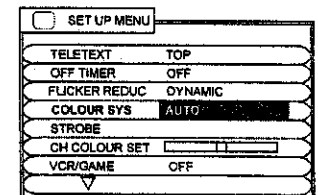

Set Up Menu Operation

STROBE

Lets you take a series of freeze-frame photos of a piece of action such as the finish or a race etc. The main picture is in the centre and smaller freeze-frame pictures appear around the outside.

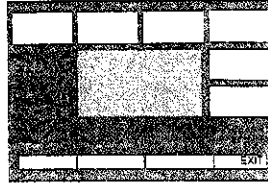

Use the (left) or (right) buttons to switch STROBE on or off.

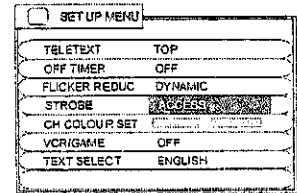

CH COLOUR SET

Colour density varying between broadcast channels can be adjusted to three levels for each channel received.

Use the (left) or (right) buttons to switch between settings.

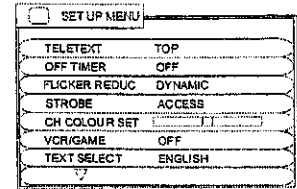

VCR/GAME

Reproduction of irregular signals such as certain video games or some rental videotapes may be improved by turning the VCR/GAME feature On.

Use the (left) or (right) buttons to switch VCR/GAME on or off.

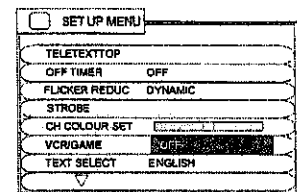

TEXT SELECT

Select the character set so that all characters needed are available for text on teletext pages. The languages available are ENGLISH, CIS and E.EUROPE.

Use the (left) or (right) buttons to switch between languages.

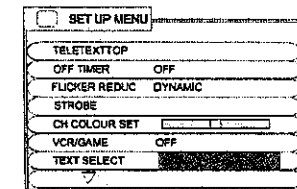

CHILD LOCK

CHILD LOCK allows you to "lock out" a channel to prevent a child from watching or hearing a particular programme. Select the channel or AV to be locked before pressing the SET UP button.

Use the (left) or (right) buttons to switch the CHILD LOCK on or off.

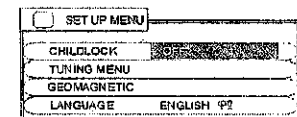

TUNING MENU

This provides access to many other features including system select and tuning options.

Use the (left) or (right) buttons to access the TUNING MENU.

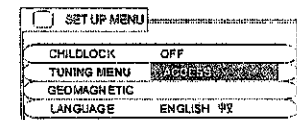

GEOMAGNETIC

If you notice a slight tilt in the picture or if there are coloured patches at the corners of the screen, use this feature to eliminate them. Refer to page 32.

Use the (left) or (right) buttons to access the GEOMAGNETIC Adjustment Menu.

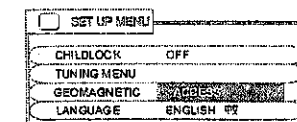

LANGUAGE

When you first install the TV the On Screen Display language is set to English. The language can also be set to Chinese.

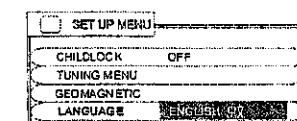

Use the (left) or (right) buttons to switch between languages.

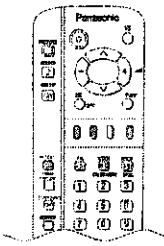

Aspect Controls

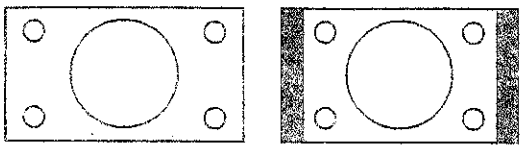
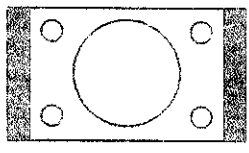

Press the ASPECT button  to select the different Aspect options. The options available are AUTO, 4:3, ZOOM, S-ZOOM, 16:9, 14:9 and JUST.

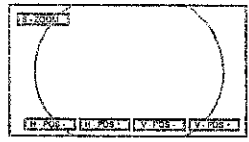
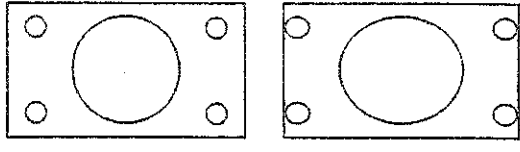
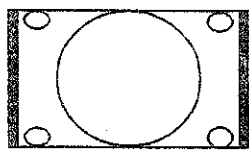
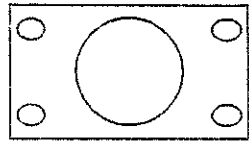
Mode	Picture	Description
AUTO	 <p>16:9 Signal 4:3 Signal</p>	The AUTO position can be set to 4:3 or to JUST. When a wide screen signal is detected at the Video terminal the TV will select the 16:9 aspect ratio.
4:3		This option will display a standard 4:3 picture without any stretching or compression. There will be vertical black lines down either side of the picture
ZOOM		This option allows you to magnify part of the picture. The coloured buttons let you change the position of the magnified area. Red V SIZE - Make picture Shorter. Green V SIZE + Make picture Taller. Yellow V POS - Move picture Down. Blue V POS + Move picture Up.
S-ZOOM		S-ZOOM displays part of the picture at greater magnification that the ZOOM mode does. The coloured buttons let you change the size of the magnified area. Red H POS - Move picture Left. Green H POS + Move picture Right. Yellow V POS - Move picture Down. Blue V POS + Move picture Up.
16:9	 <p>16:9 Signal 4:3 Signal</p>	The 16:9 option will display the picture at its maximum size. Signals in the 4:3 format will be stretched to fit the picture.
14:9		The 14:9 option will display a 4:3 signal in simulated wide screen. The picture is slightly stretched. It is also slightly cropped top and bottom.
JUST		JUST gives you a "best fit" option when showing 4:3 on wide screen. The centre of the picture is not affected but there is some stretching at the edges.

TELETEXT Operation

Teletext is only available on certain broadcast channels. The time taken to display the pages and sub-pages is set by the teletext transmitter and not by the television.

Teletext is also used for Closed Captioning of television programmes for the hearing impaired. Closed captions can be found on Teletext Page 801.

TOP (Table Of Pages) MODE

In TOPTEXT mode, the red button moves to the previous page number and the green button moves to the next page number. The yellow and blue buttons correspond to different subjects. These subjects can be accessed by Pushing the coloured button. This is the current preferred method of operation in Australia.

FASTEXT MODE

In FASTEXT mode, four differently coloured subjects are displayed at the bottom of the screen. To access more information about one of these subjects, push the corresponding colour coded button on the remote control. This is the current preferred method of operation in New Zealand.

LIST MODE

In LIST mode, four different coloured page numbers are shown at the bottom of the screen. Each of these numbers can be altered and stored in the TV's memory. These coloured page numbers correspond to the colour coded buttons on the remote control.

Please refer to page 21 for instructions on how to change modes between TOP/FASTEXT and LIST.

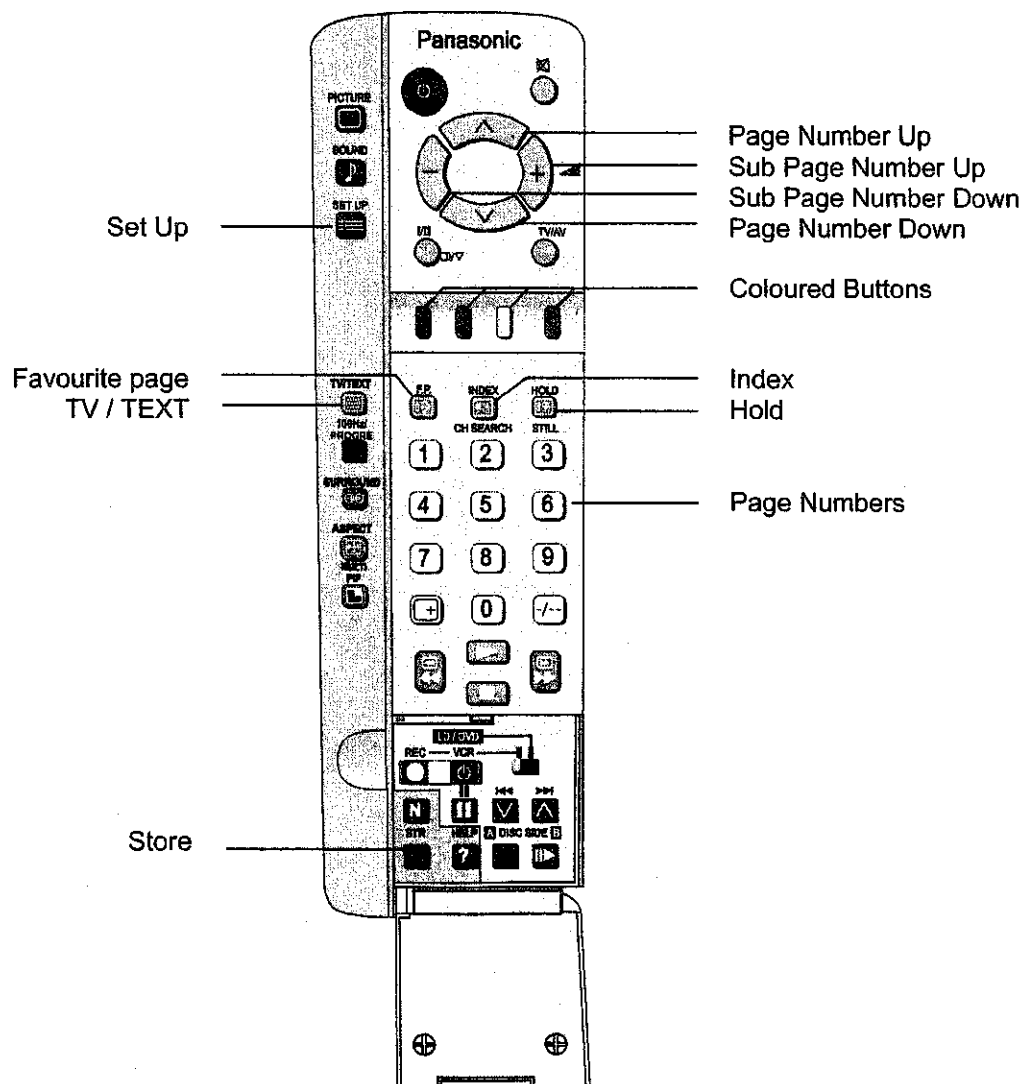

TELETEXT Operation

BUTTON

WHAT IT DOES



F.P. (FAVOURITE PAGE)

This feature will store a favourite page in the TV memory.

1. The TV must be in the LIST mode, receiving a teletext broadcast and the programme number must be between 1 and 25.
2. Push the Blue button.
3. Select the page number.
4. Push and hold the STR button.
5. The page number is now stored.

Push F.P. to recall this page.

SET UP



SET UP

Used with the Coloured buttons to access the Reveal, Full / Top / Bottom, Display Cancel and Time Text functions.

Push the TV/TEXT Button  to return to normal television viewing.

TV/TEXT



TV / TEXT

Pressing this button switches the screen between:

- TELETEXT
- Television picture on the left of the screen and the TELETEXT on the right of the screen.
- Normal television viewing.

When TEXT is on, the sound from the broadcast channel is still audible. To adjust the volume press the Sound  button or the F button to display the volume indicator. The volume can then be adjusted normally.

STR



STR

This button is used to store page numbers into the coloured buttons or the Favourite Page button. The STR button is located behind the remote control door.



PAGE NUMBERS UP AND DOWN

These buttons are used to move to higher or lower page numbers.



SUB PAGE NUMBERS DOWN AND UP

These buttons are used to move to higher or lower sub page numbers.



COLOURED BUTTONS

These buttons refer to different page numbers in LIST mode and different subjects in TOP mode.

INDEX



INDEX

Pressing this button returns you to the main index page.

HOLD



HOLD

Some TELETEXT pages contain multi-page information. Use this button to stop the page changing. Push it again to release the hold.

TELETEXT Operation



PAGE NUMBER BUTTONS

These buttons allow you to directly enter the page number that you want to view.

REVEAL

Some Text pages contain concealed information, e.g. the solution to a puzzle. To reveal this information Push the Set Up button  followed by the Red button. To hide the information, push the Red button again.

F/T/B

(FULL / TOP / BOTTOM)

This button is used when difficulty is experienced in reading text on the screen. To operate the F/T/B Push the Set Up button  followed by the Green button. Operating the F/T/B expands and displays the upper half of the screen. Operating the F/T/B Button again expands and displays the lower half of the screen. Operating the F/T/B Button a third time returns the display to normal condition.

DISPLAY CANCEL

If you wish to watch the television while you are waiting for a page to be transmitted you can use the DISPLAY CANCEL function.

This function is not available (or necessary) when the picture and the TELETEXT are both being displayed side by side.

Push the Set Up button  followed by the Yellow button to view the TV picture while waiting for a teletext page to be transmitted. When found, the page number will be displayed at the top left of the screen.

News Flash or Other Updates



When a news flash page (or another page which provides regular updates) has been selected Push the Set Up button  followed by the Yellow button to view the TV picture. When a news flash is received the page number will be displayed on the screen. Push the Yellow button to display the news flash.

TIME TEXT *

When a Page has more than one screen (sub-page) of information, you may have to wait for some time before the sub-page you require becomes available. With this function it is possible to enter the number of the desired sub-page.

1. Select Text Mode and choose a page.
2. Push the Set Up button  followed by the Blue button. T**** will be displayed at the top left of the screen.
3. Enter the sub page number before the T**** disappears. The sub-page number must be entered as a four digit number e.g. sub-page 3 would be entered as 0003. (If in LIST mode, a "T" will appear in the current box at the bottom).
4. Push the Yellow button to view the TV picture while waiting for the sub-page to be found. (This function is not necessary when the picture and the TELETEXT are both being displayed side by side).
5. When the page has been found, push the Yellow button

To clear the page perform one of the following:

- Push the Set Up button. 
- Select a new page number.
- Push the TV/TEXT Button  to return to normal television viewing.

* Note: TIME TEXT is not currently available in Australia.

Please refer to drawing on Page 24 for location of Teletext Control Buttons.

Tuning Menu

SYS Select

This option allows you to switch the television system between the Australian and the New Zealand / Indonesian system.

Using the Front Panel

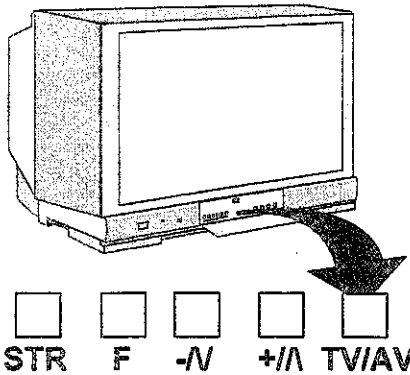

1. Push the **F** button repeatedly until the Tuning Mode is reached.

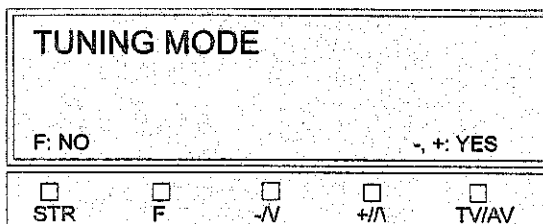

2. Push the **-/V** or **+/A** Button to access the Tuning Menu.
3. Push the **F** button to select SYS SELECT.
4. Push the **-/V** or **+/A** Button to switch between AUSTRALIA and NZ/INDONES.
5. To return the television to normal operation push the **TV/AV** button on the remote control or repeatedly push the **F** button until the volume display appears.

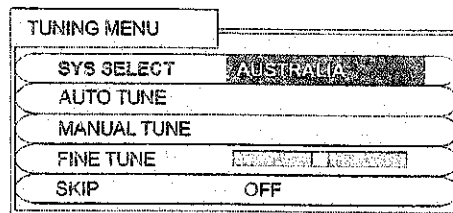

Using the Remote Control

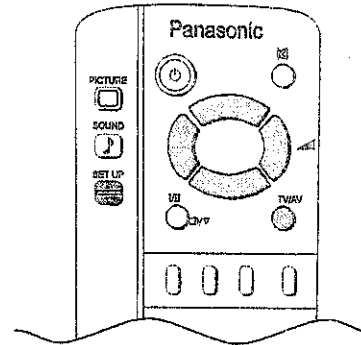

1. Push the Set Up **SET UP** button.
2. Push the **TV** or **TV/AV** button to access the Tuning Menu.
3. Push the **TV** or **TV/AV** button to select the Tuning Menu.
4. Push the **TV** or **TV/AV** button to select the SYS SELECT.
5. Push the **TV** or **TV/AV** button to switch between AUSTRALIA and NZ/INDONES.
6. Push the **TV/AV** button to return the television to normal operation.

Push the **TV/AV** button at any time to return the television to normal operation.

Tuning Menu

Auto Tune

This television has been factory tuned to all major city channels. Use the automatic tuning procedure only if you wish to reset ALL Programme Location Numbers. Refer to "Manual Tune" on page 29 if you only want to retune one or two Programme Location Numbers.

The television should be switched ON and the TV/AV Switch set to TV.

When you start the automatic search, the television will automatically search for television broadcasts through both VHF bands and the UHF band. During this process all of the available television broadcast channels will be automatically allocated to sequential Programme Number locations.

Using the Front Panel

1. Push the **F** button repeatedly until the Tuning Menu is reached.
2. Push the **- / V** or **+ / \wedge** button to access the Tuning Menu. (See page 27).
3. Push the **F** button to access the Auto Tune.
4. Push **- / V** or **+ / \wedge** button to start the search.

Using the Remote Control

1. Push the SET UP  button.
2. Push the **\wedge** or **V** button to select the Tuning Menu. (See page 27).
3. Push the **-** or **+** button to access the Tuning Menu.
4. Push the **\wedge** or **V** button to select the Auto Tune.
5. Push the **-** or **+** button to start the Auto Tune.

The television will automatically allocate each received broadcast signal to a Programme Number, starting at position number 1. As each station is stored the Panasonic logo will appear momentarily. The operation will cease when all available channels have been tuned.

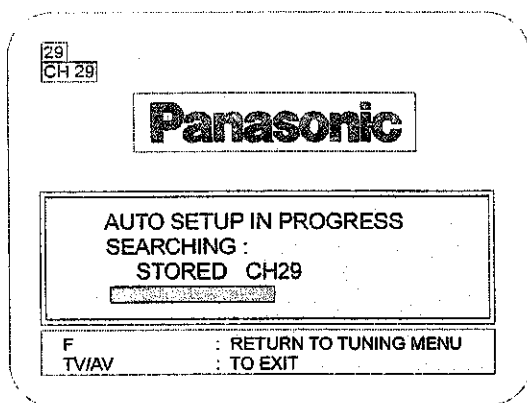

Push the **F** button to return the television to the Tuning Menu.

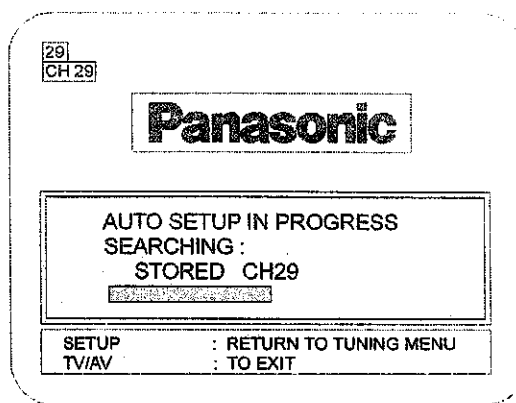

Push the Set Up  button to return the television to the Tuning menu.

Push the  button on the remote control to return the television to normal operation.

Tuning Menu

Manual Tune

This Television has been factory tuned to all the major city channels. Use this tuning procedure only if you wish to reset individual Programme Numbers.

The television should be switched ON and the TV/AV Switch set to TV.

Using the Front Panel

1. Push the **F** button repeatedly until the Tuning Menu is reached.
2. Push the **- / V** or **+ / \wedge** button to access the Tuning Menu. (See page 27).
3. Push the **F** button to access the Manual Tune.
4. Push the **- / V** or **+ / \wedge** buttons to select the Manual Tune.

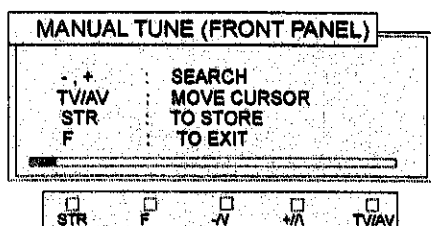

5. Push the **F** button to switch to "Change Programme".
6. Use the **- / V** or **+ / \wedge** buttons to select the programme location number to tune.
7. Push the **F** button to switch to "Search".
8. Push the **- / V** or **+ / \wedge** Button to start the search.
9. The television will automatically search for the next broadcast signal. As each station is found the search will stop. If you do not want this station restart the search.
10. Push the **STR** to store the selected station.
11. Push the **F** button to return the television to the Tuning Menu.
12. To return the television to normal operation push the **F** button repeatedly until the volume display appears.

Using the Remote Control

1. Push the Set Up  button.
2. Push the **\wedge** or **V** button to select the Tuning Menu. (See page 27).
3. Push the **-** or **+** button to access the Tuning Menu.
4. Push the **\wedge** or **V** button to select the Manual Tune.

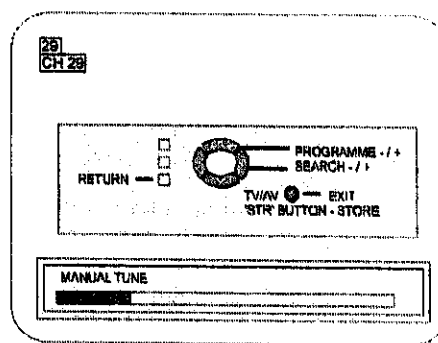

5. Push the **-** or **+** button to access the Manual Tune.
6. Push the **\wedge** or **V** button to select the programme location number to tune.
7. Push the **-** or **+** button to start the search.
8. The television will automatically search for the next broadcast signal. As each station is found the search will stop. If you do not want this station restart the search.
9. Push the **STR** to store the selected station.
10. Push the Set Up button to return the television to the Tuning menu.

Push the  button on the remote control to return the television to normal operation.

Tuning the Television to a VCR

1. Turn the VCR On and either start a known tape playing or set the VCR Test Signal, if fitted, to On (refer to the VCR operating instructions).
2. Repeat steps 2, 3 and 4 of the Manual Tuning procedure above. The television will treat the VCR as if it was a normal television broadcast station.

NOTES:

1. The antenna lead must be connected to the VCR and the VCR RF-Out must be connected to the TV RF-In. Please refer to page 39.
2. The picture and sound quality are usually much better if the VCR is connected using the AV Terminals. Please refer to page 40.

Tuning Menu

Fine Tune

in areas of poor reception or constant interference a slight adjustment to the tuning may improve the picture quality.

Using the Front Panel

1. Select the Programme location number you want to fine-tune.
2. Push the **F** button repeatedly until the Tuning Mode is reached. (See page 27).
3. Push the **- / V** or **+ / ^** button to access the Tuning Menu.
4. Push the **F** button to access Fine Tune.

Using the Remote Control

1. Select the Programme location number you want to fine-tune.
2. Push the Set Up  button.
3. Push the **^** or **V** button to select the Tuning Menu. (See page 27).
4. Push the **-** or **+** button to access the Tuning Menu.
5. Push the **^** or **V** button to select the Fine Tune.

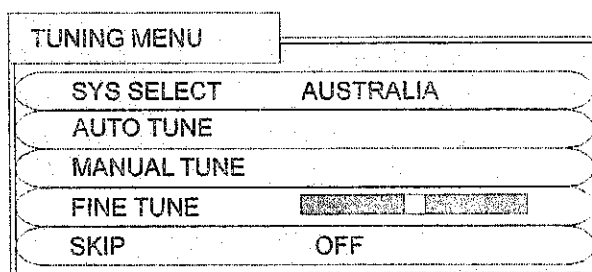

5. Push the **- / V** or **+ / ^** button to fine tune the station.
6. The television will fine tune in the direction chosen by you.
7. Push the **STR** to store the selected station.
8. Push the **F** button to return the television to the Tuning Menu.
9. To return the television to normal operation push the **F** button repeatedly until the volume display appears.
10. The on screen display will disappear after a few seconds.

6. Push the **-** or **+** button to start the fine tune.
7. The television will fine tune in the direction chosen by you.
8. To store the selected station, push the **STR** button.
9. Push the Set Up button twice to return the television to the Set Up menu.

Push the  button on the remote control to return the television to normal operation.

Canceling the Fine Tuning

To cancel the Fine Tuning follow the Manual Tune procedure on page 29.

Tuning Menu

Skip

This option allows you to "Skip" (bypass) the unused or undesired Programme Numbers. The Function is only applicable when the Programme Number Up or down buttons are Pushed. The use of the remote control Direct Programme Number Buttons overrides the Skip function.

Using the Front Panel

1. Select the Programme location number you want to "Skip"
2. Push the **F** button repeatedly until the Tuning Mode is reached. (See page 27).
3. Push the **- / V** or **+ / ^** button to access the Tuning Menu.
4. Push the **F** button to select SKIP.

Using the Remote Control

1. Select the Programme location number you want to "Skip".
2. Push the Set Up  button.
3. Push the **^** or **V** button to access the Tuning Menu. (See page 27).
4. Push the **-** or **+** button to select the Tuning Menu.
5. Push the **^** or **V** button to select the SKIP.

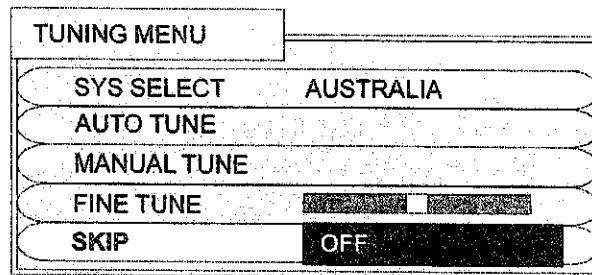

5. Push the **- / V** or **+ / ^** button to turn the SKIP on or off.
6. To store the SKIP setting, push the **STR** button.
7. To return the television to normal operation push the **F** button repeatedly until the volume display appears.
8. The on screen display will disappear after a few seconds.

6. Push the **-** or **+** button to turn SKIP on or off.
7. To store the SKIP setting, push the **STR** button.

Push the  button on the remote control to return the television to normal operation.

Geomagnetic Correction

Magnetic interference may come from such things as unshielded motors, moving the TV while it is switched ON, turning off a vacuum cleaner too close to the TV, lightning strikes nearby or many other things.

Slight tilting of the picture may be noticeable or coloured patches may sometimes appear at the corners of the screen (colour purity).

The Geomagnetic Correction feature can be used to eliminate some interference problems.

Quite often simply switching your Television OFF with the Power On/Off Switch (not with the remote control) for 30 minutes and then switching it back ON will cure the problem.

Geomagnetic corrections can be made from the remote control or from the TV set.

Using the Front Panel

1. Push the **F** button repeatedly to access the Geomagnetic Correction Menu.

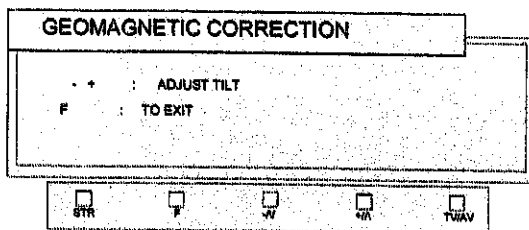

2. Push **- / V** or **+ / ^** to adjust the picture tilt or coloured patches as necessary.

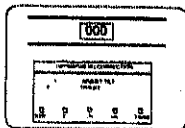

The adjustment range is from -8 to +8.

3. Push the **F** button to return to normal viewing.

Using the Remote Control

1. Push the **SET UP** button.
2. Select the Geomagnetic Correction Menu by Pushing the **^** or **V** button.
3. Push **-** or **+** to access the Geomagnetic Correction.

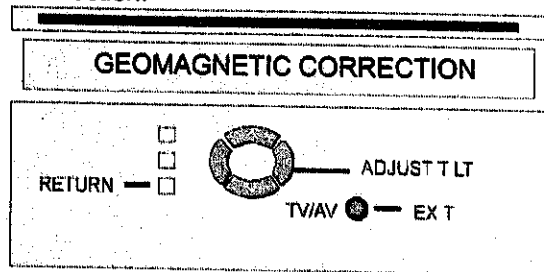

4. Push **-** or **+** to adjust the picture tilt or coloured patches as necessary.

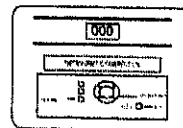

The adjustment range is from -8 to +8.

5. Push the **SET UP** button to return the TV to the Set Up Menu.

Push the  button on the remote control to return the television to normal operation.

Helpful Hint

1. If geomagnetic changes cause colour patches on the screen switch your Television OFF with the Power On/Off Switch (not with the remote control) for 30 minutes and then switch it back ON.
2. Adjustment for geomagnetic should be performed every time the location of the TV is changed.
3. In some cases colour patches will not be completely eliminated even after adjustment, particularly in ferroconcrete buildings and other structures susceptible to geomagnetic effects. In these cases the TV location will have to be changed.

Remote Control VCR/LD/DVD Operation

This remote control has been designed to work with a variety of VCRs, Laser Disc players and DVD players.

Please refer to page 35 for details of manufacturers' codes.

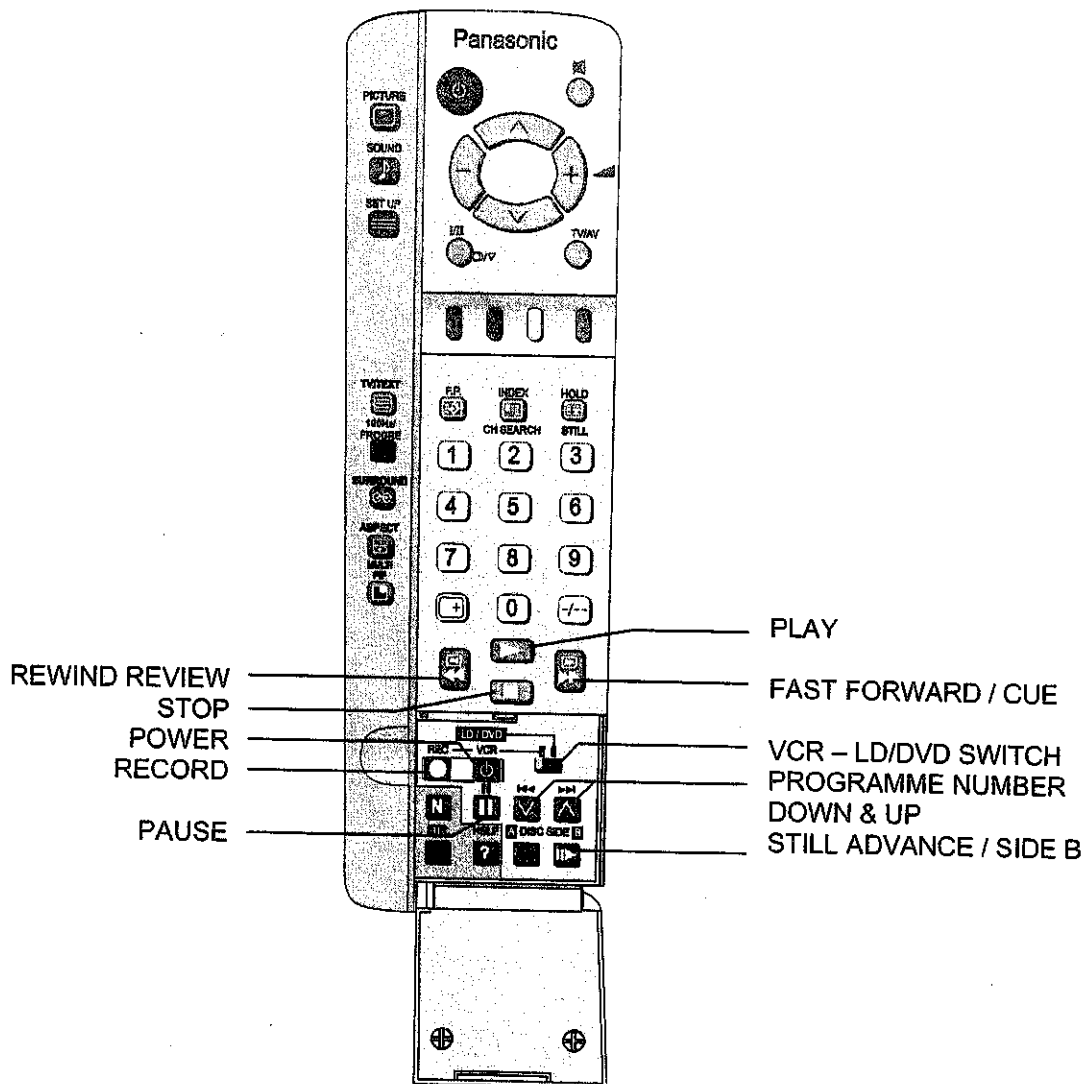











* WARNING:

Unauthorised recording of material from Television Broadcasts or from other video and / or audio sources may contravene copyright laws.

Remote Control VCR/LD/DVD Operation





Remote Control VCR/LD/DVD Buttons

Button	Function	
	VCR	LD/DVD
	<p>REWIND / REVIEW Used to rewind the tape quickly or watch the tape in reverse.</p>	<p>REWIND / REVIEW Used to play the disc in reverse while watching the picture.</p>
	<p>STOP Used to stop the VCR.</p>	<p>STOP Used to stop the LD/DVD.</p>
	<p>POWER BUTTON Used to switch the VCR ON or OFF (Standby).</p>	<p>POWER BUTTON Used to switch the D/DVD ON or OFF (Standby).</p>
	<p>RECORD Push this button and the PLAY button to start recording.</p>	
	<p>PAUSE Pauses the tape during play.</p>	<p>PAUSE Pauses the disc during play.</p>
	<p>PLAY Used to Start the VCR playing.</p>	<p>PLAY Used to start the LD/DVD playing.</p>
	<p>FAST FORWARD / CUE Used to wind the tape forward quickly or to watch the tape at fast speed.</p>	<p>FAST FORWARD / CUE Used to watch the disc at fast speed.</p>
	<p>VCR Switch Setting Selects VCR.</p>	<p>LD/DVD Switch Setting Selects LD/DVD.</p>
	<p>PROGRAMME NUMBER DOWN AND UP Used to select the next Higher or Lower Programme Number.</p>	<p>PROGRAMME SKIP Used to skip tracks on the disc.</p>
	<p>STILL ADVANCE Used to advance the tape one frame at a time. Used with the Pause button.</p>	<p>DISC SIDE B SELECTION Used to select the B-side of the disc.</p>
		<p>DISC SIDE A SELECTION Used to select the A-side of the disc.</p>

Remote Control VCR/LD/DVD Operation

Manufacturers' Code Settings

This remote control has been designed to work with a variety of VCRs, Laser Discs and DVD players. In order for this to occur, the setting for the VCR, LD or DVD must be programmed into the Remote Control.

- To set a VCR, slide the remote control VCR-LD/DVD switch  to VCR.
To set a LD or DVD, slide the remote control VCR-LD/DVD switch  to LD/DVD.
- Push the remote control VCR - LD/DVD Power Button  and keep it Pushed.
- Enter the Manufacturer's two-digit code number using the remote control Number Buttons (The codes are shown below).
- Push the STOP  button .
- Release the remote control VCR or LD/DVD Power button.
- Check the operation of the VCR, LD or DVD. If it does not operate correctly, repeat steps 1 to 5 and use an alternate code (if there is one).

VCR CODES

Manufacturer	Code	Manufacturer	Code
Panasonic / National	10, 11, 12, 13	NEC	40, 41, 42, 43
AIWA	15, 16	ORION	45, 46
FUJITSU	20	Philips	50
HITACHI	25, 26, 27	SANYO	55, 56, 57, 58
JVC	30, 31, 32	SHARP	60, 61
MITSUBISHI	35, 36	SONY	65, 66, 67
		TOSHIBA	70, 71

LD CODES

Manufacturer	Code	Manufacturer	Code
Panasonic	10, 11, 12, 13	SAMSUNG	30
KENWOOD	15, 16	SHARP	35
PHILIPS	20	SONY	40, 41, 42, 43
PIONEER	25		

DVD CODES

Manufacturer	Code	
Panasonic	70	

NOTES:

- If the batteries are removed from the remote control the Manufacturer's codes are lost and must be reprogrammed.
- The list of manufacturer's codes is given as a guideline only. Panasonic cannot guarantee that any other manufacturer's product will work with this remote control.

Connecting Equipment to the TV

Front Panel Connections

Connecting to the RGB Input Terminals

Behind the front panel door is the headphone socket, the AV3 input and the RGB input.

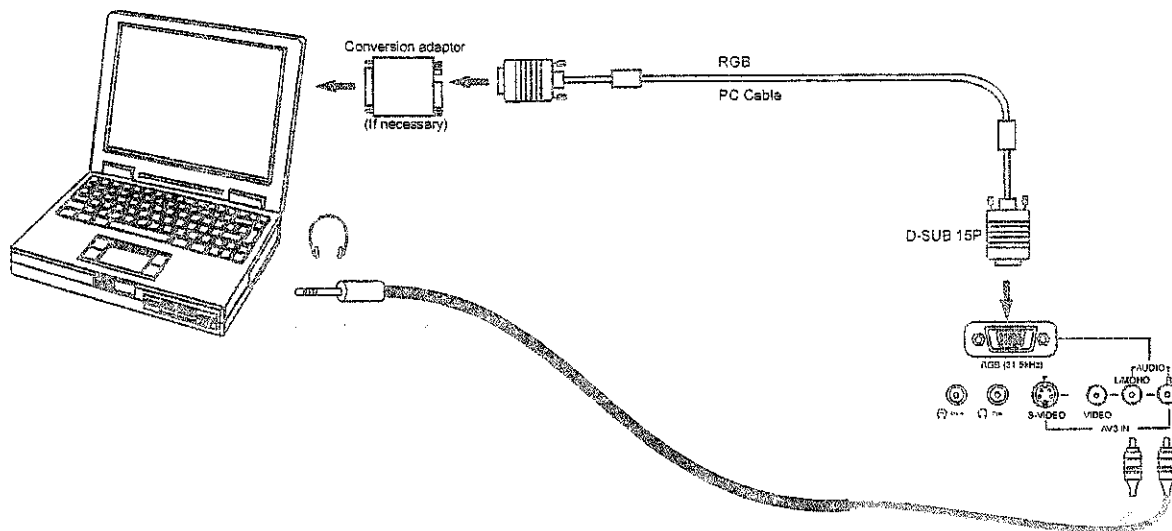

- Personal computers (PC) with 640 x 480 (31.5kHz / 60Hz) or 640 x 400 (31.5kHz / 70Hz) resolution can be connected to this television.
Note: the display will prompt you to set the resolution to 640 x 480.
- The computer must be set to High Colour (16 bit).
- In some cases other PCs may not work with this TV set.
- There is no audio signal in RGB mode.
- Connect the sound cables to the AV3 Audio Input terminals.
- Some computers such as PC-98 and Macintosh require a commercially sold adapter between the RGB cable (D-Sub 15P) and the computer.
- There is no need for an adaptor when using computers with a DOS/IV compatible D-Sub 15P terminal.
- With some computers it may be necessary to press Function F4 twice to give a display on the television.
- There are no computer connection cables included with this television.

Signal names for D-Sub 15P Connector

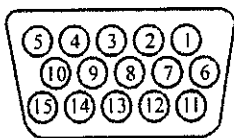

Pin layout for RGB Terminal

Pin No.	Signal Name	Pin No.	Signal Name	Pin No.	Signal Name
1	R	6	GND	11	GND
2	G	7	GND	12	NC
3	B	8	GND	13	HD/SYNC
4	GND	9	NC	14	VD
5	GND	10	GND	15	NC







GND is Ground

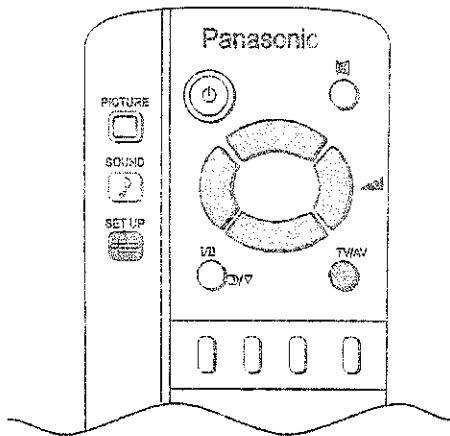





NC is Not connected

Connecting Equipment to the TV

Adjusting the RGB Picture

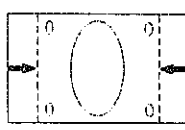
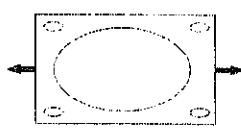

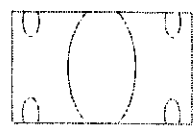
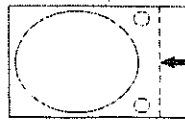
1. Push the TV/AV button .
 2. Push the Yellow button to select RGB mode. The yellow button switches between RGB and AV3.
 3. Push the SET UP button .
 4. Move to the option using  or .
 5. Adjust the chosen option using the  or  buttons.
- Push  at any time to return to watching TV.

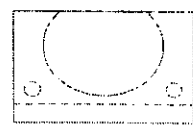
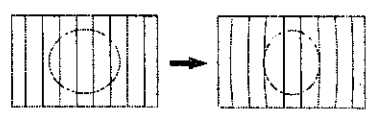
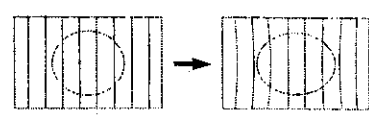
OPTION	EFFECT	
	Push 	Push 
H - SIZE		
V - SIZE		
H - POS		
V - POS		
PARABOLA		

Connecting Equipment to the TV

Rear Panel Connections

When using a VCR with the television *always* connect the Aerial to the VCR and connect an RF Cable (not supplied) between the VCR RF-Out and the television RF-in.

You can watch videos by either tuning the television to the VCR (see page 29) or by connecting the VCR to the rear AV terminals.

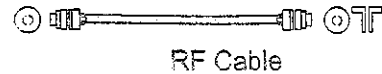

Note: When connecting a mono VCR through the RF-In, please switch the TV to mono.

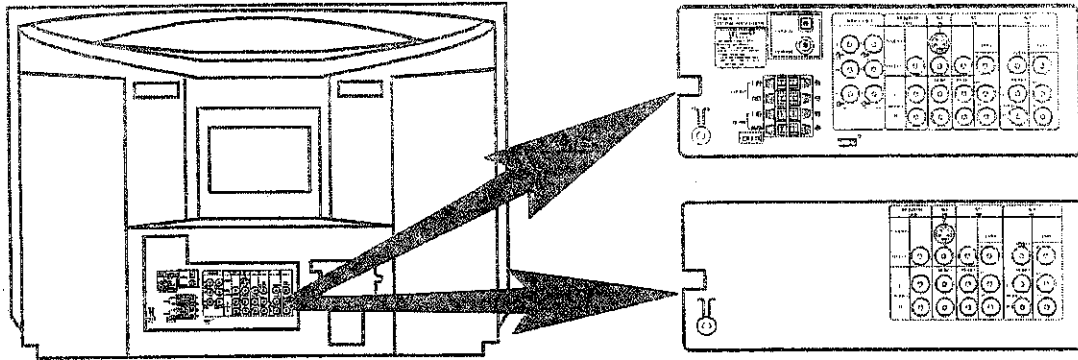

Monitor Out

The Monitor Out terminals reproduce the signals currently on the television screen. The on-screen signals could be a television programme or signals connected to one of the AV inputs.

The Monitor Out facility can be used to allow one video source (videotape, video disc etc.) to be connected to more than one television. Connect the Monitor out from this television to the AV input of the second television.

If a video recorder is connected to the Monitor Out and video sources (VCR, video disc, camera etc.) are connected to one or more of the AV inputs, the television becomes a visual display for tape editing or copying. *

The Monitor Out Audio can also be connected to a stereo amplifier or other hi-fi equipment.

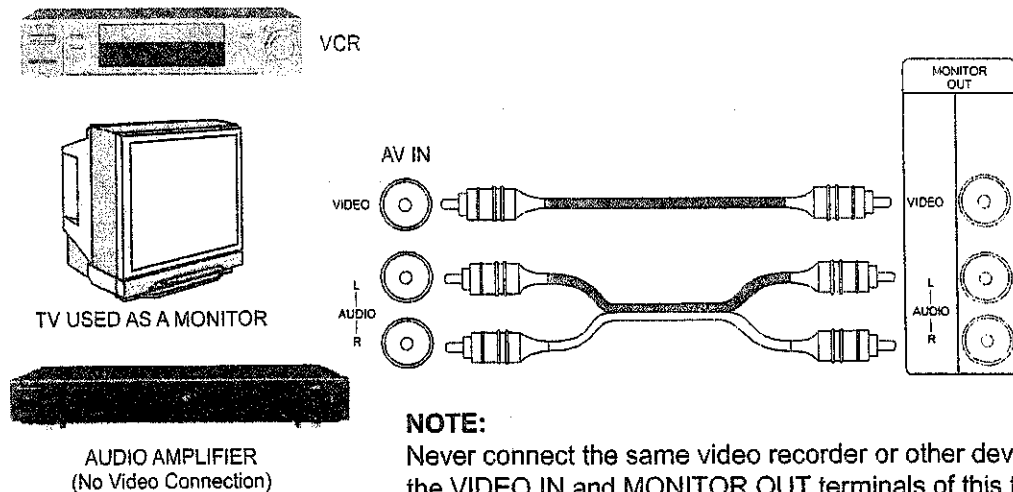

* WARNING

Unauthorised recording of material from Television Broadcasts or from other video and/or audio sources may contravene copyright laws.

Connecting Equipment to the TV

***** NOTE *****

Headphones and connecting cables for Antennas, VCRs, LDs DVDs, Amplifiers and Speakers etc. are not supplied with this television.

Front Panel Connections

The front input terminals allow quick and easy access for computer games, video cameras and other equipment which is not usually permanently connected.

AV Equipment

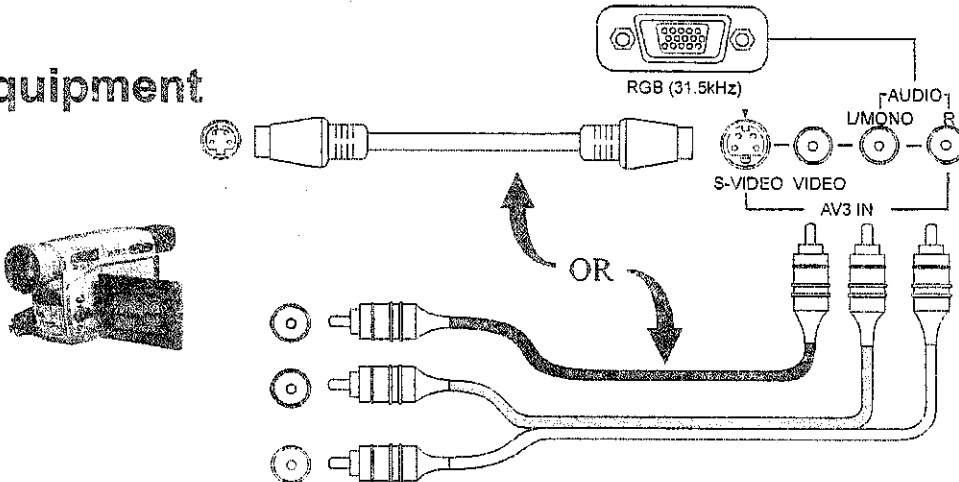

Headphones

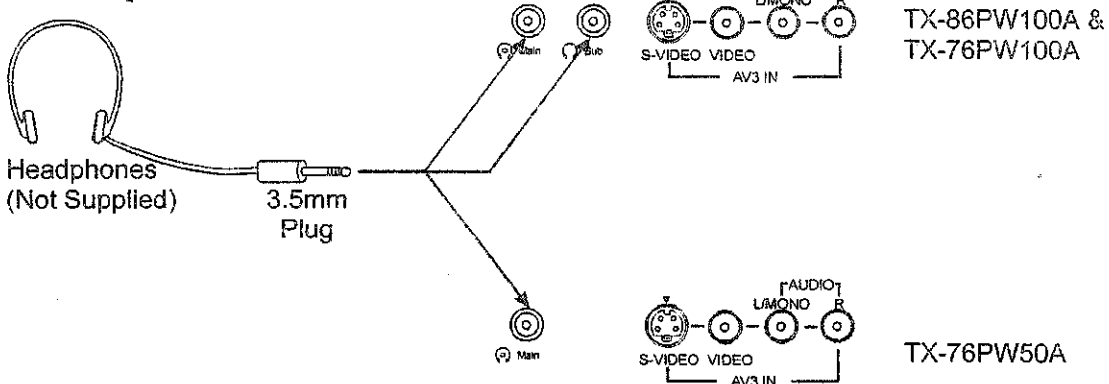

Screen Condition		Speaker Sound	Main Headphones	Sub Headphones	Monitor Output
Single picture/ Teletext	A	A (Stereo)	A (Stereo)	A (Stereo)	A (Stereo)
Picture in Picture	<div style="border: 1px solid black; width: 100px; height: 100px; display: flex; align-items: center; justify-content: center;"> <div style="border: 1px solid black; width: 60px; height: 60px; display: flex; align-items: center; justify-content: center;">A</div> <div style="border: 1px solid black; width: 20px; height: 20px; display: flex; align-items: center; justify-content: center;">B</div> </div>	A (Stereo)	A (Stereo)	B (Mono)	A (Stereo)
Picture in Picture CHANGE	<div style="border: 1px solid black; width: 100px; height: 100px; display: flex; align-items: center; justify-content: center;"> <div style="border: 1px solid black; width: 60px; height: 60px; display: flex; align-items: center; justify-content: center;">B</div> <div style="border: 1px solid black; width: 20px; height: 20px; display: flex; align-items: center; justify-content: center;">A</div> </div>	B (Stereo)	B (Stereo)	A (Stereo)	B (Mono)

Connecting Equipment to the TV

Connecting a Standard VCR to the AV Input

Most standard Video Cassette Recorders use RCA type video and audio connectors. If your VCR has different type connectors please refer to the VCR instruction book for details.

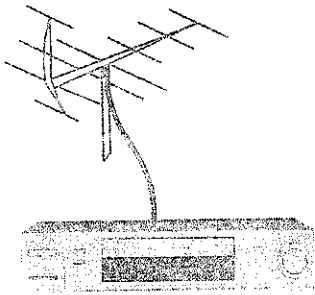

NOTE: A mono VCR can be connected to this television. Connect the VCR Audio out to the Left Audio input on the television. The sound will automatically be directed to both speakers.

Connecting S-Video Equipment to the AV Input

S-Video equipment uses a 4Pin Mini Din (Male) plug for the video and RCA plugs for the audio. When an S-Video cable is connected to an S-Video input terminal, the RCA video terminal for that AV position will be disconnected.

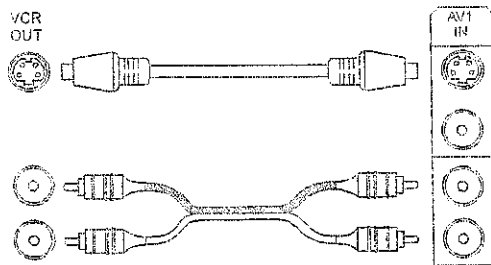
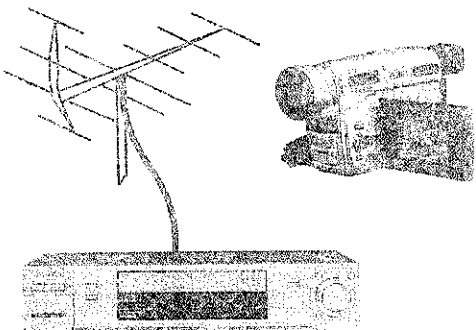
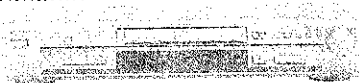

Connecting DVD Equipment to the AV Input

The audio and video inputs on the television are RCA type connectors. Connect the Y, PB and PR outputs from the DVD to the AV4 IN DVD Inputs on the television, as shown below. Connect the "AUDIO OUT" to the AV4 IN AUDIO terminals on the television.

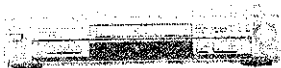

DVD PLAYER

Note: Some DVD players only have an RCA "VIDEO OUT" terminal. This can be connected to any of the VIDEO Inputs on the television. Connect the "AUDIO OUT" to the corresponding AUDIO terminals on the television.

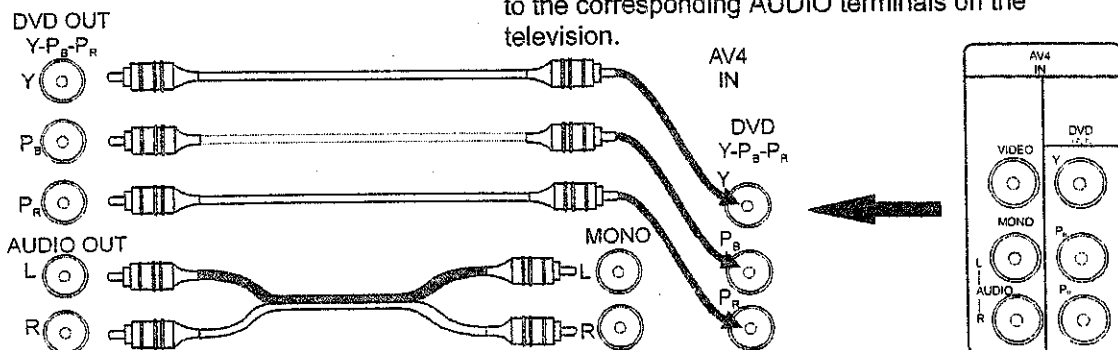

Connecting Equipment to the TV

Connecting the Audio Out Terminals (TX-86PW100A & TX-76PW100A)

The Audio Out sockets on the rear of the TV allow you to create a custom sound system using an external amplifier and external speakers.

You may decide, for example to use an external DTS/Dolby Digital amplifier to connect external left and right front speakers, left and right rear surround speakers and a subwoofer (LFE speaker) as shown below.

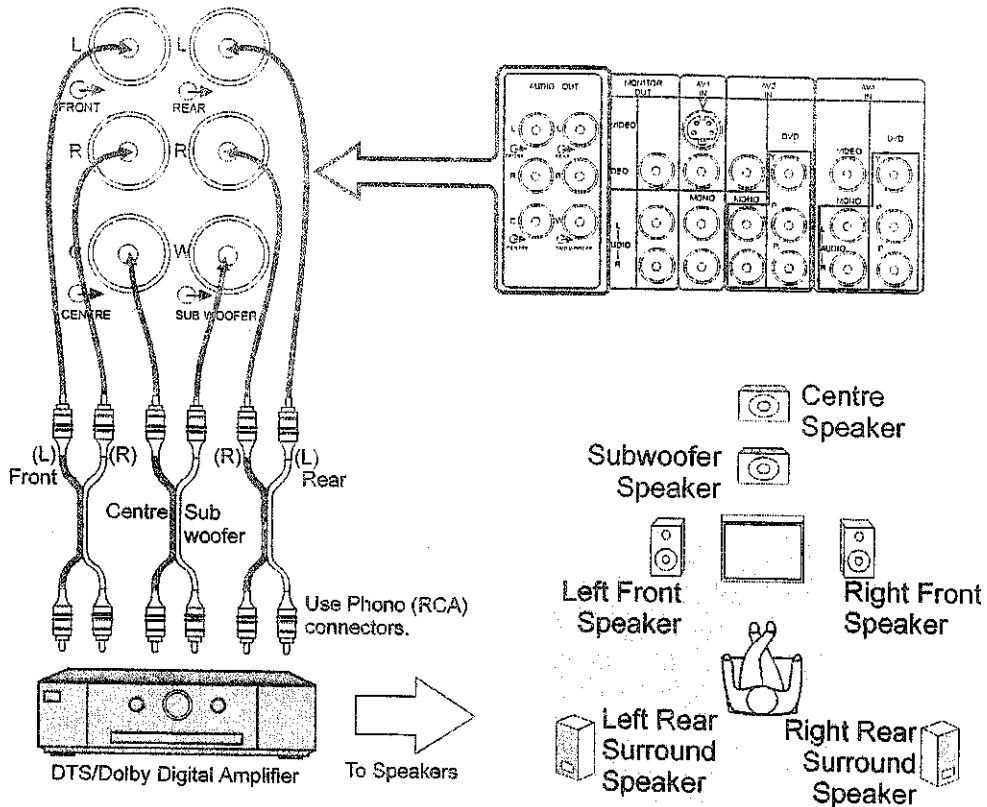

Connecting the Digital Audio Input (TX-86PW100A & TX-76PW100A)

Additional equipment can be connected to the rear of the AV1/AV2/AV3/AV4 and via the two digital audio input sockets (coaxial or optical).

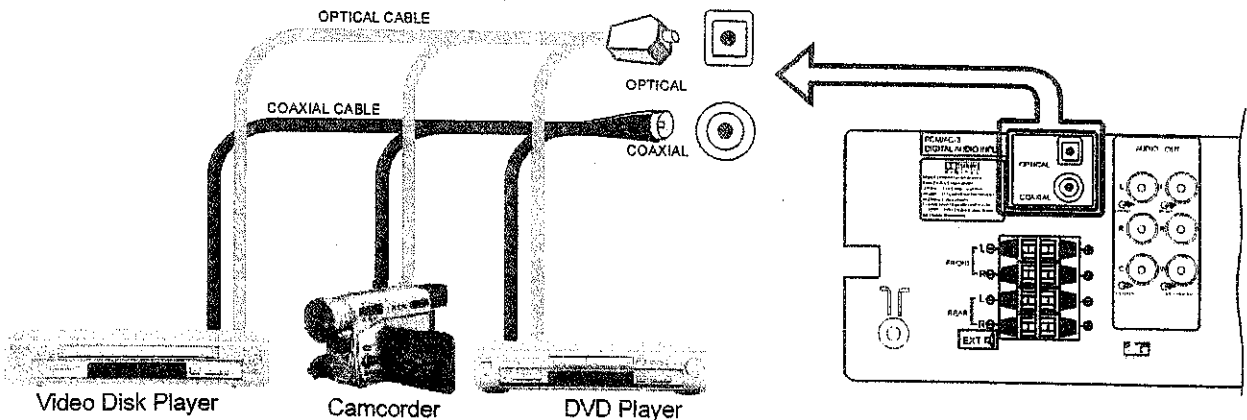

Connecting Equipment to the TV

Connecting the External Speakers (TX-86PW100A & TX-76PW100A)

The external speaker connections (EXT) on the rear of the TV allow you to create your own system using external speakers.

You may decide, for example, to connect external left and right front speakers and left and right rear surround speakers as shown here.

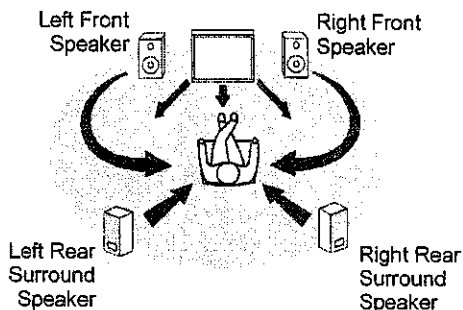

The TV must be turned *OFF* before connecting external equipment.

1. Twist the bare wire ends of the speaker wires before inserting into the speaker terminals.

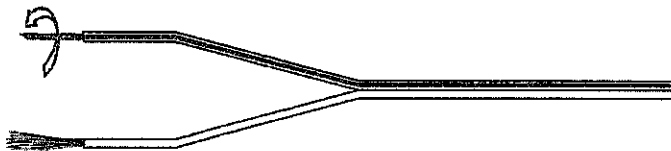

2. Insert into terminals.
Ensure that bare speaker wires are not touching and are fully inserted into the terminals.

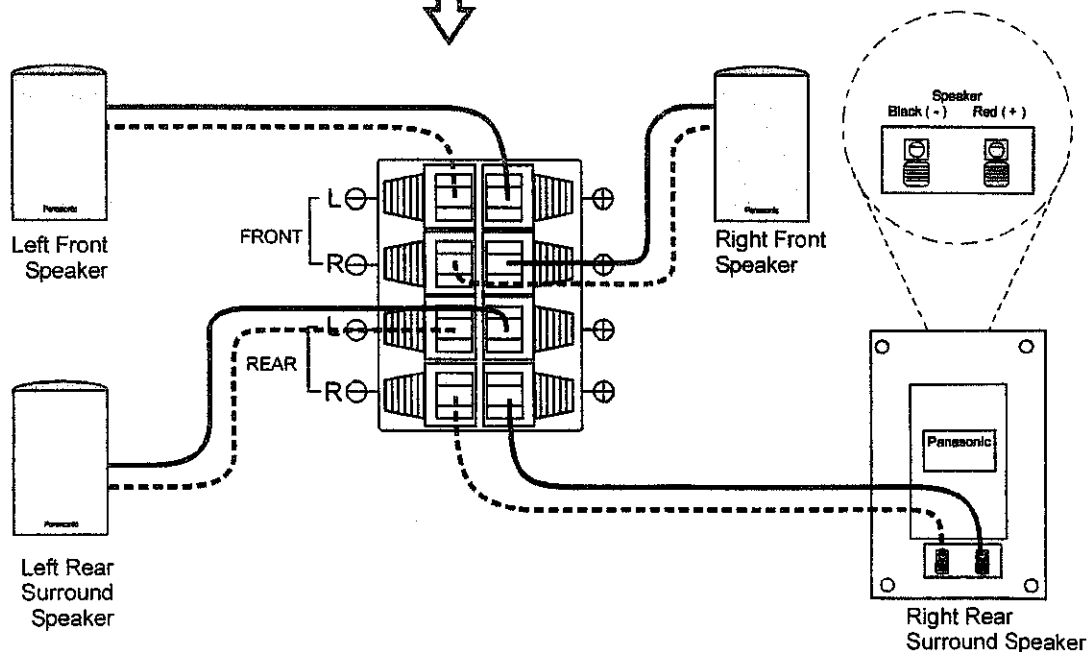
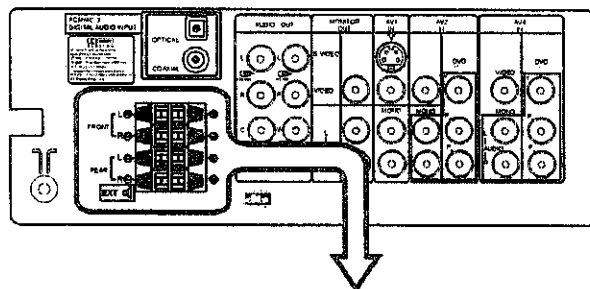
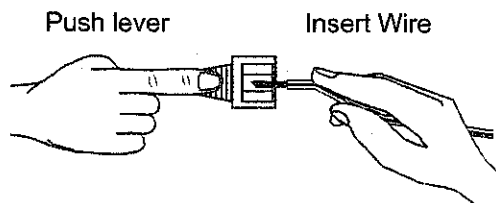

Customer Information

To keep your Panasonic Television in good working order please observe the following warnings and cautions. Please be careful with this television. Like all electrical equipment it can cause serious injury or damage if it is mistreated

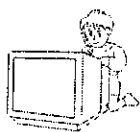

Danger
Do not insert foreign objects.
(Keep metal or easily inflammable objects out of this television).

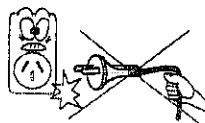

Danger
Always pull the plug out of the wall outlet by holding the plug itself.
Do not pull the plug by the power cord.



Danger: High Voltage
Do not remove the rear cover, as High Voltage components will be exposed.



Danger
Do not alter the power cord.
Do not use if the power cord or plug is damaged or if the plug does not fit tightly into the socket.

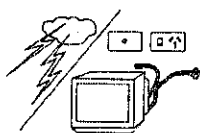

DO NOT touch the aerial cable and metal parts of the television when there is lightning around. During storms switch the television off. **DO NOT** leave in standby. Remove the plug from the wall socket.

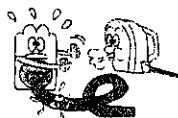

Do not allow the power cord to come into contact with flame or hot surfaces.



Do not place any containers of water or other liquids on or near this television.

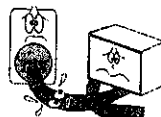

Do not place heavy objects on the power cord.

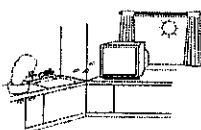

Do not place the TV in humid or dusty locations, or areas exposed to smoke or steam. Avoid exposing the television to direct sunlight or any other sources of direct heat.

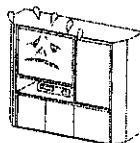

Adequate ventilation is essential. Allow a gap of at least 10cm around the TV, even in a cabinet or between shelves.

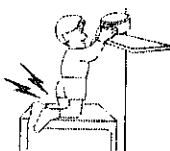

Do not stand or place heavy objects on top of the television.

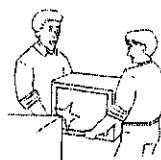

Do not subject the TV to any physical shocks. Always remove any connector cables when moving the TV. When moving the TV from one place to another wrap it in something protective.



Remove the Power Plug from the wall socket when the Television is not going to be used for an extended period of time.



Turn the power OFF before connecting other electrical equipment.

Safety First

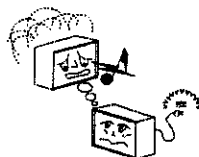

In the advent of unusual operation (e.g. odd sounds, smoke or aromas), turn the television Off and remove the power cord from the wall socket. Then call the Television Service Centre: this may reduce the possibility of expensive repair costs.

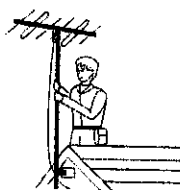

Any external aerial should be installed by a reputable qualified installer and should comply with Australian Standard AS1417.1.

Customer Information

The picture tube has a special coating.

- Please only use a soft cloth when you clean the surface of the picture tube
- The film can be easily scratched.
- DO NOT rub the surface with a hard material.
- DO NOT use salt water, insecticide, chloric or acidic cleaning solvent or cleaning agent with abrasive materials.
- DO NOT heat the screen surface to 80°C or higher.

Cleaning the Television

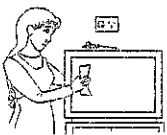

Cabinet and Picture Tube Care
The cabinet and picture tube can be kept in good condition by wiping with a clean, lint free cloth moistened with mild detergent and water. For safety, remove the plug from the power outlet when cleaning.



This television contains many plastic parts. For this reason **Do Not** use benzene, thinners or any solutions containing petroleum or other chemicals.

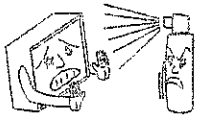

Do not spray insecticide or volatile solvent on the TV. **Do not** allow rubber and vinyl products to stay in contact with the TV for long periods of time. They may cause changes in paint quality.



Remove dirt and soiling by wiping with a soft cloth. Even if the television is heavily soiled do not apply cleaner directly to the unit. Soak a cloth in a solution of neutral cleanser thinned with water. Wring out the cloth, wipe the television clean and finish by wiping with a dry cloth.

Caring for the Remote Control

The lens of the Remote Control should be kept clean and free of dirt and grease. Use a soft cloth moistened with water and a mild detergent to keep the lens clean.

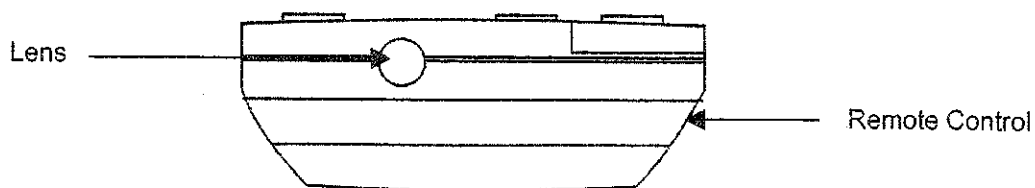

Customer Information

Frequently Asked Questions

Some minor problems can be corrected very quickly and easily without the cost of a service call. Panasonic has a Customer Care Centre that can answer most questions over the phone. Before you contact the Customer Care Centre with your question we have included the most commonly asked questions.

Question: Why are my channels on 1,2,3,4,5?

Answer: Someone has performed an "Automatic Search" tune of your television. You will have to retune each channel individually using the Manual Search Instructions on page 29.

Question: How do I get Channel 10?

Answer: You have three methods of selecting Channel 10

1. You can use the two digit channel selector on the remote control (- / - -). Press this button followed by the number 1 button, then the 0 button.
2. You can press the 9 button followed by the channel up button (\wedge).
3. You can tune channel 10 into another position such as programme location 0.

Question: My channel number is still on the screen. How do I turn it off?

Answer: If the channel number is a small green number on the top left of the screen, press the recall  button on the remote control. Any other channel number is one being broadcast by the television station. There is no way to turn this off.

Question: How do I tune my stations?

Answer: The instructions for tuning the stations are on page 28 for automatic tuning and on page 29 for tuning individual stations.

Question: I have done an auto tune because the book told me to. If I am only to do manual search why is automatic search first in the book?

Answer: The automatic search and the manual search each have specific uses. The reason for each is clearly described in the book. The reason that automatic search is described first is because this is the first option on the screen.

Question: Why does the screen turn blue?

Answer: The television has been designed so that the screen turns blue when the signal strength is very weak or nonexistent. The reasons may be:

1. The television station may have stopped transmitting.
2. You may have selected a programme number that has not yet been tuned.
3. You may have been watching a videotape or DVD and it has stopped playing.
4. Your aerial connection may have come loose.

Question: When I skip a station why is a picture still coming up when I press the number that the channel is on?

Answer: The Skip operation only works when you use the Channel Up (\wedge) or Down (\vee) Buttons.

Question: When I use the channel up or channel down why don't I get all the channels?

Answer: Some of the channels may be "Skipped". See page 31.

Question: Why doesn't the channel change when I press the channel button?

Answer: The television might be switched to Teletext mode. If it has been switched to text mode for closed captions and they are not being transmitted there may not be any indication on the screen to let you know that you are in Text mode. See pages 24, 25 and 26.

Question: I turned my television to Standby with the remote control and then I turned it off with the power switch. I turned the TV back on with the power switch but it's still in Standby and I can't find my remote control. How can I turn the TV back on?

Answer: Press the front panel Up (+ / \wedge) or Down (- / \vee) button. See page 9.

If the answer to your problem is not in this list, determine the symptoms and make a few simple checks as shown on the next page. The location of the nearest service centre can be obtained from the Panasonic Customer Care Centre on 132600.

Troubleshooting

Before calling for service, determine the symptoms and make a few simple checks as shown below.

Picture

Sound

Check



Snowy Picture



Noisy Sound

Aerial Location, Direction or Connections.
If you are watching a tape playback check the state of the Video heads – they may need to be cleaned or replaced. The tape may be old. Check the tracking.

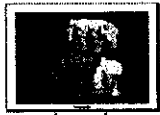

Multiple Image



Normal Sound

Aerial Location, Direction or Connections.

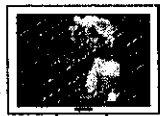

Interference



Noisy Sound

Electrical Appliances, Motorcycles, Cars or Fluorescent Lamps.



Normal Picture

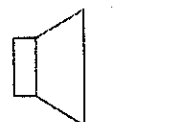

No Sound

Volume (Check the Mute function)



No Picture

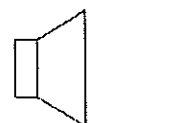

No Sound

Not plugged in, switched OFF or Set to Stand By. Check volume, brightness, and contrast levels.
Various internal safety devices may have been triggered. Switch the TV off for a few minutes and try again.



No Colour

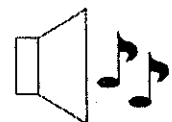

Normal Sound

Colour Control.
If the picture is from a tape playback, try adjusting the tracking.



Scrambled



Normal or Weak Sound

Retune the Television. Refer to page 29.



Colour Patches



Normal Sound

Magnetic Interference from unshielded equipment or the television may have been moved while it was switched ON. (Switch the television OFF with the main power switch and leave it OFF for about 30 minutes). Refer to page 32.

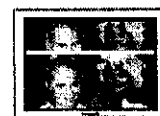

Rolling Picture

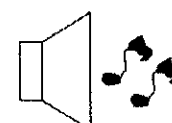

Noisy Sound

Picture Menu (Refer to page 14).
Sound Menu (Refer to page 16).

Specifications

Tuning System	Frequency synthesized 100 Position (0 to 99).																			
RF Channels	VHF 0 to 12 UHF 21 to 69 S'1 to S'3 S1 to S41	PAL B PAL G HYPER TUNER																		
Receiving Systems	<table border="1"> <tr> <td>1. PAL B/G</td> <td colspan="3">Reception of Off air broadcasts</td> </tr> <tr> <td>2. NTSC 4.43</td> <td colspan="3">Playback from Video Tape Recorders</td> </tr> <tr> <td>3. NTSC 3.58</td> <td colspan="3">Playback from Special Video Tape Recorders and Special Video Disc Players</td> </tr> <tr> <td>4. PAL 60Hz</td> <td colspan="3">(Via the AV Sockets) only.</td> </tr> </table>				1. PAL B/G	Reception of Off air broadcasts			2. NTSC 4.43	Playback from Video Tape Recorders			3. NTSC 3.58	Playback from Special Video Tape Recorders and Special Video Disc Players			4. PAL 60Hz	(Via the AV Sockets) only.		
1. PAL B/G	Reception of Off air broadcasts																			
2. NTSC 4.43	Playback from Video Tape Recorders																			
3. NTSC 3.58	Playback from Special Video Tape Recorders and Special Video Disc Players																			
4. PAL 60Hz	(Via the AV Sockets) only.																			
Power Requirements	220 ~ 240Volts \pm 10% 50Hz																			
Power Consumption	TX-86PW100A	228W Max	3W Stand-By																	
	TX-76PW100A & TX-76PW50A	211W Max	3W Stand-By																	
Chassis	EURO7																			
Picture Tube	TX-86PW100A	86cm Viewable (Measured diagonally)																		
	TX-76PW100A & TX-76PW50A	76cm Viewable (Measured diagonally)																		
Audio Output	Two Way Four Speakers Plus Woofer (10W + 10W + 12W)																			
External Speaker Connections	TX-86PW100A & TX-76PW100A 10W x Four Speakers (Not supplied)																			
Headphone Socket	TX-86PW100A & TX-76PW100A	3.5mm Stereo (Main and Sub)																		
	TX-76PW50A	3.5mm Stereo (Main)																		
Aerial Impedance	75 Ω Unbalanced coaxial																			
Component Video	TX-86PW100A & TX-76PW100A	1080i and 576P																		
	TX-76PW50A	576P																		
Video / Audio Terminals	AV1 IN (Rear)	: S-Video, Video, Audio L/R Terminals																		
	AV2 IN (Rear)	: Video or Y/P _B /P _R , Audio L/R Terminals																		
	AV3 IN (Front)	: S-Video, Video, Audio L/R Terminals																		
	AV4 IN (Rear)	: Video or Y/P _B /P _R , Audio L/R Terminals																		
Digital Audio input	TX-86PW100A & TX-76PW100A coaxial, optical																			
Video / Audio Input	S-Video	Y: 1.0Vp-p 75 Ω	C: 0.3Vp-p 75 Ω																	
	Video in	1.0Vp-p, 75 Ω																		
	Audio in	Approx. 400mV 1k Ω																		
Monitor Out	Video Out	1.0Vp-p, 75 Ω	Audio Out	Approx. 400mV 1k Ω																
Accessories Supplied	Remote Control EUR511229 2 Type 'AA' Batteries Instruction Manual TQB4A0152																			
Dimensions		w	d	h	Weight															
	TX-86PW100A	92.6cm	65.1cm	58.4cm	86kg															
	TX-76PW100A & TX-76PW50A	82.7cm	53.5cm	57.9cm	60kg															

Note:

Design and Specifications are subject to change without notice. Weight and Dimensions shown are approximate.

Customer's Record

The serial number of this product can be found on its rear cover and on the carton. It is recommended that you note the serial number and other details in the space provided and retain this booklet in a safe place as a permanent record of your purchase to aid in identification in the event of theft or loss.

Model No. _____

Serial No. PA - _____

Purchase Date _____

Purchased From _____

AUSTRALIA



NEW ZEALAND

**Distributed in New Zealand by
Panasonic New Zealand Limited**
350 Te Irirangi Drive
East Tamaki, Auckland
Customer Care Center
Ph: 0800 726 276
Email: Customerservice@panasonicnz.co.nz
www.panasonic.co.nz



Matsushita Electric Co. (Aust) Pty Ltd
P.O. Box 326 Penrith NSW 2751
ABN: 25 000 611 389
Certified to International Quality Standard AS/NZS ISO9001
Certified to International Environmental Standard ISO14001

