

Box 2

# Panasonic

## Operating Instructions

### Colour Television

- \* TX-28WG25 series
- TX-32WG25 series

This is a combined Operating Instruction manual for all the above series of models.

Please read these instructions before operating your set and retain them for future reference.

## *Dear Panasonic Customer*

*Welcome to the Panasonic family of Customers. We hope that you will have many years of enjoyment from your new colour television set.*

*To obtain maximum benefit from your set, please read these Instructions before making any adjustments, and retain them for future reference.*

*Retain your purchase receipt also, and note down the Serial Number of your set in the space provided on the rear cover of these Instructions.*

### **AR/AS Coating on the Screen**

The Picture Tube Screen is coated with a special material to hinder ambient light reflection and dust adherence. It aids picture performance during high ambient light conditions. The AR/AS coating may be observed when the set is switched off, since the coating give the screen surface a faint purplish or blue hue. Take care not to mark or scratch this coating.



Connect the Aerial Cable to the RF in Terminal .....	6
Connecting 3D Woofer Speakers .....	7
Connect the Plug to the wall outlet .....	7
How to Turn the Power On .....	7
Battery Installation .....	8
Geomagnetism Correction .....	9

Channel Selection .....	18
Country System Selection .....	20
Automatic Tune .....	22
Manual Tune .....	24
Fine Tuning .....	26
How to Cancel the Fine Tuning Function .....	27
Programme Number Skip .....	28
How to Cancel the Skip Function .....	29

How to switch the power ON or OFF/Stand-By Mode .....	30
Programme Number Selection .....	30
Direct Programme Number Selection .....	30
TV/AV Mode Selection .....	30
Volume Adjustment .....	31
Display Button .....	31
Mute Button .....	31
GAME Button .....	31
Recall Button .....	31
Off Timer Button .....	31
Sound System Selection .....	32
Colour System Selection .....	33

Manual ASPECT Operation .....	34
Multi Window Operation .....	36
SELF ASPECT Operation .....	38
STROBE Operation .....	39
Picture in Picture Operation .....	40
Stereo Reception .....	42
Surround Operation .....	44
Picture Menu Operation .....	45
Sound Menu Operation .....	46
Main Menu Operation .....	48
Main Menu Operation (Aspect, Picture, Sound) .....	49
Features Menu Operation (BLUE BACK, VCR/GAME, P•DE) .....	50
Features Menu Operation (GAME, SELF ASPECT, SIDE BAND) .....	51

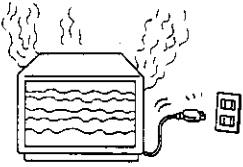
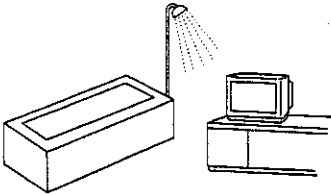

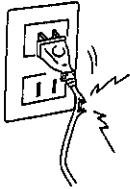
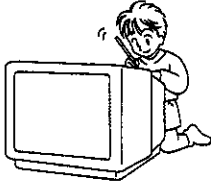
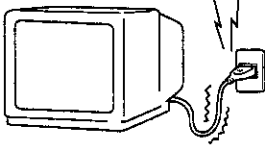
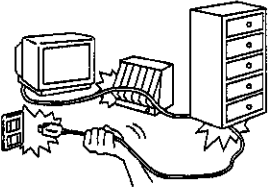
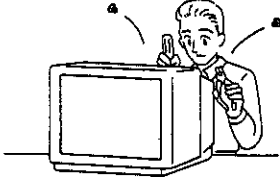
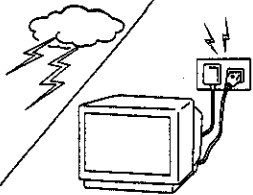
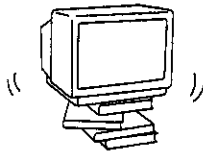
## Warnings

	<p>Unplug the power cord in the event of any malfunction (screen goes blank, no sound, odd sounds, smoke or unusual odors coming from the unit). Unplug the power cord if foreign matter or water falls into the unit, or if the unit is dropped or the cabinet is damaged.</p>		<p>DO NOT use this unit near water. (near a bath tub, etc.)</p>
	<p>DO NOT place any of the following on the unit: Flower vases, flower pots, cups, small metal objects, or cosmetics containers, chemicals or water.</p>		<p>DO NOT use if the power cord or power plug is damaged, or if the plug does not fit tightly into the socket.</p>
	<p>DO NOT insert foreign objects (metal or easily flammable objects).</p>		<p>DO NOT use at a voltage other than indicated.</p>
	<p>TAKE CARE NOT to damage the power cord.</p>		<p>DO NOT remove the rear cover as live parts and High Voltage components are accessible when the rear cover is removed.</p>
	<p>DO NOT touch the aerial cable and this unit when there is lighting.</p>		<p>DO NOT place in an unstable location.</p>

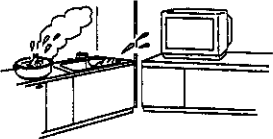
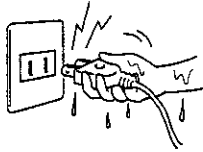

## Cautions

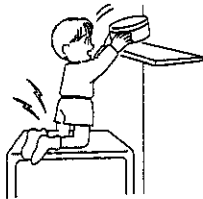
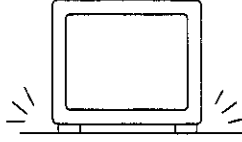
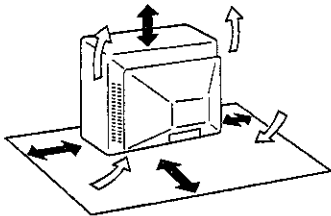
	<p>DO NOT place in humid or dusty locations, or areas exposed to smoke or steam.</p>		<p>DO NOT touch the power plug if your hands are wet.</p>
---	--	--	---

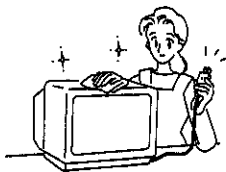
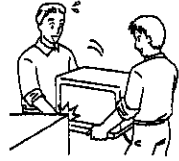
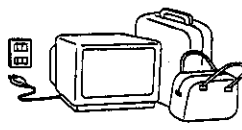
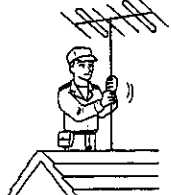
## Cautions

	<p>DO NOT stand, or place heavy objects on the unit. Particular care should be taken by families with small children.</p>		<p>Place in a safe location.</p>
	<p>Adequate ventilation is essential to prevent failure of electrical components, we recommend that a gap of at least 10cm ( <math>\longleftrightarrow</math> ) is left all around this unit even when it is placed inside a cabinet or between shelves.</p>		<p>Turn the power "Off" before connecting other electrical equipment.</p>
	<p>Before cleaning, unplug the power plug from the socket.</p>		<p>DO NOT jolt the unit.</p>
	<p>Unplug the power plug from the socket if you are not going to use the unit for an extended period.</p>		<p>Ask your sales outlet to install the aerial.</p>

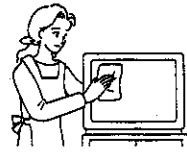
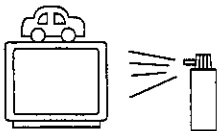
## Cleaning

	<p>The unit contains many plastic parts. For this reason DO NOT use benzine, thinner or other chemicals to clean the unit.</p>		<p>Dust will accumulate on the picture screen. Please wipe with a soft cloth from time to time. If you use a chemically treated cloth, please be careful to follow the instructions that come with the cloth.</p>
	<p>DO NOT bring into contact with insecticide or other volatile substances. DO NOT allow the unit to come into contact for extended periods with rubber or vinyl products.</p>		<p>Remove dirt and soiling by wiping with a light cloth. Even if the unit is heavily soiled, do not apply cleaner directly to the unit. Soak a cloth in a solution of neutral cleanser thinned with water. Then wring out the cloth, wipe the unit clean, and finish by wiping with a dry cloth.</p>

## Connect the Aerial Cable to the RF in Terminal

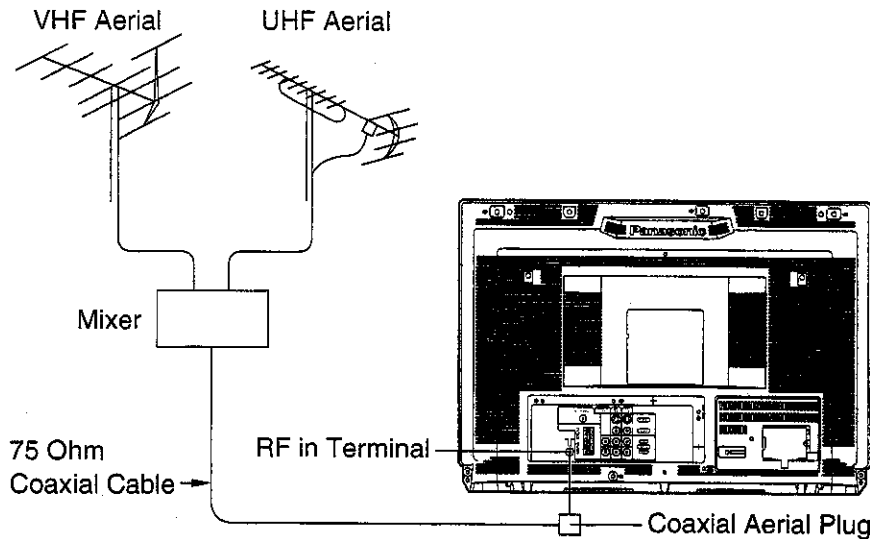

To obtain optimum quality picture and sound, an Aerial, the correct cable (75 Ohm coaxial) and the correct terminating plug are required.

If a communal Aerial system is used, you may require the correct connection cable and plug between the wall Aerial socket and your television receiver.

Your local Television Service Centre or Dealer may be able to assist you in obtaining the correct Aerial system for your particular area and accessories required.

Any matters regarding Aerial installation, upgrading of existing systems or accessories required, and the costs incurred, are the responsibility of you, the Customer.

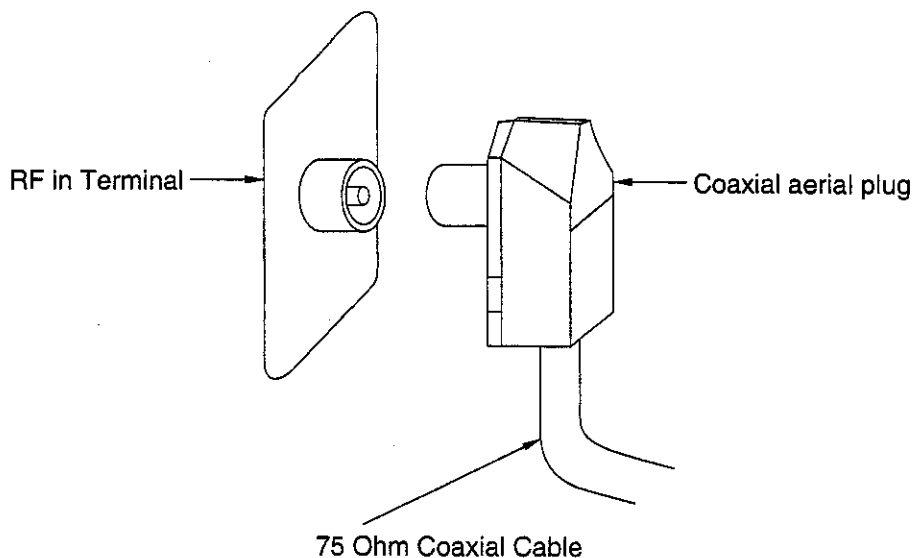

## Connecting 3D Woofer Speakers

Connect the 3D woofer speaker as follows.

When a 3D woofer speaker plug is inserted into the 3D woofer terminal.

1. Fix the 3D woofer speaker to the position as shown below.

2. Insert the 3D woofer speaker plug into the 3D woofer terminal.

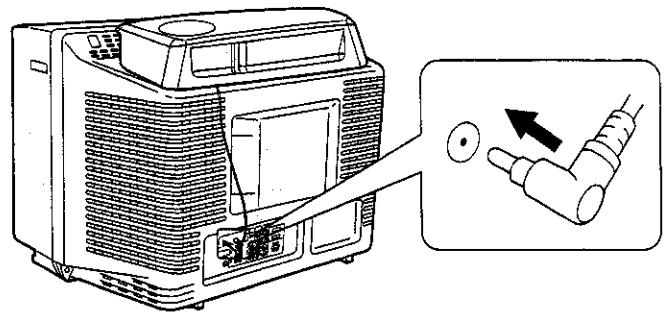
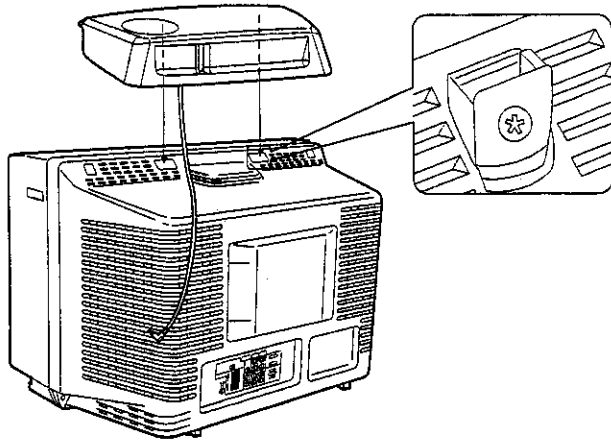

## Connect the Plug to the Wall Outlet

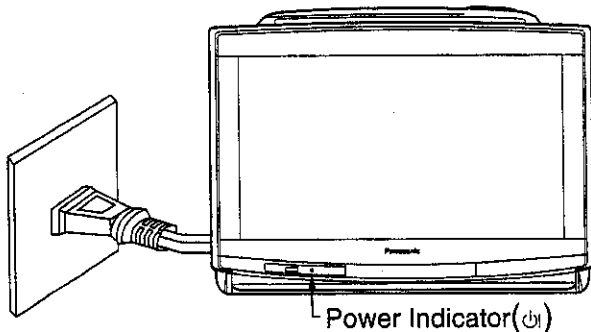

### Note:

Mains plug types vary between countries. The mains plug shown at left may therefore not be the type fitted to your set.

When connecting the mains plug to the wall outlet, the power indicator will light (Orange).

## How to Turn the Power On

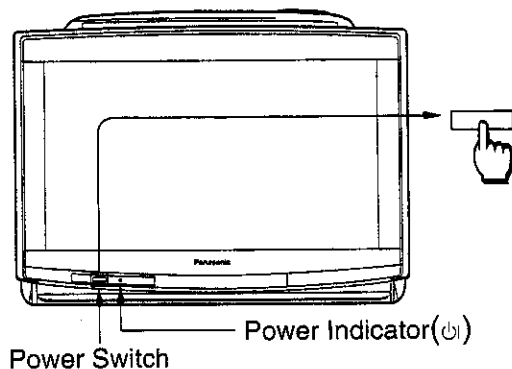

Push the Power Switch on the Television to turn the set on.

The Power Indicator will light.

Power-OFF ..... Orange

Stand-by ⓘ ..... Red

Power-ON ..... Green

### Note:

When in the Stand-by condition (Refer to page 30), it is possible to turn the TV set on by pushing the "Power (Stand-by)" Button or the "Direct Programme Number Selection" Buttons (0-9), Programme Number Up and Down Buttons either on the TV set or Remote Control.

## Battery Installation

1

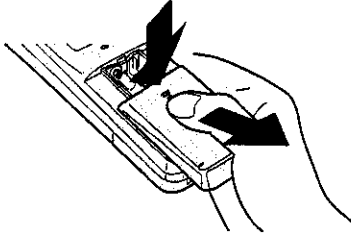

### Open the cover.

Apply slight downward pressure while pulling towards the bottom.

2

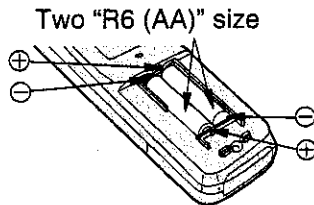

### Batteries: Use two "R6 (AA)" size batteries.

Insert the batteries ensuring correct polarity. This is identifiable by the "+" and "-" symbols on both the batteries and inside the battery compartment.

3

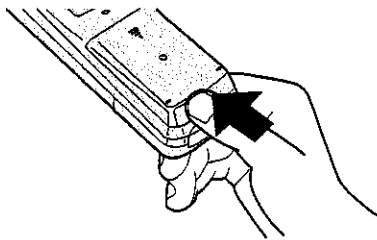

### Replace the cover.

Do not use rechargeable (Ni-Cd) batteries. They are different in shape and performance and may fail to ensure correct operation.

## Battery cautions

The incorrect use of batteries can cause electrolyte leakage which will corrode the Remote Control or cause the batteries to burst.

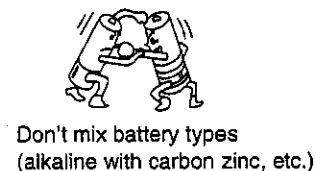
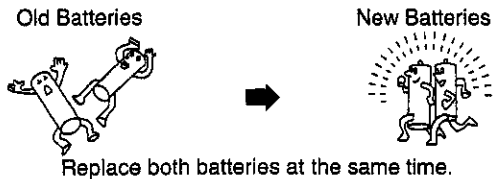





## Geomagnetism Correction

Since a large picture tube has been used, blurring of colours and patches strange colouration may occur depending on the direction the television faces. This is caused by a geomagnetic effect. For optimum viewing, it is necessary to adjust the TV placement.

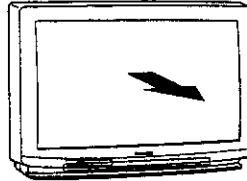
- 1** The Power should be off when determining the installation location and direction.  
At this time please verify what direction the TV screen is to face (direction indicated by the arrow).



- 2**  Push the "Main Power Switch".

- 3**  Push the "Main Menu" Button.

ASPECT  
PICTURE  
SOUND  
FEATURES  
PRESET  
LANGUAGE  
ENGLISH  
中国語

"Main Menu" Condition.

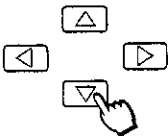
- 4**  Select the Feature Menu by using the Position Up "▲" or Down "▼" Button.

ASPECT  
PICTURE  
SOUND  
FEATURES  
PRESET  
LANGUAGE  
ENGLISH  
中国語

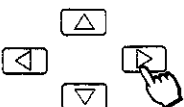
- 5**  Push the Position Left "<" or Right ">" Button.

BLUE BACK OFF  
VCR/GAME OFF  
P · DE ON  
GAME MODE AV2  
SELF ASPECT JUST  
SIDE BAND LIGHT 1  
GEOMAGNETIC 4

"Features Menu" Condition.

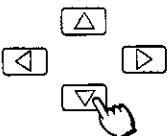
- 6**  Select the Geomagnetic Mode by using the Position Up "▲" or Down "▼" Button.

BLUE BACK OFF  
VCR/GAME OFF  
P · DE ON  
GAME MODE AV2  
SELF ASPECT JUST  
SIDE BAND LIGHT 1  
GEOMAGNETIC 4

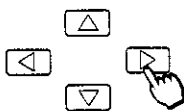
- 7**  Adjust the placement so that the coloured patches in the four corners of the screen do not appear.

BLUE BACK OFF  
VCR/GAME OFF  
P · DE ON  
GAME MODE AV2  
SELF ASPECT JUST  
SIDE BAND LIGHT 1  
GEOMAGNETIC 5

### Helpful Hint

- (1) If geomagnetic changes still cause colour patches on the screen even after the TV is installed, turn the power off and turn back on again after about 30 minutes.
- (2) Adjustment for geomagnetism should be performed every time the location of the TV is changed.
- (3) In some cases colour patches will not be completely eliminated even after adjustment, particularly in ferro-concrete buildings and other structures susceptible to geomagnetism. In these cases adjust by changing the installation location.

# Controls and Terminals on the TV

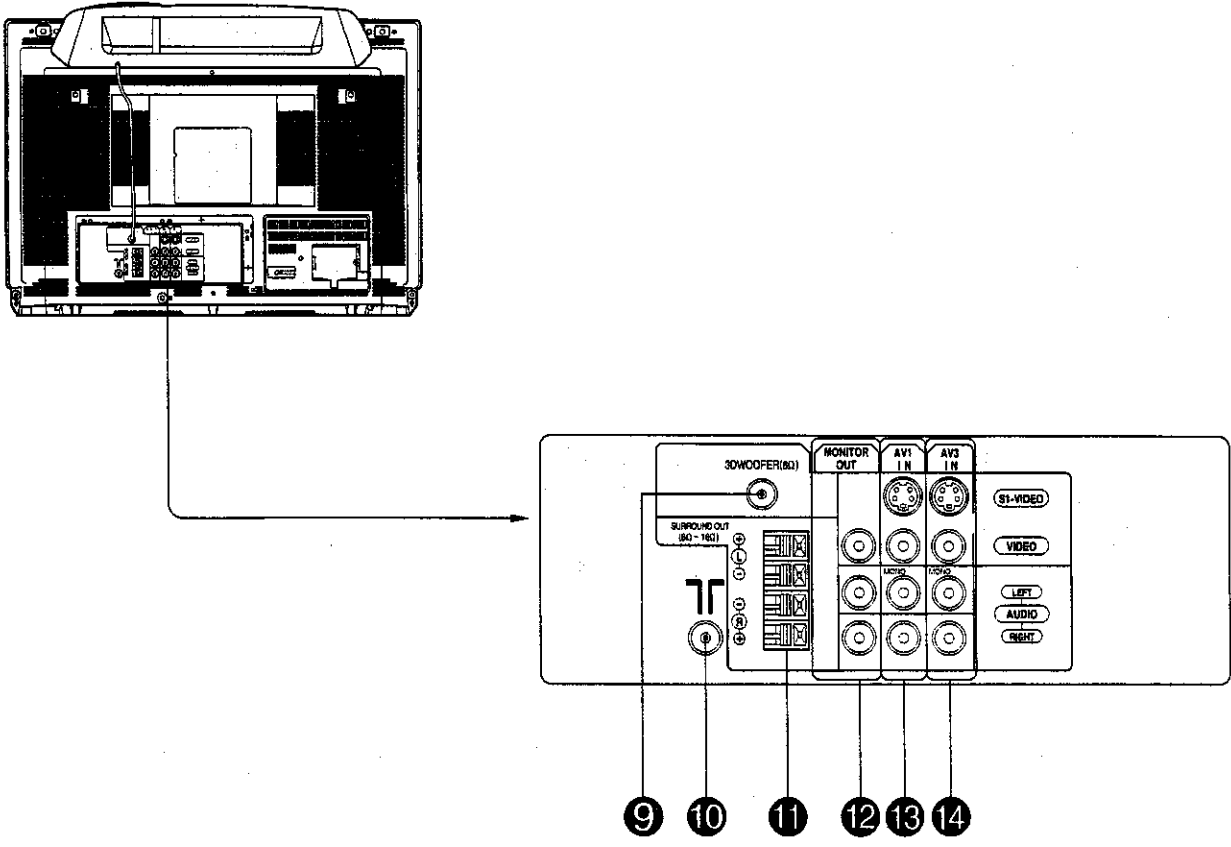
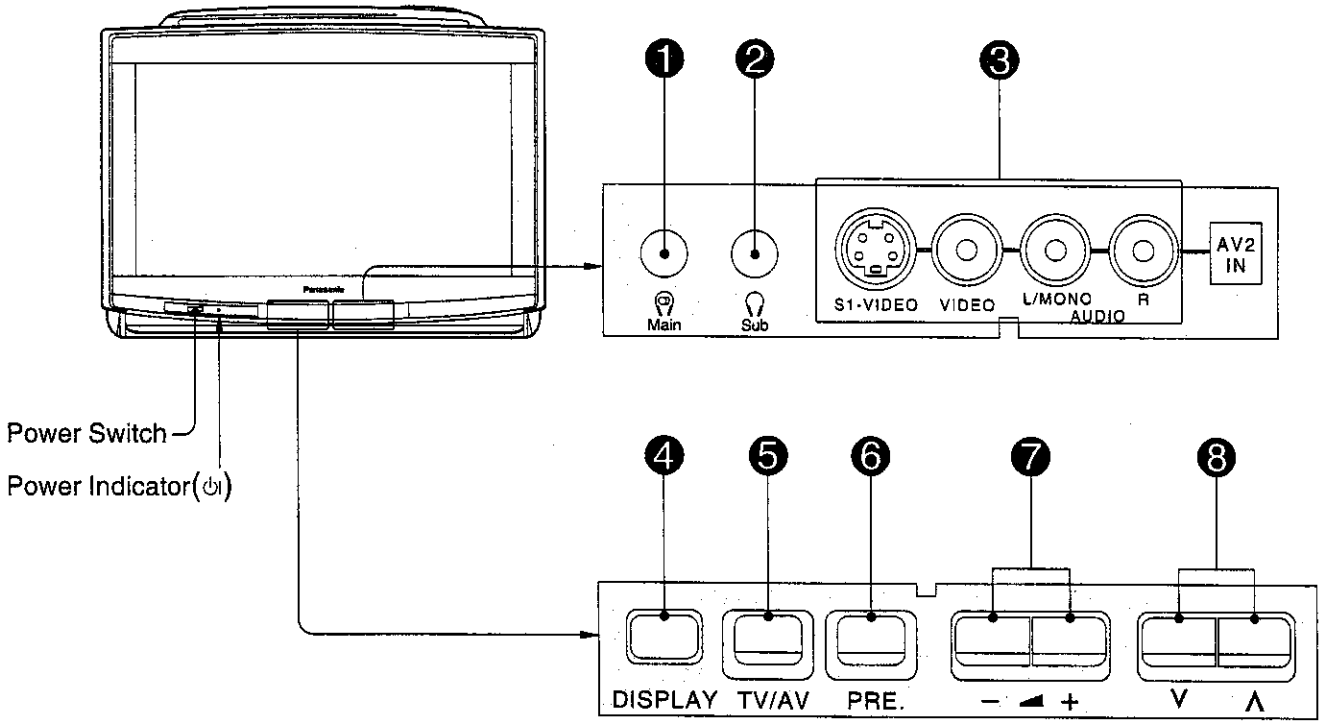

---

Item No.	Description/Function	Refer to Page(s)
----------	----------------------	------------------

---

1	Main Headphones Jack	16
2	Sub Headphones Jack	16
3	AV2 Input Terminals	14
4	Display	31
5	TV/AV Selection	30
6	Preset	19, 20, 22
7	Volume Up (+) and Down (-)	31
8	Programme Number Up (^) and Down (v)	30
9	3D Woofer Speaker Terminal	7
10	Aerial Terminal (Also called the "RF In Terminal")	6
11	Surround Speaker Terminals	15
12	Monitor Output Terminals	15
13	AV1 Input Terminals	14
14	AV3 Input Terminals	14

# Remote Control

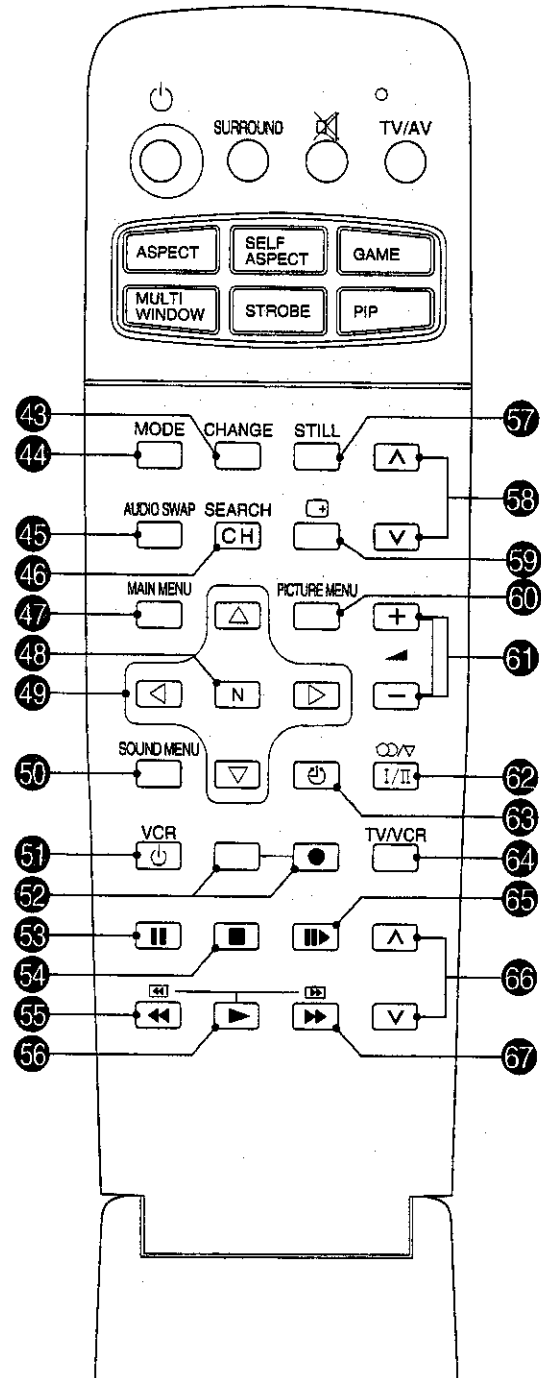
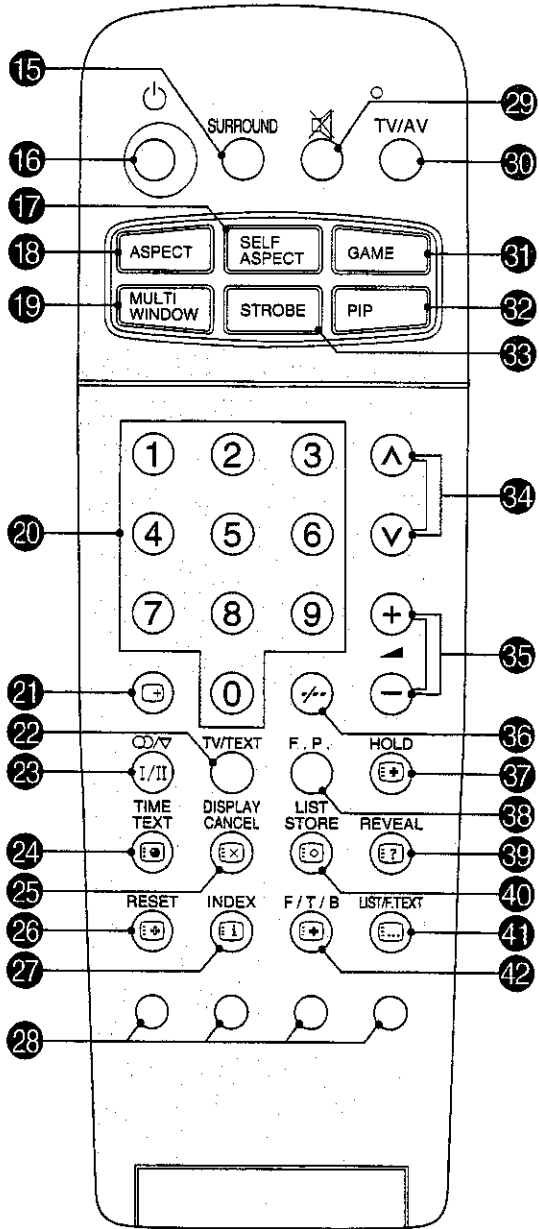

Item No.	Function	Refer to Page	Item No.	Function	Refer to Page(s)
15	Surround Selection	44	43	Main/Sub picture Change	36, 40
16	Power (Stand-by)	30	44	Sub picture TV/AV Mode Selection	37, 40
17	SELF ASPECT	38	45	Audio Swap	37, 41
18	ASPECT	34	46	Sub picture Channel Search	37, 41
19	MULTI WINDOW	36	47	Main Menu Selection	48
20	Direct Programme Number Selection	30	48	Normalisation	48
21	Status Recall	31	49	Position Buttons	48
22	TV/TEXT Selection	53	50	Sound Menu Selection	46
23	Stereo/Bilingual Sound Selection	42	51	VCR Power	56
24	Time Text	55	52	VCR Record	56
25	TEXT Display Cancel	54	53	VCR Pause Still	56
26	TEXT Reset	53	54	VCR Stop	56
27	TEXT Index	53	55	VCR Rewind/Review	56
28	TEXT Colour-coded Buttons	53	56	VCR Play	56
29	Sound Mute	31	57	Still	37, 41
30	TV/AV Mode Selection	30	58	Programme Number Up and Down Buttons for Sub picture	37, 41
31	GAME	31	59	Recall	31
32	Picture in Picture Selection	40	60	Picture Menu Selection	45
33	STROBE	39	61	Volume Up and Down	31
34	Programme Number Up and Down	30	62	Stereo/Bilingual Sound Selection	42
35	Volume Up and Down	31	63	OFF Timer Selection	31
36	Two Digit Programme Number Selection	30	64	TV/VCR Mode Selection	56
37	TEXT Hold	53	65	VCR Still/Advance	56
38	TEXT Favourite Page Selection	53	66	VCR Programme Number Up and Down Buttons	56
39	TEXT Reveal	53	67	VCR Fast Forward /Cue	56
40	TEXT List Store	53			
41	TEXT LIST/F. TEXT	53			
42	TEXT Full/Top/Bottom Selection	53			

## How to connect the "AV1, 2 or 3" Input Terminals.

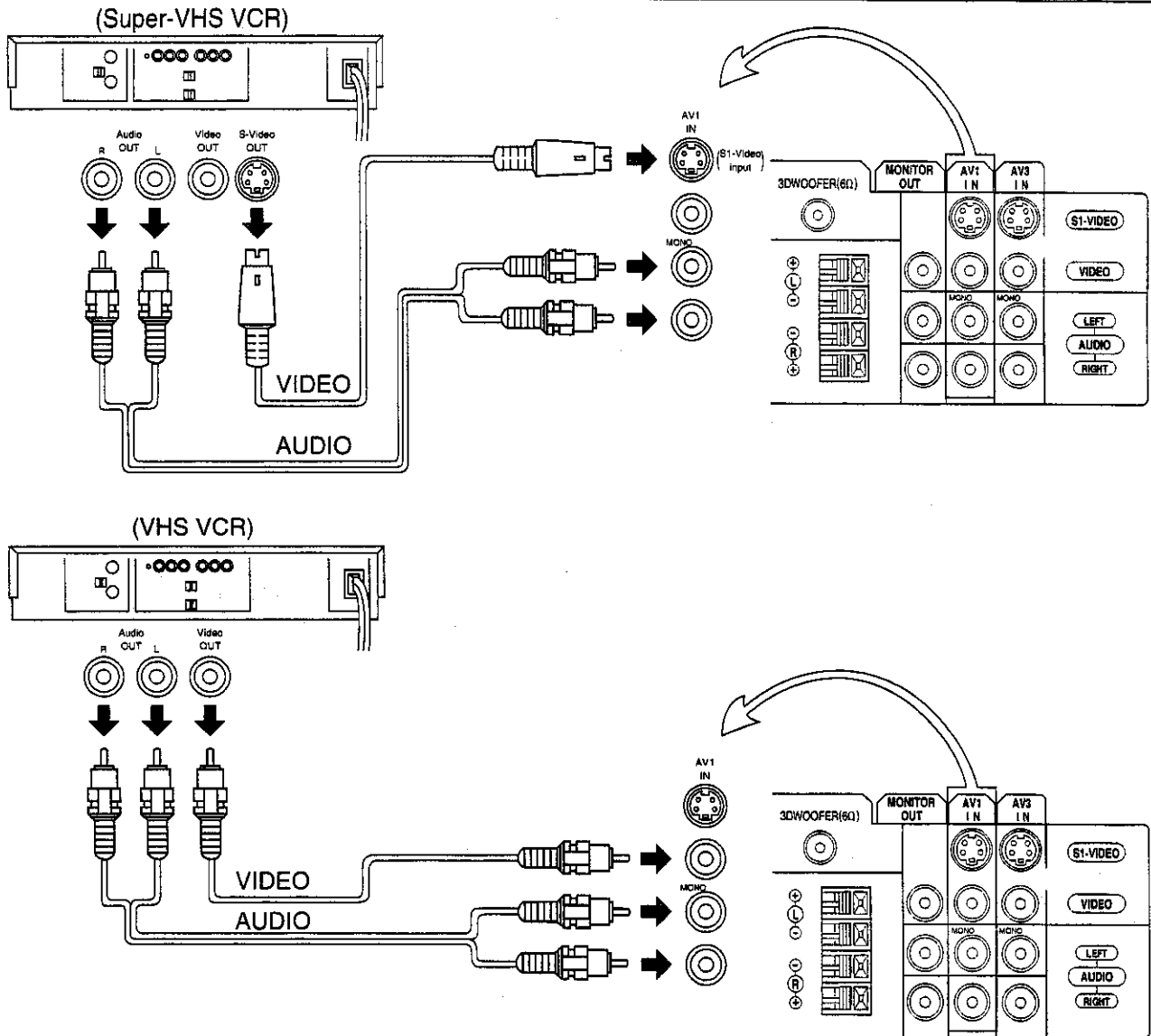

### Note:

- (1) When AV1, AV2 or AV3 is selected, and that AV mode has no input picture signal, the Background Colour of the TV screen will change. (This only occurs if the Blue-Back function is set to the ON condition; refer to page 50 for details.)
- (2) When an S-Video cable is connected to the S1-Video terminal, the Phono Video input will be automatically switched off for that AV mode.
- (3) When a Monaural VCR is used, connect the Monaural Audio cable to the Audio "LEFT" terminal.
- (4) Similar connections are available at the AV1, AV2 and AV3 input terminals.  
Select the desired AV input position by pushing the TV/AV Mode button. (Refer to page 30)

### S(Separator)1-Video Terminal

The S1-Video terminal on this unit is a separator luminance (Y) and chrominance (C) signal terminal which supports videos compatible with wide TV. When a full image from the S1 Video terminal of special video is detected by the unit, the screen size automatically sets to full. Connection is established with priority given to the S1-video when the S1-video input terminal and the video input terminal are connected at the same time. Thus connection is not required for video input. Also, when connecting, connect the audio mode at the same time.

## How to connect the AV MONITOR OUTPUT terminals to other equipment.

The MONITOR OUT terminals output the same signals as main picture on the TV screen and sound from the speakers at that time, e.g. TV programmes or signals from AV1, AV2 or AV3 input.

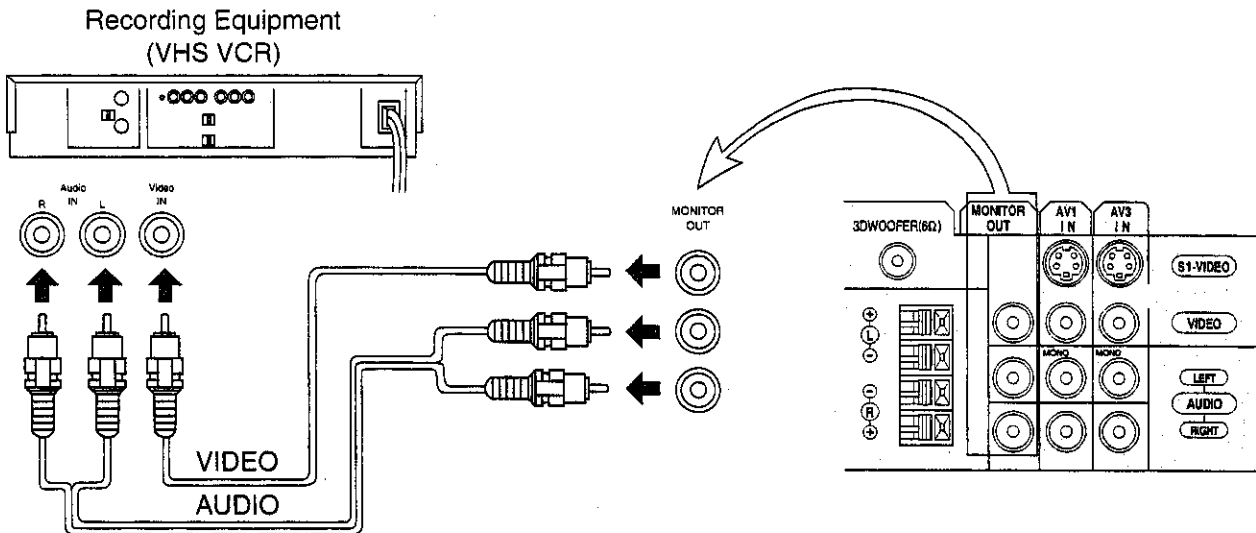

### Note:

- (1) Never connect the same video recorder with both the VIDEO IN and MONITOR OUT terminals on this TV set, as this could cause incorrect operation.
- (2) The monitor output emits the main picture normal video and audio signals.
- (3) Teletext displays on screen will not be output at the MONITOR OUT terminals.
- (4) Even if the television in multi window condition, MONITOR OUT terminals output the same signals as main picture on the screen and sound from speakers. Sub picture including strobe, still, channel search, etc. will not be output at the MONITOR OUT terminals.

## Connecting Surround Speakers

Connect the surround speakers as follows.

The Surround effect is enhanced by connecting external surround speakers. (optional)

Although it is possible to enjoy the "Surround effect" with this TV set as it is, upon connecting separate "Surround Speakers" the presence of the enveloping sound becomes more vivid.

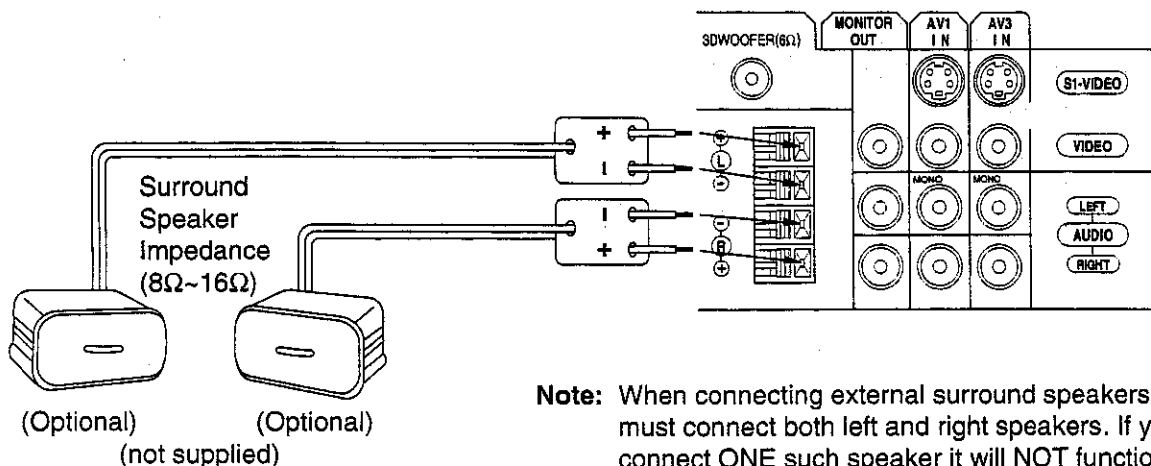

**Note:** When connecting external surround speakers, you must connect both left and right speakers. If you only connect ONE such speaker it will NOT function.

## Connecting Headphones

Connect headphones as follows.

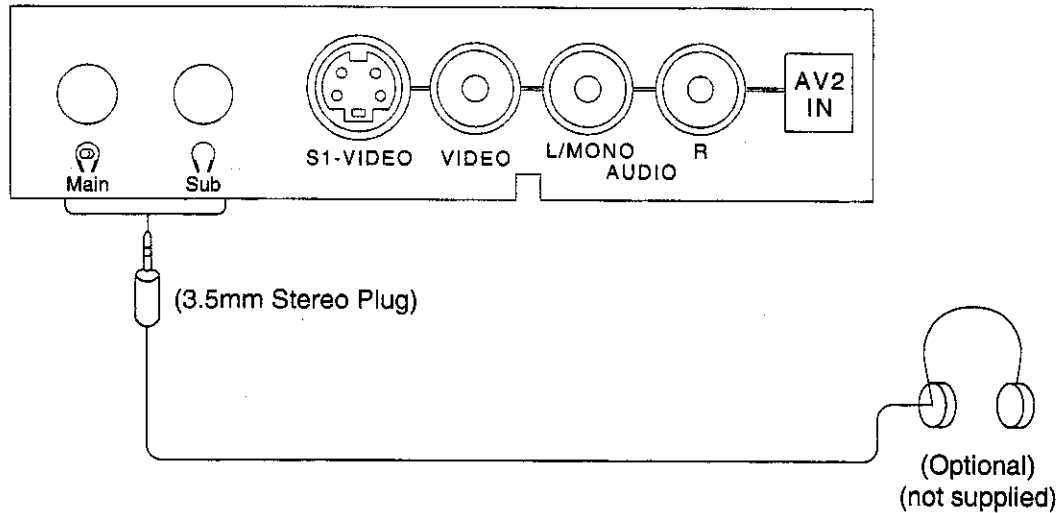

You can listen to sound from each of the headphone plugs as shown below.

Screen condition	Speaker Sound	Main Headphones	Sub Headphones	Monitor Output
Single picture/ Teletext	A	A (Stereo)	A (Mono)	A (Stereo)
Two Window/ Picture in Picture/ Picture out Picture	A B    A B    A B	A (Stereo)	B (Mono)	A (Stereo)
Two Window/ Picture in Picture/ Picture out Picture CHANGE	B A    B A    B A	B (Stereo)	A (Mono)	B (Stereo)
Two Window/ Picture in Picture/ Picture out Picture AUDIO SWAP	A B    A B    A B	B (Stereo)	B (Mono)	A (Mono)

### Main Headphones plug:

When a Main Headphones plug is inserted into the Headphones socket all speakers will be automatically disconnected; only the Main Headphones will function.

Use Volume Up "+" or Down "-" Button to control volume level.

### Sub Headphones plug:

For the volume control, refer to page 49.



Languages display on-screen can be selected by following method.

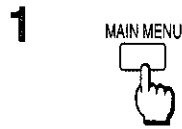
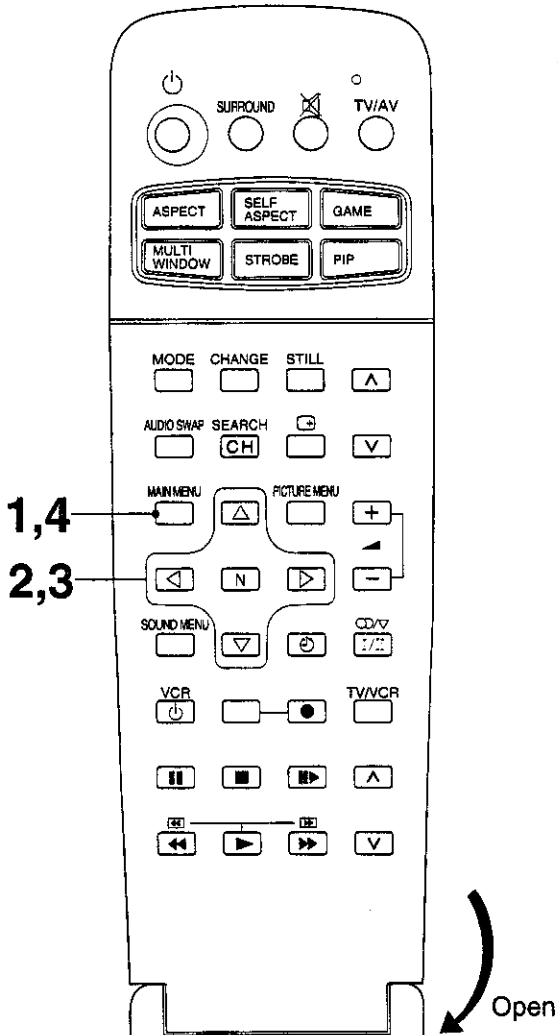

Push the "MAIN MENU" Button.

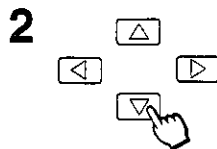
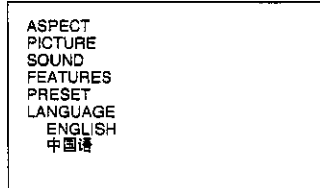

Push the "Position Up or Down" Button until your desired language position is reached.

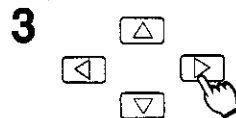
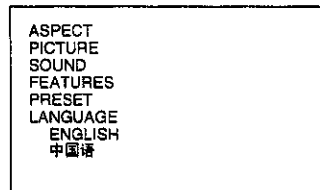

Push the "Position Left or Right" Button. The on-screen language display will change.

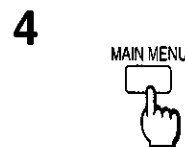
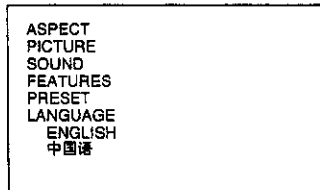

Push the "MAIN MENU" Button again to return to the normal viewing condition.

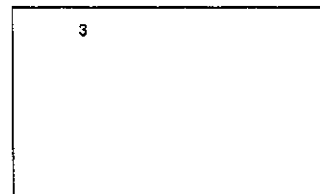

# Channel Selection

Select the most easily viewed channel selection method.

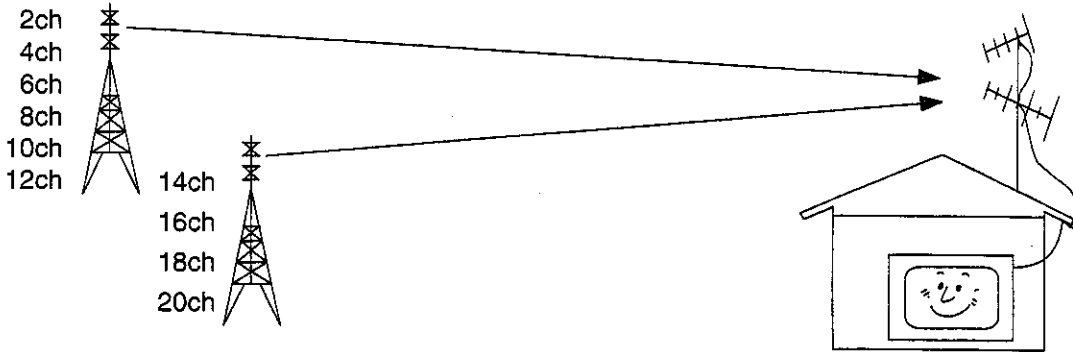

## Example

Programme Number	Channel Display	Received Channel
1	2	2
2	4	4
3	6	6
4	8	8
5	10	10
6	12	12
7	14	14
8	16	16
9	18	18
10	20	20

## POSITION SELECT

When the Channel Selection is on POS. (Position), and Auto Search is performed, the unit memories the channels searched in order from Programme No.1.

- Push the button ① to view channel 2.
- Push the button ② to view channel 4.
- Push the button ③ to view channel 6.

During Position mode various reception channels can be viewed.

## Example

Programme Number	Channel Display	Received Channel
1	-	-
2	2	2
3	-	-
4	4	4
5	-	-
6	6	6
7	-	-
8	8	8
9	-	-
10	10	10
⋮	⋮	⋮
20	20	20
⋮	⋮	⋮

## DIRECT SELECT

When the Channel Selection is on DIRECT, and Auto Search is performed, the unit memories the programme number which is the same as the channel searched.

This method allows you to select the desired channel by pushing the channel display number directly on the remote control to select the station. The channel display numbers for the broadcast stations in each country are listed on Page 21.

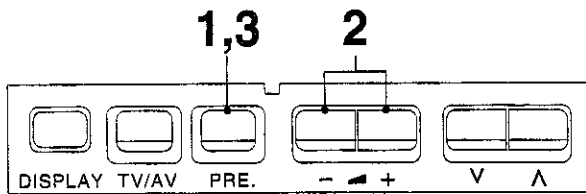

(TV set)

(Remote Control)

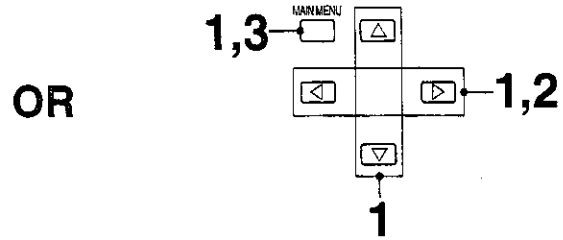

Before Country System Selection and AUTO SEARCH tuning, set the "CHANNEL SELECT" mode, as detailed below.

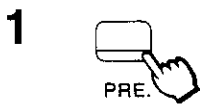

1 Push the "PRE." (PRESET) Button, setting the Preset Menu to "CH SELECT".

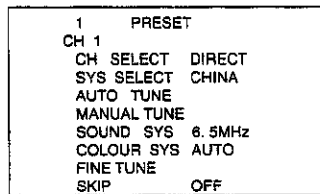

"CH SELECT" Condition.

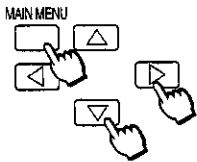

Push the "MAIN MENU" and "Position" Buttons, until the Preset Menu to "CH SELECT".

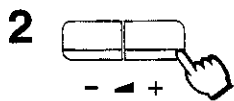

2 Select the "CH SELECT (Channel Select)" Mode by pushing the Volume Up "+" or Down "-" Button.

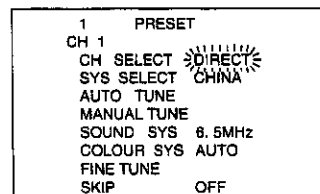

Setting range when the "POS." (Position) has been selected: Position 0-99

Setting range when the "DIRECT" has been selected: Channel 1-125

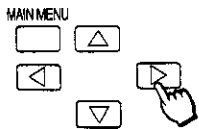

Select the "CH SELECT (Channel Select)" Mode by pushing the Position Left "<" or Right ">" Button.

The channel select indicator will change as follows.

DIRECT ↔ POS.



3 Push the "PRE." (PRESET) Button 8 times.

This returns the set to the normal viewing condition.



Push the "MAIN MENU" Button twice.

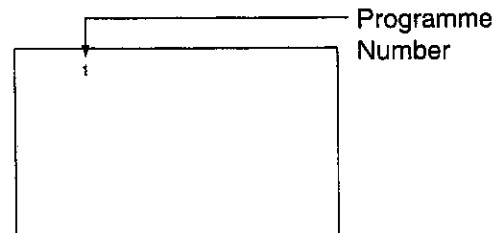

# Country System Selection

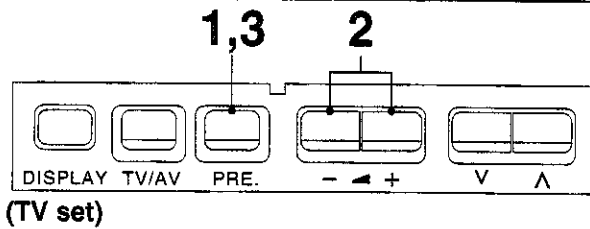

OR

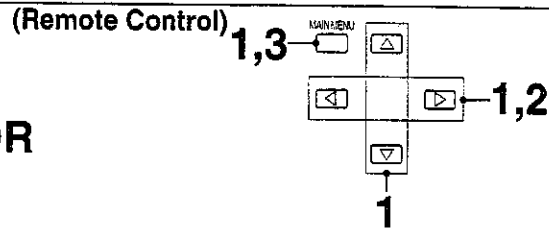

Before AUTO SEARCH tuning and MANUAL SEARCH tuning, set the "SYSTEM SELECT" mode, as detailed below.

- 1** Push the "PRE." (PRESET) Button twice, setting the Preset Menu to "SYS SELECT".
- Push the "MAIN MENU" and "Position" Buttons, until the Preset Menu to "SYS SELECT".

1	PRESET
CH 1	
CH SELECT	DIRECT
SYS SELECT	CHINA
AUTO TUNE	
MANUAL TUNE	
SOUND SYS	6.5MHz
COLOUR SYS	AUTO
FINE TUNE	
SKIP	OFF

"SYS SELECT" Condition.

- 2** Select the appropriate System by pushing the Volume Up "+" or Down "-" Button.
- Select the appropriate System by pushing the Position Left "<" or Right ">" Button.

1	PRESET
CH 1	
CH SELECT	DIRECT
SYS SELECT	CHINA
AUTO TUNE	
MANUAL TUNE	
SOUND SYS	6.5MHz
COLOUR SYS	AUTO
FINE TUNE	
SKIP	OFF

The system select indicator will change as follows.

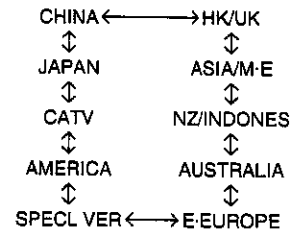

- 3** Push the "PRE." (PRESET) Button 7 times.
- Push the "MAIN MENU" Button twice.

1	
---	--

This returns the set to the normal viewing condition.

## System Select by Country

SYSTEM SELECT	COUNTRY
CHINA	China
HK/UK	Hong Kong, United Kingdom
ASIA/M•E	Malaysia, Singapore, Thailand, Asia countries, Kuwait, Saudi Arabia, United Arab Emirates, Middle East countries, etc.
NZ/INDONES	New Zealand, Indonesia, etc.
AUSTRALIA	Australia
E•EUROPE	CIS, Poland, etc.
SPECL VER	South Africa
AMERICA	U.S.A., Chile, Mexico, Panama, Peru, Philippines, Taiwan, Venezuela, etc.
CATV	USA CATV
JAPAN	Japan

## Channel Allocation

- CATV (USA CATV) channel numbers as recommended by the joint EIA/NCTA Engineering committee and published as EIA INTERIM STANDARD No.6-CABLE TELEVISION CHANNEL IDENTIFICATION PLAN-MAY 1983.
- The receiving channels are as follows;

SYS SELECT	CHINA	HK/UK	ASIA/M•E	NZ/INDONES	AUSTRALIA	E•EUROPE	SPECL VER	AMERICA	CATV	JAPAN
CH DISPLAY	RECEIVE CHANNEL									
0	-	-	-	-	0	-	-	-	-	-
1	1	-	-	1	1	1	1	-	1	1
2	2	-	2	2	2	2	2	2	2	2
11	11	-	11	11	11	11	11	11	11	11
12	12	-	12	-	12	12	12	12	12	12
13	13	-	-	-	-	-	13	13	-	13
14	-	-	-	-	-	-	-	14	-	-
20	-	-	-	-	-	-	-	-	-	-
21	-	21	21	21	-	21	21	-	-	-
28	-	-	-	-	28	-	-	-	-	-
57	57	-	-	-	-	-	-	-	-	-
58	-	-	-	-	-	-	-	-	-	-
62	-	62	62	62	62	62	62	62	62	62
63	-	63	63	63	63	63	63	63	63	C13
69	-	69	69	69	69	69	69	69	-	-
70	-	-	-	-	-	-	-	-	-	-
73	-	-	-	-	-	-	-	-	-	-
74	-	S'1	S'1	S'1	-	S'1	S'1	-	-	-
75	-	S'2	S'2	S'2	-	-	S'2	-	-	-
76	-	S'3	S'3	S'3	-	-	S'3	-	-	-
77	-	-	-	-	-	-	-	-	-	-
78	-	-	-	-	-	-	-	-	-	-
79	-	-	-	-	-	-	-	-	-	-
80	-	S1	S1	S1	-	S1	S1	-	-	-
81	Z1	S2	S2	S2	-	S2	S2	-	-	-
89	Z9	S10	S10	S10	-	S10	S10	-	-	-
90	Z10	S11	S11	S11	5A	S11	-	-	-	-
91	Z11	S12	S12	S12	9A	S12	-	-	-	-
92	Z12	S13	S13	S13	-	S13	-	-	-	-
93	Z13	S14	S14	S14	-	S14	S14	-	-	-
94	Z14	S15	S15	S15	-	S15	S15	-	-	-
95	Z15	S16	S16	S16	-	S16	S16	-	-	-
96	Z16	S17	S17	S17	-	S17	S17	-	-	-
97	Z17	S18	S18	S18	-	S18	S18	-	-	-
98	Z18	S19	S19	S19	-	S19	S19	-	-	-
99	Z19	S20	S20	S20	-	S20	S20	-	99	C49
100	Z20	S21	S21	S21	-	S21	S21	-	100	-
117	Z37	-	-	-	-	-	-	-	-	-
120	-	S41	S41	S41	-	S41	S41	-	-	-
125	-	-	-	-	-	-	-	-	125	-

# Automatic Tune (Channel Select and Country System must already be set; Refer to pages 18 to 21)

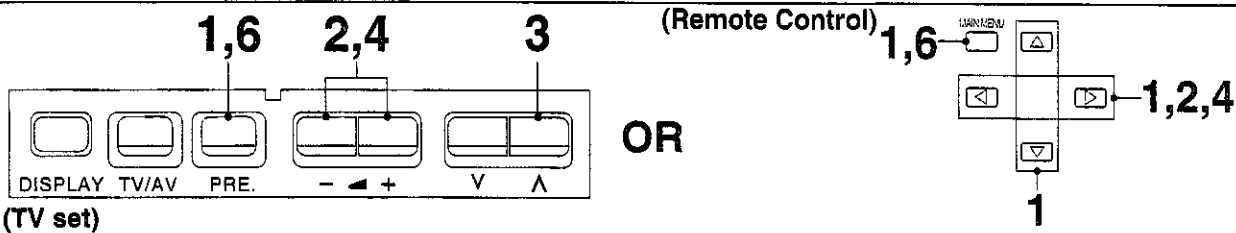

This TV uses automatic tuning to determine whether or not a broadcast signal is being sent which it can receive, and automatically prepares so that the channel selection can respond to both the position select and direct select modes.

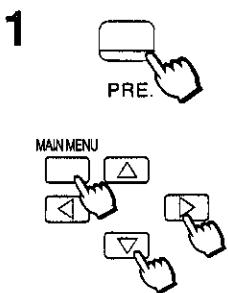

1 Push the "PRE." (PRESET) Button 3 times.

Push the "MAIN MENU" and "Position" Buttons, until the Preset Menu to "AUTO TUNE".

1	PRESET
CH 1	
CH SELECT	DIRECT
SYS SELECT	CHINA
AUTO TUNE	
MANUAL TUNE	
SOUND SYS	6.5MHz
COLOUR SYS	AUTO
FINE TUNE	
SKIP	OFF

Automatic Search "AUTO TUNE" Condition.

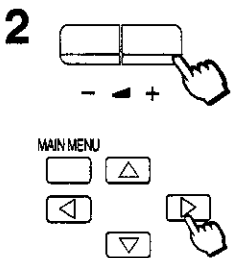

2 Push the Volume Up "+" or Down "-" Button.

Push the Position Left "<" or Right ">" Button.

1	CH 1
AUTO TUNE	
[Progress Bar]	

Search Start.

The best tuning position is automatically memorized.

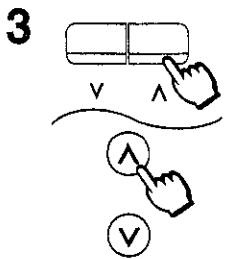

3 After all stations are tuned, the on-screen display will automatically change from "AUTO TUNE" to "SOUND SYS" Position. Confirm the sound condition of each Programme Number by using the Programme Number Up "^" Button.

2	PRESET
CH 2	
CH SELECT	DIRECT
SYS SELECT	CHINA
AUTO TUNE	
MANUAL TUNE	
SOUND SYS	8.5MHz
COLOUR SYS	AUTO
FINE TUNE	
SKIP	OFF

If the Sound is not clear or no sound is produced on a Programme Number, then follow the next Step 4.

**Note:** When sound volume is too small to confirm, turn it up by using the sound volume button on the remote control.

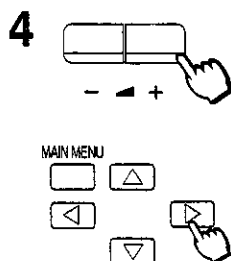

4 If necessary, push the Volume Up "+" or Down "-" Button, to improve the Sound quality.

If necessary, push the Position Left "<" or Right ">" Button to improve the Sound quality.

2	PRESET
CH 2	
CH SELECT	DIRECT
SYS SELECT	CHINA
AUTO TUNE	
MANUAL TUNE	
SOUND SYS	6.5MHz
COLOUR SYS	AUTO
FINE TUNE	
SKIP	OFF

The sound indicator will change as follows.

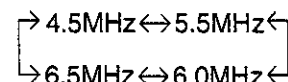

5



Use the Programme Number Up “^” button to sequentially check each station.  
If necessary, repeat step 3 to 4 for each Programme Number.

6



After all stations are tuned, push the “PRE.” (PRESET) Button 4 times.



After all stations are tuned, push the “MAIN MENU” Button twice.

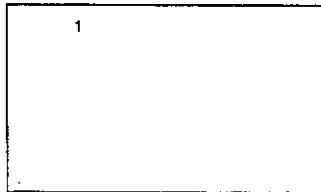

This returns the set to the normal viewing condition. Programme Number memory locations.

### Helpful Hint

- (1) If a clear picture with correct colours cannot be obtained when a Broadcast or AV signal is received, refer to the “Colour System Selection” operation on page 33.
- (2) After the Automatic Search is finished, push the Programme Number “Up” Button to confirm the tuning condition for each Programme Number. If some Programme Numbers are unused, it is possible to skip such Programme Numbers. Please refer to the Programme Number Skip operation on page 28.
- (3) Repeated pushing of the “PRE.” (PRESET) button changes the Preset Menu as follows;

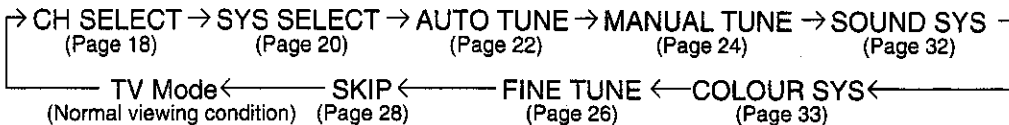

# Manual Tune

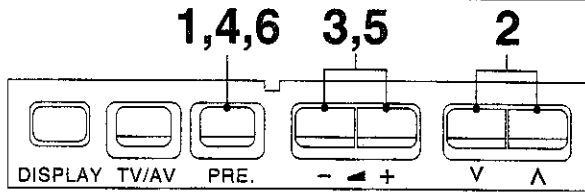

(TV set)

(Remote Control)

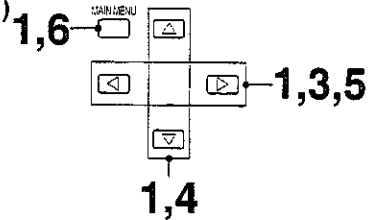

OR

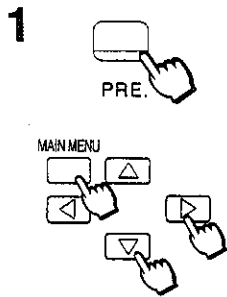

Push the "PRE." (PRESET) Button 4 times.

Push the "MAIN MENU" and "Position" Buttons, until the Preset Menu to "MANUAL TUNE".

1	PRESET
CH 1	CH SELECT DIRECT
	SYS SELECT CHINA
	AUTO TUNE
	MANUAL TUNE
	SOUND SYS 5.5MHz
	COLOUR SYS AUTO
	FINE TUNE
	SKIP OFF

Manual Search "MANUAL TUNE" Condition.

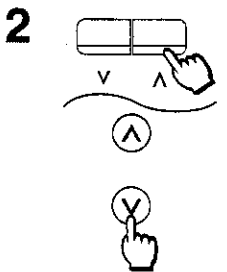

Push either the Programme Number Up "^" or Down "v" Button.

2	PRESET
CH 2	CH SELECT DIRECT
	SYS SELECT CHINA
	AUTO TUNE
	MANUAL TUNE
	SOUND SYS 5.5MHz
	COLOUR SYS AUTO
	FINE TUNE
	SKIP OFF

Select the desired Programme Number.

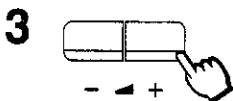

Push the Volume Up "+" or Down "-" Button.

Volume "+": Next higher Channel

Volume "-": Next lower Channel

2	PRESET
CH 2	CH 2
	MANUAL TUNE
	_____

Search Start.

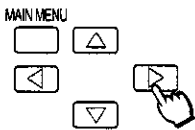

Push the Position Left "<" or Right ">" Button.

Position ">": Next higher Channel

Position "<": Next lower Channel

2	PRESET
CH 2	CH SELECT DIRECT
	SYS SELECT CHINA
	AUTO TUNE
	MANUAL TUNE
	SOUND SYS 5.5MHz
	COLOUR SYS AUTO
	FINE TUNE
	SKIP OFF

The best tuning position is automatically memorized.

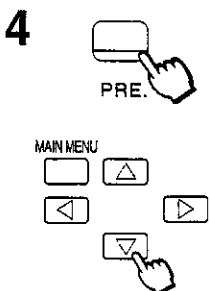

Push the "PRE." (PRESET) Button.

Push the Position Down "v" Button.

2	PRESET
CH 2	CH SELECT DIRECT
	SYS SELECT CHINA
	AUTO TUNE
	MANUAL TUNE
	SOUND SYS 5.5MHz
	COLOUR SYS AUTO
	FINE TUNE
	SKIP OFF

"SOUND SYS" Condition.



5

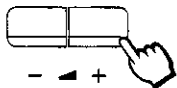

If the sound is not clear or no sound is produced on a Programme Number Position, push the Volume Up "+" or Down "-" Button.

MAIN MENU

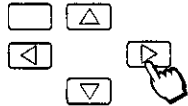

If the sound is not clear or no sound is produced on a Programme Number Position, push the Position Left "<" or Right ">" Button.

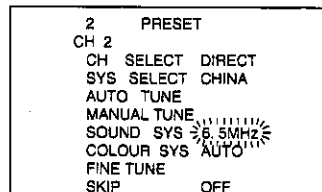

You may improve the Sound quality.

The sound indicator will change as follows.

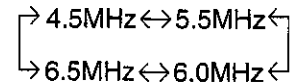

**Note:**

When sound volume is too small to confirm, turn it up by using the sound volume button on the remote control.

6



Push the "PRE." (PRESET) Button 4 times.

MAIN MENU



Push the "MAIN MENU" Button twice.

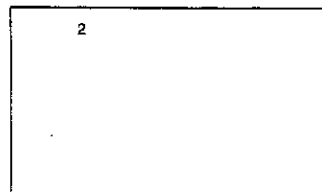

This returns the set to the normal viewing condition.

**Helpful Hint**

- (1) If a clear picture cannot be obtained even when a Broadcast or AV signal is received, refer to the "Colour System Selection" operation on page 33.
- (2) After the Manual Search is finished, push the Programme Number "Up" Button to confirm the tuning condition for each Programme Number. If Programme Numbers are unused, it is possible to skip such Programme Numbers. Please refer to the Programme Number skip operation on page 28.
- (3) When using VCR without video and audio input/output terminals for, it is convenient to connect the aerial cable as indicated in the instruction manual of VCR and to set the designated channel to programme No. "0". In that case, perform manual search after setting the colour system and sound system in advance. Further, in multi-system VCR, it is much convenient to set the designated channel to several programme Numbers.

# Fine Tuning

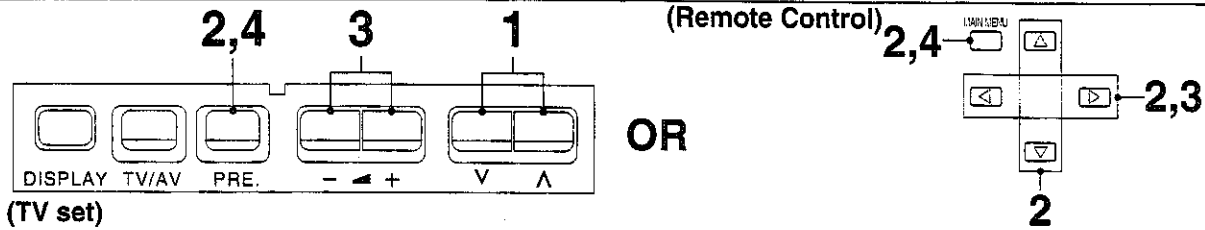

Under normal reception conditions this function is not required or necessary. However, in areas of poor reception or constant interference, a slight adjustment of the tuning may improve the picture and sound quality.

**1**

Select the channel which you want to improve, using the Programme Number Up “^” or Down “v” Button.

Select the desired Programme Number.

**2**

Push the “PRE.” (PRESET) Button 7 times, setting the Preset menu to “FINE TUNE”.

Push the “MAIN MENU” and “Position” Buttons, until the Preset Menu to “FINE TUNE”.

```

2 PRESET
CH 2
CH SELECT DIRECT
SYS SELECT CHINA
AUTO TUNE
MANUAL TUNE
SOUND SYS 5.5MHz
COLOUR SYS AUTO
FINE TUNE
SKIP OFF
    
```

Fine Tune Condition.

**3**

Push and hold the Volume Up “+” or Down “-” Button until the clear picture is received.

Push and hold the Position Left “<” or Right “>” Button, until the clear picture is received.

Fine Tune Start.

```

■ 2 PRESET
CH 2
CH SELECT DIRECT
SYS SELECT CHINA
AUTO TUNE
MANUAL TUNE
SOUND SYS 5.5MHz
COLOUR SYS AUTO
FINE TUNE
SKIP OFF
    
```

The AFC function is deactivated. The “■” symbol appears to the left of the Programme Number.

**4**

Push the “PRE.” (PRESET) Button twice.

Push the “MAIN MENU” Button twice.

This returns the set to the normal viewing condition.

# How to Cancel the Fine Tuning

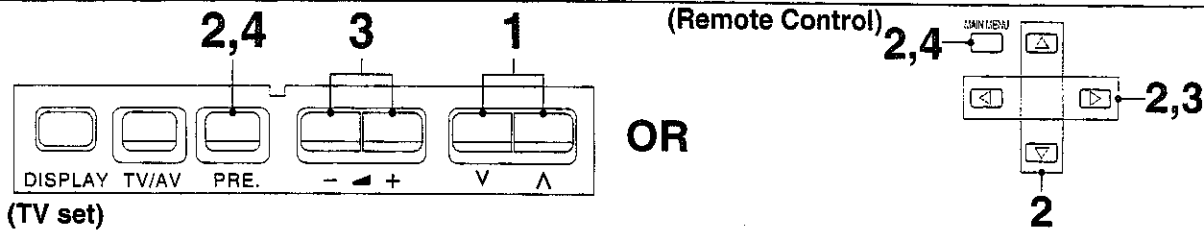

Cancelling previously adjusted (manually) fine tuning, means re-activating the AFC (Automatic Frequency Control) Function, also known as AFT (Automatic Fine Tuning). Re-activating the Automatic Fine Tuning means albamg the set to automatically tune to the optimum tuning position, for that programme Number.

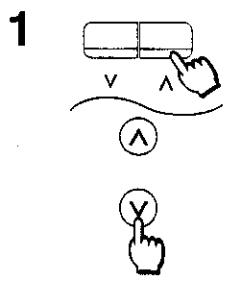

1 Select the "AFC OFF" Programme Number which you want to return to Automatic Frequency Control (cancel the manual fine tuning).

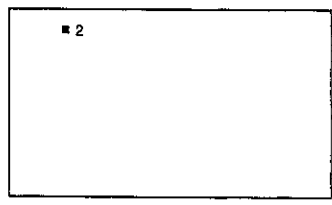

"AFC OFF" Programme Numbers are indicated to you by the "■" symbol to the left of the Programme Numbers in the On-Screen Display.

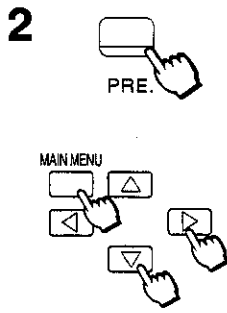

2 Push the "PRE." (PRESET) Button 4 times, setting the Preset menu to "MANUAL TUNE".

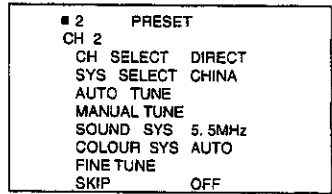

Manual Search Condition.

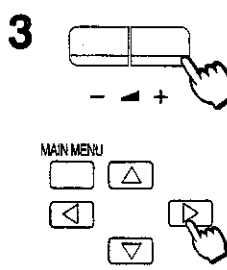

3 Push the Volume Up "+" or Down "-" Button, briefly.

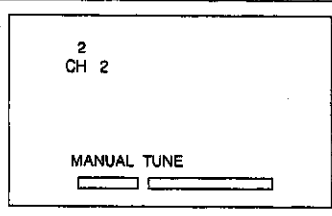

The best tuning position is automatically memorized. (In other words, manually tune away from the transmission, and then back to it.)

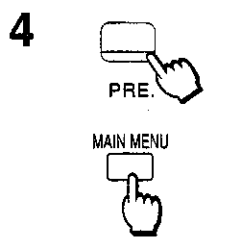

4 Push the "PRE." (PRESET) Button 5 times.

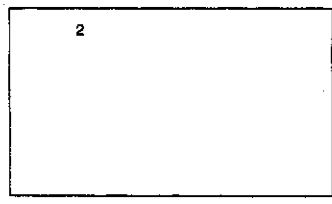

This returns the set to the normal viewing condition.

# Programme Number Skip

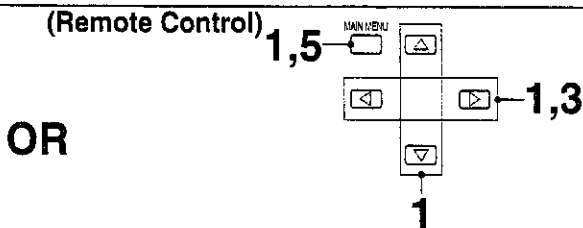
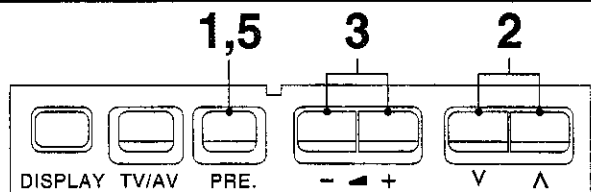

(TV set)

It is possible to skip Programme Numbers on which no TV stations are tuned appearing on the screen. The function is only effective when selecting Programme Numbers by pushing the Programme Number Up or Down Buttons either on the TV set or the Remote control.



1 Push the "PRE." (PRESET) Button 8 times, setting the Preset menu to "SKIP".

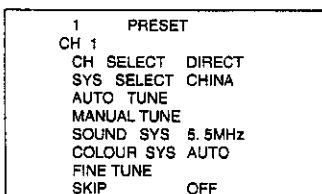

Channel Skip Condition.

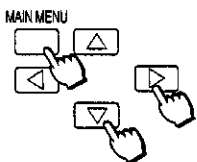

Push the "MAIN MENU" and "Position" Buttons, until the Preset Menu to "SKIP".

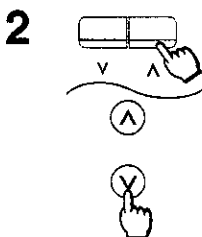

2 Select a Programme Number you want to skip by pushing the Programme Number Up "^" or Down "v" Button.

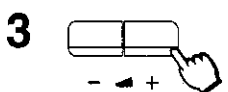
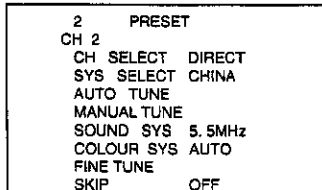

3 Push the Volume Up "+" or Down "-" Button.



The displayed "OFF" condition changes to "ON".

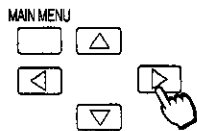

Push the Position Left "<" or Right ">" Button.



4 Repeat Steps 2 and 3 for the remaining Programme Numbers for which the Skip function is desired.



5 After the Skip Operation is completed, push the "PRE." (PRESET) Button (once).

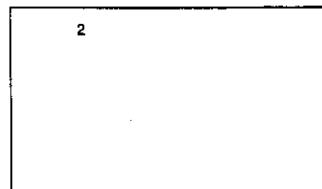

This returns the set to the normal viewing condition.



After the Skip Operation is completed, push the "MAIN MENU" Button twice.

# How to Cancel the Skip Function

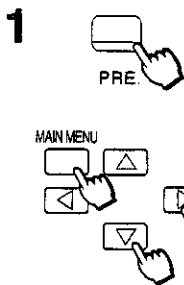
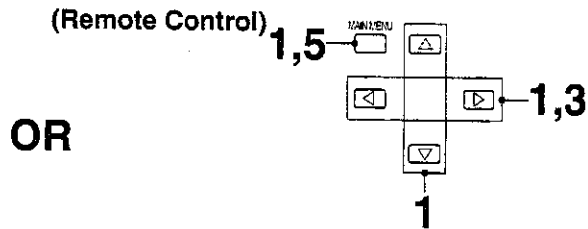
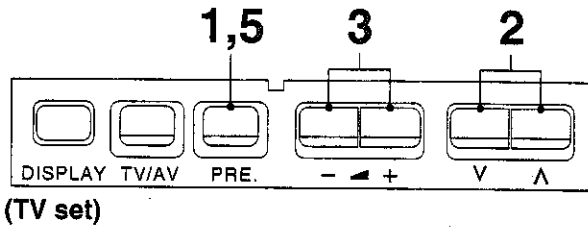

1 Push the "PRE." (PRESET) Button 8 times, setting the Preset menu to "SKIP".

Push the "MAIN MENU" and "Position" Buttons, until the Preset Menu to "SKIP".

1	PRESET
CH 1	
CH SELECT	DIRECT
SYS SELECT	CHINA
AUTO TUNE	
MANUAL TUNE	
SOUND SYS	5.5MHz
COLOUR SYS	AUTO
FINE TUNE	
SKIP	OFF

Channel Skip Condition.

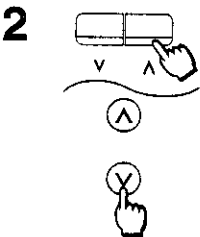

2 Select a skipped Programme Number, by pushing the Programme Number Up "∧" or Down "∨" Button.

2	PRESET
CH 2	
CH SELECT	DIRECT
SYS SELECT	CHINA
AUTO TUNE	
MANUAL TUNE	
SOUND SYS	5.5MHz
COLOUR SYS	AUTO
FINE TUNE	
SKIP	ON

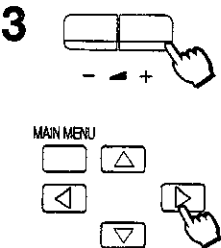

3 Push the Volume Up "+" or Down "-" Button.

Push the Position Left "<" or Right ">" Button.

2	PRESET
CH 2	
CH SELECT	DIRECT
SYS SELECT	CHINA
AUTO TUNE	
MANUAL TUNE	
SOUND SYS	5.5MHz
COLOUR SYS	AUTO
FINE TUNE	
SKIP	OFF

The displayed "ON" condition changes to "OFF".



4 Repeat Steps 2 and 3, if you wish to cancel the skip function on any other Programme Number.

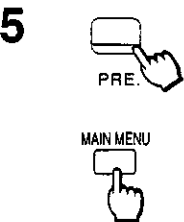

5 After the Skip Cancel Operation is completed, push the "PRE." (PRESET) Button (once).

After the Skip Cancel Operation is completed, push the "MAIN MENU" Button twice.

2	
---	--

This returns the set to the normal viewing condition.

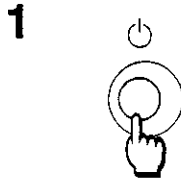
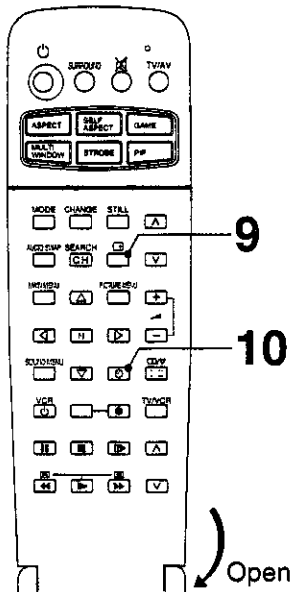
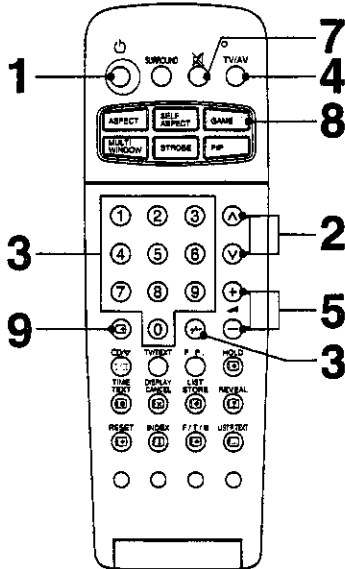
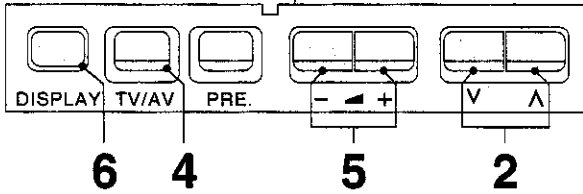
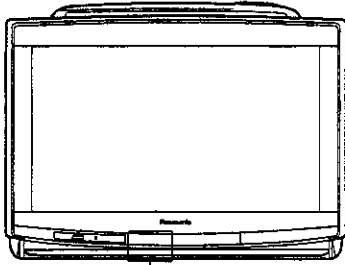

### 1 How to switch the power ON or OFF

The TV set must first be switched on at the wall outlet and at the Power Switch. (Refer to page 7)

Push this button to turn the TV set ON, from STANDBY mode.

Push it again to turn the TV set OFF, STANDBY mode.

#### Note:

It is also possible to turn the TV set on STANDBY by pushing the "Direct Programme Number Selection" Buttons (0-9) and the "Programme Number Up or Down" Button, either on the set or on the Remote Control.

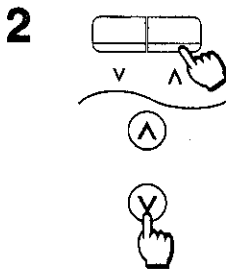

### 2 Programme Number Selection

Push the Programme Number Up "^" or Down "v" Button to select the next higher or lower Programme number.

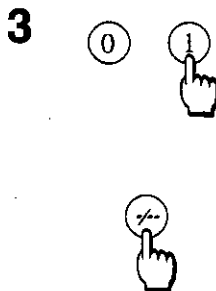

### 3 Direct Programme Number Selection (CH SELECT = POS.)

You can select the numbers directly by pushing "Number 0 - 9" button and the two digit Numbers by pushing "Two Digit" and "Programme Number" buttons.

Programme Number 8..... 8

Programme Number 12..... 1, 2

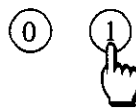

### Direct Programme Number Selection (CH SELECT = DIRECT)

You can select the number directly by pushing the corresponding programme number button.

Programme Number 8..... 8

Programme Number 36..... 3, 6

Programme Number 124.... 1, 2, 4

#### Note:

When the Skip setting for Programme Number 100 through 125 is on, the channel Selection time will be shorted, and thus you can not input three digits at a time.



### 4 TV/AV Mode Selection

Push the "TV/AV" Button to select TV, AV1, AV2, AV3 input signal modes sequentially.

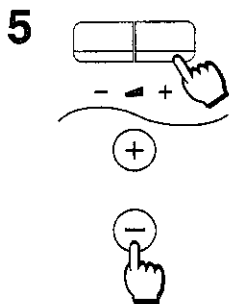

**5 Volume Adjustment**  
 Push the Volume Up "+" or Down "-" Button to increase or decrease the sound volume level.

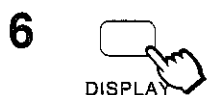
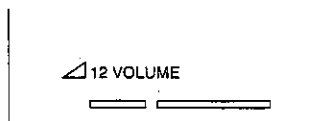

**6 Display Button**  
 By pushing the Display button various demonstrations and on-screen displays will appear. Push the Display button a second time to halt the display/demonstration mode, and return the set to the normal viewing condition.

**Note:**  
 When this button is pushed, the Picture and Sound Menus change to Picture (AUTO) and Sound (3D WOOFER).



**7 Mute Button**  
 Push this button to mute the sound completely. The "Mute" symbol will appear. (colour change to Red)

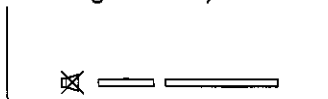

Push the button once again to restore the previous sound level, and cancel the mute.



**8 GAME Button**  
 This button provides a convenient switching feature. Push button when playing a game to switch to the AV mode set in the Game mode (refer to page 51), and the picture and sound menus set for the game are displayed.

Push again to cancel.

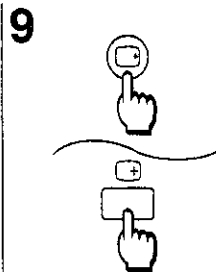
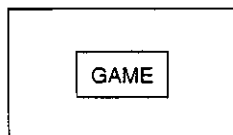

**9 Recall Button**  
 Push the "Recall" Button to display the current system status. Push again to cancel.

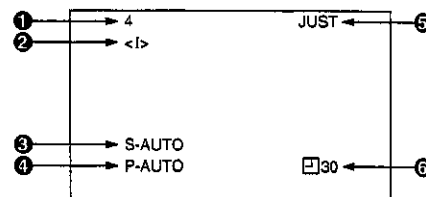

- 1 Programme Number (Refer to page 30)
- 2 Audio Mode (Refer to page 42)
- 3 Sound Menu (Refer to page 46)
- 4 Picture Menu (Refer to page 45)
- 5 Aspect Ratio (Refer to page 34)
- 6 OFF Timer (Refer to page 31)

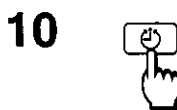

**10 Off Timer Button**  
 The TV set may be preset to switch to stand-by after a fixed period. By pushing "OFF-Timer" Button, you can select the preset time; either "30", "60", "90" minutes or AUTO Mode.

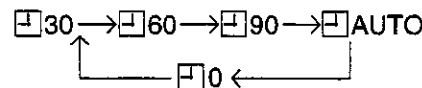

Setting Off-Timer to AUTO mode. If the set is not switched off when the TV station stops broadcasting, it will automatically go to Stand-by Mode after 5 minutes.

**Note:**  
 Off-Timer setting will not operate in AUTO mode when the Television set is in AV Mode.

## Sound System Selection (Different countries use differing systems)

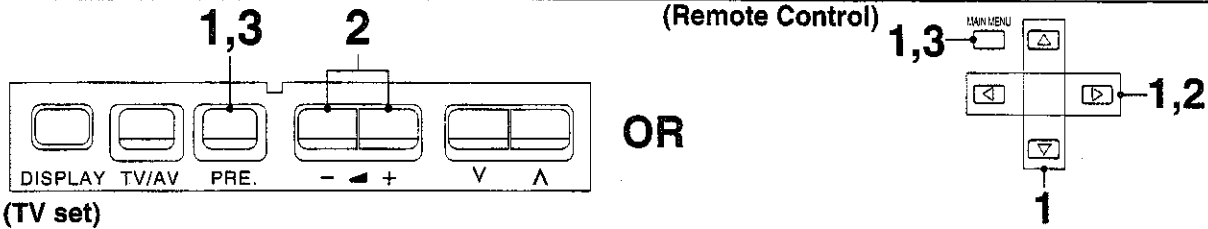

This function is used only in the TV mode, and is not applicable in AV Mode when the sound is not clear or no sound is produced on a Programme Number.

- 1** Push the "PRE." (PRESET) Button 5 times.
- Push the "MAIN MENU" and "Position" Buttons, until the Preset Menu to "SOUND SYS".

```

1 PRESET
CH 1
CH SELECT DIRECT
SYS SELECT CHINA
AUTO TUNE
MANUAL TUNE
SOUND SYS 4.5MHz
COLOUR SYS AUTO
FINE TUNE
SKIP OFF
    
```

Sound System Condition.

- 2** Push the Volume Up "+" or Down "-" Button repeatedly until the optimum sound is obtained.
- Push the Position Left "<" or Right ">" Button repeatedly until the optimum sound is obtained.

```

1 PRESET
CH 1
CH SELECT DIRECT
SYS SELECT CHINA
AUTO TUNE
MANUAL TUNE
SOUND SYS 5.5MHz
COLOUR SYS AUTO
FINE TUNE
SKIP OFF
    
```

The sound system will change as shown.

4.5MHz ↔ 5.5MHz  
 ↓ ↑  
 6.5MHz ↔ 6.0MHz

**Note:**  
 These are different sound broadcast transmission systems applicable to differing countries.

- 3** Push the "PRE." (PRESET) Button 4 times.
- Push the "MAIN MENU" Button twice.

```

1
    
```

This returns the set to the normal viewing condition.

The selected Sound System is automatically memorised.



# Colour System Selection (Different countries use differing systems)

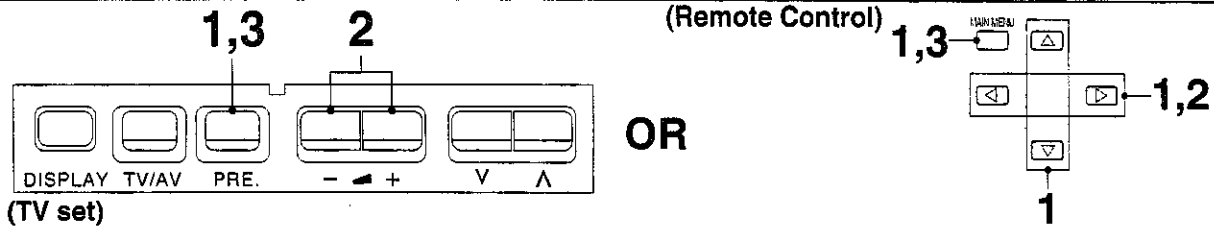

If a clear picture with current colours cannot be obtained when a Broadcast or AV signal is received.

- 1**
- Push the "PRE." (PRESET) Button 6 times.
- Push the "MAIN MENU" and "Position" Buttons, until the Preset Menu to "COLOUR SYS".

```

1 PRESET
CH 1
CH SELECT DIRECT
SYS SELECT CHINA
AUTO TUNE
MANUAL TUNE
SOUND SYS 5.5MHz
COLOUR SYS AUTO
FINE TUNE
SKIP OFF
    
```

Colour System Condition.

- 2**
- Push the Volume Up "+" or Down "-" Button repeatedly until the optimum image is produced.
- Push the Position Left "<" or Right ">" Button repeatedly until the optimum image is produced.

```

1 PRESET
CH 1
CH SELECT DIRECT
SYS SELECT CHINA
AUTO TUNE
MANUAL TUNE
SOUND SYS 5.5MHz
COLOUR SYS PAL
FINE TUNE
SKIP OFF
    
```

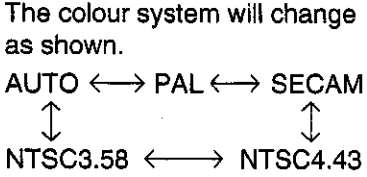

**Note:** PAL, SECAM and NTSC 3.58 are different colour signal broadcast transmission systems applicable to differing countries NTSC 4.43 is a trick playback mode used in special VCR's to playback NTSC recorded video tapes through PAL television equipment.

- 3**
- Push the "PRE." (PRESET) Button 3 times. (In AV Mode it is only necessary to push the "PRE." (PRESET) button once.)
- Push the "MAIN MENU" Button twice.

```

1
    
```

This returns the set to the normal viewing condition.

The selected Colour System is automatically memorised.

# Manual ASPECT Operation

1



## ASPECT Button

Even when this TV is in 4 : 3 screen mode, you can widen the picture tube width to the full screen and enjoy a close-up image.

By pushing the "ASPECT" Button, you can sequentially select the Aspect Ratio as below.

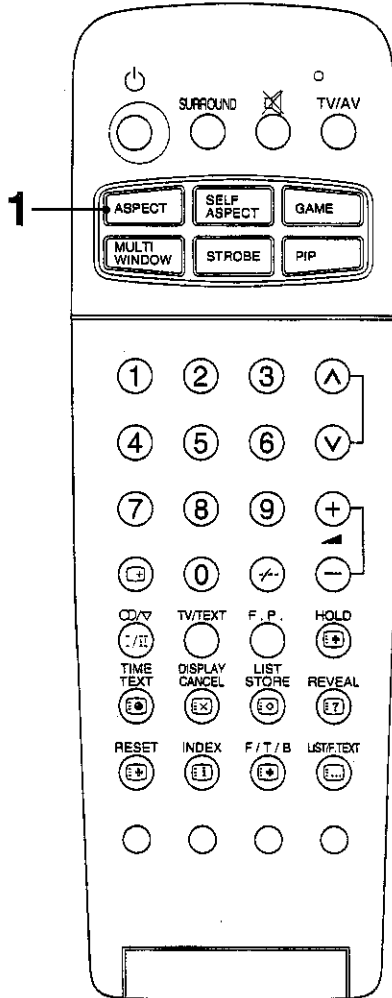

Wide Screen condition is as shown below.

TV Mode	TEXT Mode	AV Mode
4 : 3	FULL	4 : 3
↓	→	↓
ZOOM1	FULL	ZOOM1
↓	→	↓
ZOOM2	FULL	ZOOM2
↓	→	↓
FULL	FULL	FULL
↓	→	↓
JUST	FULL	JUST

### Note:

- (1) The screen size will be stored in memory for each mode (TV, AV1, AV2 and AV3).
- (2) The screen position and V(Vertical)-size can be changed in the ZOOM 1 and ZOOM 2 modes also the screen position can be changed in the JUST mode, and the side band can be changed in the 4 : 3 mode (Refer to page 49 for details).
- (3) When a full picture signal from the special video is detected by S1-Video Terminal of the unit, the screen size automatically sets to FULL.
- (4) The monitor output will not change even if the screen size and screen position are adjusted.
- (5) There is a wide variety of software available with aspect ratios from 1.78 : 1 (16 : 9) to 2.35 : 1 (cinema vision). Therefore, black portion will be visible at the top and bottom of the screen even in ZOOM 1 (16 : 9) mode depending on the software (for example: cinema vision).

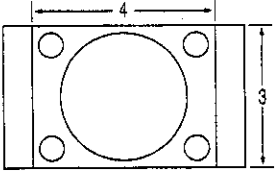
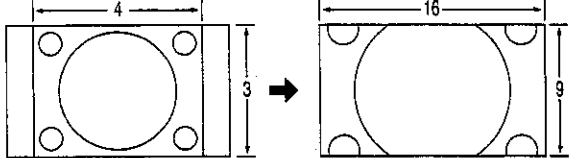
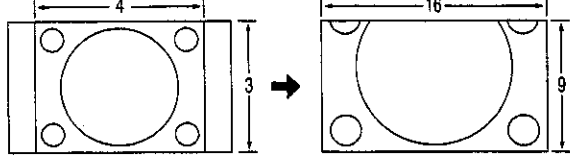
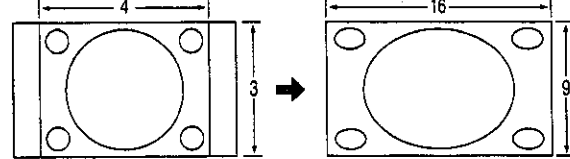
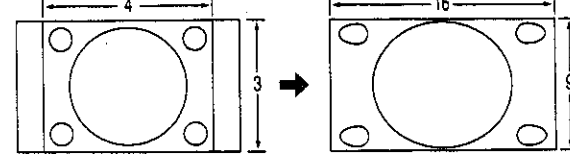
Mode	Screen	Explanation
4 : 3	 <p>Used when enjoying a 4 : 3 mode.</p>	Normal TV broadcast screen (4 : 3)
ZOOM1	 <p>This function is to be used when enjoying vista vision or cinema vision size software.</p>	<p>Since the both the vertical and horizontal display are expand at the same rate, widening the picture will not result in an elongated image, so that the viewer can enjoy a wide screen image without distortion.</p> <p><b>Note:</b> The top and bottom of the picture may disappear, however.</p>
ZOOM2	 <p>The subtitles disappeared in the ZOOM 1 mode will be visible without adjusting the top and bottom of the screen.</p>	<p>The vertical and horizontal directions will be expanded at the same rate, and the vertical direction at the bottom of the screen will be compressed.</p> <p><b>Note:</b> The bottom portion of the screen will be visible as a compressed image.</p>
FULL	 <p>Used to return the width compressed full picture (S1 picture signal input) to normal, for full mode enjoyment.</p>	<p>Since the horizontal borders will be expanded to the width of the tube without changing the horizontal section, you can enjoy a wide screen without cutting the image. When the full picture is software the compressed image will return to the normal image, and will be expanded to the full area of the picture tube.</p> <p><b>Note:</b> A Normal picture will become elongated.</p>
JUST	 <p>Used to enjoy a wide 4 : 3 mode picture with little irritation.</p>	<p>The left and right borders will be slightly widened. However the centre image will not be as elongated as in a full image, so no feeling of distance from the screen will occur.</p> <p><b>Note:</b> This will result in a slightly elongated image. The top and bottom of the picture may disappear slightly.</p>

# Multi Window Operation

1



## Multi Window

The TV broadcast signals and the external signals can be viewed simultaneously.

By pushing the multi-window button to view the following multi-window conditions.

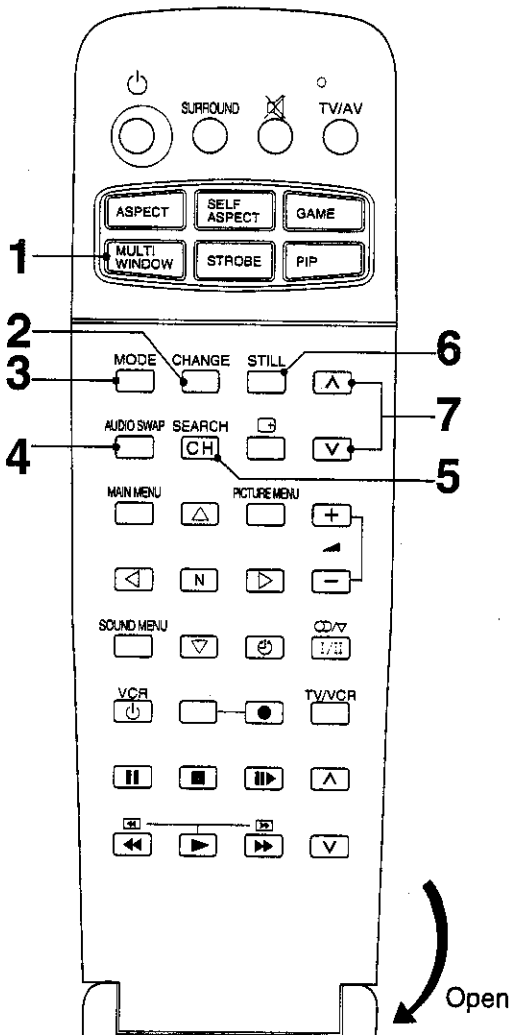

## Multi Window condition is as shown below

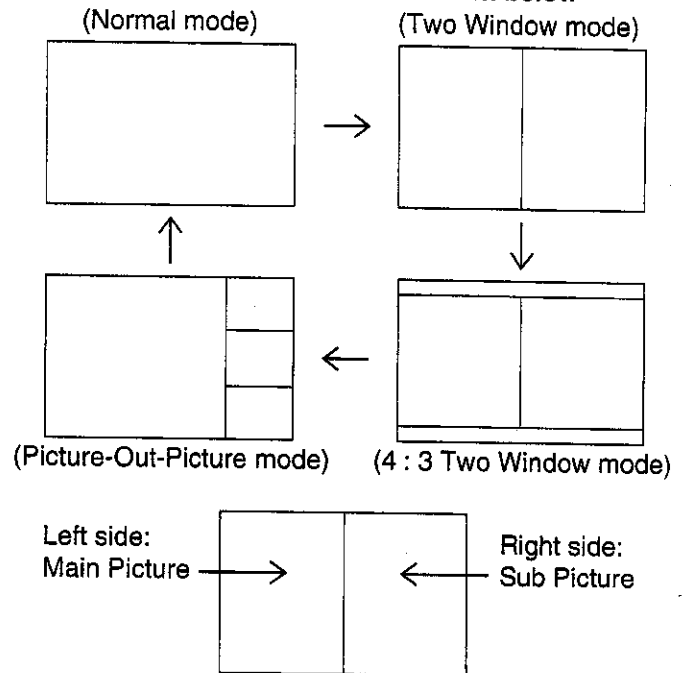

### Note:

- (1) The aspect can not be changed from within Multi Window.
- (2) When the main picture is in PAL or SECAM system and the sub picture is in NTSC system, the different systems will cause a black band to appear at the top and bottom of the sub picture.
- (3) When the set to two window mode, the left and right picture are processed by two different circuits. Therefore there may be a minor difference in clarity between the pictures.

2



## Main/Sub picture CHANGE

Push the "CHANGE" Button to SWAP from Main picture to Sub picture and vice versa.

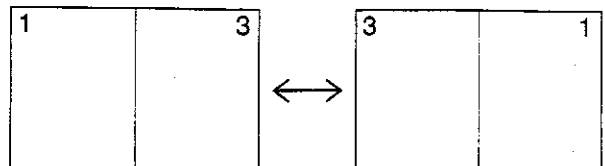

3



**Sub picture TV/AV MODE Selection**

To change the Mode of the Sub picture, push the "MODE" Button. By pushing the "MODE" Button, select the Sub picture mode as follows.

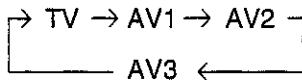

4



**Audio Swap**

The AUDIO SWAP button is the changeover button for the sounds (audio programme content) of the Main and Sub picture. Push this button to hear the sound of the Sub picture. However, note that the sound of Main picture can not be heard when the Sub picture sound is selected.

(Two Window Mode)

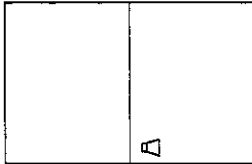

(Picture-Out Picture Mode)

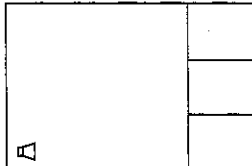

Push again to cancel.

5

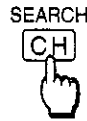

**Sub picture channel SEARCH**

By pushing this button, it is possible to search through all programmed positions (Skip off) and display a picture in the Sub picture screen.

Two Window Mode

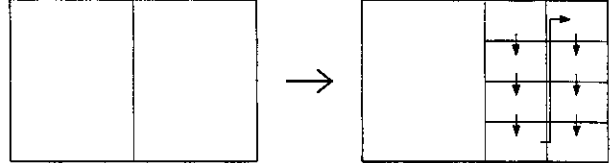

Picture Out Picture Mode

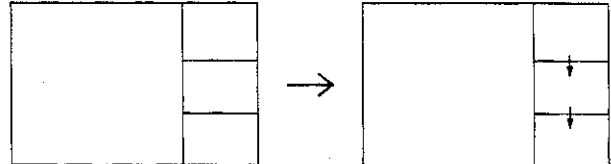

Push again to stop the channel search.

6



**STILL**

The Still function can be used to freeze the action on the screen and display a still picture of the Sub picture.

Push the "STILL" button, the Sub picture changes to freeze the moving picture into a still picture.

Push again to cancel.

When pushed in normal mode (Multi Window mode OFF), a freeze frame of the Main Picture will be displayed as a sub-picture while the action in the Main picture continues.

7

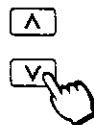

**Sub picture Programme Number Selection**

Push the Sub picture Programme Number Up "▲" or Down "▼" Button to select the next higher or lower tuned channel.

# SELF ASPECT Operation

1



## SELF ASPECT

Best aspect ratio will be selected automatically according to the source on the image being displayed when Self Aspect is "on" condition.

A "Just" or "Zoom" mode is displayed depending on the picture sent.

You can choose aspect ratio either a "4 : 3" mode or a "Just" mode by Self aspect mode (Refer to page 51) for 4 : 3 source reception.

Push again to turn the Self Aspect "off" for manual aspect operation.

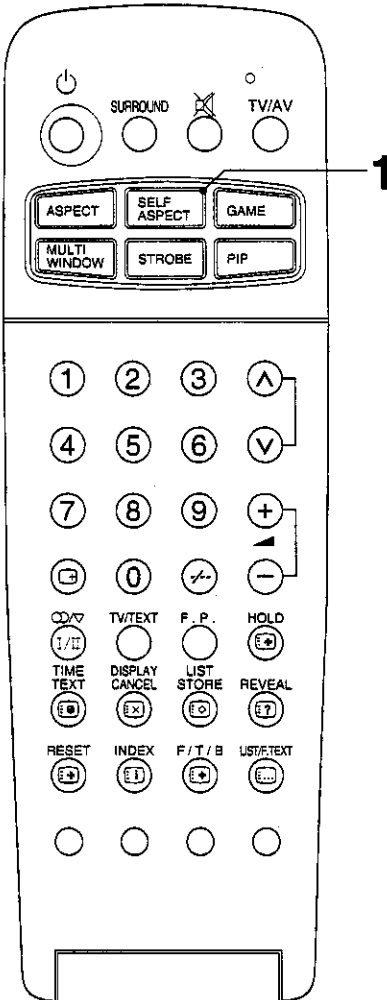

## Helpful Hint

- (1) The aspect becomes full for full pictures signal from the wide TV compatible S1 picture signal input, even when the self aspect is "on".
- (2) When viewing video software, depending on the software the screen size may not zoom for a brief period during initially dark picture, even when the screen size is set to automatic zoom mode.
- (3) When using game software, the screen size may appear in a zoom mode (making for poor display of the top and bottom portions). If this occurs, select the screen size to "Full" mode or "4 : 3" mode.

# STROBE Operation

1



## STROBE

Push the "STROBE" button to display the sub-picture with a strobe effect. When the "STROBE" is on, push the "STROBE" button again to turn off the strobe, or push the "STILL" button to freeze the strobe image. Push the "STILL" button again to restart the strobe effect.

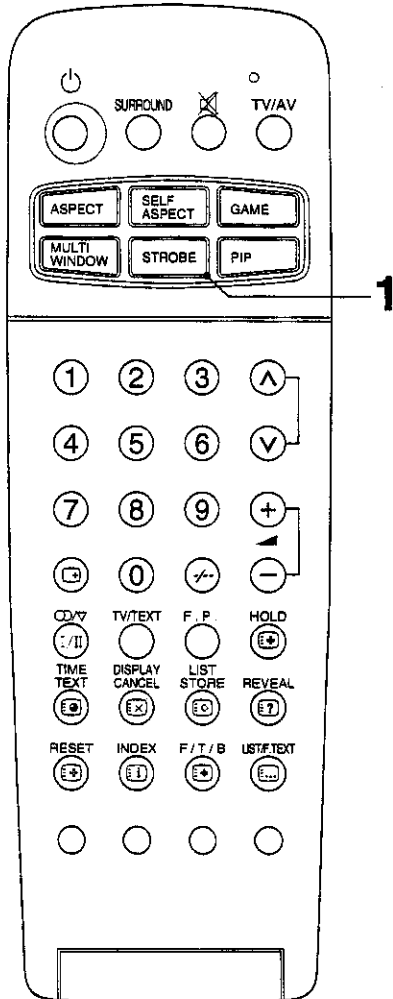

Two Window Mode

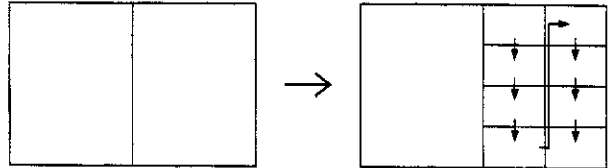

Picture Out Picture Mode

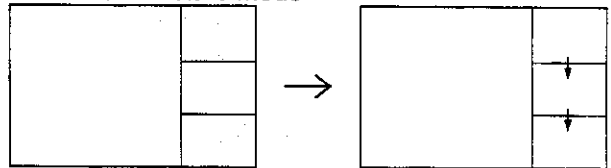

# Picture in Picture Operation

1



## Picture in Picture

Push the "PIP" Button to superimpose a small picture within the main picture. By pushing the "PIP" Button to superimpose two kinds of small picture size within the main picture.

Push the "PIP" Button twice to cancel.

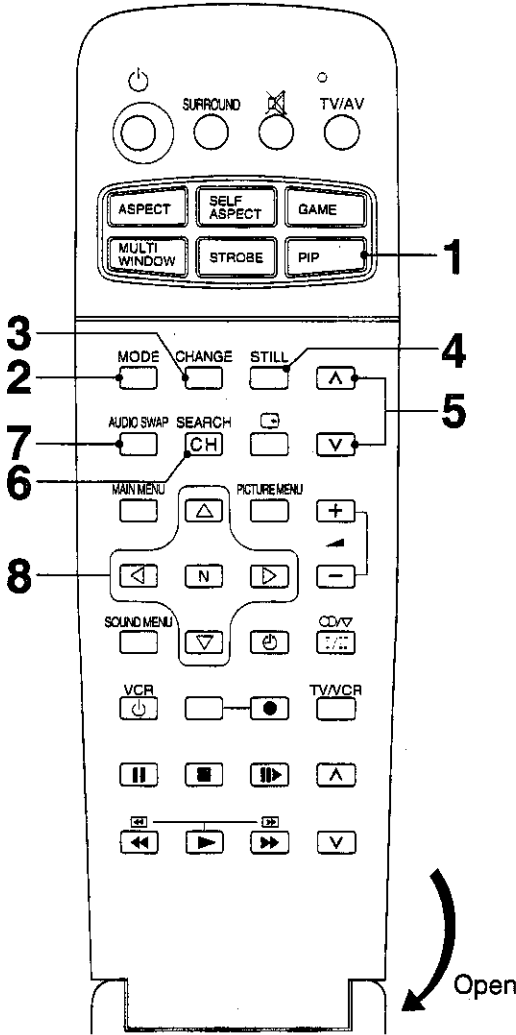

## On-Screen indications

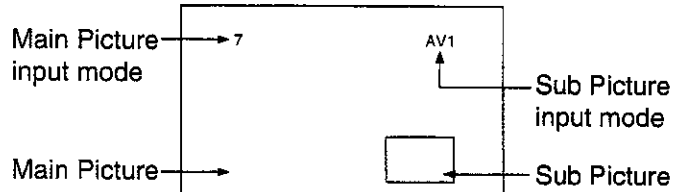

## Note:

The size of the Sub picture will differ depending on the aspects of the Main picture.

2



## Sub picture MODE Selection

To change the Mode of the sub picture, push the "MODE" Button.

By pushing the "MODE" Button, select the Sub picture mode as follows.

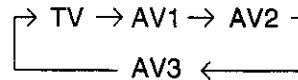

3

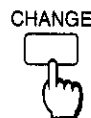

## Main/Sub picture CHANGE

Push the "CHANGE" Button to SWAP from Main picture to sub picture and vice versa.

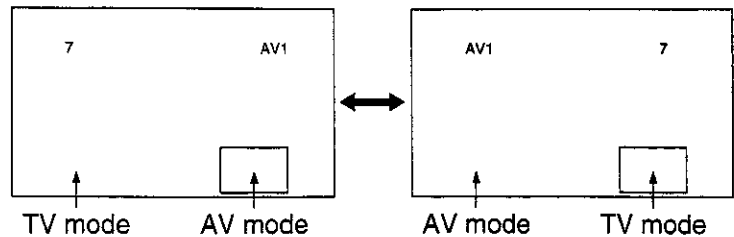



4



**STILL**

The Still function can be used to freeze the action on the screen and display a still picture of the Sub picture.

Push the "STILL" Button to freeze the moving picture into a still picture.

Push again to cancel.

7



**AUDIO SWAP**

The AUDIO SWAP button is the changeover button for the sounds (audio programme content) of the MAIN and SUB Picture.

Push it to hear the sound of the SUB Picture. However, note that the sound of MAIN Picture can not be heard when the SUB Picture sound is selected.

Push again to cancel.

5

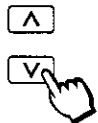

**Sub picture Programme Number Selection**

Push the Sub picture Programme Number Up "A" or Down "V" Button to select the next higher or lower tuned channel.

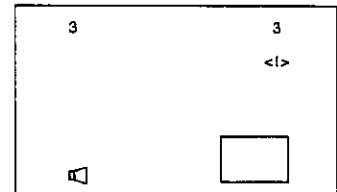

6



**Sub picture Channel SEARCH**

By pushing this button, it is possible to search through all programmed numbers and display a picture on the sub picture screen.

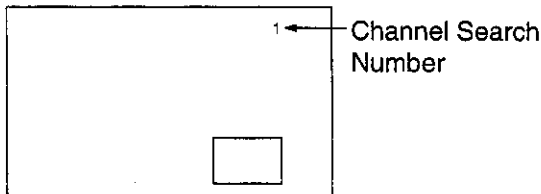

Push again to stop the channel search in the desired programme number.

8

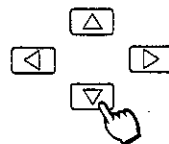

**Position Buttons**

By pushing each "Position" Button, you can easily select the desired position of the Sub Picture on the screen.

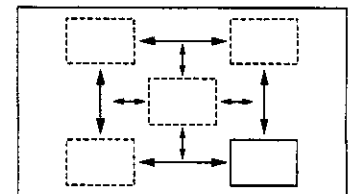

**Note:**

By pushing the Normal "N" Button while the picture in picture mode is activated, the Sub Picture position will move to the bottom Right corner.

## Stereo Reception (The TX-28/32WG25C does not have this function.)

1

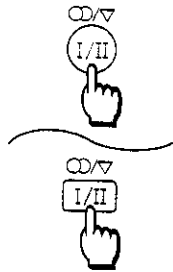

### Stereo/Bilingual Sound Selection Button

Sound output modes can be selected by pushing the "Sound Selection" Button.

"STEREO" (if transmitted), "BILINGUAL" (if transmitted) and "MONO" modes can be selected using this button.

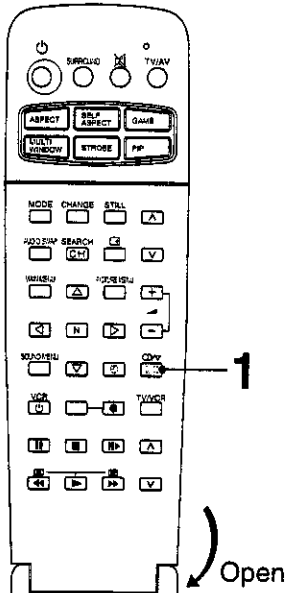
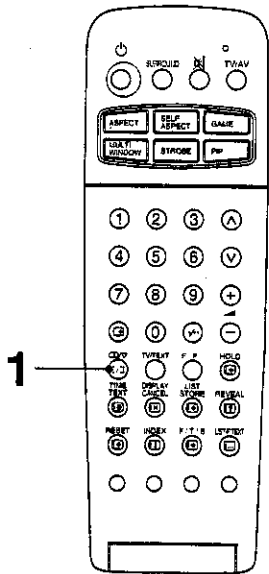

Audio Signal	Indicator
STEREO	⊕
MAIN < I >	< I >
SUB < II >	< II >
MONO	▽





### Note:

(1) The "A2 (German)" stereo/bilingual TV sound transmission system is used in the following countries; Australia, Malaysia, Thailand, Indonesia, etc.

The "NICAM" stereo TV sound transmission system is used in the following countries; New Zealand, Singapore and Hong Kong.

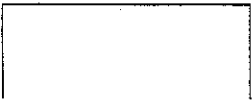
(2) If the stereo signal is weak or the receiving conditions are poor or if STEREO: MONO automatic switching occurs, it is recommended to switch to the "Mono" Mode.

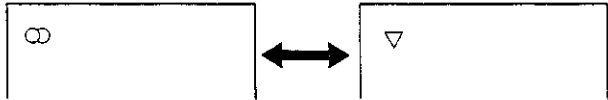
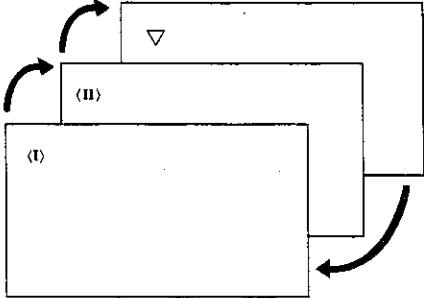
When the broadcasting mode changes to "STEREO", "DUAL", or "MONO" after you have selected "MONO" mode, change over to either "STEREO" or "MAIN" Modes will be made automatically. "DUAL" also known as "BILINGUAL" mode is not currently transmitted in some countries.

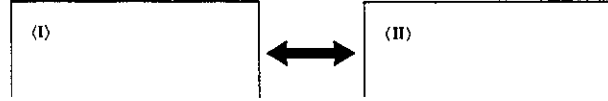
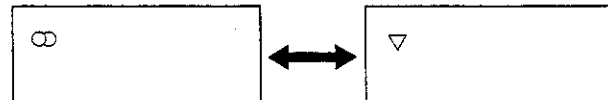
Type of Stereo	Type of broadcast	On-screen indication	Remark
NICAM Digital Stereo	Regular broadcast (Standard Audio)		Normal use
	Regular + NICAM MONO I (MAIN<I>)		You can select either the "MAIN<I>" or "MONO" audio signal.
	NICAM STEREO		You can select either the "STEREO" or "MONO" mode.
	NICAM DUAL MONO (MAIN<I>/SUB<II>)		You can select either the "MAIN<I>, SUB<II>" or "MONO".
A2 (German) Stereo	Regular broadcast (Standard Audio)		Normal use
	BILINGUAL or DUAL MONO: MAIN<I>/SUB<II>		You can select either the "MAIN<I>" or "SUB<II>" audio signal.
	STEREO		You can select either the "STEREO" or "MONO" mode.

**Note:**

- (1) Even when the contents of the receiving signal undergo changes, selection mode is kept intact.
- (2) When the receiving conditions deteriorate, listening will be easier if the mode is set to the "MONO" position, using the Stereo/Bilingual Sound selection button as shown on page 42.
- (3) "DUAL", also known as "DUAL MONO" or as "BILINGUAL" is not currently transmitted in some countries.

# Surround Operation

1

SURROUND

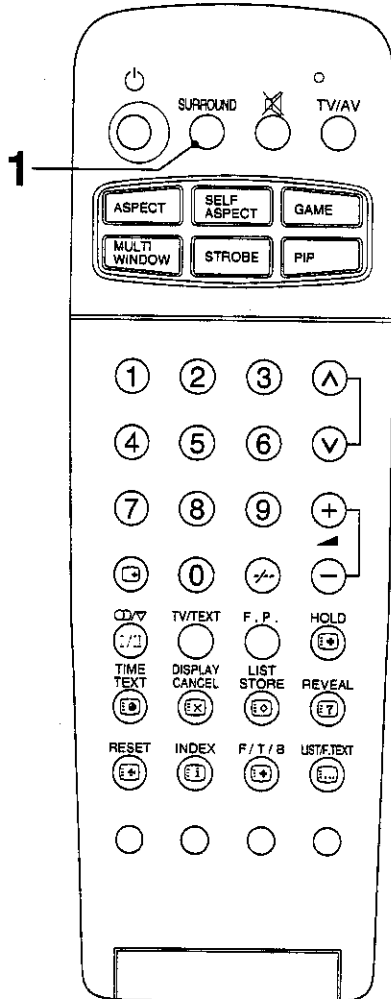

## Surround Button

The benefits of surround sound are enormous. With additional speakers you can be completely enveloped in sound; just as if you were at a concert hall or cinema.

The surround effect does operate without external surround speakers, but is enhanced when they are connected. Such near surround speakers should not be sited in direct proximity to the listeners.

## On-Screen display during surround mode.

	Type of broadcast	On-screen display
TV Mode	<ul style="list-style-type: none"> <li>• MONO (Including STEREO switched to MONO by you) and BILINGUAL</li> </ul>	MONO SURROUND ↓ SURROUND OFF
	<ul style="list-style-type: none"> <li>• STEREO (For TX-28WG25X TX-32WG25X)</li> </ul>	STEREO SURROUND ↓ SURROUND OFF
AV Mode	<ul style="list-style-type: none"> <li>• Select the AV mode (AV1, AV2 and AV3)</li> </ul>	STEREO SURROUND ↓ MONO SURROUND ↓ SURROUND OFF

**Note:** If the stereo signal is poor or the receiving conditions are not optimum or if STEREO: MONO automatic switching occurs, it is recommended that "STEREO" switch to MONO (Refer to page 42) be used. If problems or unusual sudden effects are encountered in any of the surround modes, it is recommended that "SURROUND OFF" be selected.

# Picture Menu Operation

1

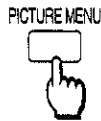

By pushing the "PICTURE MENU" Button, you can sequentially select the Picture Menus as shown below.

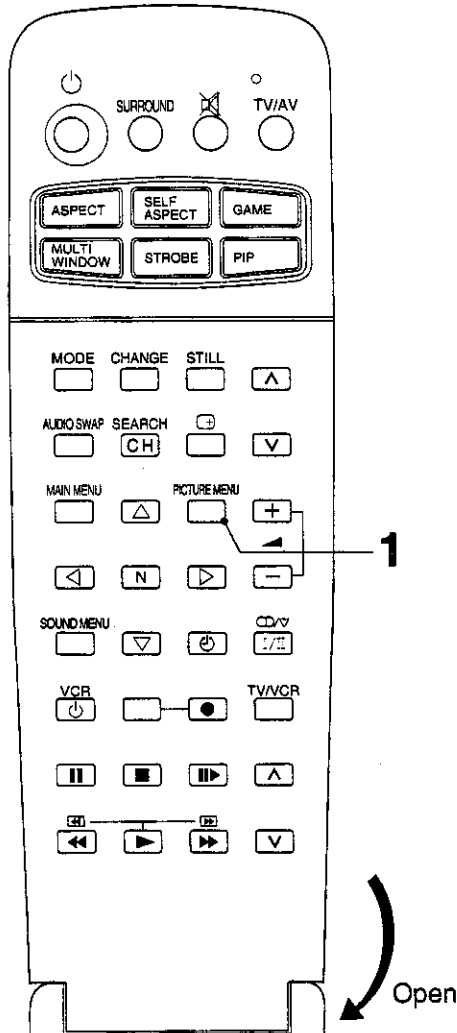

On-Screen	Function
P-AUTO	As the TV video signal is processed for immediate reception, "Brightness", "Contrast", "Tint of colour", etc. are automatically adjusted to the optimum conditions.
P-STANDARD	For watching in normal (evening lighting) environments. This menu selects the normal level of Brightness and Contrast.
P-GAME	Reduces the contrast and sharpness when used in a game mode, and displays a picture which is easy on the eyes.

## Helpful Hint

- (1) You can change the level of each Function (COLOUR, NTSC-TINT, BRIGHT, CONTRAST, SHARPNESS) for each picture menu. Please refer to pages 48 and 49.
- (2) Picture menu mode will be memorized for each TV, AV1, AV2, AV3 and GAME mode.

# Sound Menu Operation

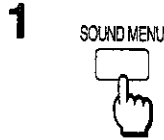

By pushing the "SOUND MENU" Button, you can sequentially select the Sound Menus as shown below.

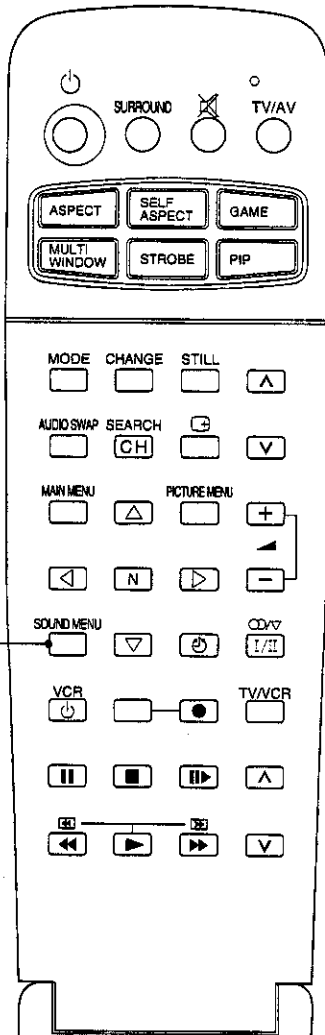

On-Screen	Function
S-AUTO	Sound and Music signals are altered and the best sound is automatically adjusted; sound (e.g. News and Human voice, etc.) is adjusted so as to be easy to hear and music is adjusted to give background impression.
S-STANDARD	For Normal use.
S-3D WOOFER	Amplifies the low frequencies and outputs the optimum sound.

## Helpful Hint

- (1) You can change the level of each Function (BASS, TREBLE, BALANCE, SURROUND) for each Sound Menu. Please refer to pages 48 and 49.
- (2) Sound menu mode will be memorized for each TV, AV1, AV2, AV3 and GAME mode.



# Main Menu Operation

The "MAIN MENU" screen will change as follows.  
You can change/select the condition of each item on the menu.

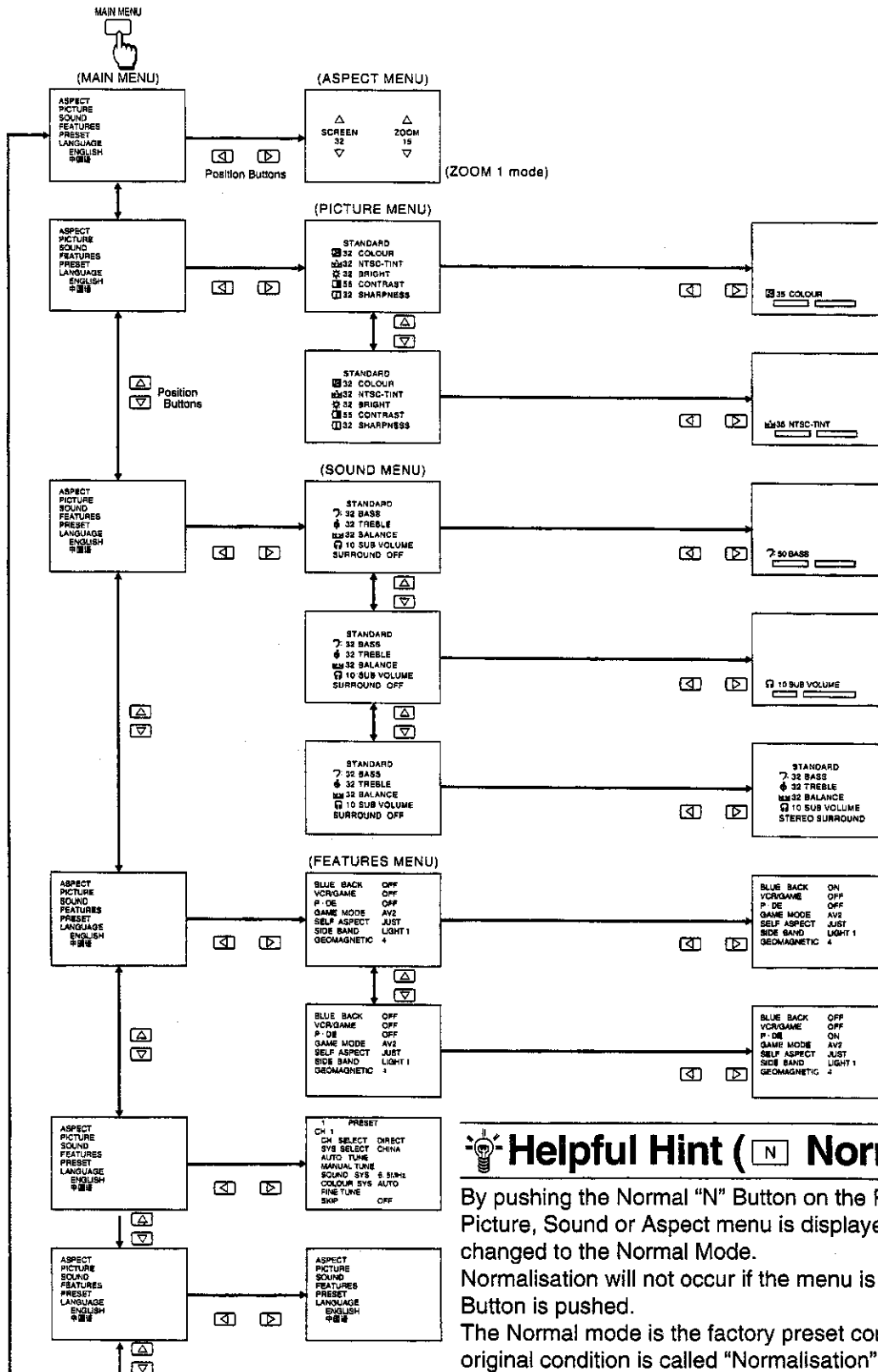



## ASPECT Menu

ZOOM 1, ZOOM 2 mode

You can change the screen position up and down or the V(Vertical)-size to see a concealed image.

JUST mode

The screen position can be changed up and down.

Options can be selected by pushing the position Left "<" or Right ">" buttons [screen, V(Vertical)-size], and the position can be adjusted by pushing the Up "▲" or Down "▼" buttons.

4 : 3 mode

The side band width can be adjusted to two levels. Push the position Left "<" or Right ">" buttons to adjust the side band width to two levels.

### Note:

The monitor output will not change even if the V(Vertical)-size and screen position is adjusted.

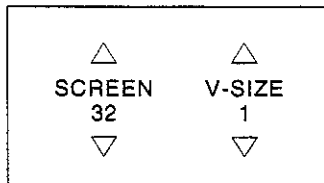

Select the "SCREEN" condition.

(Only for ZOOM 1, ZOOM 2, and Just mode.)

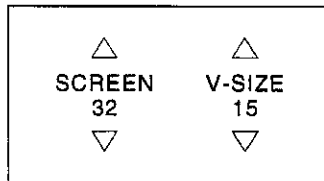

Select the "V-SIZE" condition.

(Only for ZOOM 1 and ZOOM 2 mode.)

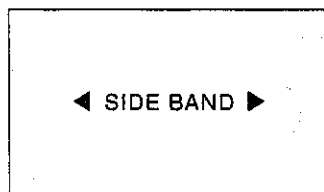

Select the "SIDE BAND" condition.

(Only for 4 : 3 mode.)

## Picture Menu

Item	Push	Effect	Indicator
COLOUR	MAIN MENU → [▼] [▲]	[◀] [▶] Less More	[32] COLOUR [ ]
NTSC-TINT	MAIN MENU → [▼] [▲]	[◀] [▶] Greenish Reddish	[32] NTSC-TINT [ ]
BRIGHT	MAIN MENU → [▼] [▲]	[◀] [▶] Darker Brighter	[32] BRIGHT [ ]
CONTRAST	MAIN MENU → [▼] [▲]	[◀] [▶] Less More	[32] CONTRAST [ ]
SHARPNESS	MAIN MENU → [▼] [▲]	[◀] [▶] Less More	[32] SHARPNESS [ ]

### Note:

- (1) When the set to two window mode, the main and sub pictures are both adjusted simultaneously.
- (2) Even if the TV is not set to "NTSC" mode, "NTSC-TINT" will be displayed and level adjustment would be possible. But it would not function.

## Sound Menu

Item	Push	Effect	Indicator
BASS	MAIN MENU → [▼] [▲]	[◀] [▶] Less More	[32] BASS [ ]
TREBLE	MAIN MENU → [▼] [▲]	[◀] [▶] Less More	[32] TREBLE [ ]
BALANCE	MAIN MENU → [▼] [▲]	[◀] [▶] Left SP. Right SP.	[32] BALANCE [ ]
SUB VOLUME	MAIN MENU → [▼] [▲]	[◀] [▶] decrease increase	[10] SUB VOLUME [ ]
SURROUND	MAIN MENU → [▼] [▲]	[◀] [▶] Select	MONO SURROUND

### Note:

- (1) When SOUND AUTO mode is selected in Sound Menu Operation, BASS and TREBLE can not be adjusted and they are not displayed.
- (2) SUB VOLUME is sub headphones volume control.

## Features Menu Operation

### BLUE BACK Mode

When no picture signal is received, or the signal is weak, the screen reverts to a blue background colour and the Sound is muted.

Disable this Feature to continue watching very weak signals.

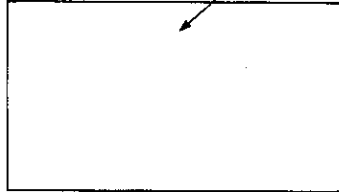

Blue if no input picture signal or input signal is weak.

#### Note:

- (1) In the Blue Back Mode the screen size is forced to FULL mode.
- (2) If BLUE BACK Mode is set on while a VCR signal is being viewed, selecting CUE or REVIEW may cause the screen to revert to the blue background colour. Disable this Feature to view correctly.

### VCR/GAME Mode

Reproduction of irregular signals, such as certain TV games and rental video tapes, may be improved.

BLUE BACK	ON
VCR/GAME	ON
P·DE	ON
GAME MODE	AV2
SELF ASPECT	JUST
SIDE BAND	LIGHT 1
GEOMAGNETIC	4

### P·DE Mode (Picture Detail Enhancer)

The Picture Detail Enhancer System is designed to improve the picture sharpness. It should be OFF position to reduce picture noise during poor quality reception conditions.

BLUE BACK	ON
VCR/GAME	ON
P·DE	ON
GAME MODE	AV2
SELF ASPECT	JUST
SIDE BAND	LIGHT 1
GEOMAGNETIC	4

When the Picture Detail Enhancer System is ON, the picture will be sharper.

BLUE BACK	ON
VCR/GAME	ON
P·DE	OFF
GAME MODE	AV2
SELF ASPECT	JUST
SIDE BAND	LIGHT 1
GEOMAGNETIC	4

When the Picture Detail Enhancer System is OFF, picture noise will be softened and less sharp.

### GAME Mode

Select the AV mode (AV1~3) which connects the game.

When the game button is pushed, the unit will switch to the AV mode set, and will enter the picture menu and sound menu adjusted for the game mode.

BLUE BACK	OFF
VCR/GAME	OFF
P·DE	ON
GAME MODE	AV2
SELF ASPECT	JUST
SIDE BAND	LIGHT 1
GEOMAGNETIC	4

The game mode Indicator will change as follows.

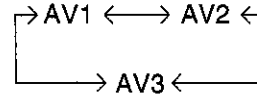

### SELF ASPECT Mode

This function makes the aspect 4 : 3 mode or a just mode if a 4 : 3 source is received when the self aspect is on.

BLUE BACK	OFF
VCR/GAME	OFF
P·DE	ON
GAME MODE	AV2
SELF ASPECT	JUST
SIDE BAND	LIGHT 1
GEOMAGNETIC	4

BLUE BACK	OFF
VCR/GAME	OFF
P·DE	ON
GAME MODE	AV2
SELF ASPECT	4:3
SIDE BAND	LIGHT 1
GEOMAGNETIC	4

### SIDE BAND Mode

Side Band brightness can be selected when the aspect is 4 : 3 mode or during the picture-out-picture.

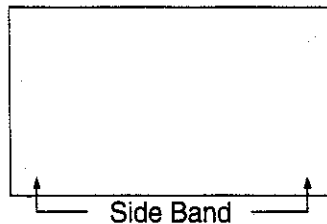

The Side Band brightness will change as follows.

LIGHT 1 ↔ LIGHT 2 ↔ DARK

A diagram showing three indicators: LIGHT 1, LIGHT 2, and DARK. They are connected by double-headed arrows, indicating they will change.

- Teletext features may vary depending on the Broadcasting Companies and is only available if the channel selected is transmitting Teletext.
- When in teletext mode, the volume may still be altered to the desired listening level.

#### What is LIST mode?

In LIST mode, four differently coloured page numbers are situated at the bottom of the screen. Each of these numbers can be altered and stored in the TV's memory.

#### What is FASTEXT?

In FASTEXT mode, four differently coloured subjects are situated at the bottom of the display. To access more information about one of these subjects, push the appropriately coloured button. This facility enables fast access to information of the subjects shown.

#### What are the advantages?

- Page selection at the touch of a Colour-coded Button.
- Easy to use step-by-step selection of the topical subject.
- Reduction of waiting time.
- Page status line at bottom of screen so you always know which Button will take you to the desired information.

#### Note:

Although Teletext can be viewed in two window mode, the Teletext screen will not appear in both the main and sub pictures.

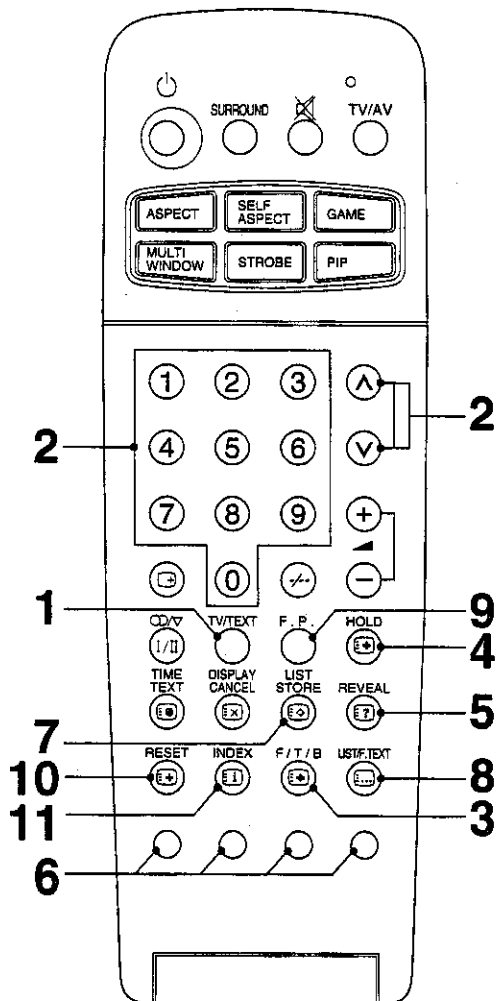

**1 TV/Teletext mode**  
By pushing the "TV/TEXT" Button, to change the TV/Teletext mode as follows.

(Two Picture)  
TV → TEXT → TV and TEXT

**2 Page Selection**  
Pages can be selected in two ways:  
a) Push the Up/Down Buttons to increase or decrease the page number by one.  
b) By entering the page number, using 0-9 on the remote control.

**3 Full/Top/Bottom**  
Push to expand the Top half of the page.  
Push again to expand the Bottom half.  
Push again to return to normal (FULL) size.

**4 Hold**  
Push to hold the current page.  
Push again to cancel the hold.

**5 Reveal**  
Push to reveal hidden words e.g. quiz page answers.  
Push again to hide.

**6 Colour-Coded Buttons**  
In FASTEXT mode these correspond to the differently coloured subjects.  
In LIST mode they correspond to the differently coloured page numbers.

**7 List Store**  
In LIST mode the four page numbers can be altered for channel positions 1-125 (CH SELECT=DIRECT)/0-99 (CH SELECT=POS.). To do this, push one of the coloured Buttons and enter the new page number.  
Push and hold List Store, the page numbers will change colour.

**8 List/F. text**  
Push to change from FASTEXT mode to LIST mode and vice versa. In FASTEXT mode four differently coloured subjects are displayed at the bottom of the page. Push the appropriate coloured Button to access more information about one of these subjects.

**9 Favourite Page (F. P. )**  
Stores a favourite page in memory for instant recall. To store such a page, the TV must be in LIST mode, and the programme position must be from 1-125 (CH SELECT=DIRECT)/0-99 (CH SELECT=POS.). Push the Light BLUE Button, select the page number, then push List Store. The page number is now stored.  
Push F.P. to recall this page.

**10 Reset**  
Push in LIST mode to reset to the RED coloured page.  
Push in FASTEXT mode to reset to the index page.

**11 Index**  
Push INDEX to return to the main index page.

# DISPLAY CANCEL

1



Push DISPLAY CANCEL to view the TV picture whilst searching for a Teletext page. When found, the screen will display the page number at the top left. Push DISPLAY CANCEL to view the page. Push TV/TEXT twice to return to normal TV operation.

## **News Flash**

When a news flash page has been selected, push DISPLAY CANCEL to view the TV picture, when an update is received, it will be displayed on screen. Push DISPLAY CANCEL to remove update news. Push TV/TEXT twice to return to normal TV operation.

## **Update**

Push DISPLAY CANCEL to see the update of information on certain pages. When an update is received, the page number will be displayed at the top left of the screen. Push DISPLAY CANCEL to view the page. Push TV/TEXT twice to return to normal TV operation.

## **Note:**

During two window mode Teletext, the Display cancel button is inoperative.

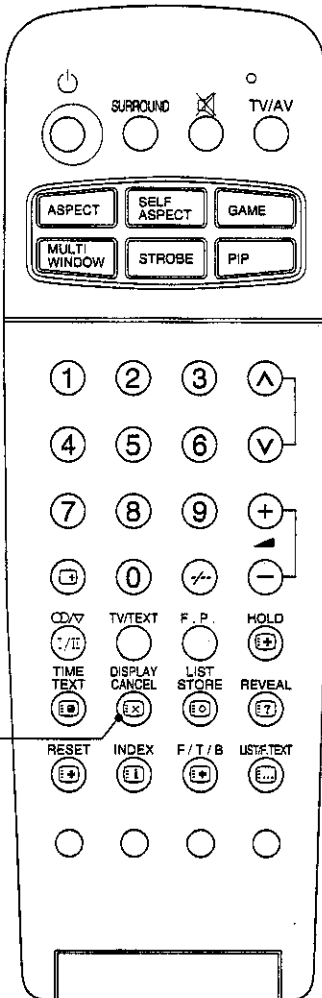

## Sub Coded Page Access

When teletext information exceeds more than one page, it may take some time for the automatic changing of the sub pages to reach the sub page you require. It is possible to enter your required sub page and continue watching the normal programme until the correct sub page is found.

Select the required page number using Buttons 0-9.

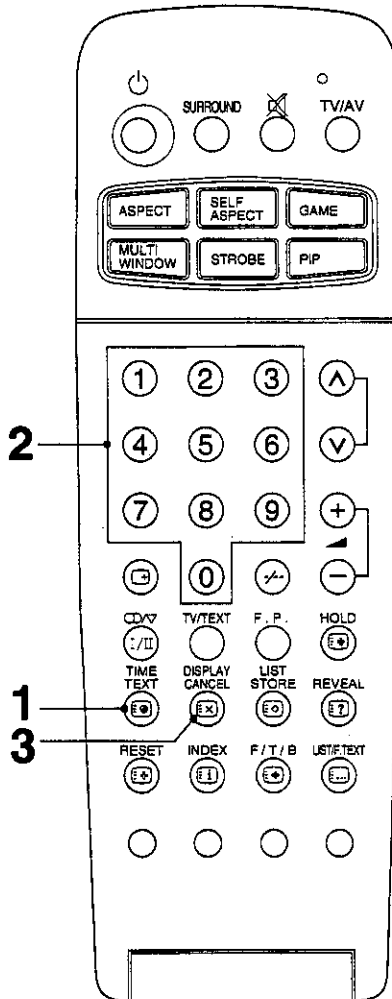

1



Push TIME TEXT "T\*\*\*\*" will be displayed (top Left of the screen).

2

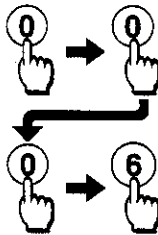

Enter desired sub page number before the "T\*\*\*\*" disappears.  
To select page 6 enter 0, 0, 0 and 6.

3



Push DISPLAY CANCEL to view a normal TV programme.

### Helpful Hint

When the page is available, push DISPLAY CANCEL to view the page.

To clear the page perform one of the following:

- Select a new page number.
- Push TV/TEXT until the normal TV operation.

Your Remote Control is designed to be used with selected Panasonic/National VCR's.  
Some model VCR's have different functions, so please refer to the individual VCR Instruction Booklet to ensure compatibility.

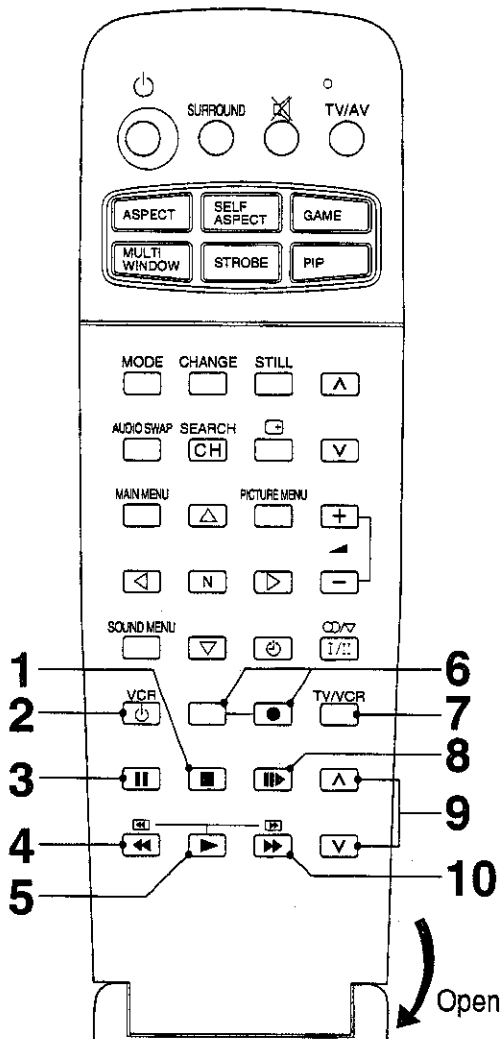

- |    |  |  |
|----|--|--|
| 1  |  | Stop Button                                  |
| 2  |  | VCR Power Button                             |
| 3  |  | Pause/Still Button                           |
| 4  |  | Rew (Rewind)/Review Button                   |
| 5  |  | Play Button                                  |
| 6  |  | Rec (Record) Button                          |
| 7  |  | TV/VCR Selection Button                      |
| 8  |  | Still Advance Button                         |
| 9  |  | Programme Number Up and Down Buttons for VCR |
| 10 |  | FF (Fast Forward)/Cue Button                 |

Open the cover  
(Push down and Slide the cover out.)

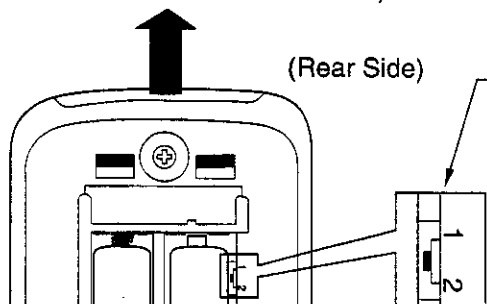











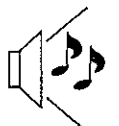
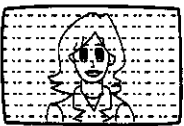

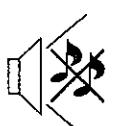
**VCR Mode Select Switch**

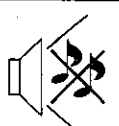
When used with normal Panasonic/National VCR's, set this switch to "2".  
If operation cannot be carried out, set the switch to "1".

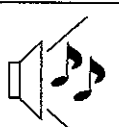
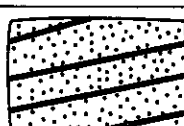
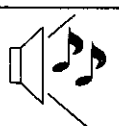

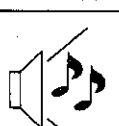
Before you call for service, determine the symptoms and make a few simple checks as shown below.

Symptoms		Checks
Picture	Sound	
 <p>Snowy Picture</p>	 <p>Noisy Sound</p>	Aerial Location, direction or Connections
 <p>Multiple Image</p>	 <p>Normal Sound</p>	Aerial Location, direction or Connections
 <p>Interference</p>	 <p>Noisy Sound</p>	Electrical Appliances Cars/Motorcycles Fluorescent Lamps
 <p>Normal Picture</p>	 <p>No Sound</p>	Volume (Check whether the mute function has been activated on the Remote Control.)
 <p>No Picture</p>	 <p>No Sound</p>	Not plugged into AC outlet Not switched on Contrast and Brightness/Volume setting (Check by pushing the Power Switch or Stand-by Button on the Remote Control.)
 <p>No Colour</p>	 <p>Normal Sound</p>	Colour Control
 <p>Scrambled</p>	 <p>Normal or Weak Sound</p>	Retune Channels
 <p>Coloured Patches</p>	 <p>Normal Sound</p>	<ul style="list-style-type: none"> <li>• Geomagnetism Correction (Refer to page 9)</li> <li>• Magnetic interference from unshielded equipment TV set moved while "ON" Turn the TV set off for 30 mins, using the "Power" Switch on the TV set.</li> </ul>
 <p>No Colour</p>	 <p>Noisy Sound</p>	Sound System (Refer to page 32) Colour System (Refer to page 33)

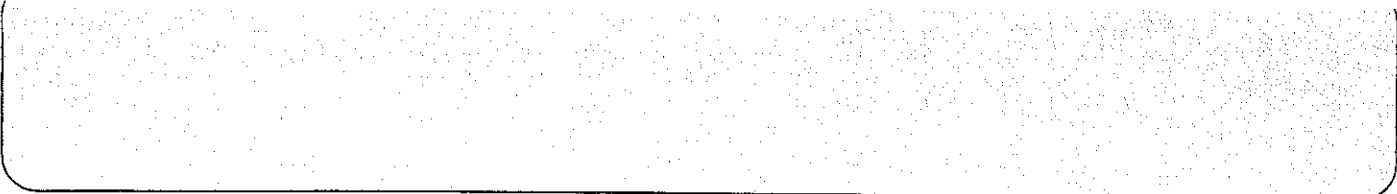

**Power Source**

AC 110-240 V, 50/60 Hz

**Power Consumption**

Type 28

190 W

Stand-by condition 3 W

Type 32

200 W

Stand-by condition 3 W

**Receiving System**

21 Systems		Function
1	PAL B, G, H	Reception of broadcast transmissions and Playback from Video Cassette Tape Recorders
2	PAL I	
3	PAL D, K	
4	SECAM B, G	
5	SECAM D, K	
6	SECAM K1	
7	NTSC M (NTSC 3.58/4.5 MHz)	
8	NTSC 4.43/5.5 MHz	Playback from Special VCR's
9	NTSC 4.43/6.0 MHz	
10	NTSC 4.43/6.5 MHz	
11	NTSC 3.58/5.5 MHz	
12	NTSC 3.58/6.0 MHz	
13	NTSC 3.58/6.5 MHz	
14	SECAM I	Playback from Special Disc Players and Special VCR's
15	PAL 60 Hz/5.5 MHz	
16	PAL 60 Hz/6.0 MHz	
17	PAL 60 Hz/6.5 MHz	
18	SECAM 60 Hz/5.5 MHz	
19	SECAM 60 Hz/6.0 MHz	
20	SECAM 60 Hz/6.5 MHz	
21	NTSC 50 Hz/4.5 MHz	

**Receiving Channels**

Regular TV

**VHF BAND**

2-12 (PAL/SECAM B, K1)

0-12 (PAL B AUST.)

1-9 (PAL B N.Z)

1-12 (PAL/SECAM D)

1-12 (NTSC M Japan)

2-13 (NTSC M U.S.A.)

**UHF BAND**

21-69 (PAL G, H, I/SECAM G, K, K1)

28-69 (PAL B AUST.)

13-57 (PAL D, K)

13-62 (NTSC M Japan)

14-69 (NTSC M U.S.A.)

**CATV**

S1-S20 (OSCAR) S21-S41 (HYPER)

1-125 (U.S.A. CATV) Z1-Z37 (CHINA)

C13-C49 (JAPAN) 5A, 9A (AUST.)

## Tuning System

Frequency synthesizer  
Auto Search Tuning  
POS (Position) : 100 Position  
DIRECT : 125 Position

## Picture Tube

	Type 28	Type 32
Overall Picture tube measured diagonally	71 cm	81 cm
Viewable Picture tube measured diagonally	66 cm	76 cm
CRT Deflection	106 °	106 °

## Audio Output

33 W (10 W + 10 W + 13 W)

## Headphones

Impedance 8 Ω

## Aerial Impedance

75 Ω Unbalanced coaxial

## Video/Audio Terminals

AV 1, 2, 3	S1-Video In	Y: 1.0 Vp-p, 75 Ω C: 0.3 Vp-p, 75 Ω
	Video In	1 Vp-p, 75 Ω
	Audio In	Approx. 400 mV 47 KΩ
Monitor Out	Video Out	1 Vp-p, 75 Ω
	Audio Out	Approx. 400 mV 1 KΩ
Surround Terminals	8~16 Ω	
Impedance		
3D Woofer Impedance	6 Ω	

## Accessories Supplied

3D Woofer Speaker  
Remote control Transmitter (TNQE007)  
R6 (AA) Battery × 2

## Optional Accessories

	Type 28	Type 32
Set Stand	TY-S28WG10G	TY-S32WG15G

## Dimensions (W × D × H with 3D Woofer 32 mm)

Type 28	Type 32
705 mm × 476 mm × 524 mm	800 mm × 523 mm × 581 mm

## Weight (Mass)

Type 28	Type 32
41.0 kg (Net)	54.0 kg (Net)

**Note:**  
Design and Specifications are subject to change without notice.  
Weight and Dimensions shown are approximate.

**Customer's Record**

The model number and serial number of this product can be found on its rear cover. You should note this serial number in the space provided below and retain this book plus your purchase receipt as a permanent record of your purchase to aid in identification in the event of theft or loss, and for Warranty Service purposes.

Model Number \_\_\_\_\_

Serial Number \_\_\_\_\_

---

**Matsushita Electric Industrial Co., Ltd.**

Central P.O. Box 288, Osaka 530-91, Japan

Printed in Japan  
S1095