

Panasonic

Operating Instruction

Colour Television
TC-51PM10ZQ

Please read the operating instructions completely before operating this set.

TQB4G2053 (A)

Dear Panasonic customer

Welcome to the Panasonic family of customers. We hope that you will have many years of enjoyment from your new colour television.

Safety Instructions

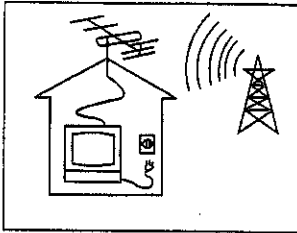

The TV set can be operated on AC AUTO 110-240V, 50/60Hz.

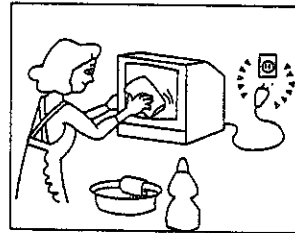

The cabinet and picture tube can be kept in good condition by simply wiping with a clean, soft cloth moistened with mild detergent and water. Do not use solutions containing benzol, petroleum or a chemical cloth. For safety, remove the plug from the wall outlet.

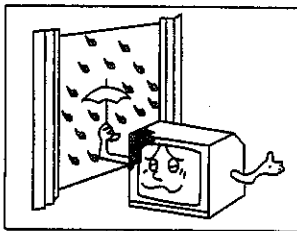

To prevent damage which may result in fire or electrical shock, do not expose the TV set to rain or excessive moisture.

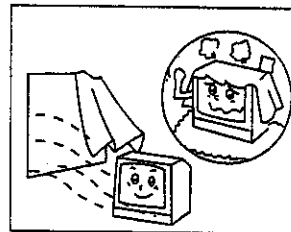

Adequate ventilation is essential to prevent failure of electrical components.

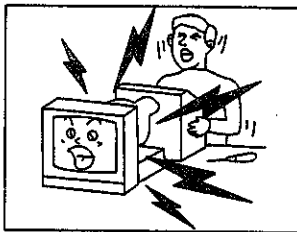

Do not remove the rear cover, as live parts are accessible when it is removed.

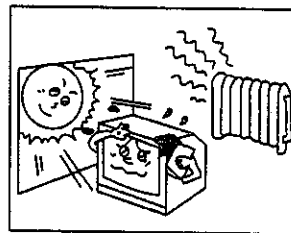

Avoid exposing the TV set to direct sunlight and other source of heat.

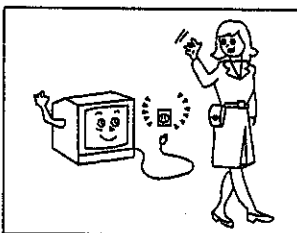

Remove the plug from the wall outlet (Power point) when the TV set is not used for a prolonged period of time.

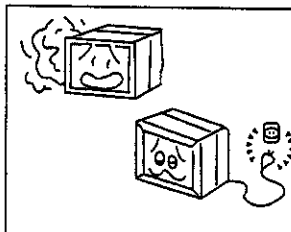

Do not use this set if abnormal operation occurs.
EX: smoke, odd sounds or smells, turn the power switch off and disconnect the AC power if you notice any unusual operation.

Before Operating This Set

Connect the Aerial Cable to the RF In Terminal

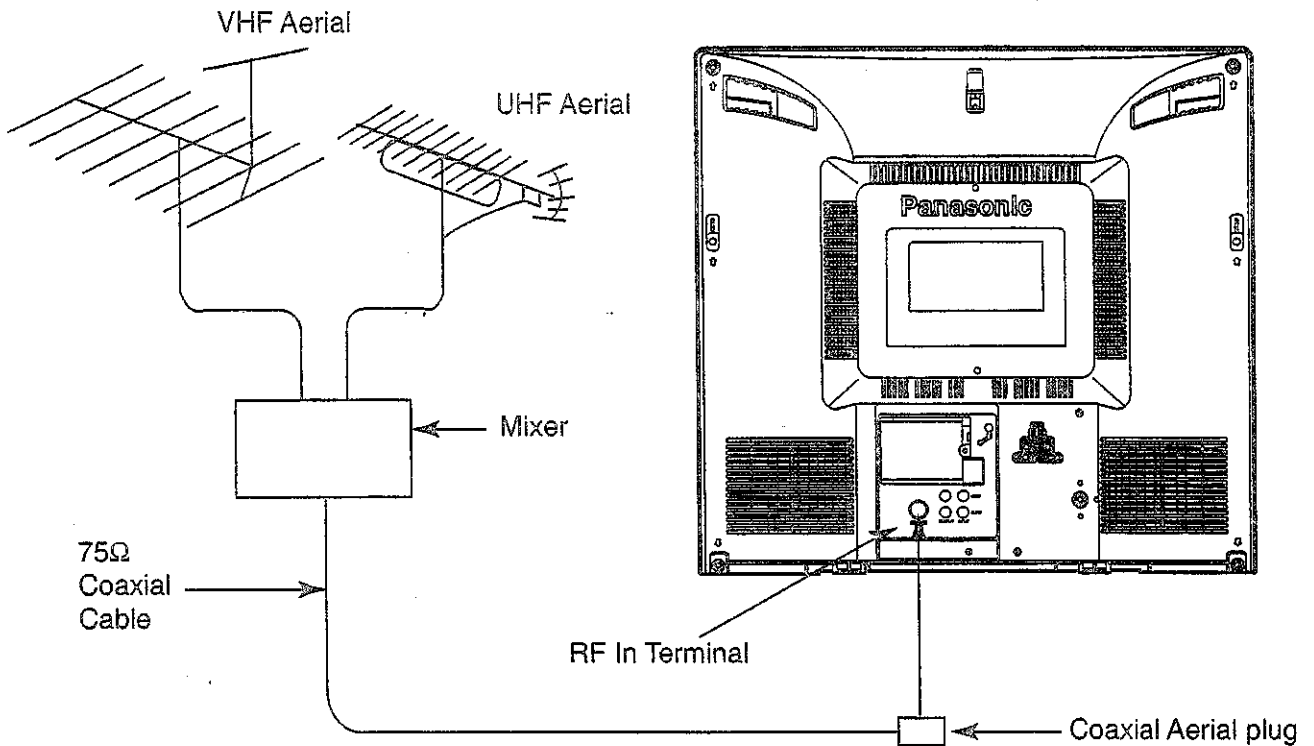

To obtain the best quality picture and sound, an external antenna, the correct cables (75 Ohm coaxial) and the correct terminating plug will be required.

If a communal antenna system is used, you may require the correct connection cable and plugs between the wall antenna socket and your television receiver.

Your local Television Service Dealer may be able to assist you in obtaining the correct antenna system for your particular area and accessories required.

Any matters about antenna installation, upgrading of existing systems or accessories required, and the cost incurred, are the responsibility of the customer.

Note :

If your existing antenna system uses 300 Ohm to 75 Ohm Balun, see Below.

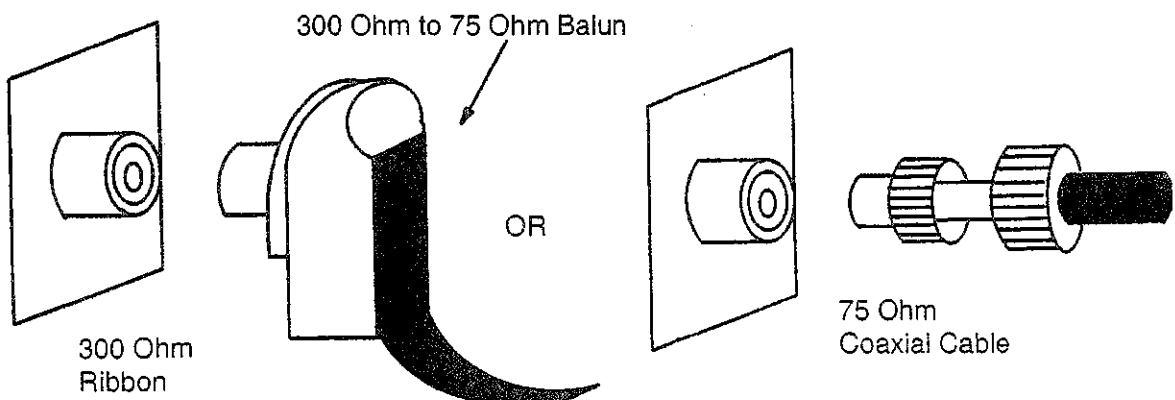

Before Operating This Set

Battery Installation

1

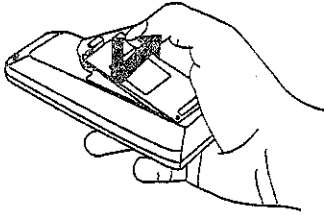

Open the cover.

Push bottom downward and pull out the cover.

2

Two "R6 (AA)" size

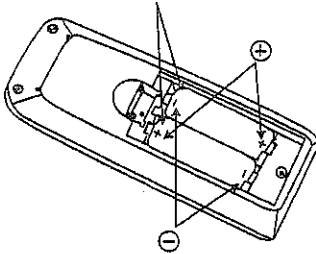

Batteries: Use two "R6 (AA)" size batteries.

Insert the batteries ensuring correct polarity.

This is identifiable by the "+" and "-" symbols on both the batteries and inside the battery compartment.

3

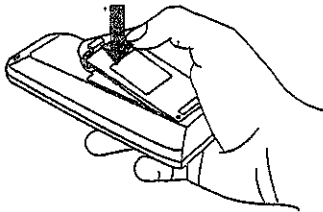

Replace the cover.

Do not use rechargeable (Ni-Cd) batteries.

They are different in shape and performance and may fail to ensure correct operation.

Battery cautions

The incorrect use of batteries can cause electrolyte leakage which will corrode the Remote Control or cause the batteries to burst.

Old Batteries

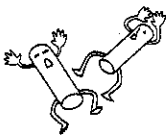

New Batteries



Replacement both batteries at the same time.



Don't mix battery types
(alkaline with carbon zinc, etc.)

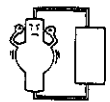

Don't Recharge.

Connections (Audio Input and Video Input)

To watch the VCR picture :

Connect the VCR cable to the AUDIO INPUT and VIDEO INPUT terminals at the rear of TV.

Press the TV/AV selection button, set the VCR to the playback mode. To watch or to return to the TV programme, press the TV/AV selection button again.

Note:

If both AV IN terminals are connected at the same time, only front AV input terminal can operate.

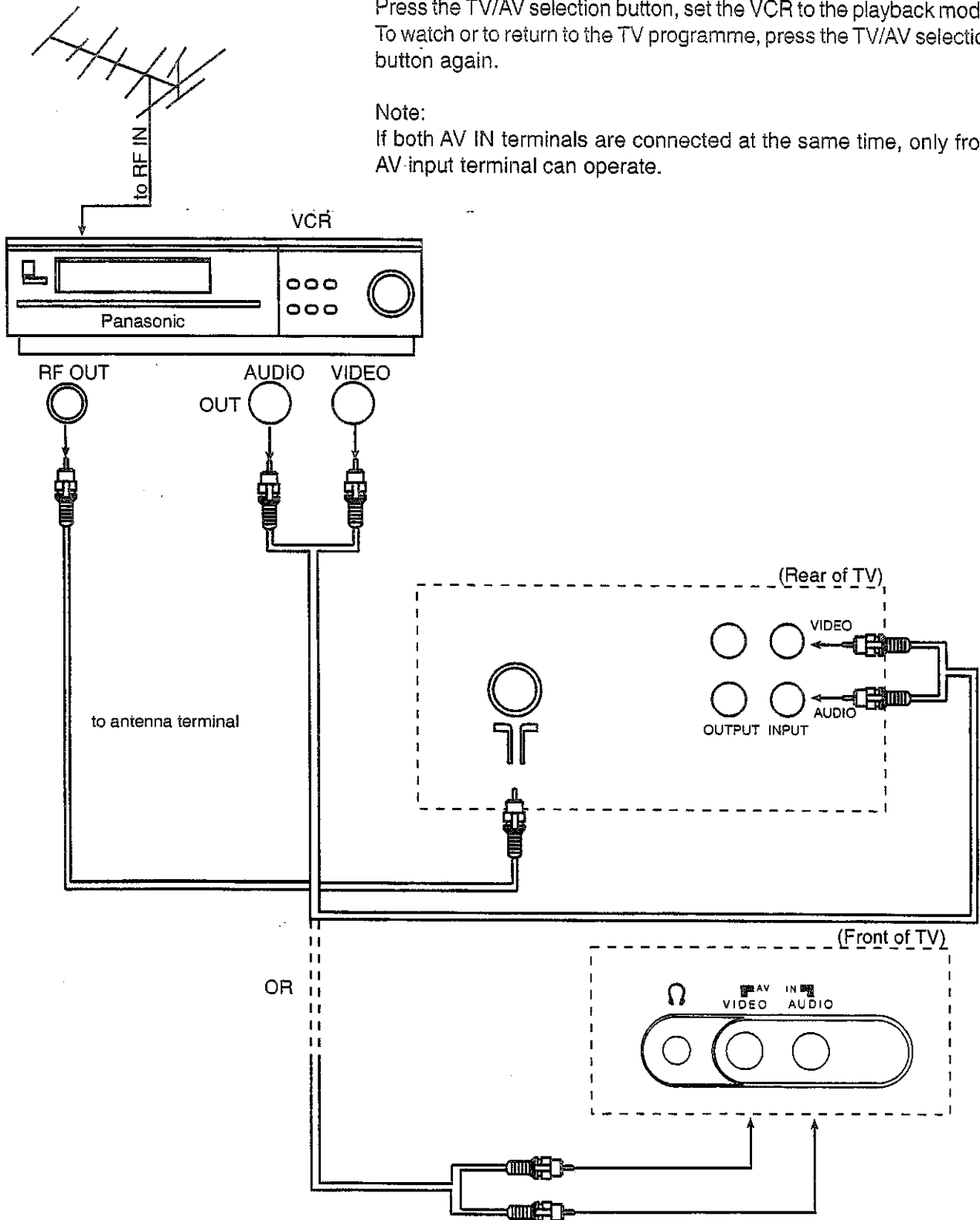

Recording

Follow the connection shown below when you want to copy a programme from another tape (VCR). You can either use the AV input at the back or the front of the TV.

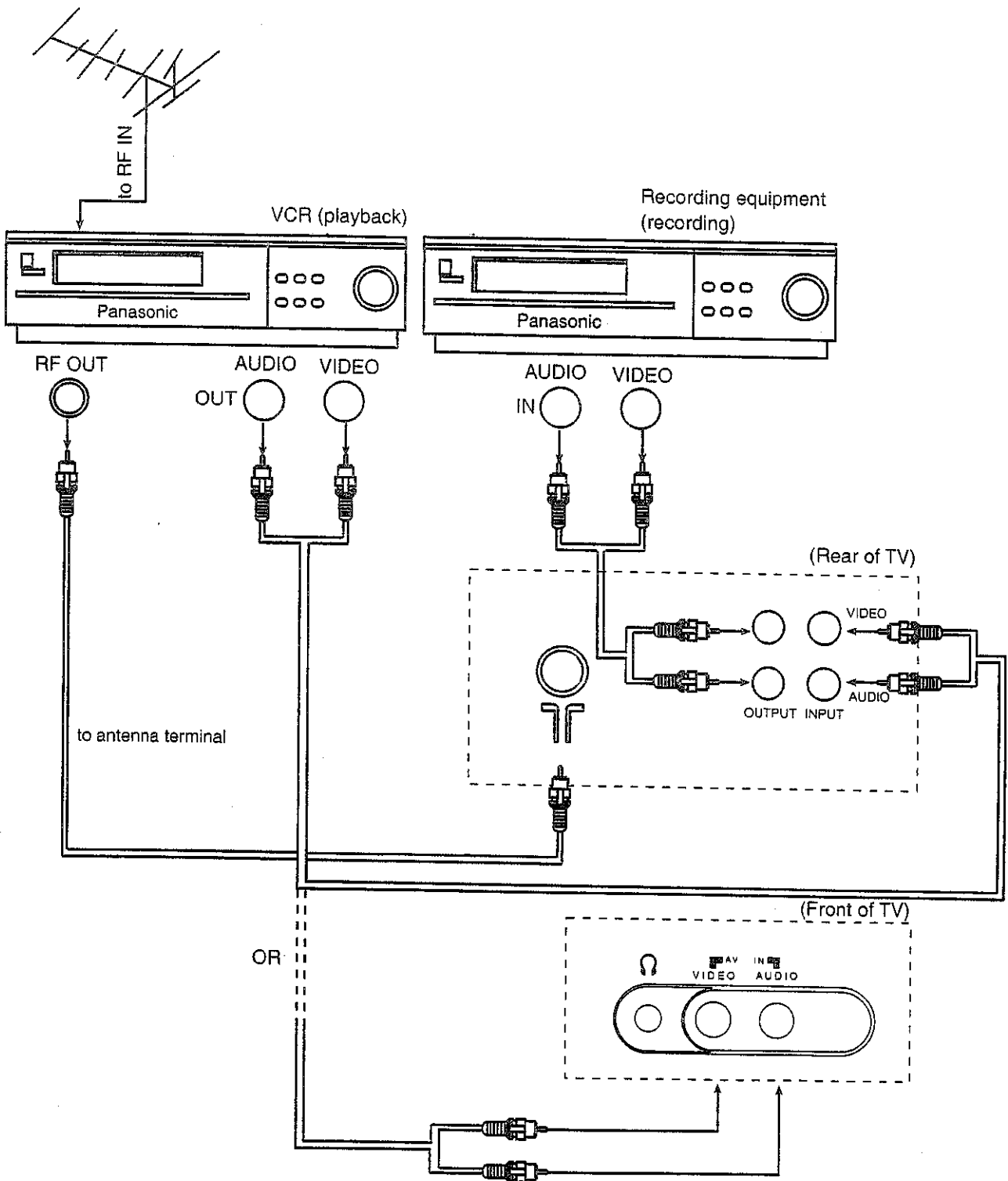

Location of Control (TV)

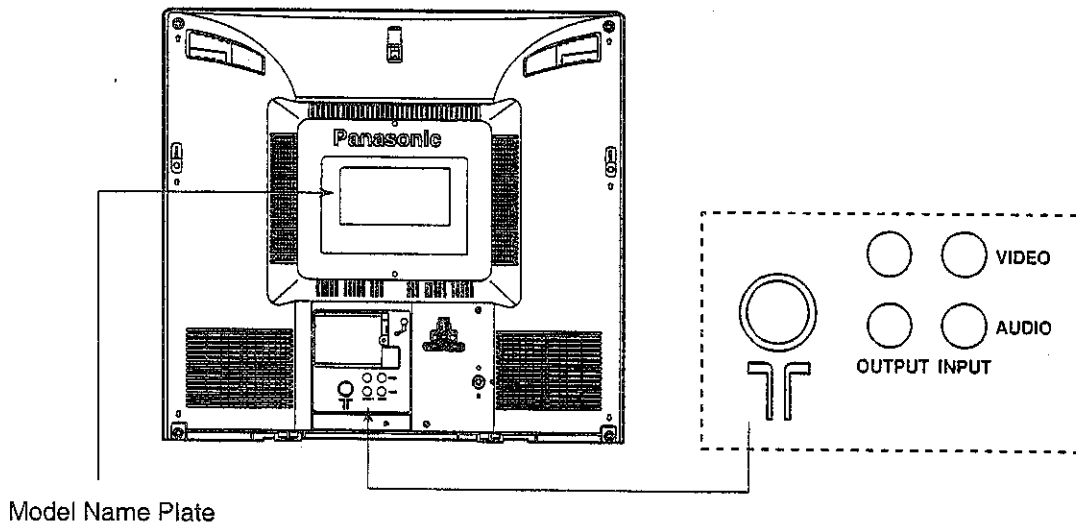
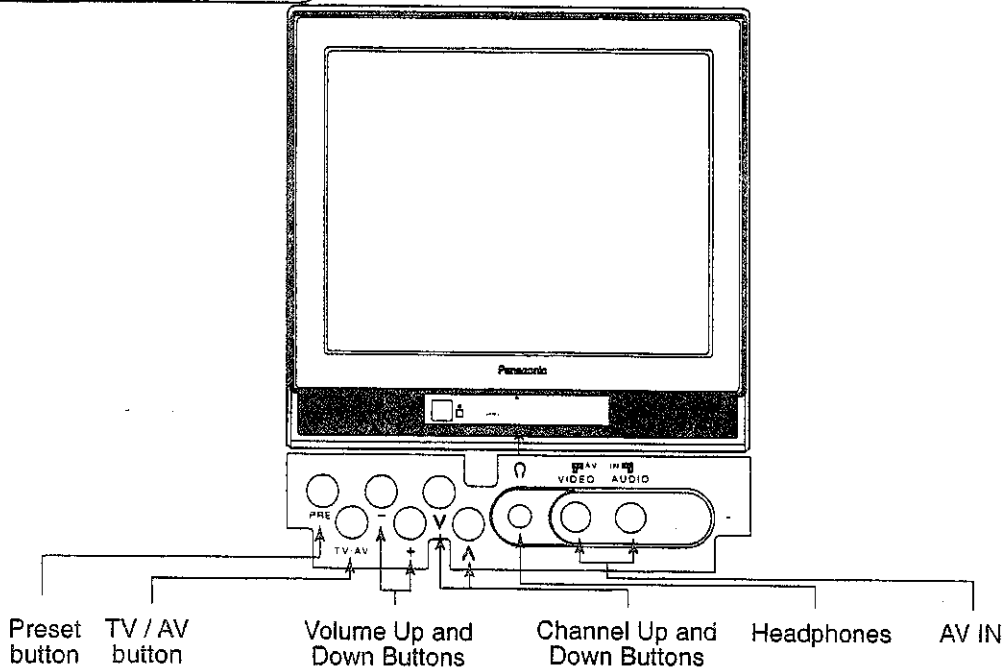





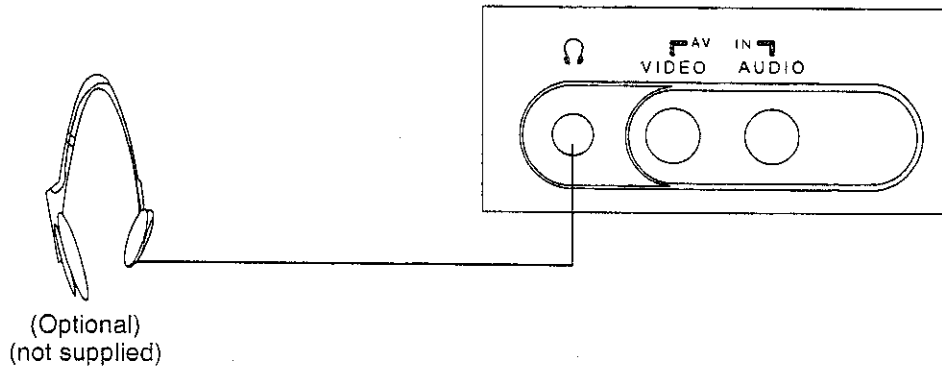



Connecting Headphones

When a headphones plug is inserted into the Headphones socket all speakers will be automatically disconnected; only the Headphones will function.



Flow Chart of Main Menu

When the "MAIN MENU" button is pushed at the main menu screen, the screen display will return to the normal viewing condition. When the "MAIN MENU" button is pushed at each MENU screen (Picture, Sound, Features, Language, Preset), the screen display will return to the Main Menu screen.

Push	MAIN MENU 				
Select	 				
Symbol Mark					
On-Screen Indication	PICTURE	SOUND	FEATURES	LANGUAGE ENGLISH #X РУССКИЙ العربية	PRESET
Push	▼	▼	▼	▼	▼
On-Screen Indication (example)	<p>PICTURE</p> <p>MENU DYNAMIC</p> <p>32 COLOUR</p> <p>32 NTSC-TINT</p> <p>32 BRIGHT</p> <p>63 CONTRAST</p> <p>32 SHARPNESS</p> <p>COLOUR TEMP. STD</p>	<p>SOUND</p> <p>24 TONE</p>	<p>FEATURES</p> <p>BLUE BACK ON</p> <p>CH COLOUR SET STD</p> <p>CHILD LOCK OFF</p> <p>VCR/GAME OFF</p>	<p>ENGLISH</p> <p>#X</p> <p>РУССКИЙ</p> <p>العربية</p>	<p>PRESET</p> <p>AUTO TUNE</p> <p>MANUAL TUNE</p> <p>SOUND SYS 5.5MHz</p> <p>COLOUR SYS AUTO</p> <p>FINE TUNE</p> <p>SKIP OFF</p> <p>POS. CHANGE 1</p>
	▲		▲	▲	▲
	<p>PICTURE</p> <p>MENU DYNAMIC</p> <p>32 COLOUR</p> <p>32 NTSC-TINT</p> <p>32 BRIGHT</p> <p>63 CONTRAST</p> <p>32 SHARPNESS</p> <p>COLOUR TEMP. STD</p>		<p>FEATURES</p> <p>BLUE BACK ON</p> <p>CH COLOUR SET STD</p> <p>CHILD LOCK OFF</p> <p>VCR/GAME OFF</p>	<p>ЯЗЫК</p> <p>ENGLISH</p> <p>#X</p> <p>РУССКИЙ</p> <p>العربية</p>	<p>PRESET</p> <p>AUTO TUNE</p> <p>MANUAL TUNE</p> <p>SOUND SYS 5.5MHz</p> <p>COLOUR SYS AUTO</p> <p>FINE TUNE</p> <p>SKIP OFF</p> <p>POS. CHANGE 1</p>
	▲		▲	▲	▲
	<p>PICTURE</p> <p>MENU DYNAMIC</p> <p>32 COLOUR</p> <p>32 NTSC-TINT</p> <p>32 BRIGHT</p> <p>63 CONTRAST</p> <p>32 SHARPNESS</p> <p>COLOUR TEMP. STD</p>		<p>FEATURES</p> <p>BLUE BACK ON</p> <p>CH COLOUR SET STD</p> <p>CHILD LOCK OFF</p> <p>VCR/GAME OFF</p>	<p>اللغة</p> <p>ENGLISH</p> <p>#X</p> <p>РУССКИЙ</p> <p>العربية</p>	<p>PRESET</p> <p>AUTO TUNE</p> <p>MANUAL TUNE</p> <p>SOUND SYS 5.5MHz</p> <p>COLOUR SYS AUTO</p> <p>FINE TUNE</p> <p>SKIP OFF</p> <p>POS. CHANGE 1</p>
	▲		▲	▲	▲
	<p>PICTURE</p> <p>MENU DYNAMIC</p> <p>32 COLOUR</p> <p>32 NTSC-TINT</p> <p>32 BRIGHT</p> <p>63 CONTRAST</p> <p>32 SHARPNESS</p> <p>COLOUR TEMP. STD</p>		<p>FEATURES</p> <p>BLUE BACK ON</p> <p>CH COLOUR SET STD</p> <p>CHILD LOCK OFF</p> <p>VCR/GAME OFF</p>		<p>PRESET</p> <p>AUTO TUNE</p> <p>MANUAL TUNE</p> <p>SOUND SYS 5.5MHz</p> <p>COLOUR SYS AUTO</p> <p>FINE TUNE</p> <p>SKIP OFF</p> <p>POS. CHANGE 1</p>
	▲		▲		▲
	<p>PICTURE</p> <p>MENU DYNAMIC</p> <p>32 COLOUR</p> <p>32 NTSC-TINT</p> <p>32 BRIGHT</p> <p>63 CONTRAST</p> <p>32 SHARPNESS</p> <p>COLOUR TEMP. STD</p>				<p>PRESET</p> <p>AUTO TUNE</p> <p>MANUAL TUNE</p> <p>SOUND SYS 5.5MHz</p> <p>COLOUR SYS AUTO</p> <p>FINE TUNE</p> <p>SKIP OFF</p> <p>POS. CHANGE 1</p>
	▲				▲
	<p>PICTURE</p> <p>MENU DYNAMIC</p> <p>32 COLOUR</p> <p>32 NTSC-TINT</p> <p>32 BRIGHT</p> <p>63 CONTRAST</p> <p>32 SHARPNESS</p> <p>COLOUR TEMP. STD</p>				<p>PRESET</p> <p>AUTO TUNE</p> <p>MANUAL TUNE</p> <p>SOUND SYS 5.5MHz</p> <p>COLOUR SYS AUTO</p> <p>FINE TUNE</p> <p>SKIP OFF</p> <p>POS. CHANGE 1</p>
	▲				▲
	<p>PICTURE</p> <p>MENU DYNAMIC</p> <p>32 COLOUR</p> <p>32 NTSC-TINT</p> <p>32 BRIGHT</p> <p>63 CONTRAST</p> <p>32 SHARPNESS</p> <p>COLOUR TEMP. STD</p>				<p>PRESET</p> <p>AUTO TUNE</p> <p>MANUAL TUNE</p> <p>SOUND SYS 5.5MHz</p> <p>COLOUR SYS AUTO</p> <p>FINE TUNE</p> <p>SKIP OFF</p> <p>POS. CHANGE 1</p>

General Operation

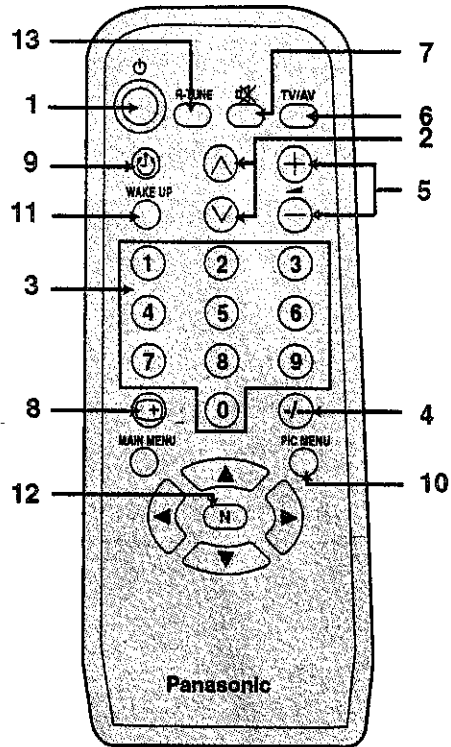

1.

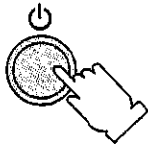

To Switch Power on/off

The TV set must be switched on at the wall outlet and at the Main power switch. Press this button to turn the TV set ON, from stand-by mode. Press it again to turn off.

Note:

When in the stand-by condition, it is possible to turn the TV set on by pushing the Direct Programme Number Selection button (0-9) or the Programme Number up and Down button.

2.

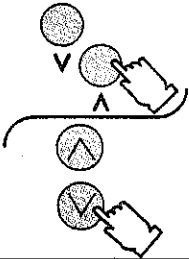

Programme Number Selection

Press the programme number Up "▲" or down "▼" Button to select the next higher or lower programme number.

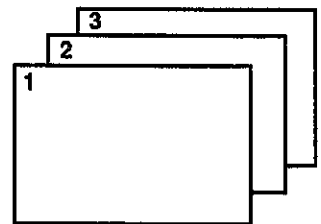

3.

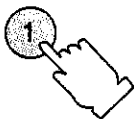

Direct Programme Number Selection

(0 - 9)

e. g. To select programme number "1", press the "1" button.



4.

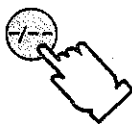

Two Digit Programme Number Selection

e.g. To select Programme Number "24".

Push the button.

Push the button.

Push the button.

Setting range	0 ~ 99
---------------	--------

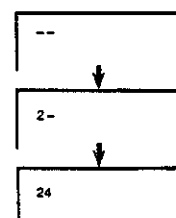

General Operation

5.

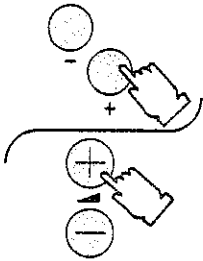

Volume Adjustment

Push the Volume Up or Down button to increase or decrease the sound volume level.

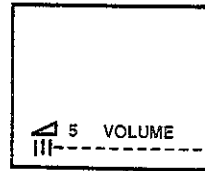

6.

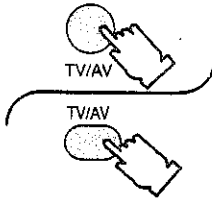

TV / AV Selection

Push the "TV/AV" button to select TV and AV input signal modes sequentially.

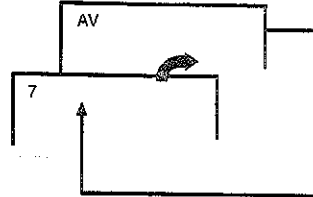

7.

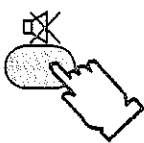

Sound Mute Button

Push this button to mute the Sound completely.
Push the button once again to restore the previous sound level, and cancel the mute.

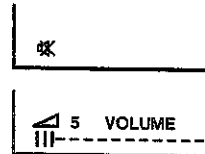

The "Mute" symbol will appear.
(Colour changes to Red)

8.

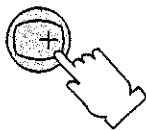

Recall Button

Push the RECALL button to display the current system status. Press this button until display is cancelled.

9.



Off Timer Button

The TV set may be preset to switch to stand-by after a fixed period.
By pressing "Off-Timer" button, you can select the preset time either 30, 60, or 90 minutes.

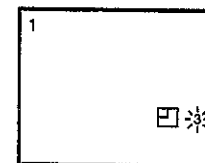
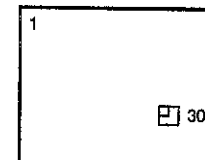
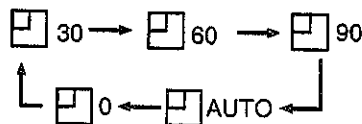

When the off-timer reaches its last 3 minutes, it starts blinking before going to stand-by condition.

Note :

Setting Off-timer to AUTO mode. If the set is not switched off, when the TV station ends broadcasting, it will automatically go to the stand-by condition after 5 minutes. This AUTO mode will not operate when the TV receiver is in AV mode.

How to cancel the OFF-timer setting:

1. Set the preset time condition to "0" mode by pressing the Off -timer button.
2. Turning the TV set off.

General Operation

10. PIC MENU



Picture Menu Operation

By pressing the PICTURE MENU button, you can sequentially select the Picture menus as shown below:

On-screen	Function
MENU DYNAMIC	For watching in brighter environments. This menu selects a higher than normal level of contrast.
MENU STANDARD	For watching in normal (evening) environments. This menu selects normal level of contrast.
MENU SOFT	For watching in dark environments. This menu selects reduced level of contrast.

11. WAKE UP

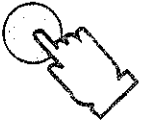

Wake Up Timer Button

1. Press the " WAKE UP TIMER" button.
2. Press the position left or right button to select the wake up timer. (Wake up timer will increase or decrease by 10 minutes when left or right button is pressed.)

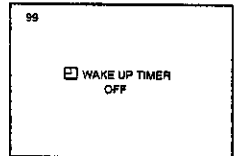

Note :

Wake up time can be set up to 12 hours.

3. After setting the wake up timer, switch the TV set to stand-by mode. (LED light will blink ON and OFF during stand-by mode)
4. When the time Wake Up timer has elapsed in the set will automatically switch on. (Press any button to cancel the Wake Up timer on screen display.)

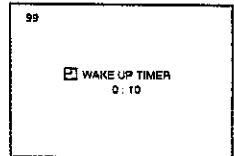

Note :

- i) After the Wake Up time is set and the TV mode is still not switched off, the Wake Up timer will continue to count down until the timer is off.
 - ii) When Wake Up timer switch ON the TV set, the off timer is set to 90 minutes mode automatically. Press any button to cancel the off-timer. If no button is pressed, the TV set will switch off automatically after 90 minutes.
5. To cancel the Wake Up timer.
You can choose any of the following:
 - i) Switch off the main power.
 - ii) Press the position left or right button, until OFF is reached.
 - iii) Press the NORMALIZE button when Wake Up timer OSD is displayed.

General Operation

12. Normal (N) Button

By pushing the Normal "N" button on the Remote Control while Picture or Sound Control Function is displayed, the selected function will be changed to the Normal Mode. Normalization will not occur if the function is not displayed when the "N" button is pushed. The Normal mode is the factory preset condition. Returning to this original condition is called "Normalization".

13. R-TUNE Rapid Tune Button

Push the button to access previously viewed channel.

PRESENT CHANNEL
BEING VIEWED



LAST VIEWED
CHANNEL



Tuning Procedure

Automatic Tune

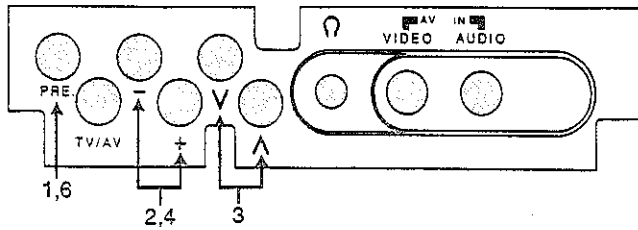

OR

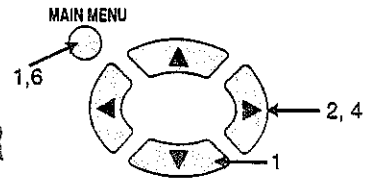

1. Press the "PRE" (PRESET) button, until "AUTO TUNE" function is selected.

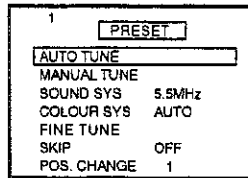

Channel Number
Automatic Tune condition.

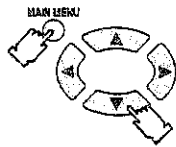

Press the "MAIN MENU" and "Position" buttons, until "AUTO TUNE" function is selected.

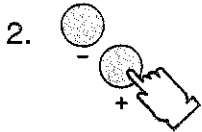

2. Press the Volume Up "+" or Down "-" button.

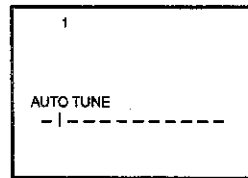

Search start.
The best tuning position is automatically memorized.

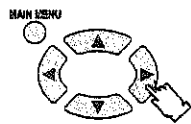

Press the Position Right button.

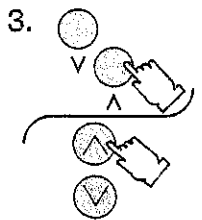

3. After all stations are tuned, the on-screen display will automatically change from "AUTO TUNE" to "SOUND SYS" Position. Confirm the sound condition of each Programme Number by using the Programme Number "∧" Button.

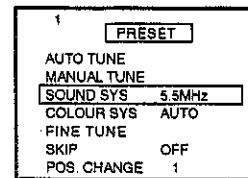

If the Sound is not clear or no sound is produced on a Programme Number, then follow the next Step 4.

Note:
When sound volume is too small to confirm, turn it up by using the sound volume button on the remote control

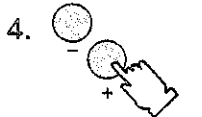

4. If necessary, press the Volume Up "+" or Down "-" Button, to improve the Sound quality.

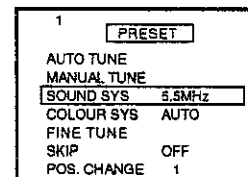

The sound indicator will change as follows:

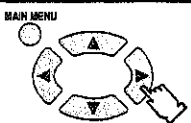
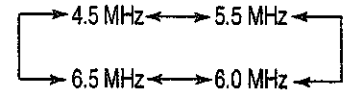

Press the Position Left or Right button to improve the sound quality.



5. Use the Programme Number Up "∧" button to sequentially check each station. If necessary repeat step 3 to 4 for each Programme Number.



6. Press the "PRE" (PRESET) button 5 times.

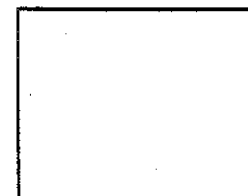

This returns the set to the normal viewing condition.

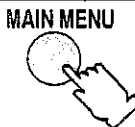

After all stations are tuned, press the "MAIN MENU" button twice.

Tuning Procedure

Manual Tune

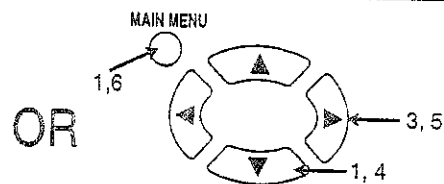
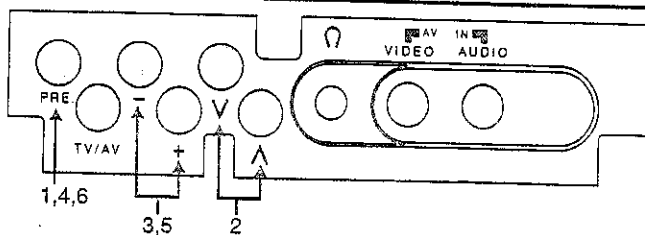

1. Press the "PRE" (PRESET) button twice, setting the Manual Tune mode.

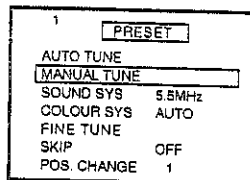

Channel Number
Manual Tune condition.



Press the "MAIN MENU" and "Position" buttons, until "MANUAL TUNE" function is selected.

2. Press either the Channel Up or Down button.

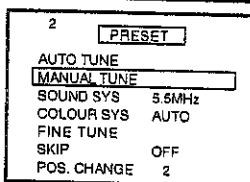
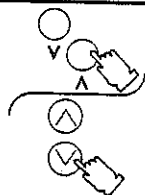

Select the desired
Channel Number.

3. Press the Volume Up "+" or Down "-" button.
Volume "+": Next higher Channel
Volume "-": Next lower Channel

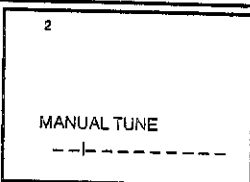
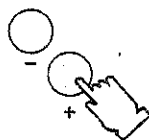

Search Start.

Press the Position Left or Right button.
Position left: Next lower Channel.
Position right: Next higher Channel.

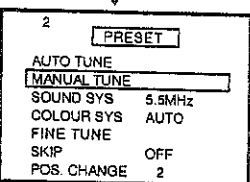
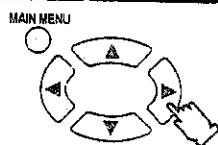

The best tuning position is
automatically memorized.

4. Press the "PRE." (PRESET) button.

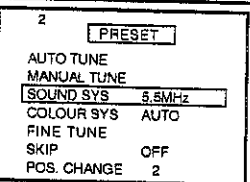

"SOUND SYS" Condition.



Press the "Position" button until
"SOUND SYS" function is selected.

5. If the sound is not clear or no sound is produced on a Programme Number Position, press the Volume Up "+" or Down "-" Button.

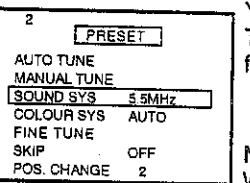
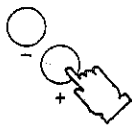

You may improve the Sound quality.
The sound indicator will change as follows.

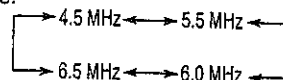

Note:
When sound volume is too small to confirm, turn it up by using the sound volume button on the remote control.

6. Press the "PRE" (PRESET) button 5 times.

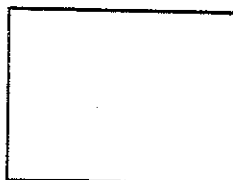

This returns the set to the
normal viewing condition.

Press the "MAIN MENU" button twice.

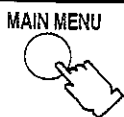

Tuning Procedure

Fine Tune

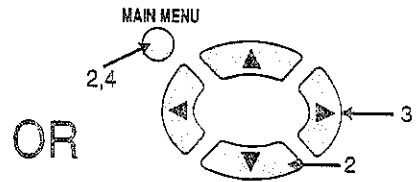
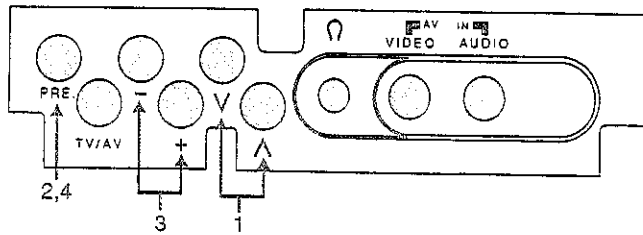

Under normal reception condition, this function is not used. However, in areas of poor reception or constant interference, a slight adjustment on the fine tuning can improve the picture and sound quality.

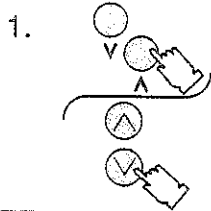

Select the channel which you want to try to improve, using the Channel Up or Down buttons.

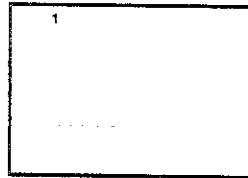

Select the desired Channel Number.

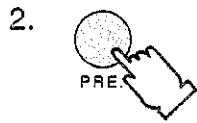

Press the "PRE." (PRESET) buttons 5 times, setting the Preset Menu to "Fine Tune".

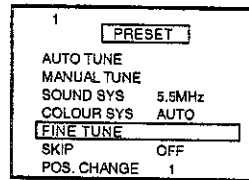

Fine Tune condition.

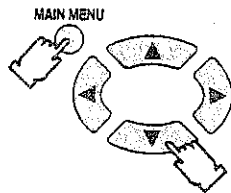

Press the "MAIN MENU" and "Position" buttons, until "FINE TUNE" is selected.

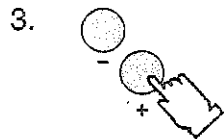

Press the Volume Up "+" or Down "-" button until the clear picture is received.

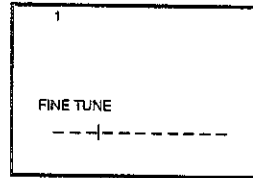

Fine Tune Start.

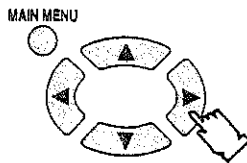

Press the Position Left or Right button until the clear picture is received.

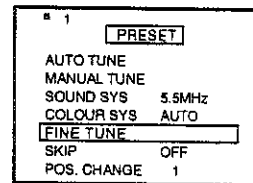

The AFC function is deactivated. The "■" symbol appears to the left of the Channel Number.



Press the "PRE" (PRESET) button 3 times.

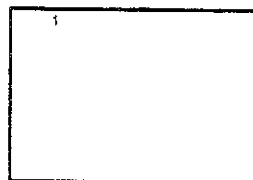

This returns the set to the normal viewing condition.

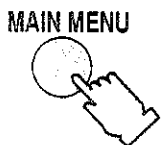

After all stations are tuned, press the "MAIN MENU" button twice.

Tuning Procedure

How to cancel the Fine Tuning

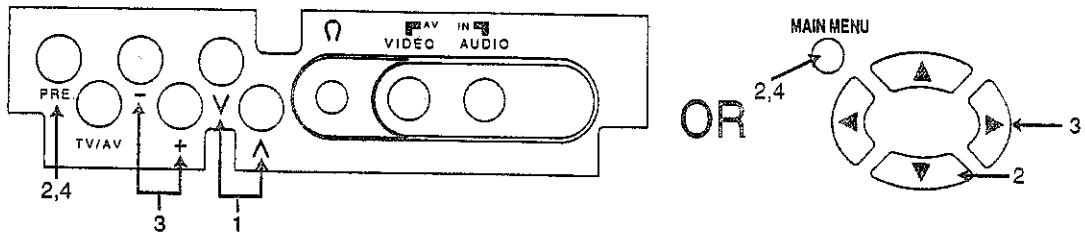

Cancelling previously adjusted (manually) fine tuning, means reactivating the AFC (Automatic Frequency Control) Function, also known as AFT (Automatic Frequency Tuning). Reactivating the Automatic Fine Tuning means allowing the set to automatically tune optimum tuning position, for that Channel Number.

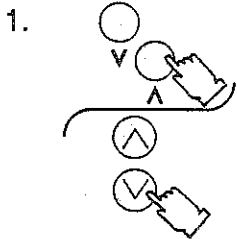

1. Select the "AFC OFF" Channel Number which you want to return to Automatic Frequency Control (Cancel the manual fine tuning).

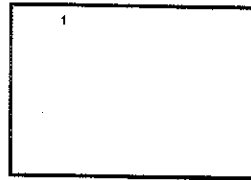

"AFC OFF" Channel Numbers are indicated to you by the "■" symbol to the left of the Channel Number.



2. Press the "PRE." (PRESET) buttons twice, setting the Preset Menu to set to "MANUAL TUNE" mode.

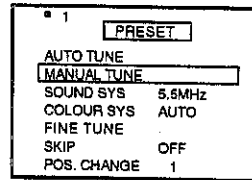

Manual Tune condition.

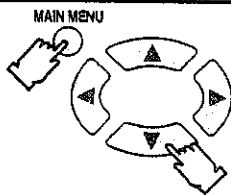

Press the "MAIN MENU" and "Position" buttons, until "MANUAL TUNE" function is selected.

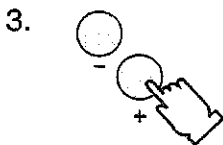

3. Press the Volume Up "+" or Down "-" button briefly.

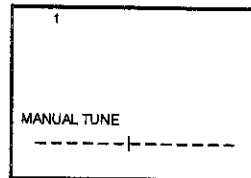

The best tuning position is automatically memorized.

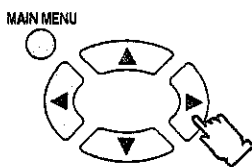

Press the Position Left or Right button briefly.

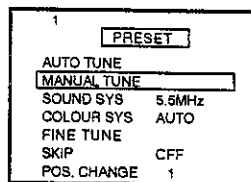

4. Press the "PRE" (PRESET) button 6 times.

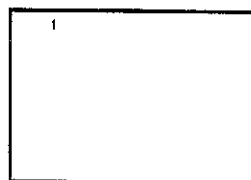

This returns the set to the normal viewing condition.

MAIN MENU



Press the "MAIN MENU" button twice.

Tuning Procedure

How to Skip Programme Number

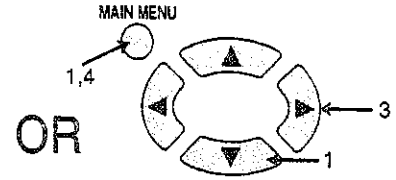
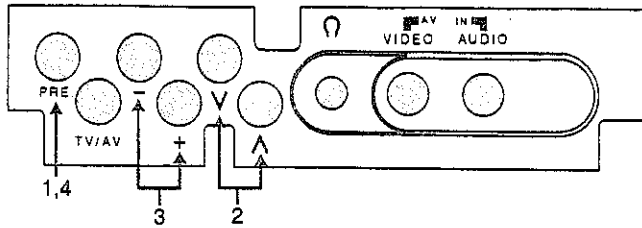

1. Press the "PRE." (PRESET) button 6 times, setting the Preset Menu to "SKIP".

1	PRESET
AUTO TUNE	
MANUAL TUNE	
SOUND SYS	5.5MHz
COLOUR SYS	AUTO
FINE TUNE	
SKIP	OFF
POS. CHANGE	1

Channel Skip condition.

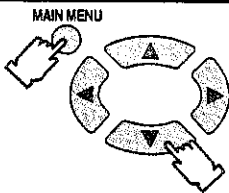

Press the "MAIN MENU" and "Position" buttons, until the Preset Menu to "SKIP".

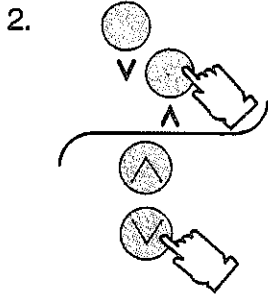

2. Select a Programme Number you want to skip, by pushing the Channel number Up or Down buttons.

2	PRESET
AUTO TUNE	
MANUAL TUNE	
SOUND SYS	5.5MHz
COLOUR SYS	AUTO
FINE TUNE	
SKIP	OFF
POS. CHANGE	2

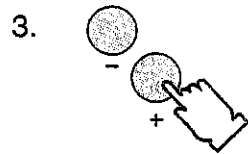

3. Press the Volume Up "+" or Down "-" button.

2	PRESET
AUTO TUNE	
MANUAL TUNE	
SOUND SYS	5.5MHz
COLOUR SYS	AUTO
FINE TUNE	
SKIP	ON
POS. CHANGE	2

The displayed "OFF" condition changes to "ON".

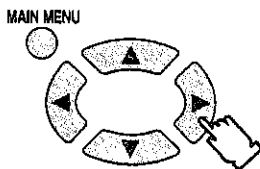

Press the Position Left or Right button.



4. Press the "PRE" button 2 times.



This returns the set to the normal viewing condition.

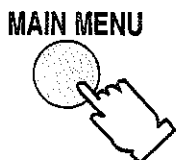

Press the "MAIN MENU" button twice.

Tuning Procedure

How to Cancel the Skip Function

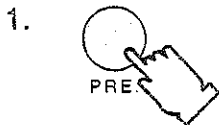
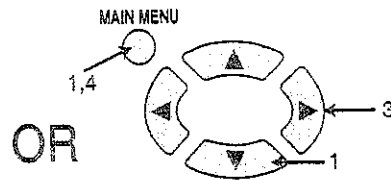
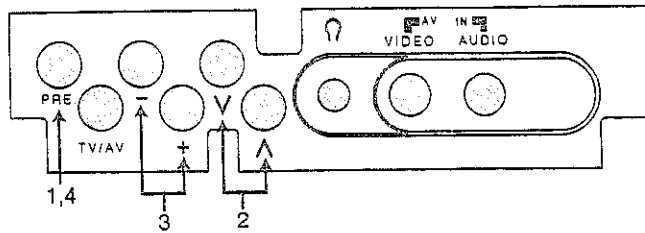

1. Press the "PRE." (PRESET) buttons 6 times, setting the Preset Menu to "SKIP".

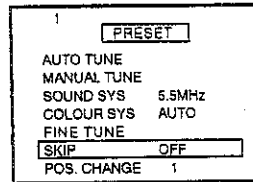

Channel Skip condition.

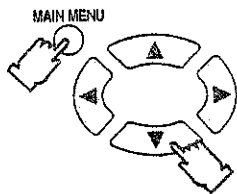

Press the "MAIN MENU" and "Position" buttons, until "SKIP" is selected.

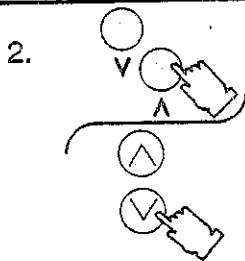

2. Select the skipped Programme Number, by pressing the Channel Number Up or Down buttons.

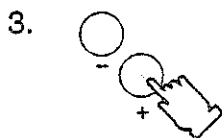
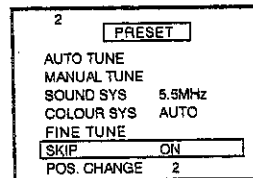

3. Press the Volume Up "+" or Down "-" button.

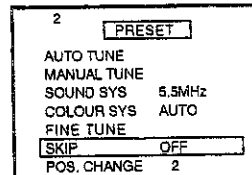

The displayed "ON" condition changes to "OFF".

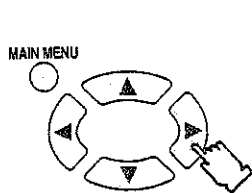

Press the Position Left or Right button.

Repeat step 2 and 3, if you wish to cancel the Skip function on any other programme number.

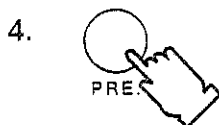

4. After the Skip Cancel operation is completed, press the "PRE" button twice.



This returns the set to the normal viewing condition.

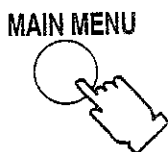

After the Skip Cancel Operation is completed, press the "MAIN MENU" button twice.

Tuning Procedure

Colour System Selection

Use this function if a clear picture with weak colour is obtained when a Broadcast or AV signal is received.

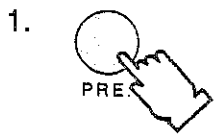
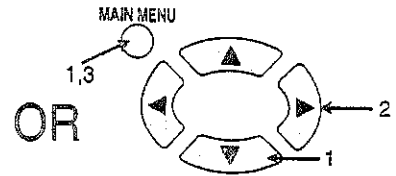
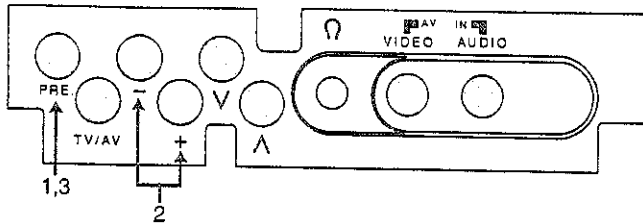

1. Press the "PRE." (PRESET) button 4 times.

1	PRESET
	AUTO TUNE
	MANUAL TUNE
	SOUND SYS 5.5MHz
	COLOUR SYS AUTO
	FINE TUNE
	SKIP OFF
	POS. CHANGE 1

Colour System condition.

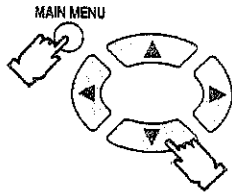

Press the "MAIN MENU" and "Position" buttons, until "COLOUR SYS" is selected.

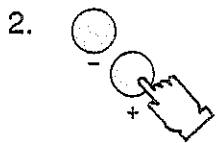

2. Press the Volume Up "+" or Down button, "-" repeatedly until the optimum image is produced.

1	PRESET
	AUTO TUNE
	MANUAL TUNE
	SOUND SYS 5.5MHz
	COLOUR SYS AUTO
	FINE TUNE
	SKIP OFF
	POS. CHANGE 1

The Colour system will change as shown:

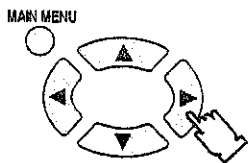

Press the Position Left or Right button repeatedly until the optimum image is obtained.

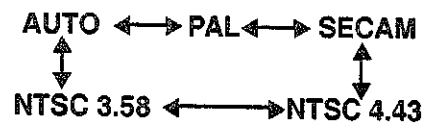

3. Press the "PRE" (PRESET) button 4 times.



This returns the set to the normal viewing condition.

This selected Colour System is automatically memorized.

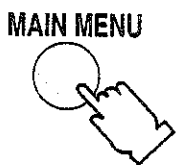



Press the "MAIN MENU" button twice.

Tuning Procedure

Sound System Selection

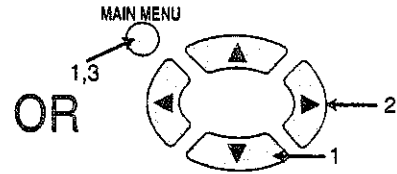
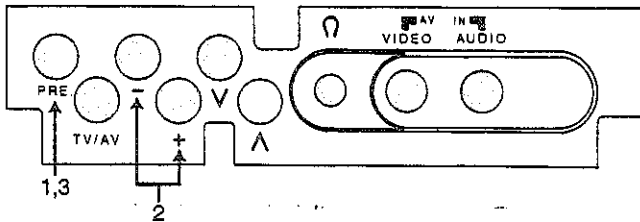
This function is used only in the TV mode, and is not applicable in AV mode.
When the sound is not clear or no sound is produced on a channel.



1.  Press the "PRE." (PRESET) button 3 times.

1	PRESET
	AUTO TUNE
	MANUAL TUNE
	SOUND SYS 5.5MHz
	COLOUR SYS AUTO
	FINE TUNE
	SKIP OFF
	POS. CHANGE 1

Sound System condition.

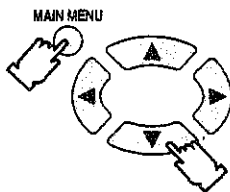
 Press the "MAIN MENU" and "Position" buttons, until "SOUND SYS" is selected.

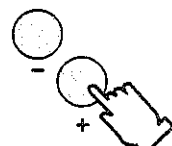
2.  Press the Volume Up "+" or Down button "-" repeatedly until the optimum sound is obtained.

1	PRESET
	AUTO TUNE
	MANUAL TUNE
	SOUND SYS 6.5MHz
	COLOUR SYS AUTO
	FINE TUNE
	SKIP OFF
	POS. CHANGE 1

The Sound system will change as shown:

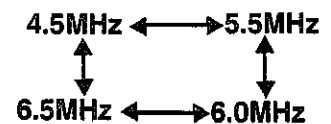

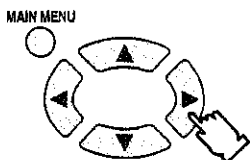
 Press the Position Left or Right button repeatedly until the optimum sound is obtained.

3.  Press the "PRE." (PRESET) button 5 times.



This returns the set to the normal viewing condition.

This selected Sound System is automatically memorized.

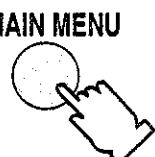
 Press the "MAIN MENU" button twice.

Tuning Procedure

Pos. Change

This feature will enable the user to swap (Exchange) channel memory of 2 selected channels. The position change function allows one to shift from the present channel to any programme number without any tuning process.

1.  Press the "PRE." PRESET button 7 times.

1	PRESET
AUTO TUNE	
MANUAL TUNE	
SOUND SYS	5.5MHz
COLOUR SYS	AUTO
FINE TUNE	
SKIP	OFF
POS. CHANGE	1

-  Press the "MAIN MENU" and "Position" buttons, until "POS. CHANGE" is selected.

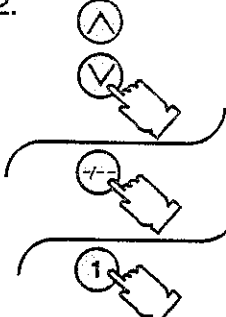
2.  Select a Programme number you want to change by pushing either Channel UP or DOWN button, two digit programme selection or Direct Programme number selection on the remote control. (Position change will only exist in preset mode).

1	PRESET
AUTO TUNE	
MANUAL TUNE	
SOUND SYS	5.5MHz
COLOUR SYS	AUTO
FINE TUNE	
SKIP	OFF
POS. CHANGE	1 2

Note:
Position change also can operated using panel key. Use PRESET key to enter POSITION CHANGE, then, use volume up/down to change the channel to be swapped to. Use TV/AV to confirm.

3.  Press the "TV/AV" button to confirm.



1 2	PRESET
AUTO TUNE	
MANUAL TUNE	
SOUND SYS	5.5MHz
COLOUR SYS	AUTO
FINE TUNE	
SKIP	OFF
POS. CHANGE	1 2

This returns the set to the normal viewing condition.

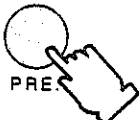
-  Press the "PRE." (PRESET) button once.

-  Press the "MAIN MENU" button twice.

Advanced Remote Control Transmitter Operation

Picture Menu Operation

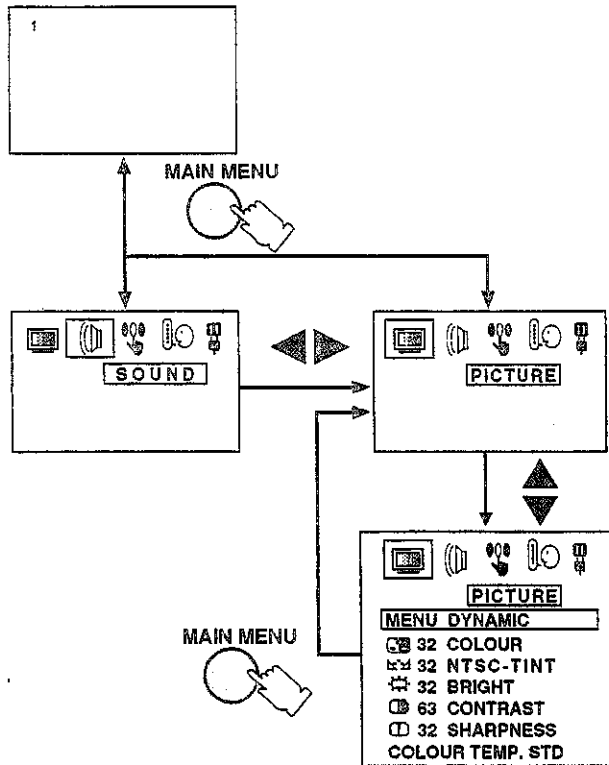

Picture Menu

Push	Item	Effect	Indicator
Select	MENU DYNAMIC	MENU DYNAMIC ↔ MENU STANDARD → MENU SOFT ←	MENU DYNAMIC
Select	COLOUR	Less More	32 COLOUR
Select	NTSC-TINT	Greenish Reddish	32 NTSC-TINT
Select	BRIGHT	Darker Brighter	32 BRIGHT
Select	CONTRAST	Less More	63 CONTRAST
Select	SHARPNESS	Less More	32 SHARPNESS
Select	COLOUR TEMP. STD	COLOURTEMP.STD ↔ COLOURTEMP.COOL → COLOURTEMP.WARM ←	COLOUR TEMP. STD

Helpful Hint

- By pushing the normal "N" button on the Remote Control while the Picture menu is displayed, the setting of the selected function will be return to factory setting level.

Advanced Remote Control Transmitter Operation

Sound Menu Operation

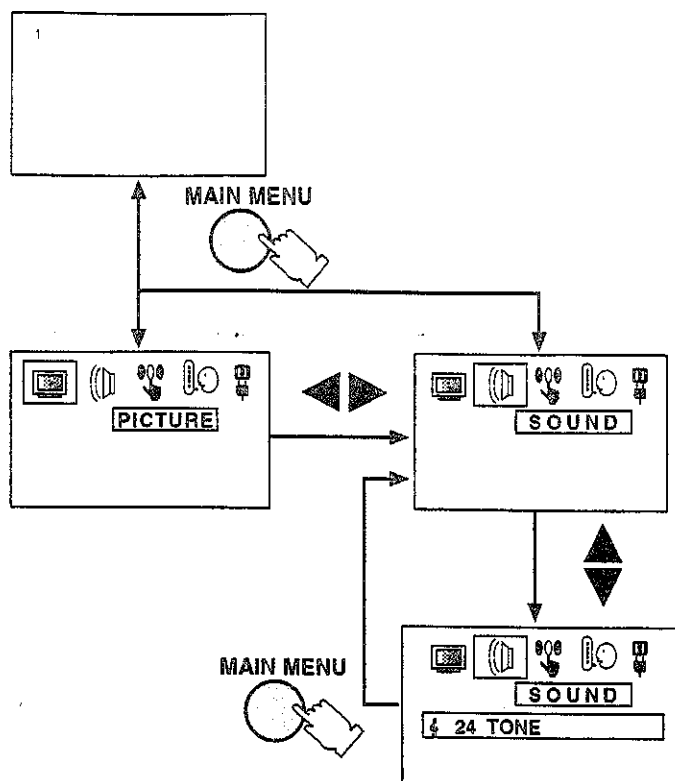

Sound Menu

Push	Item	Effect	Indicator
 Select	TONE	 Less More	24 TONE

Helpful Hint

1. By pushing the normal "N" button on the Remote Control while the Sound menu is displayed, the setting of Tone function will be return to factory setting level.

Advanced Remote Control Transmitter Operation

Features Menu Operation

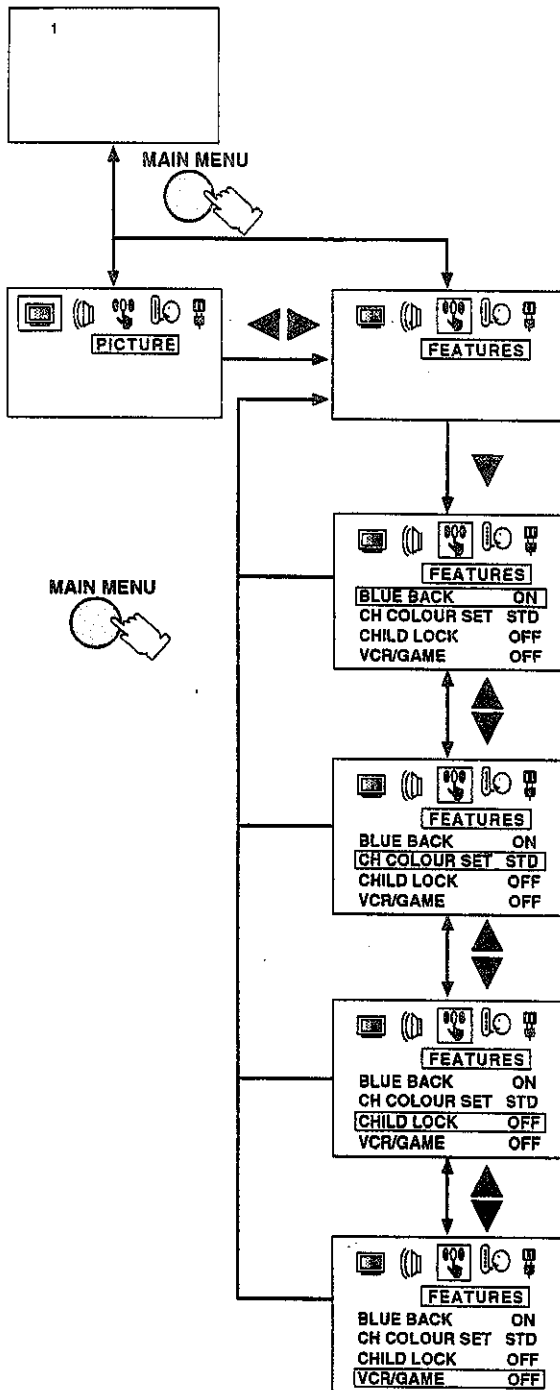

BLUE BACK Mode.

When no picture signal is received, or the signal is weak, the screen reverts to a blue background colour and the sound is muted. Disable this features to continue watching very weak signals.

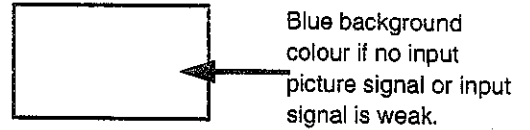

CH (Channel) COLOUR SET mode.

Colour density varying between broadcast channels can be adjusted to three levels for each reception channel as follows :



CHILD LOCK mode.

To child lock any channel, press the position left or right button.

- 1) When channel is "LOCK", sound is muted and screen becomes blue colour.
- 2) If any of the channels is CHILD LOCK, then preset key at any panel will not work. If preset key (Panel) is pressed, message "CHILD LOCK ON" will appear.
- 3) Main power ON in child locked channel will display "CHILD LOCK ON" on screen to remind user that the Child lock is On and is in Child locked channel.
- 4) Each channel has its own memory for channels to be child locked.

VCR/Game mode.

Reproduction of irregular signals, such as TV games and rental video tapes, may be improved. The VCR/GAME mode will change as shown.

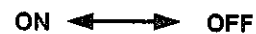

Advanced Remote Control Transmitter Operation

Language Menu Operation





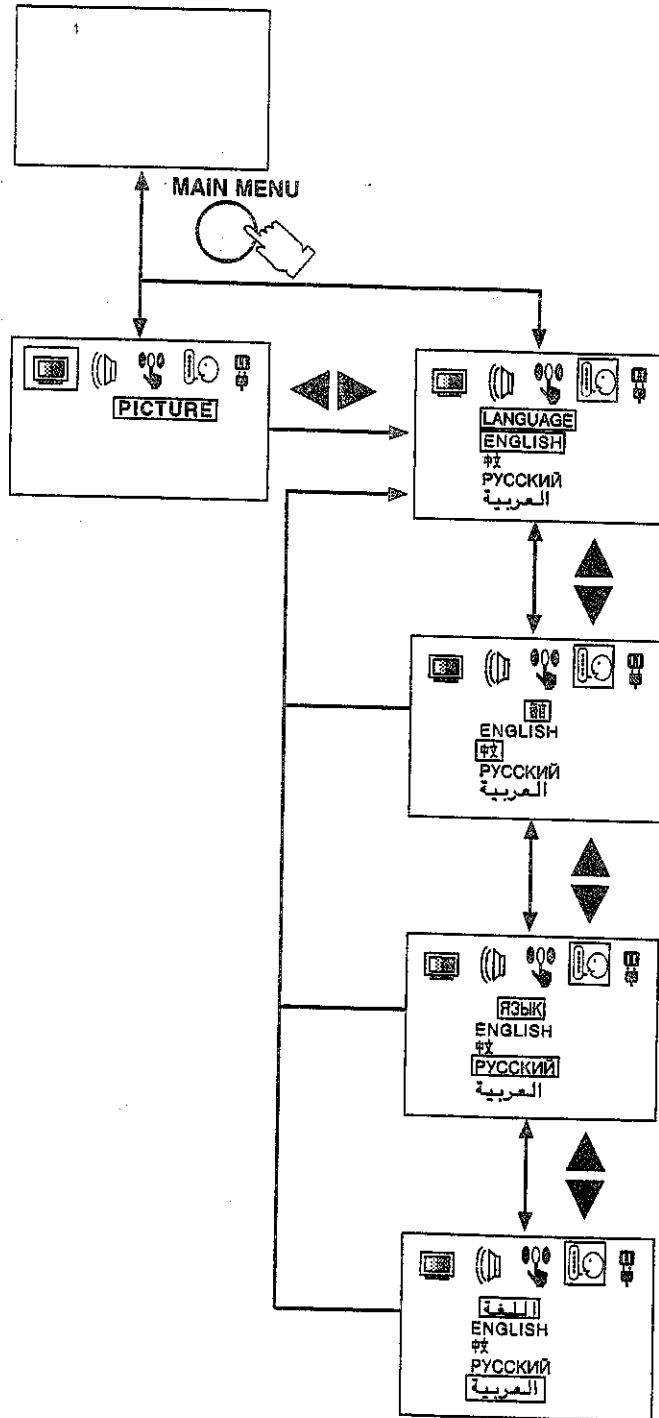













Language Menu

Press the "Position Up or Down" button. The on-screen language display will change as follows :



Troubleshooting

Before calling for service, determine the symptoms and make a few simple checks as shown below.

Symptoms		Checks
Picture	Sound	
 Snowy Picture	 Noisy Sound	Aerial Location, direction Connection
 Multiple Image	 Normal Sound	Aerial Location, direction Connection
 Interference	 Noisy Sound	Electrical Appliances Cars / Motorcycles Fluorescent Lamps
 Normal Picture	 No Sound	Volume (Check whether the mute function has been activated on the Remote Control.)
 No Picture	 No Sound	Not plugged into AC outlet Not switched on Contrast and Brightness / Volume Setting (Check by pushing the Power Switch or Stand-by Button on the Remote Control.)
 No Colour	 Normal Sound	Colour Control
 Scrambled	 Weak Sound	Re-tune Channels
 Colour Patches	 Normal Sound	Magnetic interference from unshielded equipment. Receiver moved while "ON"
 No Colour	 Noisy Sound	Sound System Colour System

Specifications

Power Source : AC AUTO 110-240V, 50/60Hz

Power Consumption : 74W

Receiving System : 17 SYSTEMS

	SYSTEMS	FUNCTION
1. 2. 3. 4. 5. 6. 7.	PAL B,G,H PAL I PAL D,K SECAM B,G SECAM D. K. SECAM K1 NTSC M (NTSC 3.58 / 4.5MHz)	Reception of broadcast transmissions and playback from video cassette tape recorders.
8. 9. 10. 11. 12. 13. 14.	NTSC 4.43 / 5.5MHz NTSC 4.43 / 6.0MHz NTSC 4.43 / 6.5MHz NTSC 3.58 / 5.5MHz NTSC 3.58 / 6.0MHz NTSC 3.58 / 6.5MHz SECAM I	Playback from special VCR only.
15. 16. 17.	PAL 60Hz / 5.5MHz PAL 60Hz / 6.0MHz PAL 60Hz / 6.5MHz	Playback from special Disc player and VCR only.

Receiving Channels :

VHF BAND		UHF BAND		CATV
2 - 12	PAL / SECAM B,K1	21 - 69	PAL G,H,I / SECAM G,K,K1	S1 - S20 (OSCAR)
0 - 12	PAL B (AUST.)	28 - 69	PAL B (AUST.)	1 - 125 (USA CATV)
1 - 9	PAL B (N.Z.)	13 - 57	PAL D,K	C13 - C49 (JAPAN)
1 - 12	PAL / SECAM D	13 - 62	NTSC M (JAPAN)	S21 - S41 (HYPER)
1 - 12	NTSC M (JAPAN)	14 - 69	NTSC M (U.S.A.)	Z1 - Z37 (CHINA)
2 - 13	NTSC M (U.S.A.)			5A, 9A (AUST.)

Tuning System : Frequency synthesizer Auto search tuning: 100 position.

Picture Tube : 51 cm, measured diagonally, 90° deflection.

Audio Output : 3.5 W

Aerial Impedance : 75 Ω Unbalanced coaxial.

Remote Control Transmitter : TNQ4G0401

Battery : R6 (AA) × 2

Dimension (W × D × H) : 508 × 475 × 470 mm

Weight (Net) : 23 kg

Note :

Design and Specifications are subject to change without notice.