

Panasonic

Operating Instructions

Colour Television

TC-25GF70R

TC-25GF72G

TC-25GF72H

TC-25AS1R

TX-25AS1X

TC-25V70R

TX-25V70T

This is a combined Operating
Instruction manual for above models.

Please read these instructions
before operating your set and
retain them for future reference.

Dear Panasonic Customer

Welcome to the Panasonic family of Customers. We hope that you will have many years of enjoyment from your new colour television set.

To obtain maximum benefit from your set, please read these Instructions before making any adjustments, and retain them for future reference.



Retain your purchase receipt also, and note down the Serial Number of your set in the space provided on the rear cover of these Instructions.

Table of Contents

Warnings and Cautions	4
Preparation	
How to Use This Manual	6
Quick Reference Guide for your TV Set	7
Before Operating This Set	
Connect the Aerial Cable to the RF In Terminal	8
Connect the Plug to the Wall Outlet	9
How to Turn the Power On	9
Battery Installation	9
Connection	10
Location of Controls	13
How to Select the LANGUAGE Function	15
Tuning Procedure	
Automatic Search	16
Manual Search	17
Fine Tuning	18
How to Cancel the Fine Tuning Function	19
Programme Number Skip	20
How to Cancel the Skip Function	21
General Operation	
How to switch the power ON or OFF	22
Programme Number Selection	22
Direct Programme Number Selection	22
Two Digit Programme Number Selection	23
Volume Adjustment	23
TV/AV Selection	23
Sound Mute	23
GAME	23
Recall	24
Off Timer	24
Function	25
Colour System Selection	26
Sound System Selection	27
Advanced Remote Control Operation	
Stereo Reception (For TC-25GF72G, TC-25GF72H, TX-25AS1X)	28
Surround Operation	30
Picture Menu Operation	31
Sound Menu Operation	32
Teletext Operation (For TX-25AS1X, TX-25V70T)	33
Operation of the VCR	36
Troubleshooting	37
Specifications	38

Warnings and Cautions

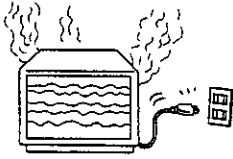
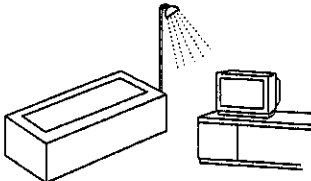
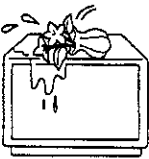
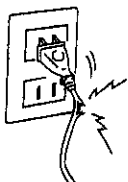
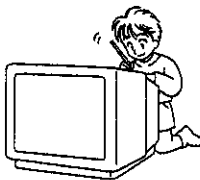
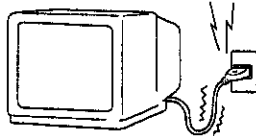
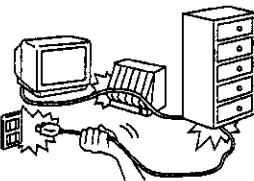
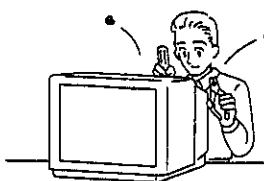
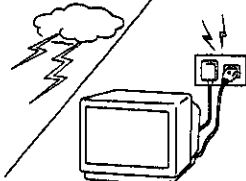
⚠ Warnings



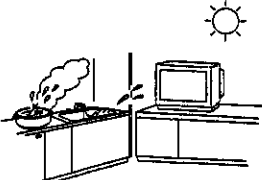
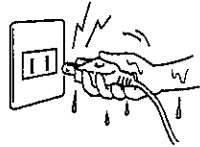

	<p>Unplug the power cord in the event of any malfunction (screen goes blank, no sound, odd sounds, smoke or unusual odors coming from the unit). Unplug the power cord if foreign matter or water falls into the unit, or if the unit is dropped or the cabinet is damaged.</p>		<p>DO NOT use this unit near water. (near a bath tub, etc.)</p>
	<p>DO NOT place any of the following on the unit: Flower vases, flower pots, cups, small metal objects, or cosmetics containers, chemicals or water.</p>		<p>DO NOT use if the power cord or power plug is damaged, or if the plug does not fit tightly into the socket.</p>
	<p>DO NOT insert foreign objects (metal or easily flammable objects).</p>		<p>DO NOT use at a voltage other than indicated.</p>
	<p>TAKE CARE NOT to damage the power cord.</p>		<p>DO NOT remove the rear cover as live parts and High Voltage components are accessible when the rear cover is removed.</p>
	<p>DO NOT touch the aerial cable and this unit when there is lightning.</p>		<p>DO NOT place in an unstable location.</p>

⚠ Cautions

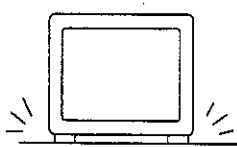
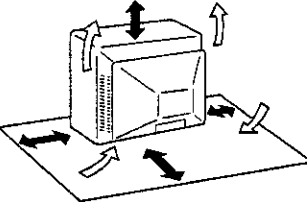
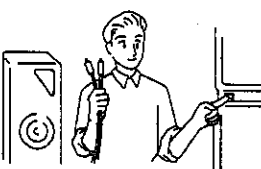
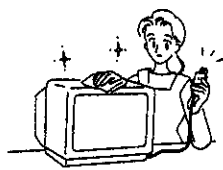

	<p>DO NOT place in humid or dusty locations, or areas exposed to smoke or steam. DO NOT place the direct sunlight and other sources of direct heat.</p>		<p>DO NOT touch the power plug if your hands are wet.</p>
---	---	--	---

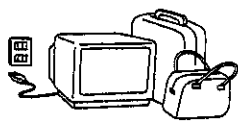
Warnings and Cautions

⚠ Cautions

	<p>DO NOT stand, or place heavy objects on the unit. Particular care should be taken by families with small children.</p>		<p>Place in a safe location.</p>
	<p>Adequate ventilation is essential to prevent failure of electrical components, we recommend that a gap of at least 10cm (↔) is left all around this unit even when it is placed inside a cabinet or between shelves.</p>		<p>Turn the power "Off" before connecting other electrical equipment.</p>
	<p>Before cleaning, unplug the power plug from the socket.</p>		<p>DO NOT jolt the unit.</p>
	<p>Unplug the power plug from the socket if you are not going to use the unit for an extended period.</p>		<p>Ask your sales outlet to install the aerial.</p>

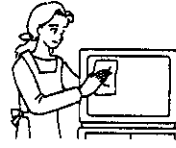
Cleaning

	<p>The unit contains many plastic parts. For this reason DO NOT use benzine, thinner or other chemicals to clean the unit.</p>		<p>Dust will accumulate on the picture screen. Please wipe with a soft cloth from time to time. If you use a chemically treated cloth, please be careful to follow the instructions that come with the cloth.</p>
	<p>DO NOT bring into contact with insecticide or other volatile substances. DO NOT allow the unit to come into contact for extended periods with rubber or vinyl products.</p>		<p>Remove dirt and soiling by wiping with a light cloth. Even if the unit is heavily soiled, do not apply cleaner directly to the unit. Soak a cloth in a solution of neutral cleanser thinned with water. Then wring out the cloth, wipe the unit clean, and finish by wiping with a dry cloth.</p>

Preparation

How to Use This Manual

1. Check the Model Number of your TV set; the Model Number is shown on the rear cover name plate on the set. Use the table on the opposite page to confirm which features your particular Model is equipped with. This will help you to know which sections of the manual apply to your set.
2. Check the Part Number on the rear of your Remote Control handpiece, and note the functions available, as shown below.

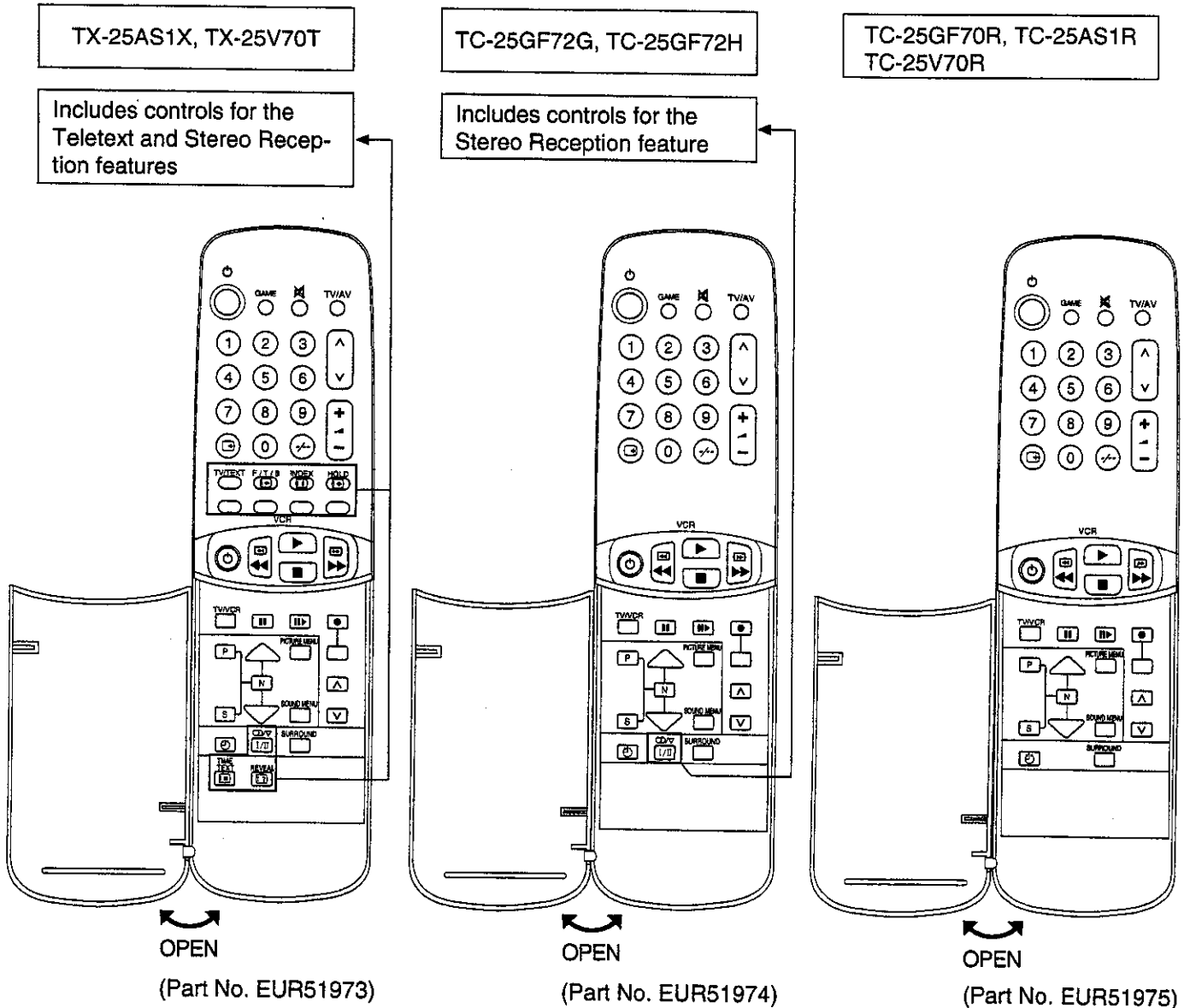

Preparation

Quick Reference Guide for your TV Set

Please check the model number of your TV set.

This Manual applies to several Models and there are slight differences among them.

Please check the table below to see what your TV is equipped with before you begin using these Operating Instructions. Instructions are given for all functions, please disregard these which do not apply to your TV.

		Model No.	TC-25GF72G	TC-25GF72H	TC-25GF70R	TC-25AS1R	TX-25AS1X	TC-25V70R	TX-25V70T	Refer to page(s)	
FEATURE	Stereo	NICAM I	*	*						P28, 29	
		NICAM B,G	*	*			*				
		GERMAN					*				
		MONO			*	*		*	*		
	Multi Language	English	*	*	*	*	*	*	*	P15	
		Chinese	*	*	*	*	*				
		Russian						*	*		
	TEXT					*		*	P33		
	SPECIFICATIONS	Power Source	AC Auto 110V/220V 50/60Hz	*	*						P38
			AC 220V 50Hz			*					
AC Auto 110V/240V 50/60Hz						*	*				
AC 220V 50/60Hz								*	*		
CATV		HYPER	*	*	*	*	*	*	*	P38	
Position Memory (100 position)		*	*	*	*	*	*	*	P39		
External Surround Terminals			*						P12		

*: Function available

Before Operating This Set

Connect the Aerial Cable to the RF In Terminal

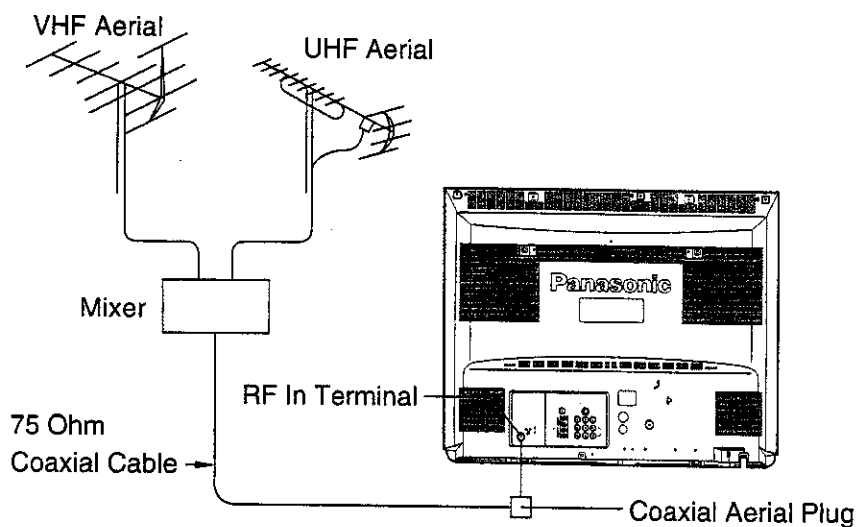

To obtain optimum quality picture and sound, an Aerial, the correct cable (75 Ohm coaxial) and the correct terminating plug are required.

If a communal Aerial system is used, you may require the correct connection cable and plug between the wall Aerial socket and your television receiver.

Your local Television Service Centre or Dealer may be able to assist you in obtaining the correct Aerial system for your particular area and accessories required.

Any matters regarding Aerial installation, upgrading of existing systems or accessories required, and the costs incurred, are the responsibility of you, the Customer.

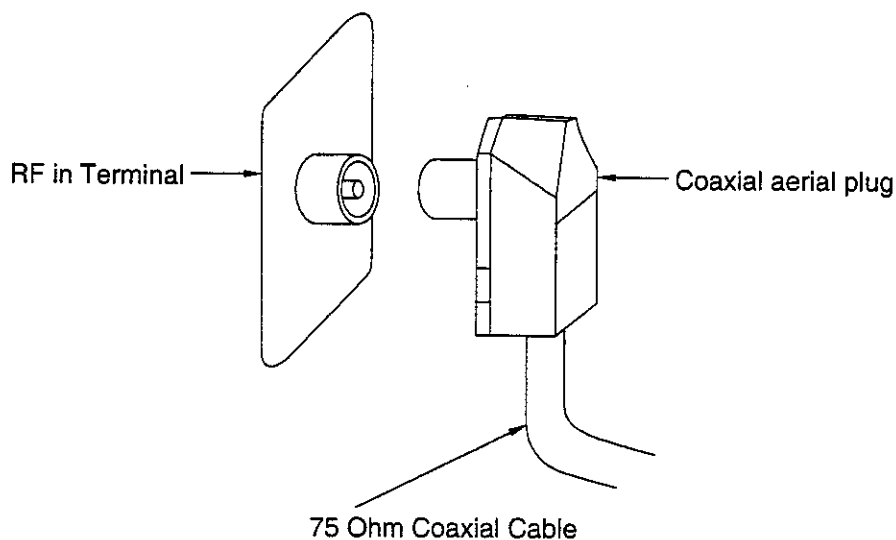

Before Operating This Set

Connect the Plug to the Wall Outlet

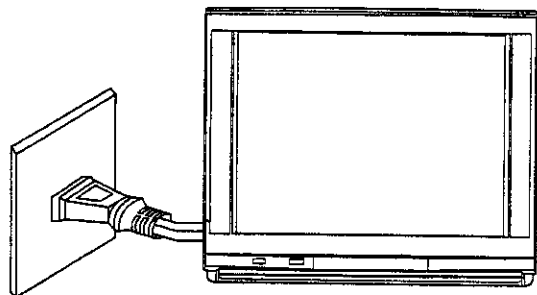

Note:

Mains plug types vary between countries. The mains plug shown at left may therefore not be the type fitted to your set.

How to Turn the Power On

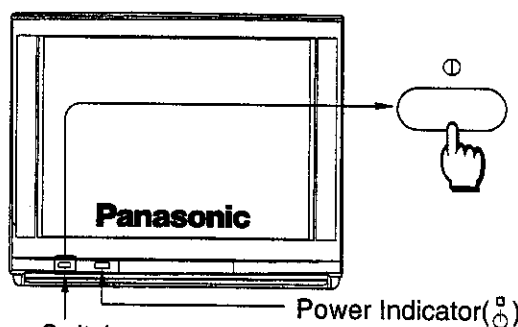

Main Power Switch

Power Indicator (P)

Push the Main Power switch on the Television to turn the set on.

The Power Indicator will light. (Red)

Note:

- (1) When in the Stand-by condition (Refer to page 22), it is possible to turn the TV set on by pushing the "Power (Stand-by)" Button or the Programme Number Up and Down Buttons on the TV set or Remote Control.
- (2) In order to discriminate this set from imitations, PANASONIC will appear on the screen for about 10 seconds. (For TC-25GF70R, TC-25GF72G)

Battery Installation

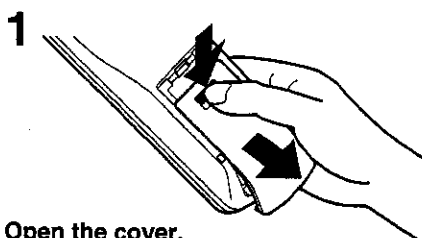

1
Open the cover.

Apply slight downward pressure while pulling towards the bottom.

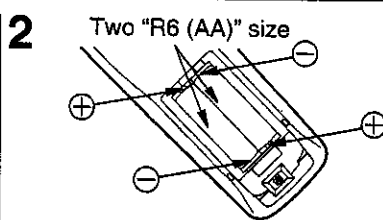

2
Two "R6 (AA)" size
Batteries: Use two "R6 (AA)" size batteries.

Insert the batteries ensuring correct polarity. This is identifiable by the "+" and "-" symbols on both the batteries and inside the battery compartment.

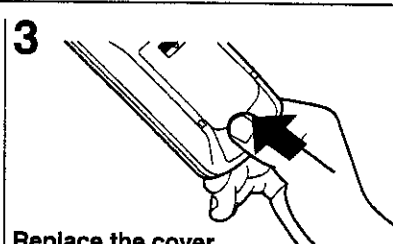

3
Replace the cover.

Do not use rechargeable (Ni-Cd) batteries.

They are different in shape and performance and may fail to ensure correct operation.

Battery precautions

The incorrect use of batteries can cause electrolyte leakage which will corrode the Remote Control or cause the batteries to burst.

Old Batteries

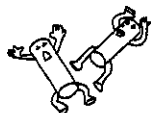

Replace both batteries at the same time.

New Batteries



Don't mix battery types
(alkaline with carbon zinc, etc.)



Don't Recharge.

Connections

How to connect the "AV1 or 2" Input Terminals.

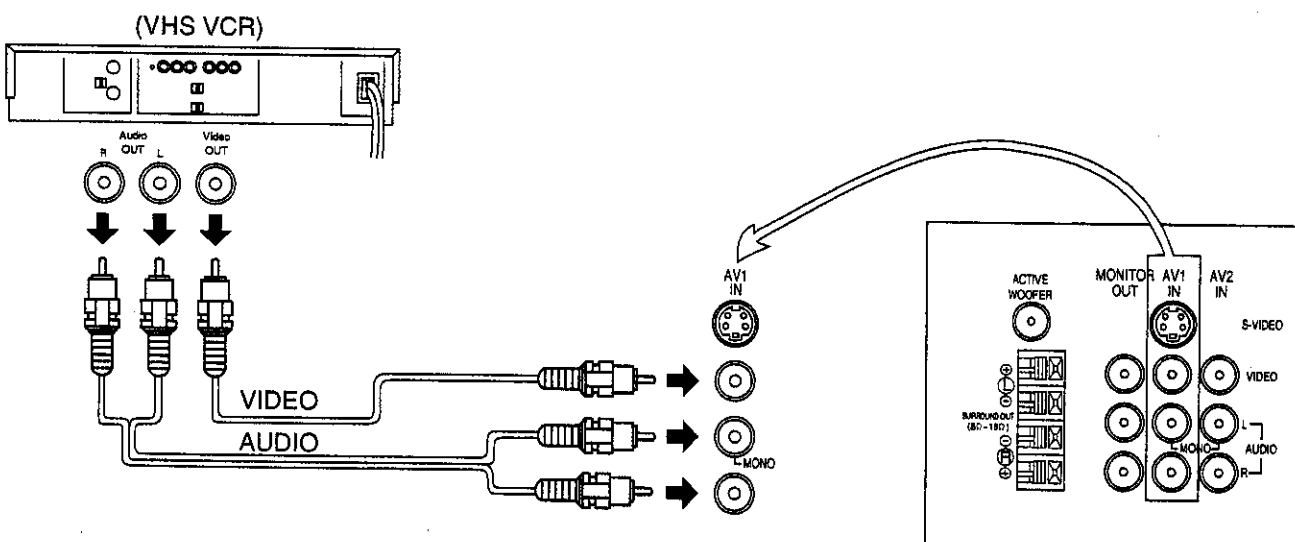
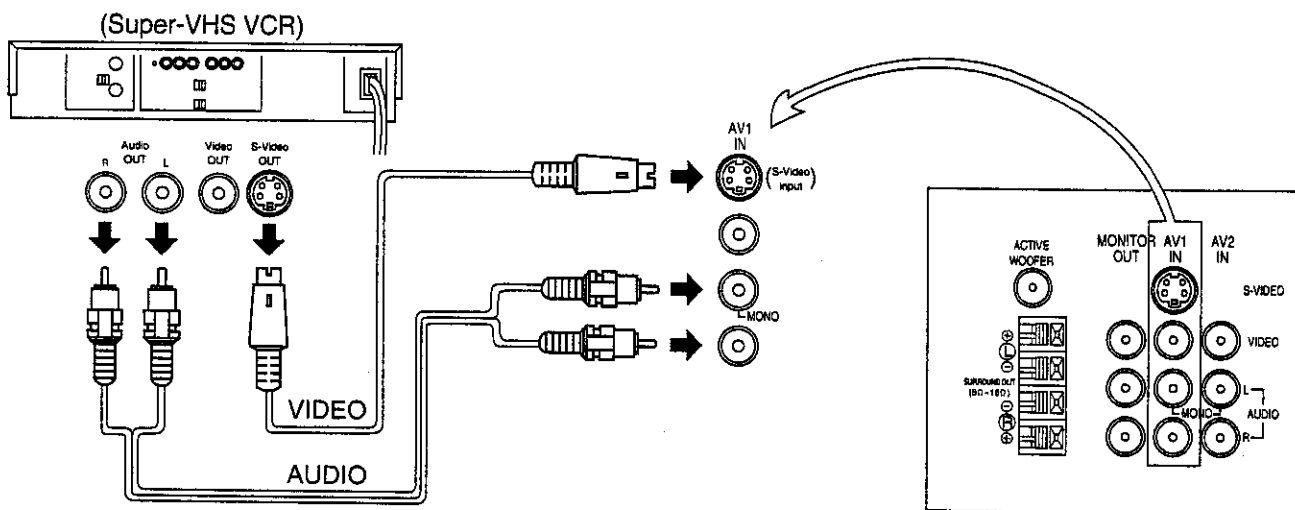

Note:

- (1) When AV1 or AV2 is selected, and that AV mode has no input picture signal, the Background Colour of the screen will change. (This only occurs if the Recall function is set to the OFF condition; refer to page 24 for details.)
 - (2) When an S-Video cable is connected to the S-Video terminal, the Phono Video input will be automatically switched off for that AV mode.
 - (3) When a Monaural VCR is used, connect the Monaural Audio cable to the Audio "LEFT" terminal.
 - (4) Similar connections are available at the AV1 and AV2 input terminals.
- Select the desired AV input position by pushing the TV/AV Mode selection button. (Refer to page 23)

Connections

How to connect the AV MONITOR OUTPUT terminals to other equipment.

The MONITOR OUT terminals output the same signals as are on the TV screen at that time, e.g. TV programmes or signals from AV1 or AV2 input.

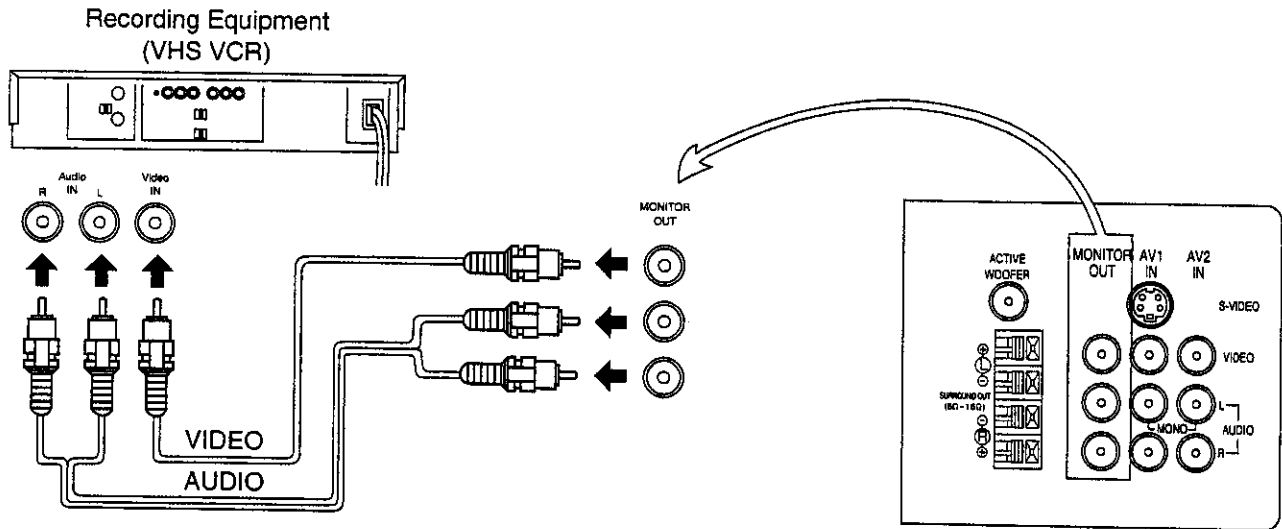

Note:

- (1) Never connect the same video recorder with both the VIDEO IN and MONITOR OUT terminals on this TV set, as this could cause incorrect operation.
- (2) Teletext displays on screen will not be output at the MONITOR OUT terminals.

Connecting the GAME

Connect the GAME as follows.

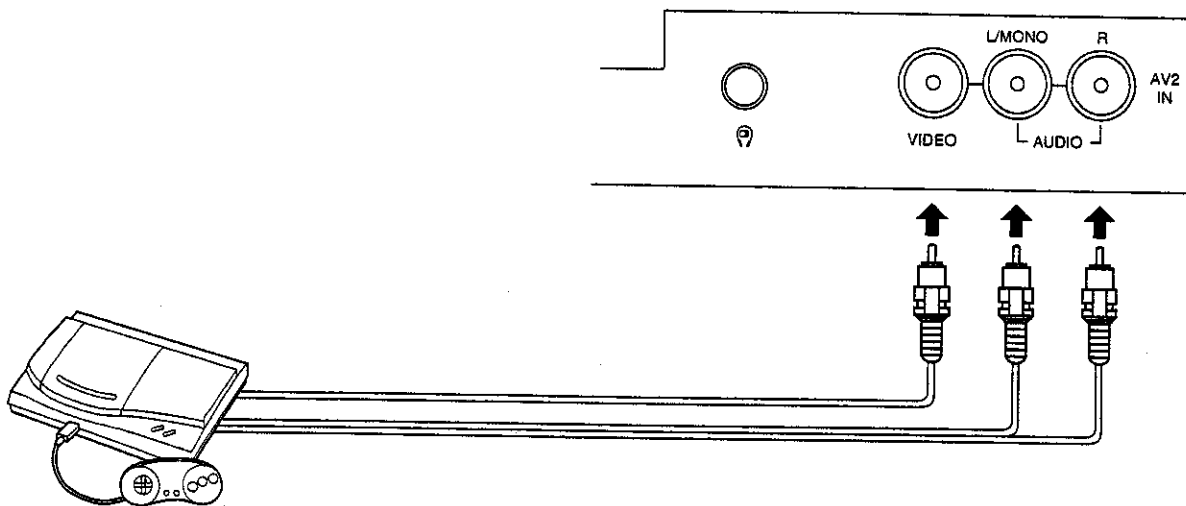

Note:

The front AV2 Input terminals have priority. When connected to both the front and back AV2 Input terminals, the front AV2 Input terminals signal will be selected as input. Use the front AV2 Input terminals when using the unit for games.

Connections

Connecting Headphones

Connect headphones as follows.

When a Headphones plug is inserted into the Headphones socket all speakers will be automatically disconnected; only the Headphones will function.

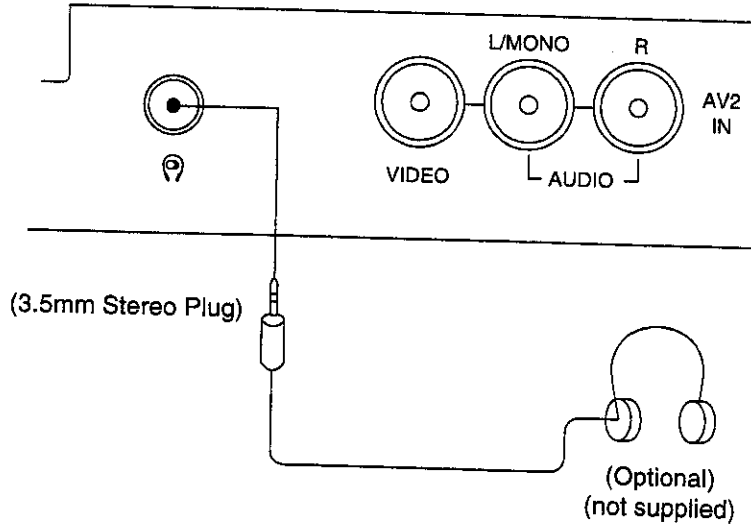

Connecting Surround Speakers (Only for TC-25GF72H)

Connect the surround speakers as follows.

The Surround effect is enhanced by connecting external surround speakers. (optional)
Although it is possible to enjoy the "Surround effect" with this TV set as it is, upon connecting separate "Surround Speakers" the presence of the enveloping sound becomes more vivid.

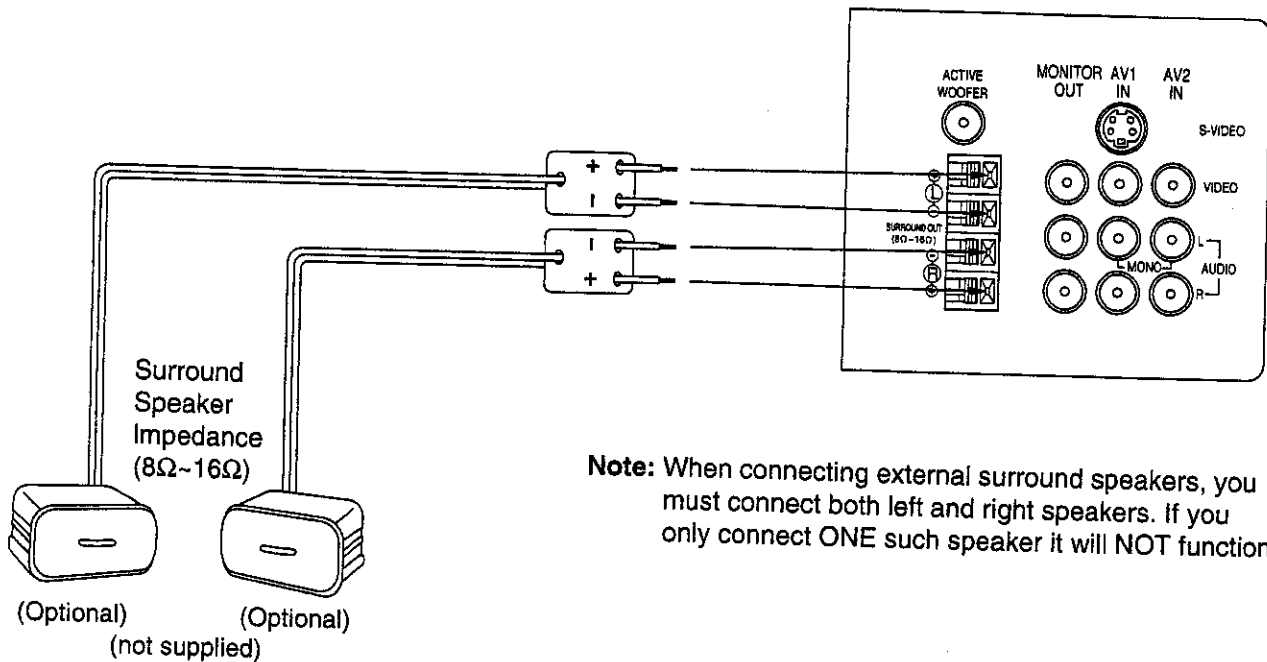

Location of Controls

Refer to the pages indicated in ● for details.

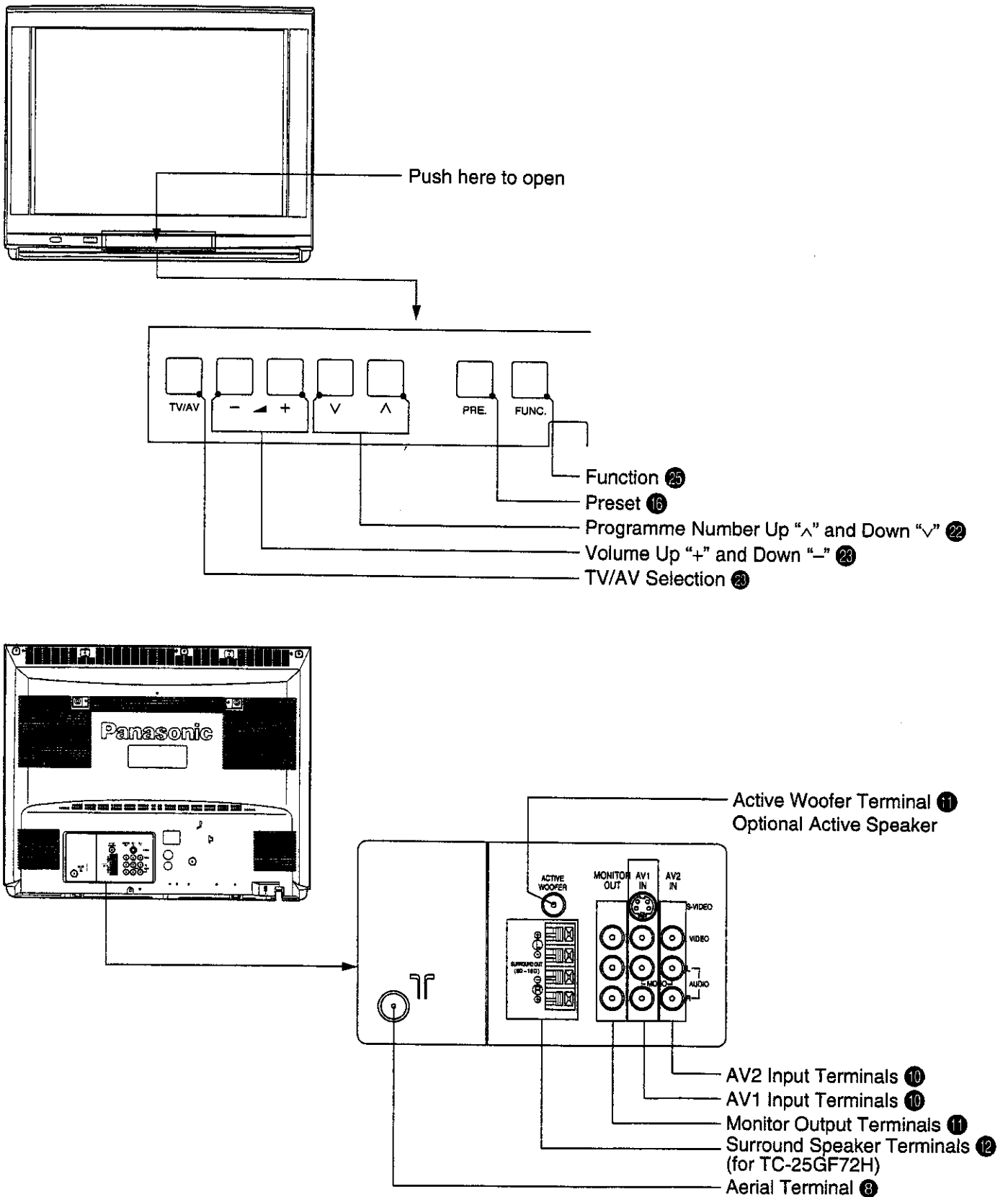

Location of Controls

Refer to the pages indicated in ● for details.

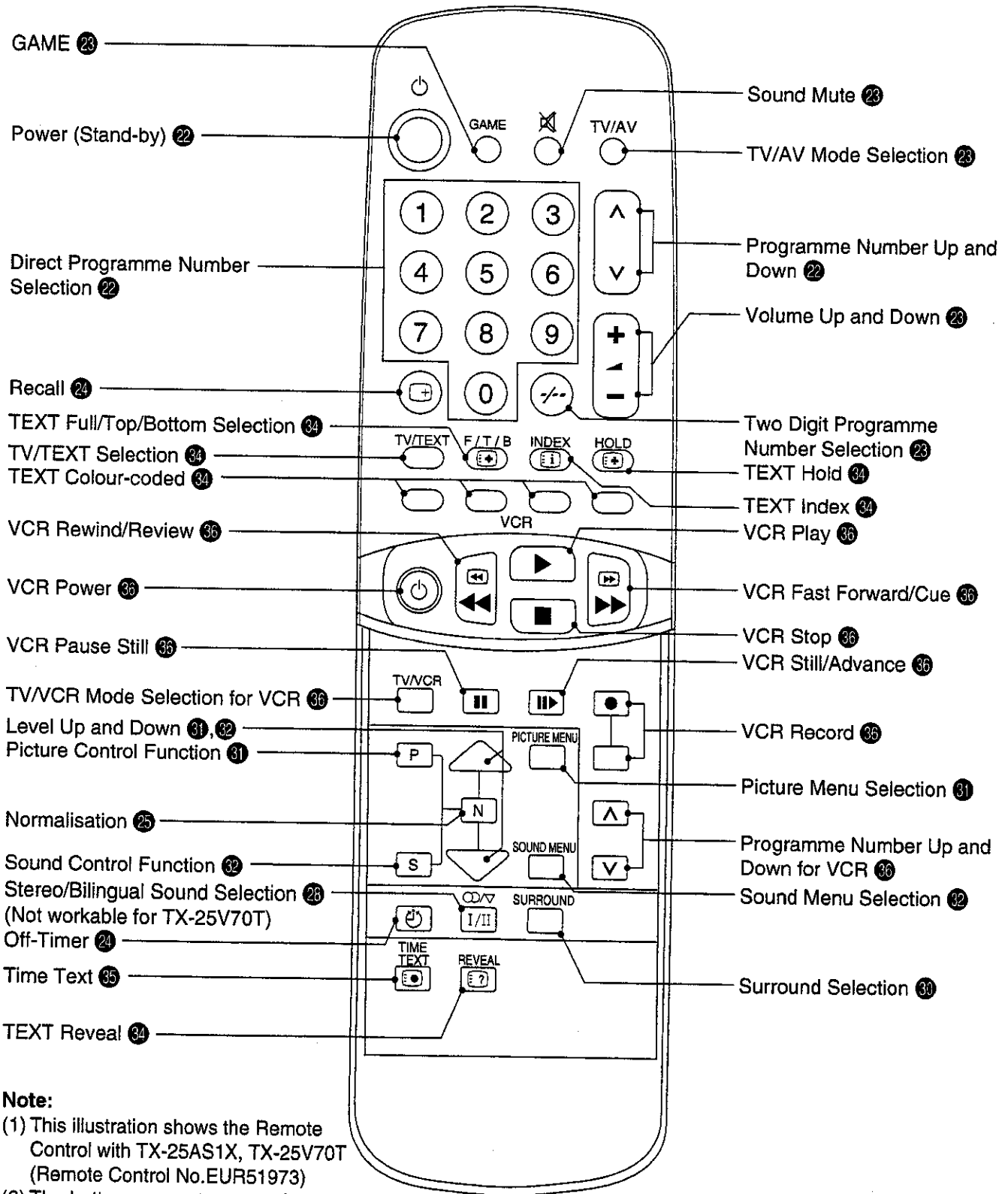

Note:

- (1) This illustration shows the Remote Control with TX-25AS1X, TX-25V70T (Remote Control No.EUR51973)
- (2) The buttons are not present for Models not equipped with certain features. The diagram on page 6 and the table on page 7 identify such variations.

How to Select the LANGUAGE Function

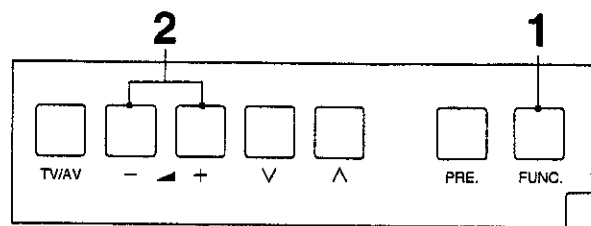

Languages display on-screen can be selected by following method.

1



By pushing the "FUNC. (Function)" Button, you can select the LANGUAGE Selection Mode.

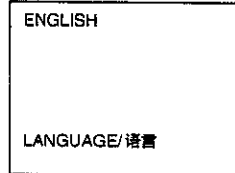

2

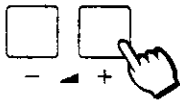

Push the Volume Up "+" Button. The on-screen language display will change.

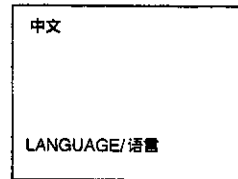

3

This returns the set to the normal viewing condition after 10 seconds.

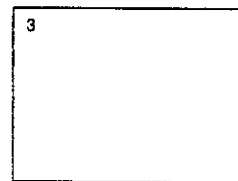

Tuning Procedure

Automatic Search

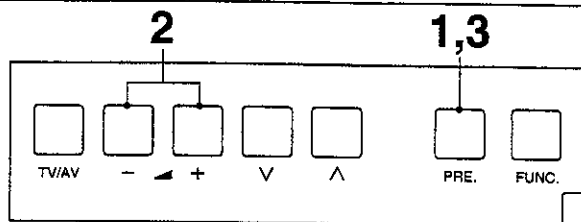

This TV set will search automatically through all of the VHF and UHF bands. After completion, the best tuning position is automatically memorized on each Programme Number sequentially.

1



Push the "PRE." (PRESET) Button, setting the Automatic Search Mode.

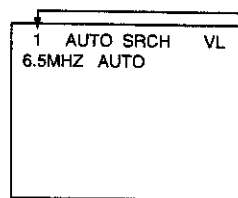

Programme Number
Automatic Search
Condition

2

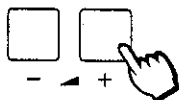

Push the Volume Up "+" Button.

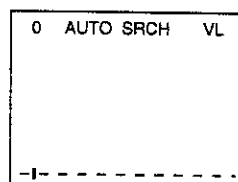

Search Start

The best tuning position is automatically memorized.

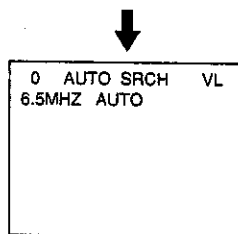

3



Push the "PRE." (PRESET) Button 3 times.

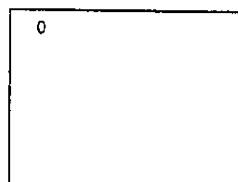

This returns the set to the normal viewing condition.

Helpful Hint

- (1) If a clear picture cannot be obtained even when a Broadcast is received, refer to the "Colour System Selection" operation on page 26.
- (2) When the sound is not clear or no sound is produced on a Programme Number, refer to the "Sound System Selection" operation on page 27.
- (3) Repeated pushing of the "PRE. (PRESET)" button changes the Preset Menu as follows.

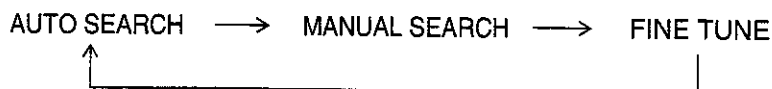

Tuning Procedure

Manual Search

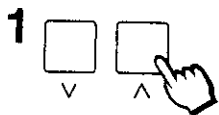
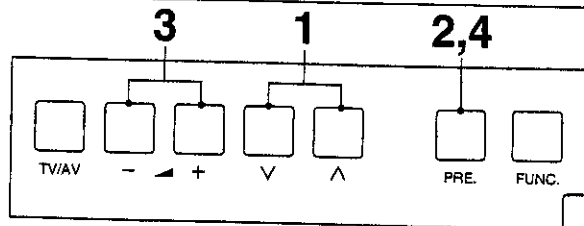

Push either the Programme Number Up " \wedge " or Down " \vee " Button.

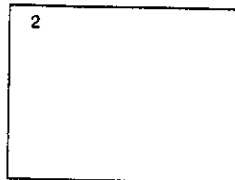

Select the desired Programme Number.

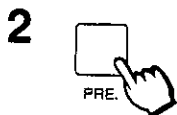

Push the "PRE." (PRESET) Button twice, setting the Manual Search Mode.

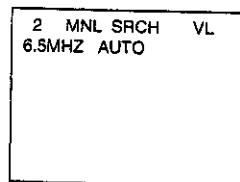

Manual Search Condition

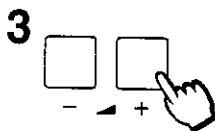

Push the Volume Up "+" or Down "-" Button.
Volume "+" : Next higher Channel
Volume "-" : Next lower Channel

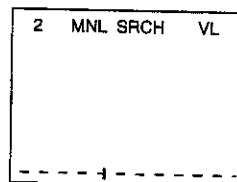

Search Start

The best tuning position is automatically memorized.

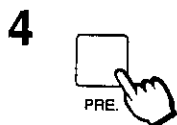
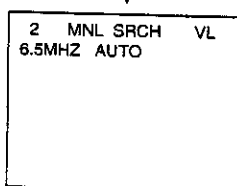

Push the "PRE." (PRESET) Button twice.

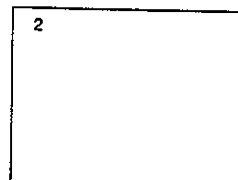

This returns the set to the normal viewing condition.

Helpful Hint

- (1) If a clear picture cannot be obtained even when a Broadcast is received, refer to the "Colour System Selection" operation on page 26.
- (2) When the sound is not clear or no sound is produced on a Programme Number, refer to the "Sound System Selection" operation on page 27.
- (3) In case of NTSC M System, select the Sound System to 4.5MHz. (Refer to page 27)

Tuning Procedure

Fine Tuning

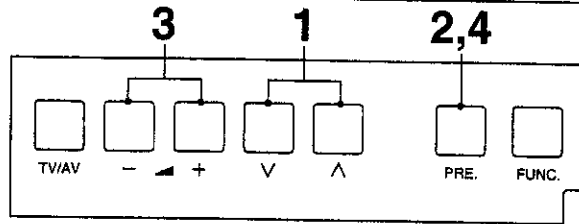

Under normal reception conditions this function is not required or necessary. However, in areas of poor reception or constant interference, a slight adjustment of the tuning may improve the picture and sound quality.

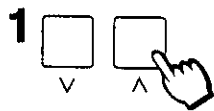

Select the channel which you want to try to improve, using the Programme Number Up “^” or Down “v” Buttons.

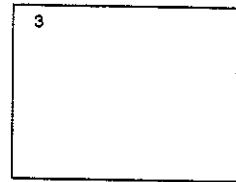

Select the desired Programme Number.

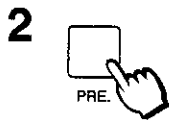

Push the “PRE.” (PRESET) Button 3 times, setting the Fine Tuning Mode.

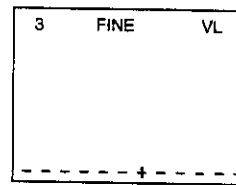

Fine Tuning Condition

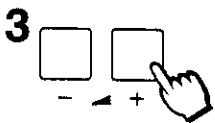

Push the Volume Up “+” or Down “-” Button until the clear picture is received.

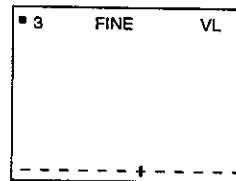

The AFC (Automatic Frequency Control) function is deactivated. The “■” symbol appears to the left of the Programme Number.

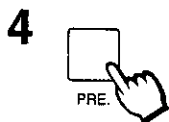

Push the “PRE.” (PRESET) Button.

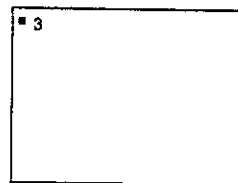

This returns the set to the normal viewing condition.

Tuning Procedure

How to Cancel the Fine Tuning Function

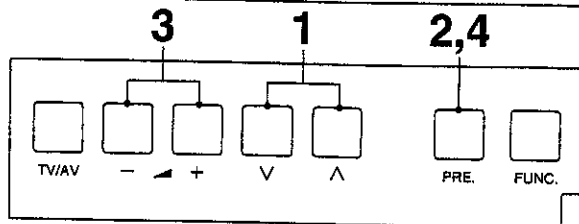

Canceling previously adjusted (manually) fine tuning, means re-activating the AFC (Automatic Frequency Control) Function, also known as AFT (Automatic Fine Tuning). Re-activating the Automatic Fine Tuning means albaming the set to automatically tune to the optimum tuning position, for that Programme Number.

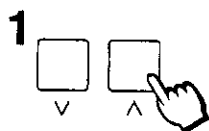

Select the "AFC OFF" Programme Number which you want to return to Automatic Frequency Control (cancel the manual fine tuning).

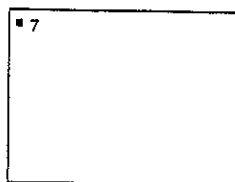

"AFC OFF" Programme Numbers are indicated to you by the "■" symbol to the left of the Programme Number.

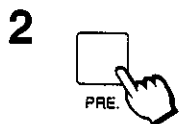

Push the "PRE." (PRESET) Button twice, setting the Manual Search Mode.

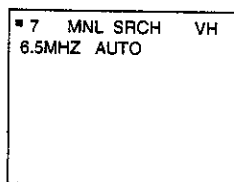

Manual Search Condition

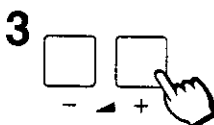

Push the Volume Up "+" or Down "-" Button, briefly.

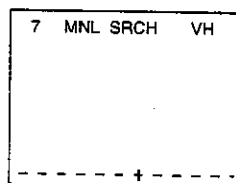

The best tuning position is automatically memorized.

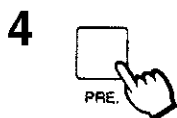

Push the "PRE." (PRESET) Button twice.

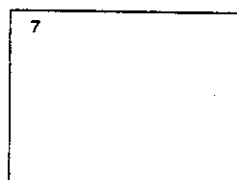

This returns the set to the normal viewing condition.

Tuning Procedure

Programme Number Skip

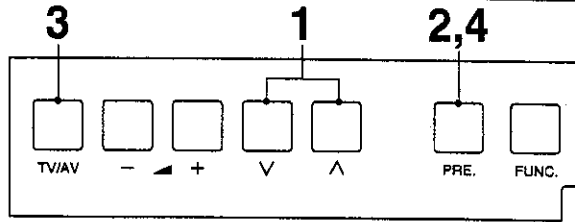

It is possible to Skip Programme Numbers on which no TV stations are tuned appearing on the screen.

The function is only effective when selecting Programme Numbers by pushing the Programme Number Up or Down Buttons either on the TV set or the Remote control.

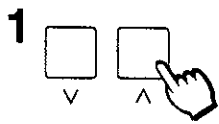

Select a Programme Number you want to skip, by pushing the Programme Number Up "▲" or Down "▼" Buttons.

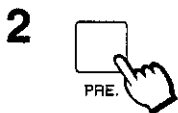
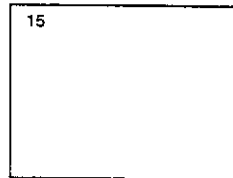

Push the "PRE." (PRESET) Button, setting the Automatic Search Mode.

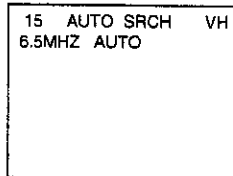

Automatic Search Condition

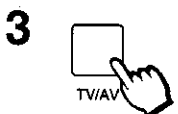

Push the "TV/AV Selection" Button.

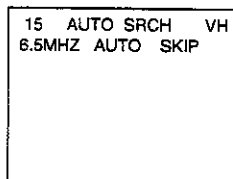

The SKIP function is now set.

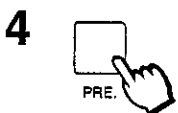

Push the "PRE." (PRESET) Button 3 times.

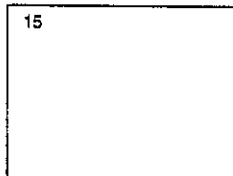

This returns the set to the normal viewing condition.

Tuning Procedure

How to Cancel the Skip Function

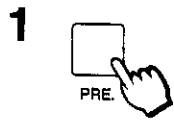
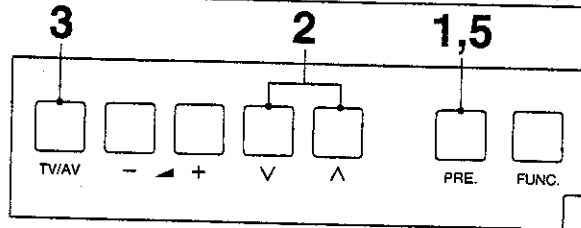

Push the "PRE." (PRESET) Button, setting the Automatic Search Mode.

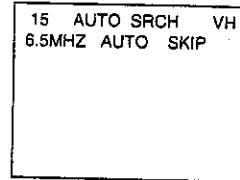

Automatic Search Condition

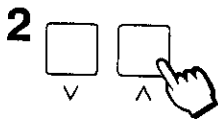

Select the skipped Programme Number, by pushing the Programme Number Up " \wedge " or Down " \vee " Buttons.

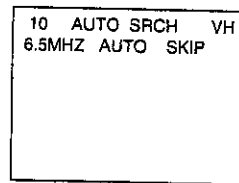

The "SKIP" indicator will appear on the screen.

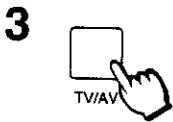

Push the "TV/AV Selection" Button.

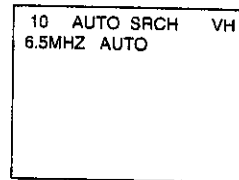

The SKIP function is now cancelled.

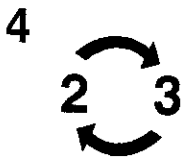

Repeat Steps 2 and 3, if you wish to cancel the Skip function on any other Programme Number.

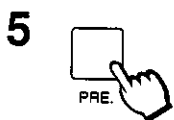

Push the "PRE." (PRESET) Button 3 times.

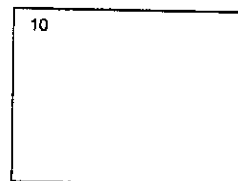

This returns the set to the normal viewing condition.

General Operation

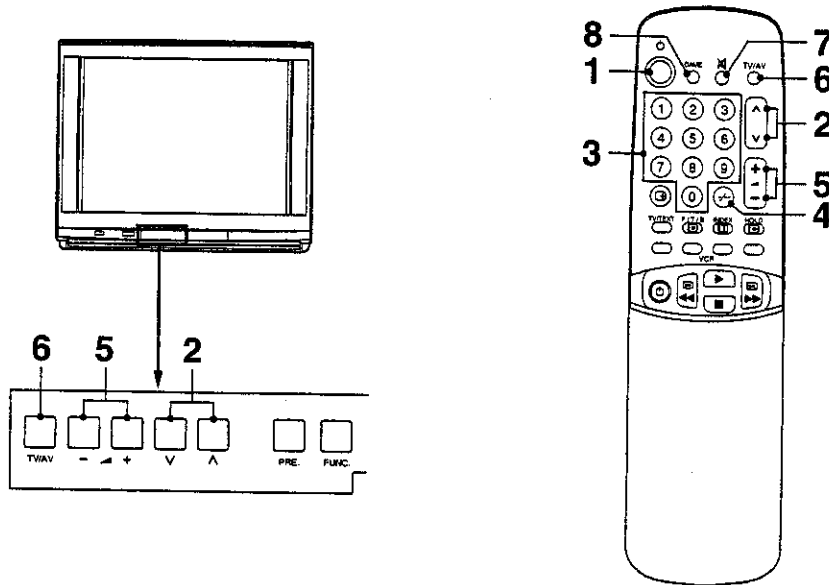

1



How to switch the power ON or OFF

The TV set must first be switched on at the wall outlet and at the Main Power Switch. (Refer to page 9).

Push this button to turn the TV set ON, from STAND-BY mode.

Push it again to turn the TV set OFF (to STAND-BY).

It is also possible to turn the TV set ON from STAND-BY by pushing the "Direct Programme Number Selection" Buttons (0-9) and "Programme Number Up or Down" Button.

2

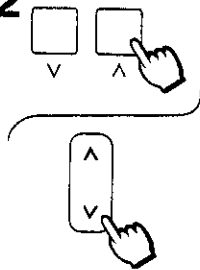

Programme Number Selection

Push the Programme Number Up "∧" or Down "∨" Button to select the next higher or lower Programme number.

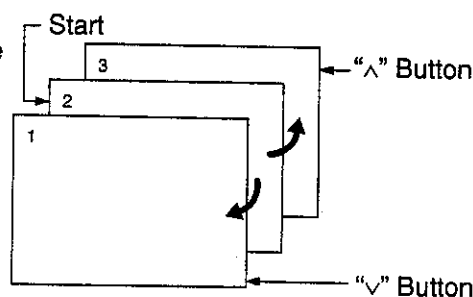

3



Direct Programme Number Selection (Programme Numbers 0-9)

e.g. To select Programme Number "1", push the ① Button.



You can select the numbers 0 to 9 directly by pushing the corresponding number button on the Remote Control.

General Operation

4



Two Digit Programme Number Selection

e.g. To select Programme Number "24".

Push the Button

Push the Button

Push the Button

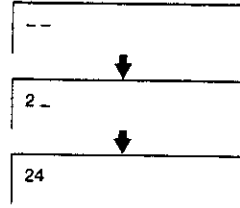

You can select a two Digit Programme Number.

Setting range	0~99
---------------	------

5

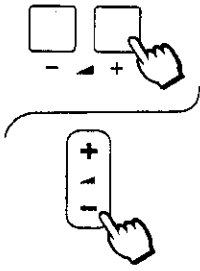

Volume Adjustment

Push the Volume Up "▲" or Down "▼" Button to increase or decrease the sound volume level.

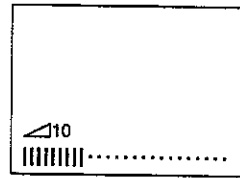

Note:

The on-screen display will indicate both numerically and graphically the volume level. Numeric levels start at "0" for zero or no sound, and will increase up to 63 which is the maximum sound level.

6

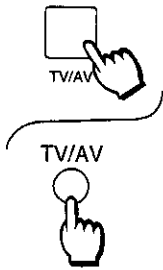

TV/AV Selection

Push the "TV/AV" Button to select TV, AV1, AV2 input signal modes sequentially.

Note:

If a clear picture cannot be obtained even when a AV signal is received, refer to the "Colour System Selection" operation on page 26.

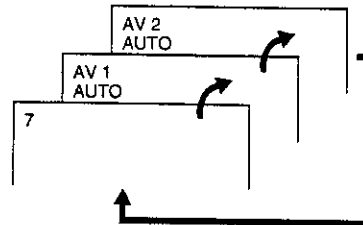

7



Sound Mute Button

Push this button to mute the Sound completely.

Push the button once again to restore the previous sound level, and cancel the mute.



The "Mute" symbol will appear. (colour change to Red)



8



GAME Button

This button provides a convenient switching feature. Push this button to enter game mode (Game mode is actually AV2 mode).

Push again to cancel.

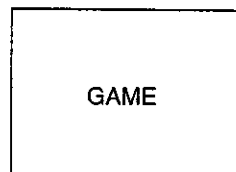

The "GAME" Indicator will appear.

General Operation

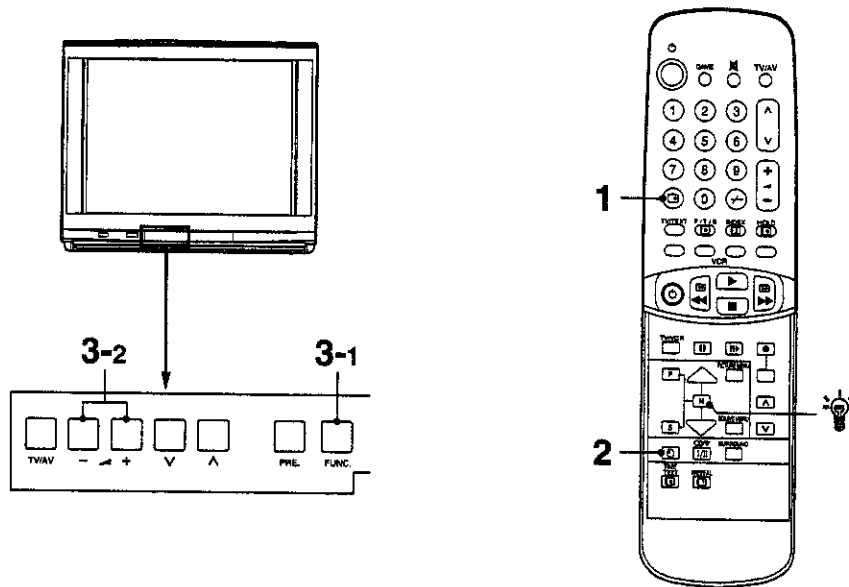

1



Recall Button

Push the "Recall" Button to display the current system status.

Push this button until the cancel.

Note:

In the AV mode, a blue colour screen appears, if there is no AV signal, when the recall function is off.

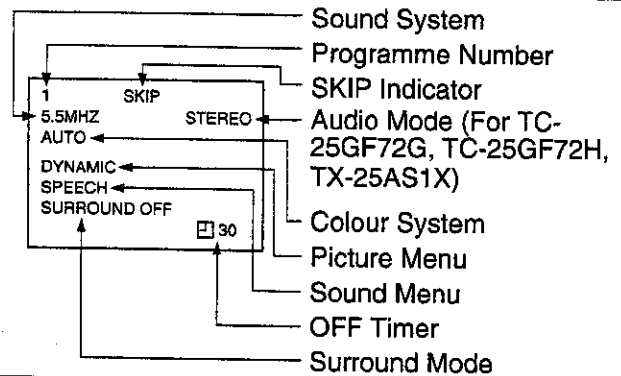

2



Off Timer Button

The TV set may be preset to switch to stand-by after a fixed period. By pushing "Off-Timer" Button, you can select the preset time either "30", "60" or "90" minutes.

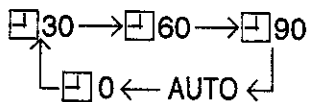

To confirm the remaining time, push the "Recall" Button.

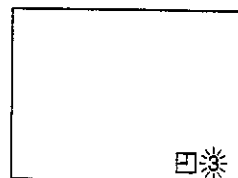
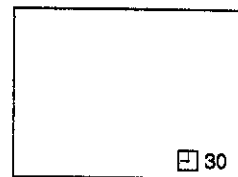

When the Off-Timer reaches its last 3 minutes, it starts blinking before going to stand-by condition.

Note:

Setting Off-Timer to AUTO mode.

If the set is not switched Off, when the TV station ends broadcasting, it will automatically go to stand-by condition after 5 minutes. This AUTO mode will not operate when the TV receiver is in AV mode.

How to cancel the off-timer setting

1. Set the pre-set time condition to "0" mode by pushing the "off-timer" button.
2. Turning the TV set off, using the button on the remote control or the power switch button on the TV set.

General Operation

3-1



Function Button

By pushing this button repeatedly, the Picture Control Function, Sound Control Function, Colour System, Sound System and Language Function will be displayed as follows.

3-2

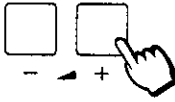

Push the Volume Up "+" or Down "-" Buttons to adjust the level and Select the Menu.

Function	FUNC		(Indicator)
	TV mode	AV mode	
COLOUR	→*	→*	32 COLOUR
NTSC-TINT*	*↓	*↓	32 NTSC-TINT
BRIGHT	*↓	*↓	32 BRIGHT
CONTRAST	*↓	*↓	48 CONTRAST
SHARPNESS	*↓	*↓	32 SHARPNESS
BASS	*↓	*↓	32 BASS
TREBLE	*↓	*↓	32 TREBLE
BALANCE	*↓	*↓	32 BALANCE
COLOUR-SYS	*↓	*↓	(TC-25GF72G, TC-25AS1R) (TC-25GF72H, TX-25AS1X) (TC-25V70R, TX-25V70T)
			(TC-25GF70R)
SOUND-SYS	*↓	*↓	(TC-25GF72G, TC-25AS1R) (TC-25GF72H, TX-25AS1X) (TC-25GF70R)
			(TC-25V70R, TX-25V70T)
LANGUAGE	*↓	*↓	(TC-25GF72G, TC-25AS1R) (TC-25GF72H, TX-25AS1X) (TC-25GF70R)
			(TC-25V70R, TX-25V70T)

***Note:**

The picture can only be adjusted when the NTSC-TINT is receiving an NTSC signal.

Helpful Hint (N Normalisation)



By pushing the Normal "N" Button on the Remote Control while the Picture or Sound Control Function is displayed, the Selected function will be changed to the Normal Mode.

Normalisation will not occur if the function is not displayed when the "N" Button is pushed.

The Normal mode is the factory preset condition. Returning to this original condition is called "Normalisation".

General Operation

Colour System Selection

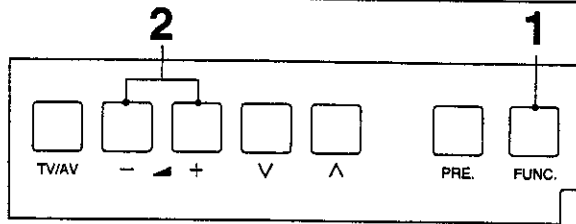

If a clear picture with weak colours is obtained when a Broadcast or AV Signal is received.

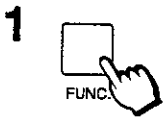

By pushing the "FUNC. (FUNCTION)" Button, you can select the Colour System Selection Mode.

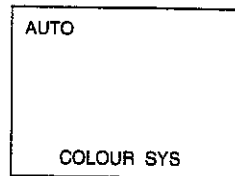

Colour System Selection mode

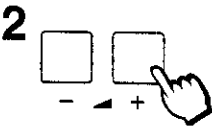

Push the Volume Up "+" Button repeatedly until the optimum image is produced.

You may improve the colour system condition.

TC-25GF72G TC-25GF72H TC-25AS1R TX-25AS1X	TC-25GF70R	TC-25V70R TX-25V70T
<pre> AUTO v PAL v SECAM v NTSC 4.43 v NTSC 3.58 v (back to AUTO) </pre>	<pre> AUTO v PAL v NTSC 4.43 v NTSC 3.58 v (back to AUTO) </pre>	<pre> AUTO v PAL v SECAM v NTSC 4.43 v *NTSC 3.58 v (back to AUTO) </pre>

***Note:**
NTSC 3.58 Indicator is only for AV mode.

3

This returns the set to the normal viewing condition after 10 seconds.

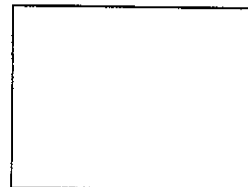

General Operation

Sound System Selection

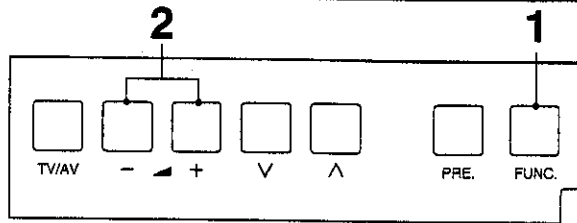

This function is used only in the TV mode, and is not applicable in AV Mode.
When the sound is not clear or no sound is produced on a Programme Number.

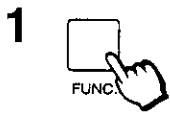

By pushing the "FUNC. (FUNCTION)" Button, you can select the Sound System Selection Mode.

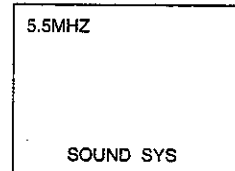

Sound System Selection mode

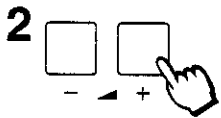

Push the Volume Up "+" Button repeatedly until the optimum sound is obtained.

You may improve the Sound System condition.

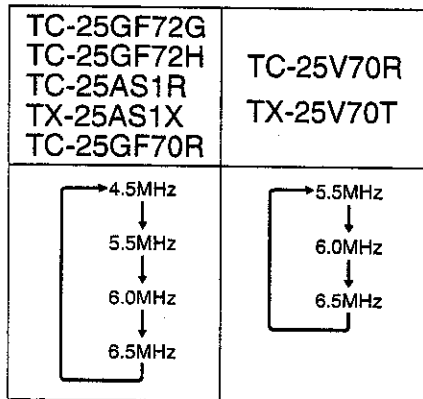

3

This returns the set to the normal viewing condition after 10 seconds.

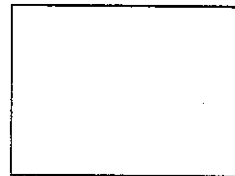

Advanced Remote Control Operation

Stereo Reception (For TC-25GF72G, TC-25GF72H, TX-25AS1X)

1



Stereo/Bilingual Sound Selection Button
Sound output modes can be selected by pushing the "Sound Selection" Button.

"STEREO" (if transmitted), "BILINGUAL" (if transmitted) and "MONO" modes can be selected using this button.

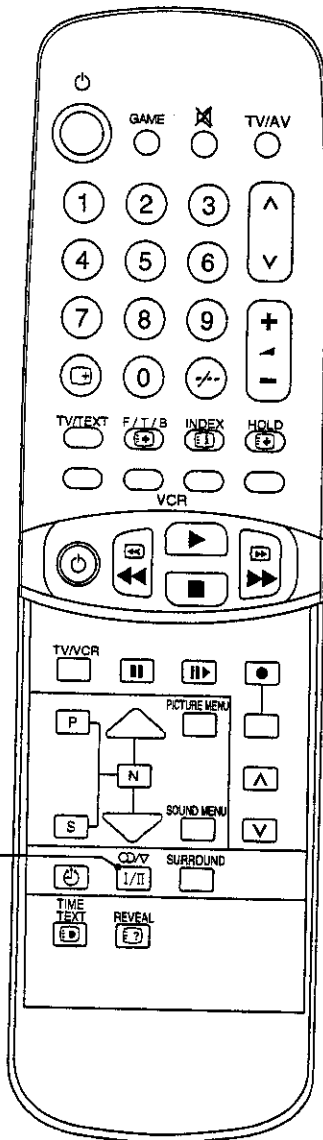



Model No.	Type of STEREO		
	NICAM		A2 (German)
	I	B, G	
TC-25GF72G	*	*	
TC-25GF72H	*	*	
TX-25AS1X		*	*

Note:

- (1) The "NICAM" stereo TV sound transmission system is used in the following countries; New Zealand, Singapore and Hong Kong. The "A2 (German)" stereo/bilingual TV sound transmission system is used in the following countries; Australia, Malaysia, Thailand, Indonesia, etc. (for TX-25AS1X)
- (2) If the stereo signal is weak or the receiving conditions are poor or if STEREO: MONO automatic switching occurs, it is recommended to switch to the "Mono" Mode. When the broadcasting mode changes to "STEREO", "DUAL", or "MONO" after you have selected "MONO" mode, change over to either "STEREO" or "MAIN" Modes will be made automatically. "DUAL" also known as "BILINGUAL" mode is not currently transmitted in some countries.

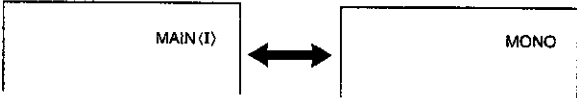
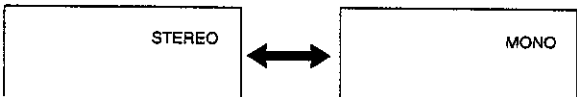
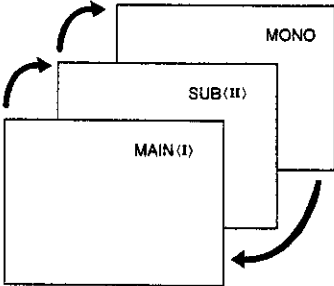
Advanced Remote Control Operation

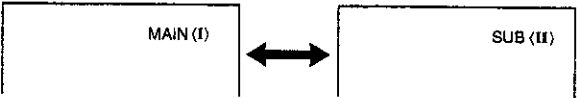
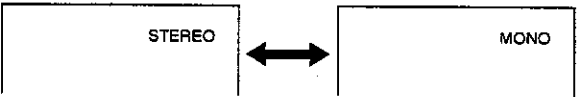
Type of Stereo	Type of broadcast	On-screen indication	Remark
NICAM Digital Stereo	Regular broadcast (Standard Audio)		Normal use
	Regular + NICAM MONO I (MAIN(I))		You can select either the "MAIN(I)" or "MONO" audio signal.
	NICAM STEREO		You can select either the "STEREO" or "MONO" mode.
	NICAM DUAL MONO (MAIN(I)/SUB(II))		You can select either the "MAIN(I), SUB(II) or MONO".
A2 (German) Stereo	Regular broadcast (Standard Audio)		Normal use
	BILINGUAL or DUAL MONO: MAIN(I)/SUB(II)		You can select either the "MAIN(I)" or "SUB(II)" audio signal.
	STEREO		You can select either the "STEREO" or "MONO" mode.

Note:

- (1) Even when the contents of the receiving signal undergo changes, selection mode is kept intact.
- (2) When the receiving conditions deteriorate, listening will be easier if the mode is set to the "MONO" position, using the Stereo/Bilingual Sound selection button as shown on page 28.
- (3) "DUAL", also known as "DUAL MONO" or as "BILINGUAL" is not currently transmitted in some countries.

Advanced Remote Control Operation

Surround Operation

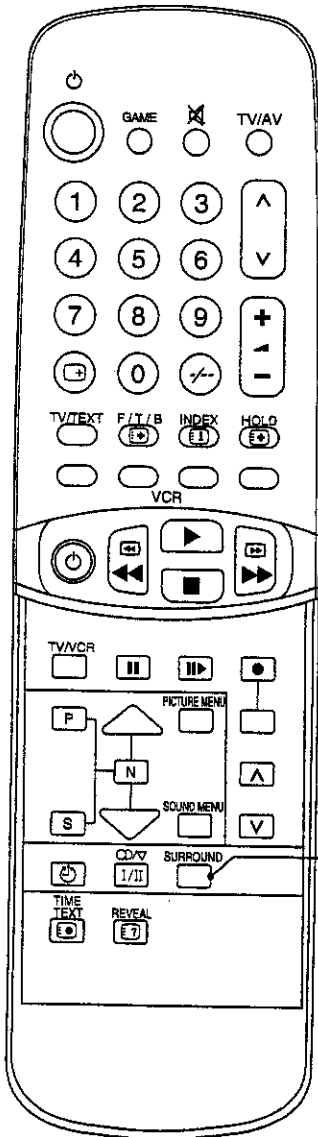
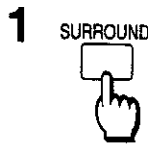

Surround Button

The benefits of surround sound are enormous. With additional speakers you can be completely enveloped in sound; just as if you were at a concert hall or cinema.

The surround effect does operate without external surround speakers, but is enhanced when they are connected. Such near surround speakers should not be sited in direct proximity to the listeners.

On-Screen display during surround mode.

	Type of broadcast	On-screen display
TV Mode	• MONO (Including STEREO switched to MONO by you) and BILINGUAL	SURROUND OFF
	• STEREO (For TC-25GF72G TC-25GF72H TX-25AS1X)	SURROUND ON ↕ SURROUND OFF
AV Mode	• Select the AV mode (AV1, AV2)	SURROUND ON ↓ SURROUND OFF

Note: If the stereo signal is poor or the receiving conditions are not optimum or if STEREO: MONO automatic switching occurs, it is recommended that "STEREO" switch to MONO (Refer to page 28) be used. If problems or unusual sudden effects are encountered in any of the surround modes, it is recommended that "SURROUND OFF" be selected.

Advanced Remote Control Operation

Picture Menu Operation

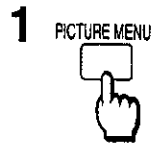

By pushing the "PICTURE MENU" Button, you can sequentially select the Picture Menus as shown below.

On-Screen	Function
DYNAMIC	For watching in brighter environments. This menu selects a higher than normal level of Brightness and Contrast.
STANDARD	For watching in normal (evening lighting) environments. This menu selects the normal level of Brightness and Contrast.
SOFT	For watching in a dark room. This menu selects reduced levels of Brightness and Contrast.

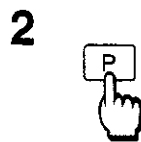
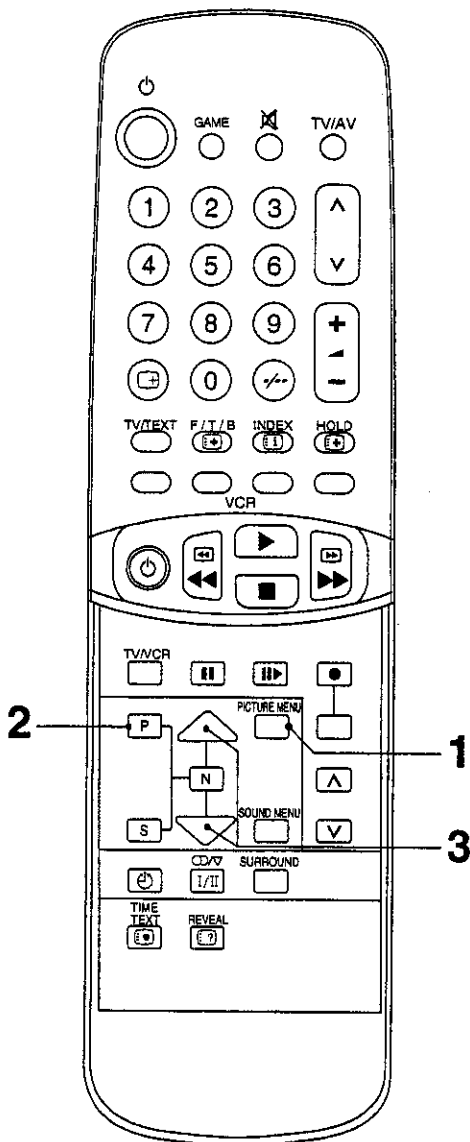

By pushing the Picture Control Function button repeatedly, the on-screen display will be changed.

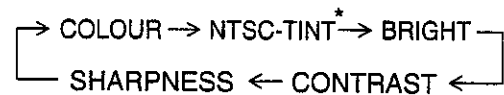

***Note:**

The picture can only be adjusted when the NTSC-TINT is receiving an NTSC signal.

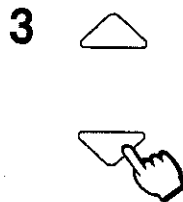

Push the level Up "+" or Down "-" buttons during display to adjust the level of the selected function.

Helpful Hint

- (1) You can change the level of each Function (COLOUR, NTSC-TINT, BRIGHT, CONTRAST, SHARPNESS) for each picture menu.
- (2) Picture menu mode will be memorized for each TV, AV1, AV2, and GAME mode.

Advanced Remote Control Operation

Sound Menu Operation

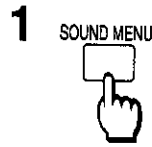

By pushing the "SOUND MENU" Button, you can sequentially select the Sound Menus as shown below.

On-Screen	Function
MUSIC	For music programmes for example.
SPEECH	For News programmes for example.

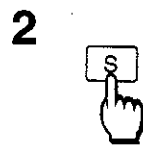

By pushing the Sound Control Function button repeatedly, the on-screen display will be changed.

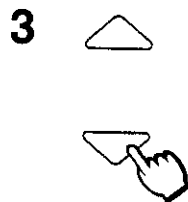
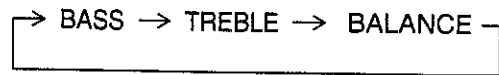

Push the level Up "+" or Down "-" buttons during display to adjust the level of the selected function.

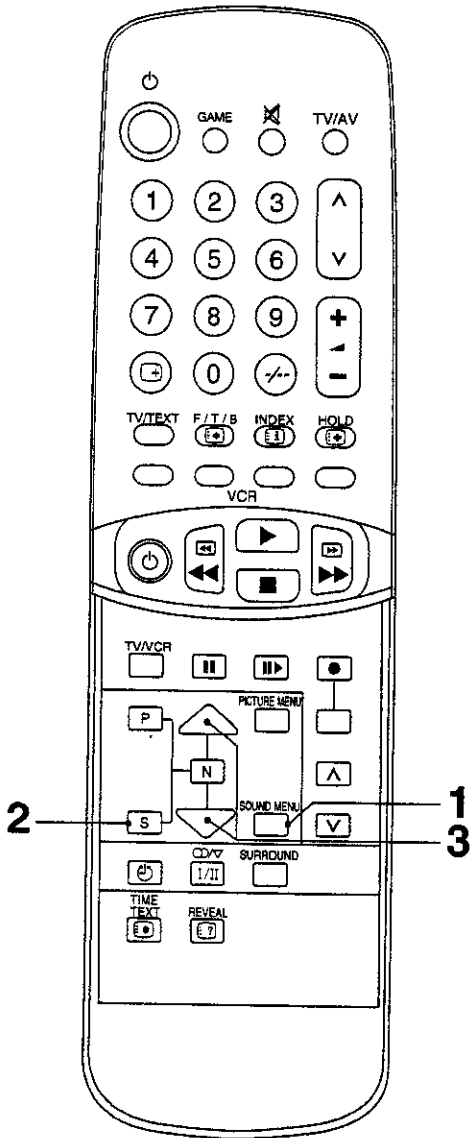

Helpful Hint

- (1) You can change the level of each Function (BASS, TREBLE, BALANCE) for each Sound Menu.
- (2) Sound menu mode will be memorized for each TV, AV1, AV2, and GAME mode.

Teletext Operation

(For TX-25AS1X, TX-25V70T)

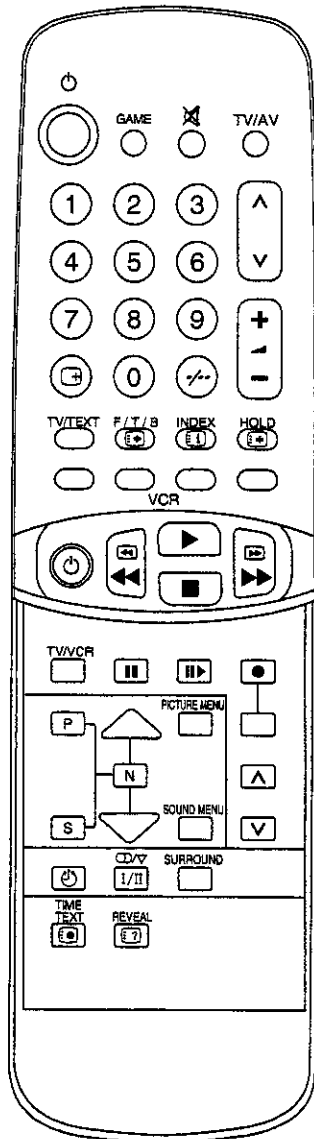

- Teletext features may vary depending on the Broadcasting Companies and is only available if the channel selected is transmitting Teletext.
- When in teletext mode, the volume may still be altered to the desired listening level.

What is FASTEXT?

In FASTEXT mode, four differently coloured subjects are situated at the bottom of the display. To access more information about one of these subjects, push the appropriately coloured button. This facility enables fast access to information of the subjects shown.

What are the advantages?

- Page selection at the touch of a Colour-coded Button.
- Easy to use step-by-step selection of the topical subject.
- Reduction of waiting time.
- Page status line at bottom of screen so you always know which Button will take you to the desired information.

Teletext Operation

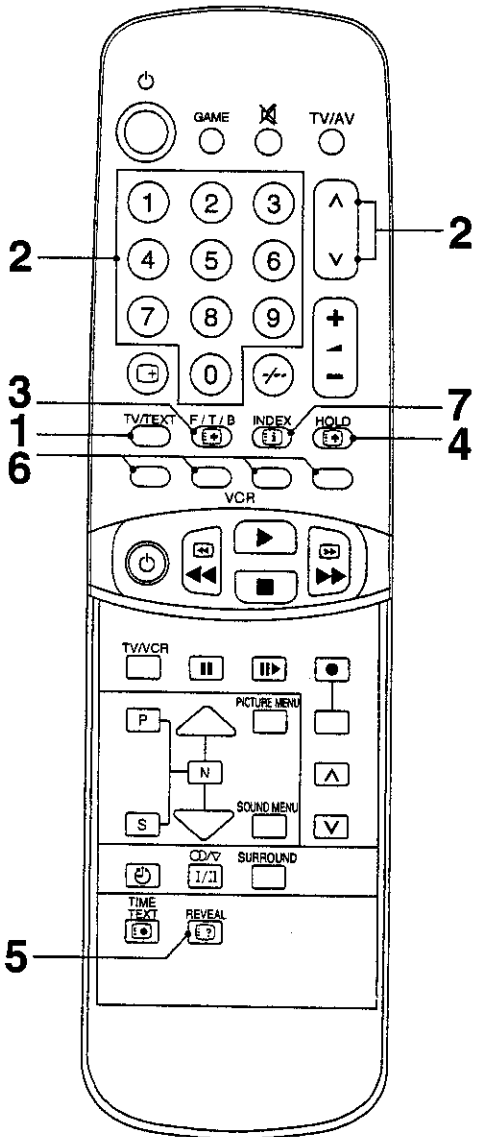

TV/Teletext mode

By pushing the "TV/TEXT" Button, to change the TV/Teletext mode as follows.

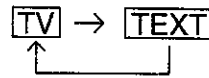

2

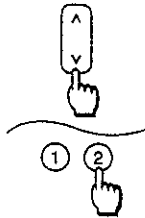

Page Selection

Pages can be selected in two ways:

- a) Push the Up/Down Buttons to increase or decrease the page number by one.
- b) By entering the page number, using 0-9 on the remote control.

3



Full/Top/Bottom

Push to expand the Top half of the page. Push again to expand the Bottom half. Push again to return to normal (FULL) size.

4



Hold

Push to hold the current page. Push again to cancel the hold.

5



Reveal

Push to reveal hidden words e.g. quiz page answers. Push again to hide.

6

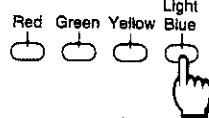

Colour-Coded Buttons

In FASTEXT mode these correspond to the differently coloured subjects.

7



Index

Push INDEX to return to the main index page.

Teletext Operation

Sub Coded Page Access

When teletext information exceeds more than one page, it may take some time for the automatic changing of the sub pages to reach the sub page you require. It is possible to enter your required sub page and continue watching the normal programme until the correct sub page is found.

Select the required page number using Buttons 0-9.

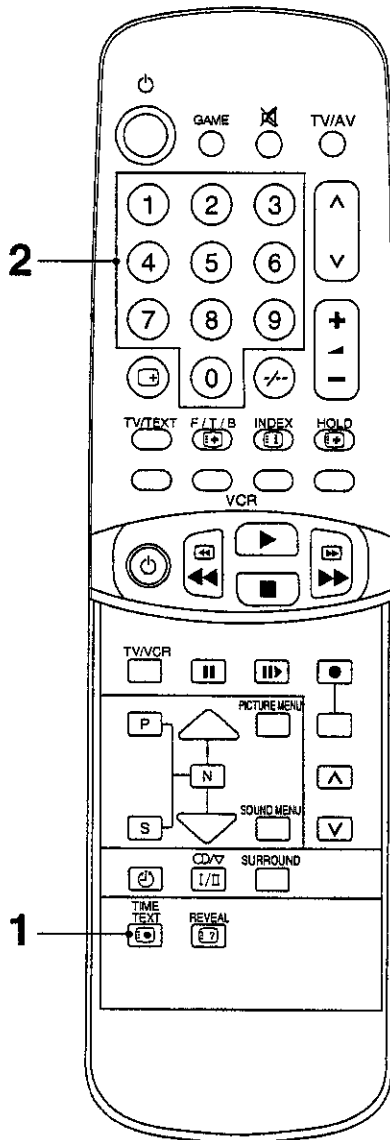

1 Push TIME TEXT "----" will be displayed.



2 Enter desired sub page number before the "----" disappears.

To select page 6 enter 0, 0, 0 and 6.

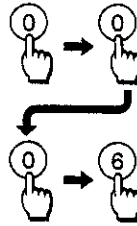

Operation of the VCR

Your Remote Control is designed to be used with selected Panasonic/National VCR's.
Some model VCR's have different functions, so please refer to the individual VCR Instruction Booklet to ensure compatibility.

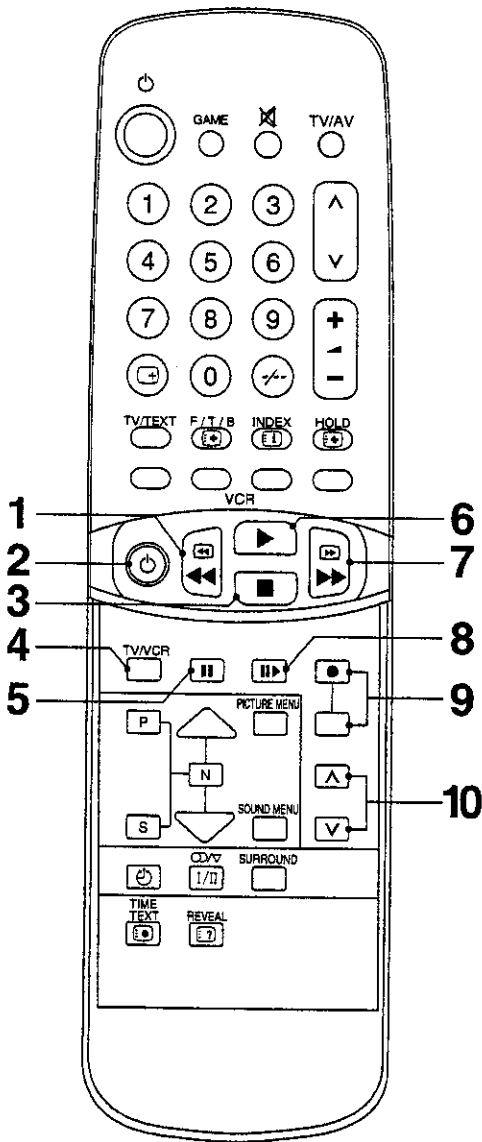

- | | | |
|-----------|--|---|
| 1 | | Rew (Rewind)/Review Button |
| 2 | | VCR Power Button |
| 3 | | Stop Button |
| 4 | | TV/VCR Selection Button |
| 5 | | Pause/Still Button |
| 6 | | Play Button |
| 7 | | FF (Fast Forward)/Cue Button |
| 8 | | Still Advance Button |
| 9 | | Rec (Record) Button |
| 10 | | Programme Number Up and Down Buttons for VCR |

Open the cover
(Push down and Slide the cover out.)

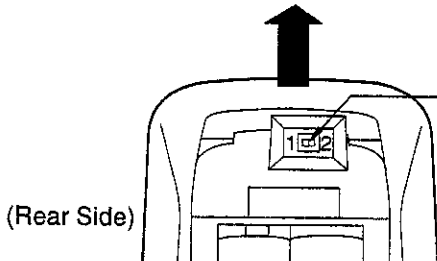













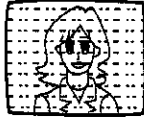

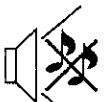

VCR Mode Select Switch

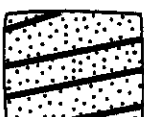
When used with normal Panasonic/National VCR's, set this switch to "2".
If operation cannot be carried out, set the switch to "1".

Troubleshooting

Before you call for service, determine the symptoms and make a few simple checks as shown below.

Symptoms		Checks
Picture	Sound	
 Snowy Picture	 Noisy Sound	Aerial Location, direction or Connections
 Multiple Image	 Normal Sound	Aerial Location, direction or Connections
 Interference	 Noisy Sound	Electrical Appliances Cars/Motorcycles Fluorescent Lamps
 Normal Picture	 No Sound	Volume (Check whether the mute function has been activated on the Remote Control.) Sound System (Refer to page 19)
 No Picture	 No Sound	Not plugged into AC outlet Not switched on Contrast and Brightness/Volume setting (Check by pushing the Power Switch or Stand-by Button on the Remote Control.)
 No Colour	 Normal Sound	Colour Control Colour System (Refer to page 26)
 Scrambled	 Normal or Weak Sound	Retune Channels
 Coloured Patches	 Normal Sound	Magnetic interference from unshielded equipment TV set moved while "ON" Turn the TV set off for 30 mins, using the "Main Power" Button on the TV set.
 No Colour	 Noisy Sound	Colour System (Refer to page 26) Sound System (Refer to page 27)

Specifications

Power Source

TC-25GF72G, TC-25GF72H	TX-25AS1X, TC-25AS1R	TC-25GF70R	TX-25V70T, TC-25V70R
AC Auto 110V/220V, 50/60Hz	AC Auto 110V/240V, 50/60Hz	AC 220V, 50Hz	AC 220V, 50/60Hz

Power Consumption

TC-25GF72G, TC-25GF72H, TX-25AS1X, TC-25AS1R	TC-25GF70R, TX-25V70T, TC-25V70R
140 W	136 W
Stand-by condition 6 W	Stand-by condition 6 W

Receiving System

	Systems	TC-25GF70R	TC-25GF72G TC-25GF72H TC-25AS1R TX-25AS1X	TC-25V70R TX-25V70T	Function
1	PAL B, G, H	○	○	○	Reception of broadcast transmissions and playback from Video Cassette Tape Recorders
2	PAL I	○	○	○	
3	PAL D, K	○	○	○	
4	SECAM B, G	-	○	○	
5	SECAM D, K	-	○	○	
6	SECAM K1	-	○	○	
7	NTSC M (NTSC 3.58/4.5MHz)	○	○	-	
8	NTSC 4.43/5.5MHz	○	○	○	Playback from Special VCR's
9	NTSC 4.43/6.0MHz	○	○	○	
10	NTSC 4.43/6.5MHz	○	○	○	
11	NTSC 3.58/5.5MHz	○	○	-	
12	NTSC 3.58/6.0MHz	○	○	-	
13	NTSC 3.58/6.5MHz	○	○	-	
14	SECAM I	-	○	○	
15	PAL 60Hz/5.5MHz	○	○	○	Playback from Special Disc Players and Special VCR's
16	PAL 60Hz/6.0MHz	○	○	○	
17	PAL 60Hz/6.5MHz	○	○	○	

Receiving Channels

TC-25GF72G/TC-25GF72H/TC-25AS1R/TX-25AS1X

VHF BAND	UHF BAND	CATV
2-12 (PAL/SECAM B, K1)	21-69 (PAL G, H, I)	S1-S20 (OSCAR)
0-12 (PAL B AUST.)	(SECAM G, K, K1)	S21-S41 (HYPER)
1- 9 (PAL B N. Z)	28-69 (PAL B AUST.)	1-125 (U. S. A.)
1-12 (PAL/SECAM D)	13-57 (PAL D, K)	C13-C49 (JAPAN)
1-12 (NTSC M JAPAN)	13-62 (NTSC M JAPAN)	5A, 9A (AUST.)
2-13 (NTSC M U. S. A.)	14-69 (NTSC M U. S. A.)	Z1-Z37 (CHINA)

TC-25GF70R

VHF BAND	UHF BAND	CATV
2-12 (PAL B)	21-69 (PAL G, H, I)	S1-S20 (OSCAR)
0-12 (PAL B AUST.)	28-69 (PAL B AUST.)	S21-S41 (HYPER)
1- 9 (PAL B N. Z)	13-57 (PAL D, K)	1-125 (U. S. A.)
1-12 (PAL D)	13-62 (NTSC M JAPAN)	C13-C49 (JAPAN)
1-12 (NTSC M JAPAN)	14-69 (NTSC M U. S. A.)	5A, 9A (AUST.)
2-13 (NTSC M U. S. A.)		Z1-Z37 (CHINA)

TC-25V70R, TX-25V70T

VHF BAND	UHF BAND	CATV
2-12 (PAL/SECAM B, K1)	21-69 (PAL G, H, I)	S1-S20 (OSCAR)
0-12 (PAL B AUST.)	(SECAM G, K, K1)	S21-S41 (HYPER)
1- 9 (PAL B N. Z)	28-69 (PAL B AUST.)	5A, 9A (AUST.)
1-12 (PAL/SECAM D)	13-57 (PAL D, K)	Z1-Z37 (CHINA)

Specifications

Receiving Stereo Sound System

NICAM B, G NICAM I (For TC-25GF72G, TC-25GF72H)
 NICAM B, G A2 (German) (For TX-25AS1X)

Tuning System

Voltage synthesizer
 Auto Search Tuning 100 Position

Picture Tube

Overall Picture tube measured diagonally 63 cm
 Viewable Picture tube measured diagonally 59 cm
 CRT Deflection 110°

Audio Output

5 W (Max.) × 2

Aerial Impedance

75Ω Unbalanced coaxial

Video/Audio Terminals

AV1	S-Video In	Y: 1.0 Vp-p, 75Ω	AV2	Video In	1 Vp-p, 75Ω
		C: 0.3 Vp-p, 75Ω		Audio In	Approx. 400mV
	Video In	1 Vp-p, 75Ω	Monitor Out	Video Out	1 Vp-p, 75Ω
	Audio In	Approx. 400mV		Audio Out	Approx. 400mV

Surround Terminals Impedance 8~16Ω (For TC-25GF72H)

Accessories Supplied

Remote Control Transmitter TX-25AS1X, TX-25V70T EUR51973
 TC-25GF72G, TC-25GF72H EUR51974
 TC-25GF70R, TC-25AS1R, TC-25V70R EUR51975

R6 (AA) Battery × 2

Dimensions (W × D × H)

623 mm × 478 mm × 523 mm

Weight (Mass)

31 kg (Net)

Note:

Design and Specifications are subject to change without notice.
 Weight and Dimensions shown are approximate.

Customer's Record

The serial number of this product can be found on its rear cover. You should note this serial number in the space provided below and retain this book plus your purchase receipt as a permanent record of your purchase to aid in identification in the event of theft or loss, and for Warranty Service purposes.

Model Number _____

Serial Number _____

Matsushita Electric Industrial Co., Ltd.

Central P.O. Box 288, Osaka 530-91, Japan

Printed in Japan
S0796