

Panasonic

Operating Instruction

Colour Television
TC-21S70M2

Please read the operating instructions completely before operating this set.

TQB4G0441

Dear Panasonic customer

Welcome to the Panasonic family of customers. We hope that you will have many years of enjoyment from your new colour television.

Safety Instructions

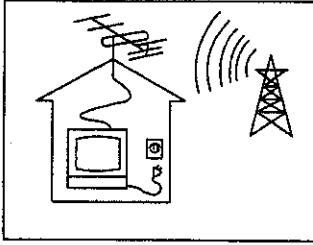

The TV set can be operated on AC SINGLE 220-240V, 50Hz.

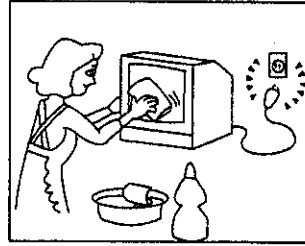

The cabinet and picture tube can be kept in good condition by simply wiping with a clean, soft cloth moistened with mild detergent and water. Do not use solutions containing benzol, petroleum or a chemical cloth. For safety, remove the plug from the wall outlet.

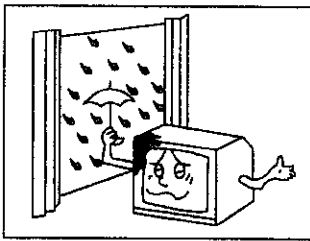

To prevent damage which may result in fire or electrical shock, do not expose the TV set to rain or excessive moisture.

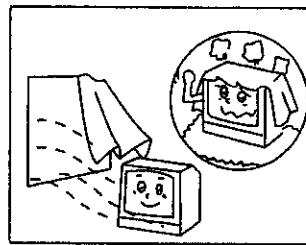

Adequate ventilation is essential to prevent failure of electrical components.

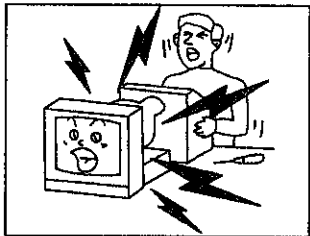

Do not remove the rear cover, as live parts are accessible when it is removed.

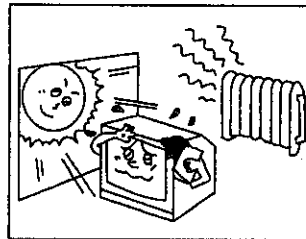

Avoid exposing the TV set to direct sunlight and other source of heat.

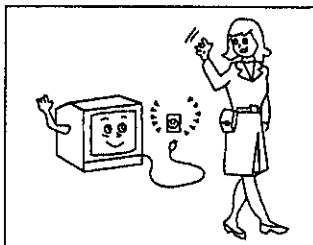

Remove the plug from the wall outlet (Power point) when the TV set is not used for a prolonged period of time.

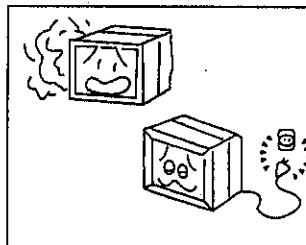

Do not use this set if abnormal operation occurs.
EX: smoke, odd sounds or smells, turn the power switch off and disconnect the AC power if you notice any unusual operation.

Location of Controls (TV)

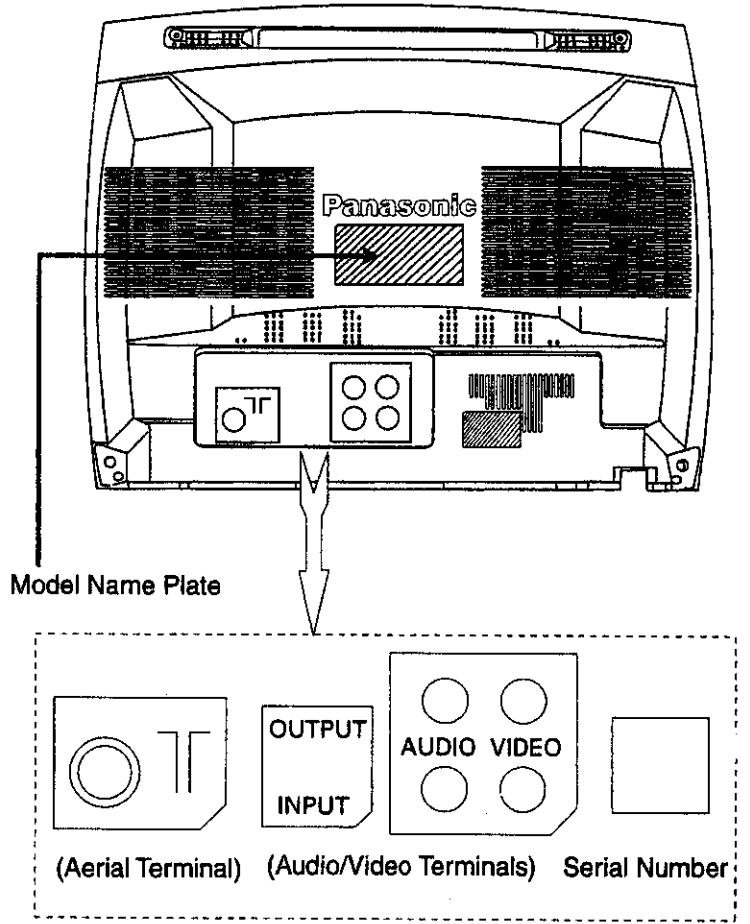
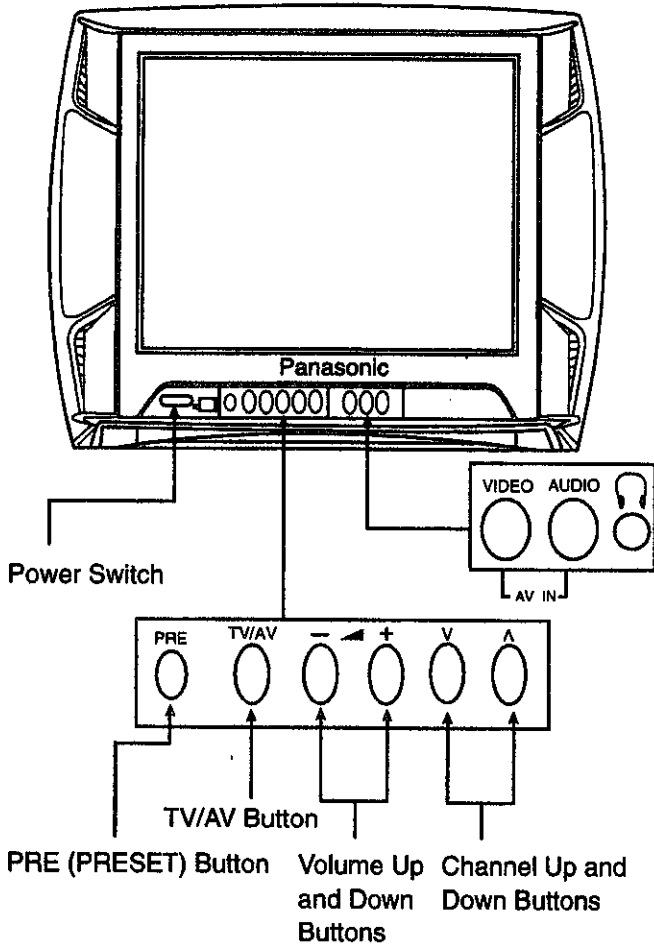

Location of Controls (TV)

Plug the headphone jack as shown below:

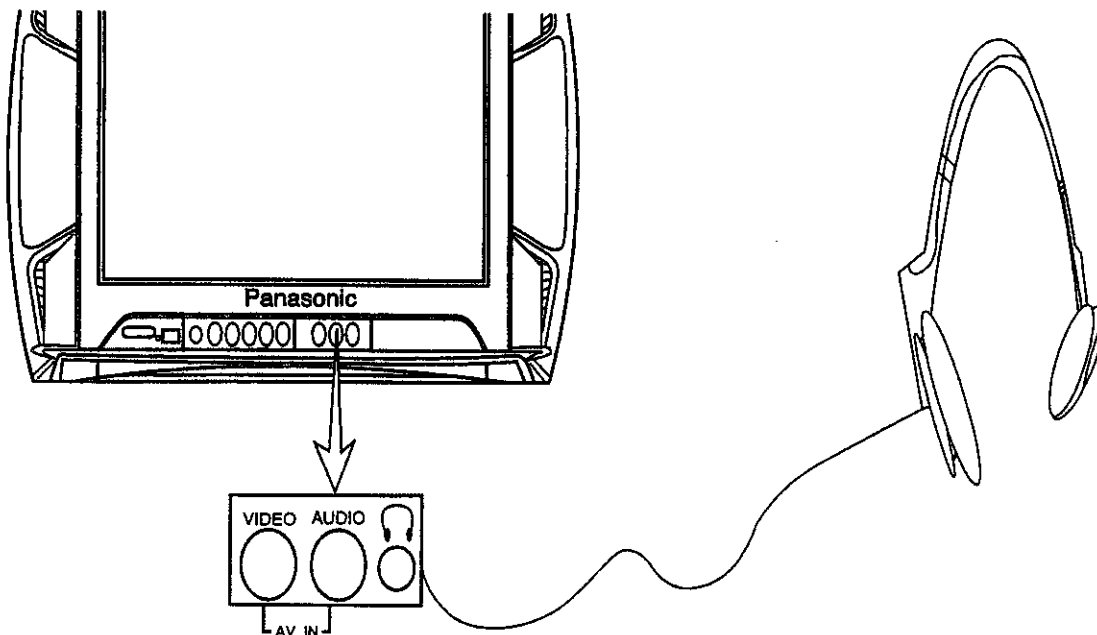

Remote Control Transmitter

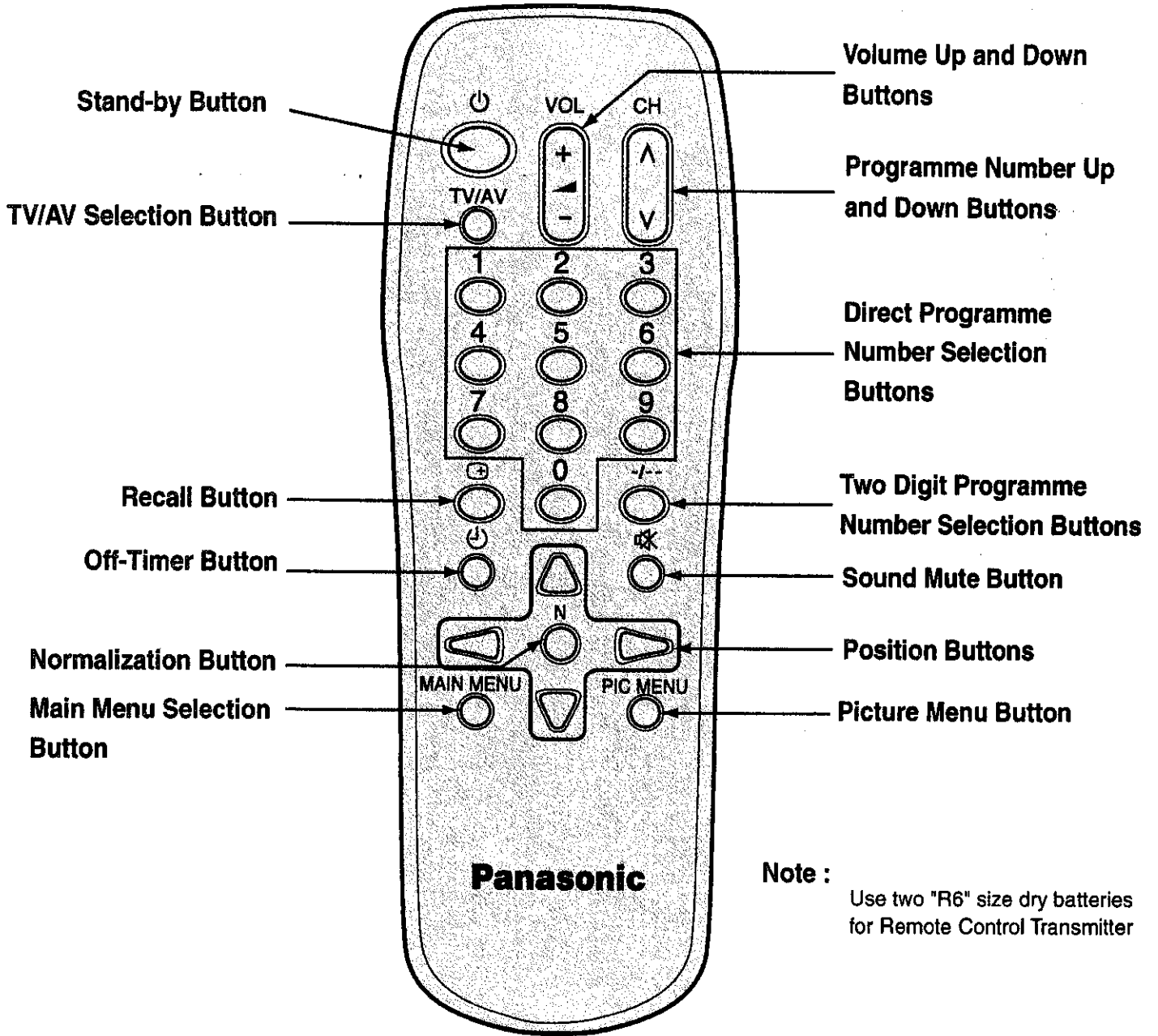

Note : Use two "R6" size dry batteries for Remote Control Transmitter

General Operation

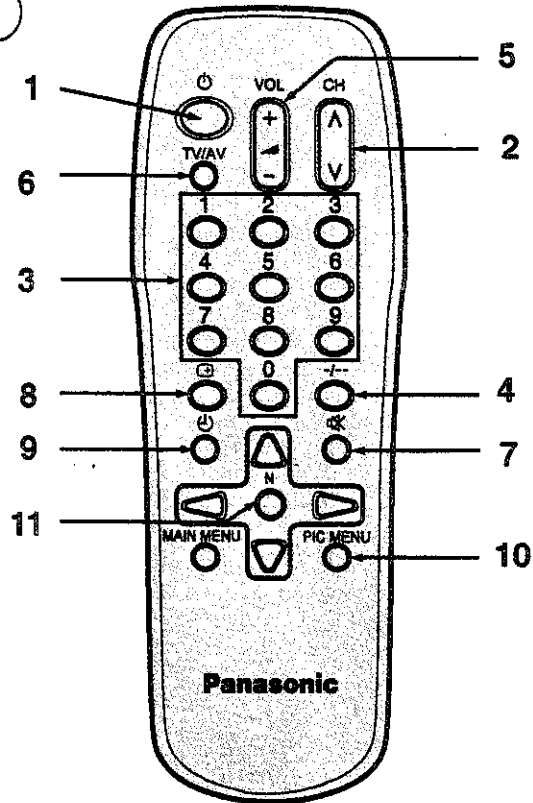

To Switch Power on/off

The TV set must be switched on at the wall outlet and at the Main power switch.

1.

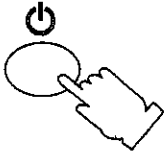

Press this button to turn the TV set ON, from stand-by mode. Press it again to turn off.

Note :

When in the stand - by condition, it is possible to turn the TV set on by pushing the Direct Programme Number Selection button (0-9) or the Programme Number Up and Down button.

2.

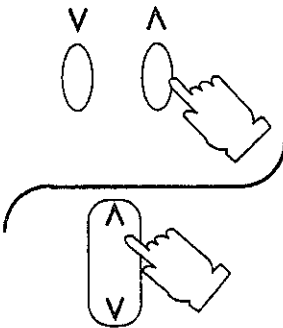

Programme Number Selection

Press the programme number Up "▲" or down "▼" Button to select the next higher or lower programme number.

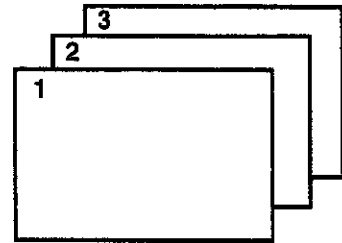

3.

Direct Programme Number Selection

(0 - 9)

e. g. To select programme number "1", press the "1" button.

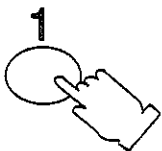

General Operation

4. Two Digit Programme Number Selection

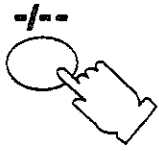

e.g. To select Programme Number "24".

Push the button.

Push the button.

Push the button.

Setting range 0 ~ 99

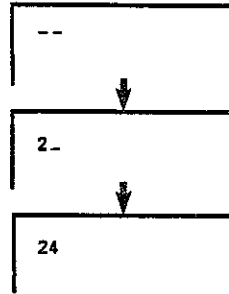

You can select a two Digit Programme Number.

5. Volume Adjustment

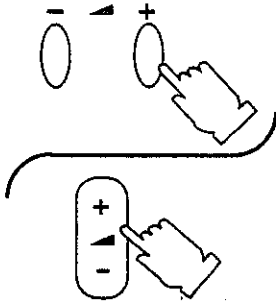

Push the Volume Up or Down button to increase or decrease the sound volume level.



Note :

The on screen display will indicate both numerically and graphically the volume level. Numeric levels start at " 0 " for zero or no sound, and will increase up to 63 which is the maximum sound level.

6. TV / AV Selection

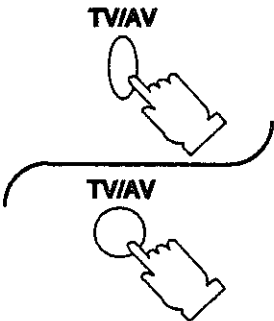

Push the " TV/AV " button to select TV and AV input signal.

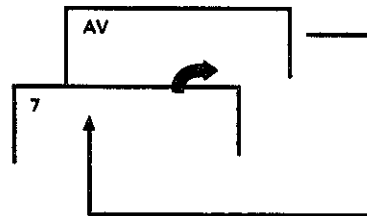

7. Sound Mute Button

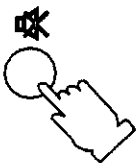

Push the this button to mute the Sound completely.
Push the button once again to restore the previous sound level, and cancel the mute.

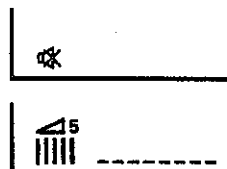

The " Mute " symbol will appear. (Colour changes to red)

8. Recall Button

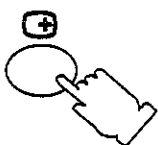

Push the RECALL button to display the current system status. Press this button until display is cancelled.

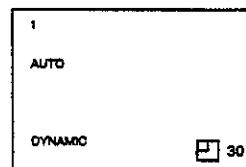

General Operation

9. Off Timer Button

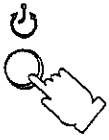

The TV set may be preset to switch to stand-by after a fixed period.
By pressing "Off-Timer" button, you can select the preset time either 30, 60, or 90 minutes.

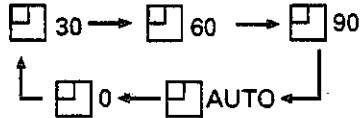

When the off-timer reaches its last 3 minutes, it starts blinking before going to stand-by condition.

Note :

Setting Off-timer to AUTO mode.

If the set is not switched off, when the TV station ends broadcasting, it will automatically go to the stand-by condition after 5 minutes. This AUTO mode will not operate when the TV receiver is in AV mode.

How to cancel the OFF-timer setting:

1. Set the preset time condition to "0" mode by pressing the Off - timer button.
2. Turning the TV set off.

10. Picture Menu

PIC MENU



By pressing the PICTURE MENU button, you can sequentially select the Picture menus as shown below:

On-screen	Function
DYNAMIC	For watching in brighter environments. This menu selects a higher than normal level of brightness and contrast.
STANDARD	For watching in normal (evening) environments. This menu selects normal level of brightness and contrast.
SOFT	For watching in dark environments. This menu selects reduced level of brightness and contrast.



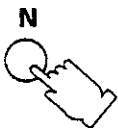





































11. Normal (N) Button



This button can be used for setting the Colour, Brightness, Contrast, Sharpness, Tone and Colour Temp. When this button is pressed, all functions setting are reset to the factory preset level.

Flow Chart of Main Menu

When the " MAIN MENU " button is pushed at the main menu screen, the screen display will return to the normal viewing condition. When the " MAIN MENU " button is pushed at each MENU screen (Picture, Sound, Features, Language, Preset), the screen display will return to the Main Menu screen.

Push	MAIN MENU 				
Select	 				
Symbol Mark					
On-Screen Indication	PICTURE	SOUND	FEATURES	LANGUAGE ENGLISH 中文 РУССКИЙ العربية	PRESET
Push					
On-Screen Indication (example)	<p style="text-align: center;">DYNAMIC</p> <div style="border: 1px solid black; padding: 2px; margin-bottom: 5px;">  32 COLOUR  32 NTSC-TINT  32 BRIGHT  63 CONTRAST  32 SHARPNESS STD COLOUR TEMP </div> <p style="text-align: center;">↑</p> <div style="border: 1px solid black; padding: 2px; margin-bottom: 5px;">  32 COLOUR  32 NTSC-TINT  32 BRIGHT  63 CONTRAST  32 SHARPNESS STD COLOUR TEMP </div> <p style="text-align: center;">↑</p> <div style="border: 1px solid black; padding: 2px; margin-bottom: 5px;">  32 COLOUR  32 NTSC-TINT  32 BRIGHT  63 CONTRAST  32 SHARPNESS STD COLOUR TEMP </div> <p style="text-align: center;">↑</p> <div style="border: 1px solid black; padding: 2px; margin-bottom: 5px;">  32 COLOUR  32 NTSC-TINT  32 BRIGHT  63 CONTRAST  32 SHARPNESS STD COLOUR TEMP </div> <p style="text-align: center;">↑</p> <div style="border: 1px solid black; padding: 2px; margin-bottom: 5px;">  32 COLOUR  32 NTSC-TINT  32 BRIGHT  63 CONTRAST  32 SHARPNESS STD COLOUR TEMP </div> <p style="text-align: center;">↑</p> <div style="border: 1px solid black; padding: 2px; margin-bottom: 5px;">  32 COLOUR  32 NTSC-TINT  32 BRIGHT  63 CONTRAST  32 SHARPNESS STD COLOUR TEMP </div>	 63 TONE	<div style="border: 1px solid black; padding: 2px; margin-bottom: 5px;"> BLUE BACK ON CH COLOUR SET STD CHILD LOCK OFF </div> <p style="text-align: center;">↑</p> <div style="border: 1px solid black; padding: 2px; margin-bottom: 5px;"> BLUE BACK ON CH COLOUR SET STD CHILD LOCK OFF </div> <p style="text-align: center;">↑</p> <div style="border: 1px solid black; padding: 2px; margin-bottom: 5px;"> BLUE BACK ON CH COLOUR SET STD CHILD LOCK OFF </div>	<div style="border: 1px solid black; padding: 2px; margin-bottom: 5px;"> 语言 ENGLISH 中文 РУССКИЙ العربية </div> <p style="text-align: center;">↑</p> <div style="border: 1px solid black; padding: 2px; margin-bottom: 5px;"> ЯЗЫК ENGLISH 中文 РУССКИЙ العربية </div> <p style="text-align: center;">↑</p> <div style="border: 1px solid black; padding: 2px; margin-bottom: 5px;"> اللغة ENGLISH 中文 РУССКИЙ العربية </div>	<div style="border: 1px solid black; padding: 2px; margin-bottom: 5px;"> 88 AUTO SEARCH MANUAL SEARCH COLOUR SYS AUTO FINE TUNE SKIP OFF </div> <p style="text-align: center;">↑</p> <div style="border: 1px solid black; padding: 2px; margin-bottom: 5px;"> 88 AUTO SEARCH MANUAL SEARCH COLOUR SYS AUTO FINE TUNE SKIP OFF </div> <p style="text-align: center;">↑</p> <div style="border: 1px solid black; padding: 2px; margin-bottom: 5px;"> 88 AUTO SEARCH MANUAL SEARCH COLOUR SYS AUTO FINE TUNE SKIP OFF </div> <p style="text-align: center;">↑</p> <div style="border: 1px solid black; padding: 2px; margin-bottom: 5px;"> 88 AUTO SEARCH MANUAL SEARCH COLOUR SYS AUTO FINE TUNE SKIP OFF </div> <p style="text-align: center;">↑</p> <div style="border: 1px solid black; padding: 2px; margin-bottom: 5px;"> 88 AUTO SEARCH MANUAL SEARCH COLOUR SYS AUTO FINE TUNE SKIP OFF </div>

Tuning Procedure

Automatic Search

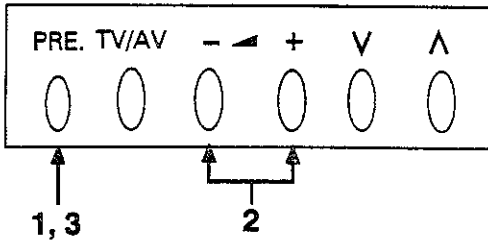

OR

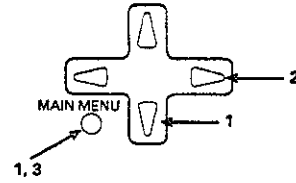

- 1.**  **PRE.** Press the "PRE" (PRESET) button, setting the Automatic search mode.

1

AUTO SEARCH

MANUAL SEARCH

COLOUR SYS AUTO

FINE TUNE

SKIP OFF

Channel Number
Automatic search
condition.

-  Press the "MAIN MENU" and "Position" buttons, until "AUTO SEARCH" is selected.

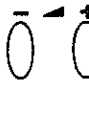
- 2.**  Press the Volume Up "+" button.

0

AUTO SEARCH VL

Search start.

↓

0

AUTO SEARCH

MANUAL SEARCH

COLOUR SYS AUTO

FINE TUNE

SKIP OFF

The best tuning position is
automatically memorized.

- 3.**  **PRE.** Press the "PRE" (PRESET) button 5 times.

This returns the set to the
normal viewing condition.

-  **MAIN MENU** After all stations are tuned, press the "MAIN MENU" button twice.

Helpful Hints

1. If a clear picture with correct colours cannot be obtained when a broadcast or AV signal is received, refer to the "Colour System Selection" operation on page 14.
2. After the Automatic Search operation is finished, press the Channel Number "Up" button to confirm the tuning condition for each Channel Number. If some Channel Numbers are unused, it is possible to skip such Channel Numbers. Please refer to the Channel Number Skip operation on page 12.
3. Repeated pressing of the "PRE." (PRESET) button changes the Preset Menu as follows :

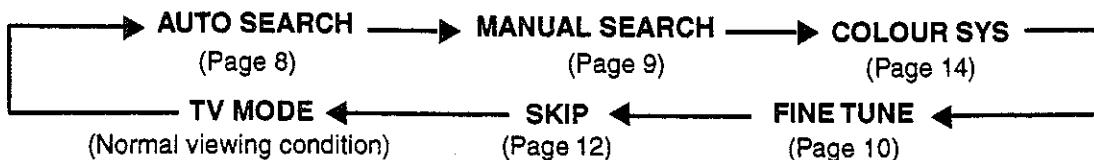

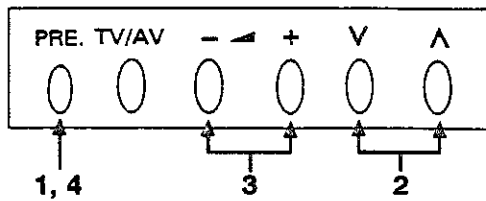

Tuning Procedure

Manual Search

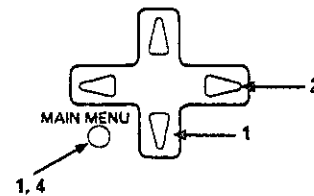

OR



1.  Press the "PRE" (PRESET) button twice, setting the Manual Search mode.

Channel Number Manual search condition.



-  Press the "MAIN MENU" and "Position" buttons, until "MANUAL SEARCH" function is selected.

2.  Press either the Channel Up or Down button.

Select the desired Channel Number.

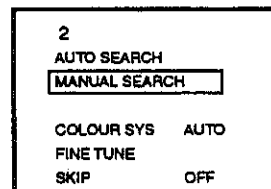

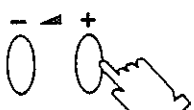
3.  Press the Volume Up "+" or Down "-" button.
Volume "+" : Next higher Channel
Volume "-" : Next lower Channel

Search Start.

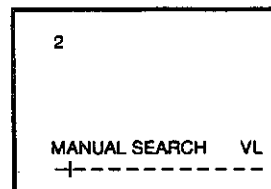

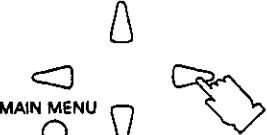
-  Press the Position Left or Right button.
Position left : Next lower Channel.
Position right : Next higher Channel.

The best tuning position is automatically memorized.

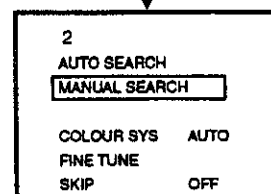

4.  Press the "PRE" (PRESET) button 4 times.

This returns the set to the normal viewing condition.

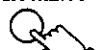
-  Press the "MAIN MENU" button twice.



Helpful Hints

- If a clear picture with correct colours cannot be obtained when a broadcast or AV signal is received, refer to the "Colour System Selection" operation on page 14.
- After the Manual Search operation is finished, press the Channel Number "Up" button to confirm the tuning condition for each Channel Number. If some Channel Numbers are unused, it is possible to skip such Channel Numbers. Please refer to the Channel Number Skip operation on page 12.

Tuning Procedure

Fine Tune

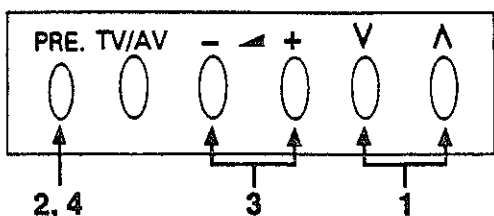

OR

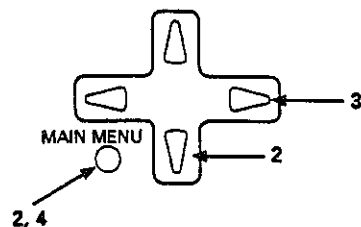

Under normal reception condition, this function is not used. However, in areas of poor reception or constant interference, a slight adjustment on the fine tuning can improve the picture and sound quality.

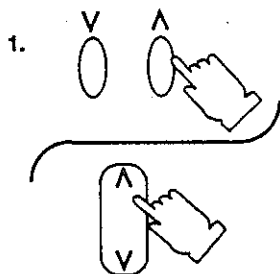

1. Select the channel which you want to try to improve, using the Channel Up or Down buttons.

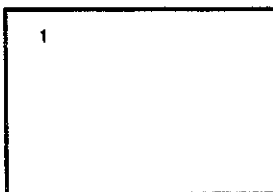

Select the desired Channel Number.



2. Press the "PRE." (PRESET) buttons 4 times, setting the Preset Menu to "Fine Tune".

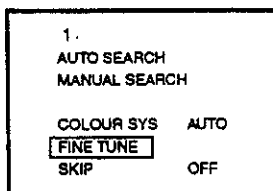

Fine Tune condition.

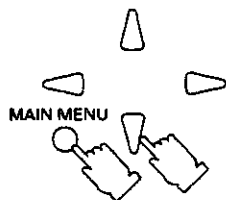

Press the "MAIN MENU" and "Position" buttons, until "FINE TUNE" is selected.

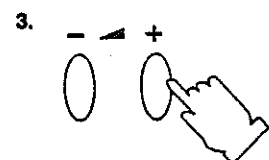

3. Press the Volume Up "+" or Down "-" button until the picture is received.

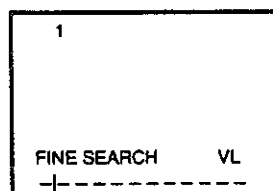

Fine Tune Start.

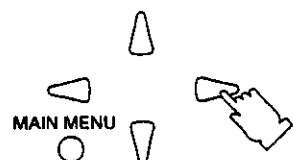

Press the Position Left or Right button until the picture is received.

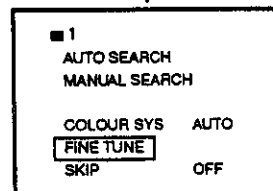

The AFC (Automatic Frequency Control) function is deactivated. The "■" symbol appears to the left of the Channel Number.

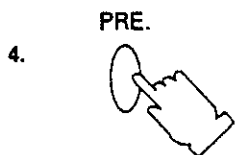

4. Press the "PRE" (PRESET) button 2 times.

This returns the set to the normal viewing condition.

MAIN MENU



After all stations are tuned, press the "MAIN MENU" button twice.

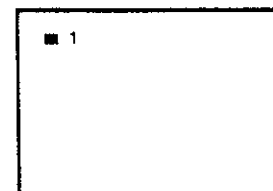

Tuning Procedure

How to cancel the Fine Tuning

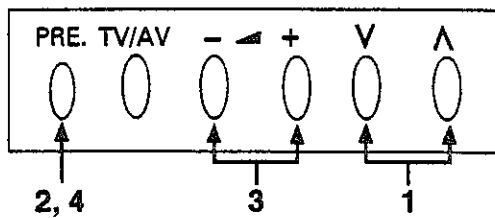

OR

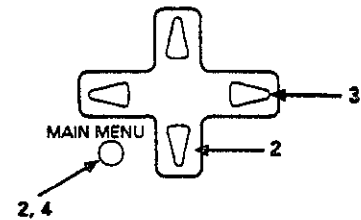

Cancelling previously adjusted (manually) fine tuning, means re – activating the AFC (Automatic Frequency Control) Function, also known as AFT (Automatic Fine Tuning). Re – activating the Automatic Fine Tuning means albaring the set to automatically tune optimum tuning position, for that Channel Number.

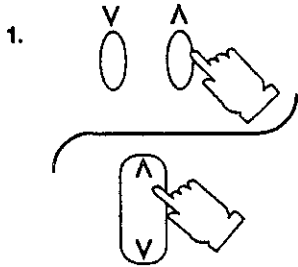

1. Select the "AFC OFF" Channel Number which you want to return to Automatic Frequency Control (Cancel the manual fine tuning).

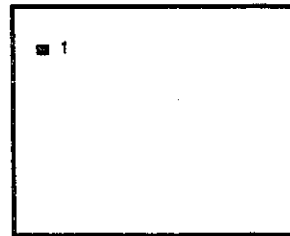

"AFC OFF" Channel Numbers are indicated to you by the "■" symbol to the left of the Channel Number.

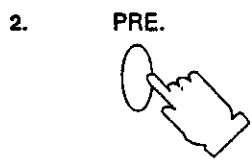

2. Press the "PRE." (PRESET) buttons 2 times, setting the Preset Menu to "MANUAL SEARCH".

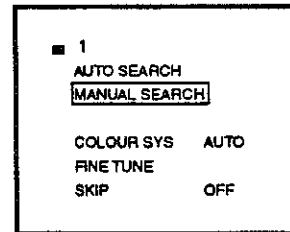

Manual Search condition.

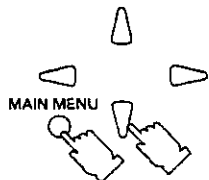

Press the "MAIN MENU" and "Position" buttons, until the Preset Menu to "MANUAL SEARCH".

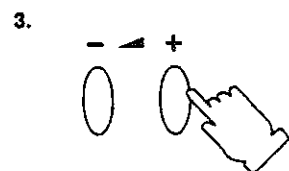

3. Press the Volume Up "+" or Down "-" button briefly.

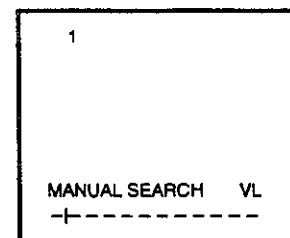

The best tuning position is automatically memorized.

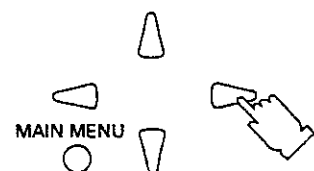

Press the Position Left or Right button briefly.

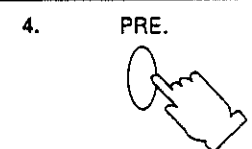
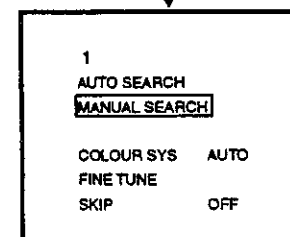

4. Press the "PRE" (PRESET) button 4 times.

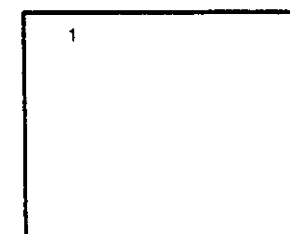

This returns the set to the normal viewing condition.

MAIN MENU

Press the "MAIN MENU" button twice.

Tuning Procedure

Programme Number Skip

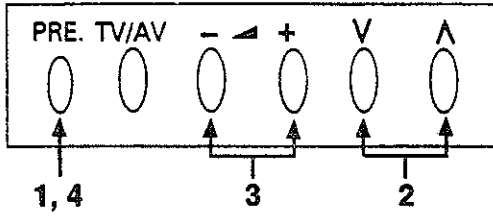

OR

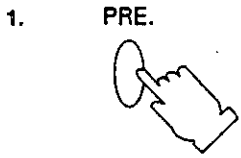
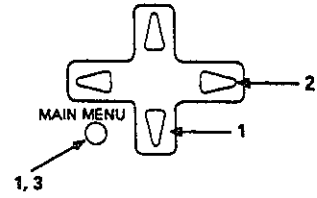

Press the "PRE." (PRESET) buttons 5 times, setting the Preset Menu to "SKIP".

Channel Skip condition.

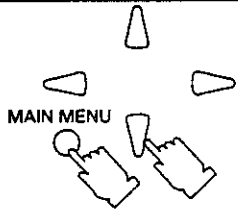
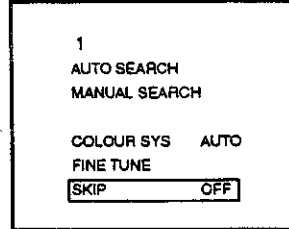

Press the "MAIN MENU" and "Position" buttons, until "SKIP" is selected.

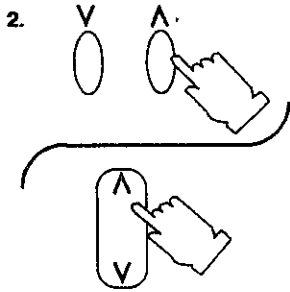

Select a Programme Number you want to skip, by pushing the Channel number Up or Down buttons.

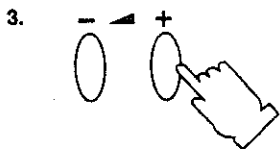
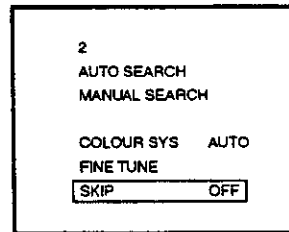

Press the Volume Up " + " or Down " - " button.

The displayed "OFF" condition changes to "ON".

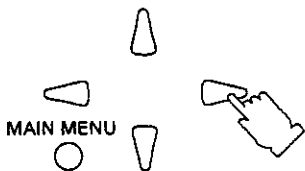
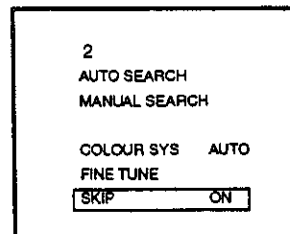

Press the Position Left or Right button.

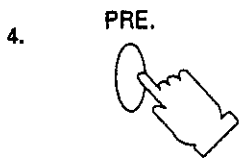

Press the "PRE" button once.

This returns the set to the normal viewing condition.

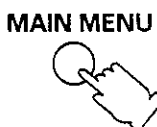

Press the "MAIN MENU" button twice.

Tuning Procedure

How to Cancel the Skip Function.

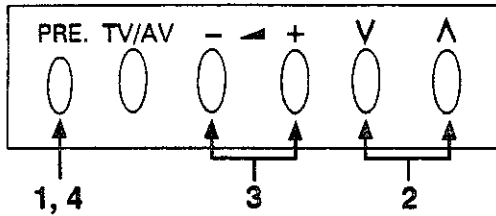

OR

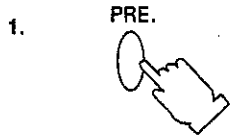
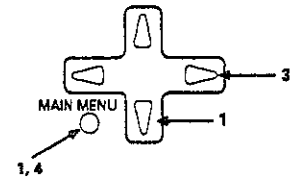

Press the "PRE." (PRESET) buttons 5 times, setting the Preset Menu to "SKIP".

Channel Skip condition.

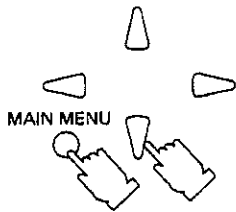
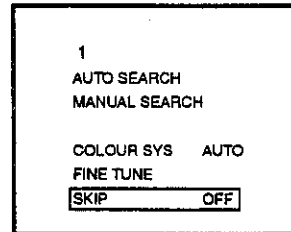

Press the "MAIN MENU" and "Position" buttons, until "SKIP" is selected.

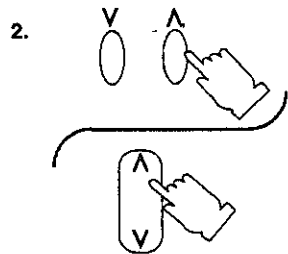

Select the skipped Programme Number, by pressing the Channel Number Up or Down buttons.

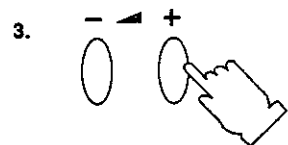
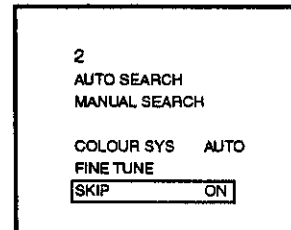

Press the Volume Up "+" or Down "-" button.

The displayed "ON" condition changes to "OFF".

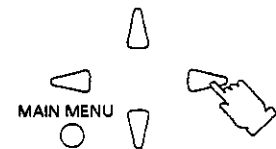
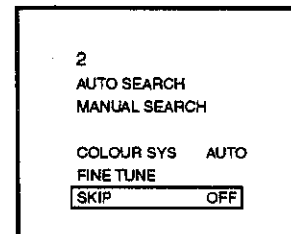

Press the Position Left or Right button.

Repeat step 2 and 3, if you wish to cancel the Skip function on any other programme number.

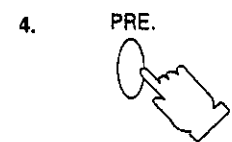

After the Skip Cancel operation is completed, press the "PRE" button once.

This returns the set to the normal viewing condition.

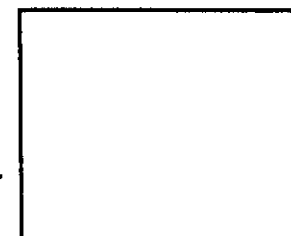

After the Skip Cancel Operation is completed, press the "MAIN MENU" button twice.

Tuning Procedure

Colour System Selection

Use this function if a clear picture with weak colour is obtained when a Broadcast or AV signal is received.

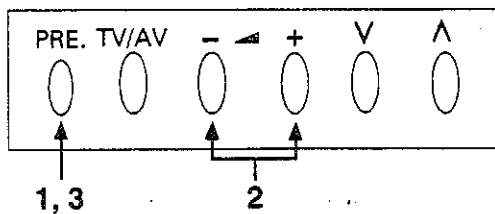

OR

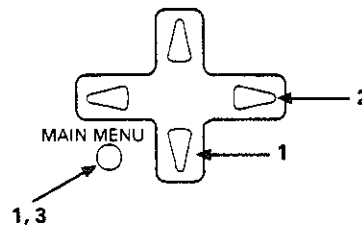

1. **PRE.** Press the "PRE." (PRESET) buttons 3 times.

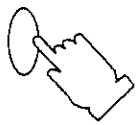

Colour System condition.

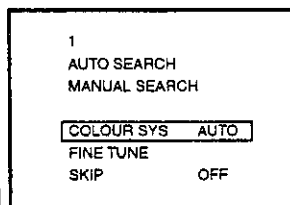

Press the "MAIN MENU" and "Position" buttons, until "COLOUR SYS" is selected.

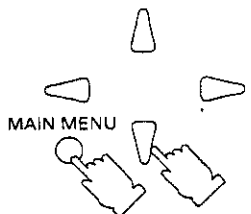

2. Press the Volume Up "+" or Down button, "-" repeatedly until the optimum image is produced.

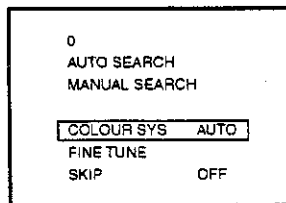
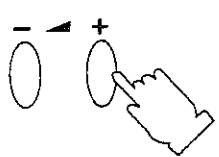

The Colour system will change as shown:

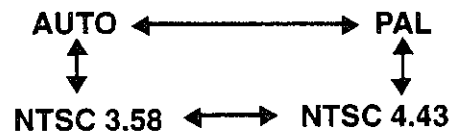

Press the Position Left or Right button repeatedly until the optimum image is obtained..

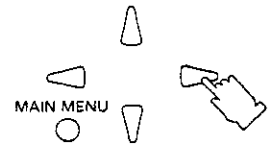

3. **PRE.** Press the "PRE" (PRESET) button 3 times.

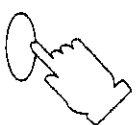

This returns the set to the normal viewing condition.

This selected Colour System is automatically memorized.

MAIN MENU Press the "MAIN MENU" button twice.





Advanced Remote Control Operation

Picture Menu Operation

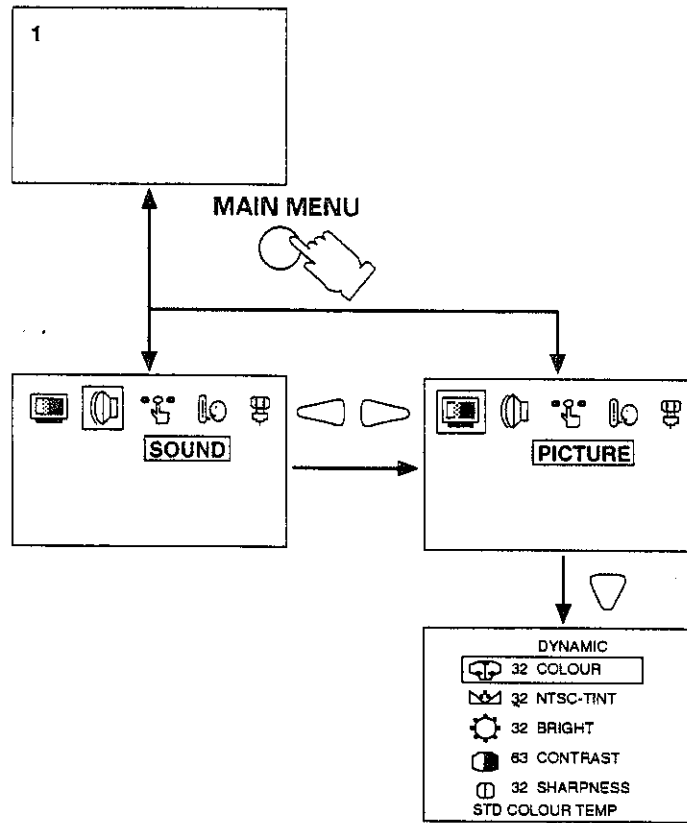
Method

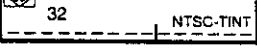
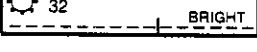
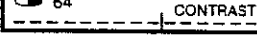

Picture Menu

Push	Item	Effect	Indicator
▽ △ Select	COLOUR	◀ ▶ Less More	
▽ △ Select	NTSC-TINT	◀ ▶ Greenish Reddish	
▽ △ Select	BRIGHT	◀ ▶ Darker Brighter	
▽ △ Select	CONTRAST	◀ ▶ Less More	
▽ △ Select	SHARPNESS	◀ ▶ Less More	
▽ △ Select	COLOUR TEMP	◀ ▶ STD ← → WARM	COLOUR TEMP

Helpful Hint

1. By pushing the Normal "N" button on the Remote control while the Picture menu is displayed, the setting of the selected function will be return to factory setting level.

Advanced Remote Control Operation

Sound Menu Operation

Method

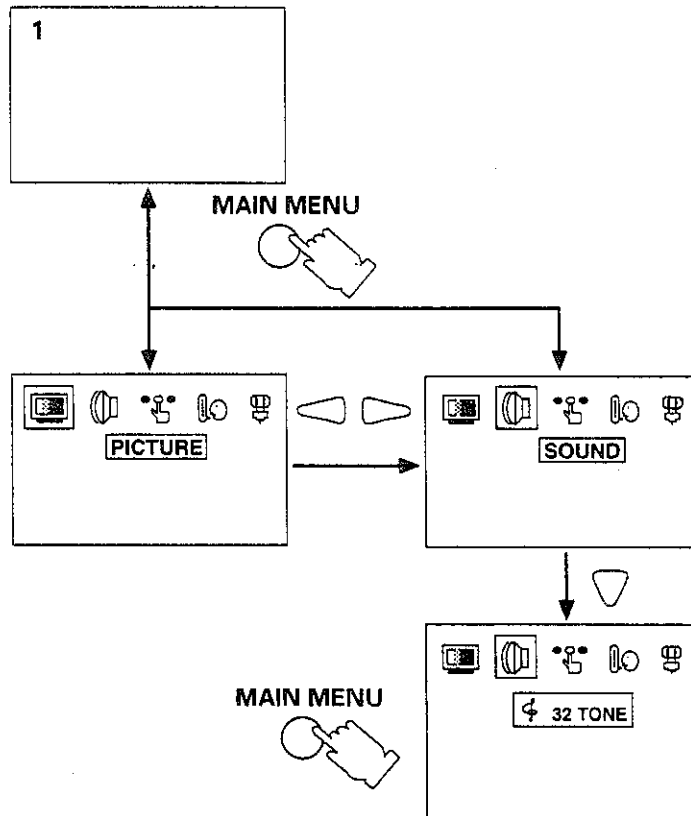

Sound Menu

Push	Item	Effect	Indicator
▽ △ Select	TONE	◀ ▶ Less More	⌘ 22 _____ TONE

Helpful Hint

1. By pushing the Normal "N" button on the Remote control while the Sound menu is displayed, the setting of the selected function will return to factory setting.

Advanced Remote Control Operation

FEATURES Menu Operation

Method

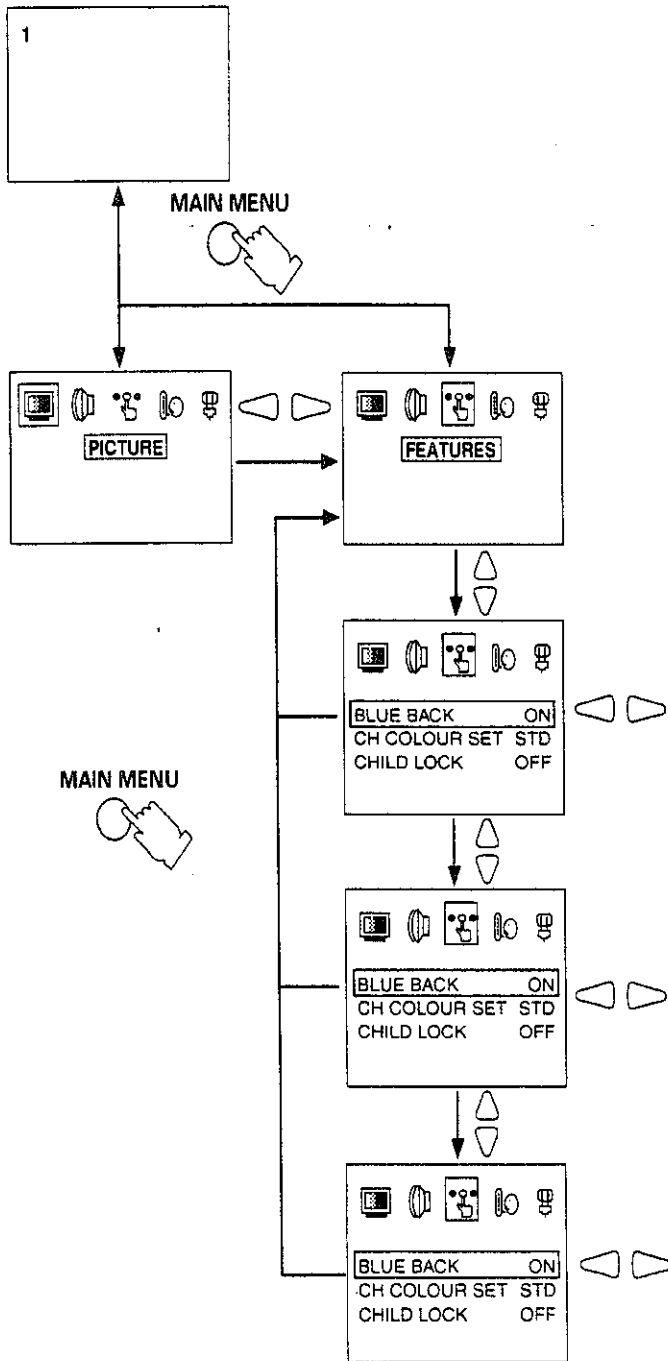

BLUE BACK Mode

When no picture signal is received, or the signal is weak, the screen reverts to a blue background colour and the sound is muted.

Disable this features to continue watching very weak signals.

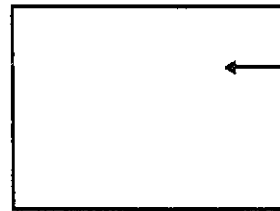

Blue background colour if no input picture signal or input signal is weak.

Note :

If BLUE BACK Mode is set on while a VCR signal is being viewed, selecting CUE or REWIEW may cause the screen to revert to the blue background colour. Disable this feature to view correctly.

CH (Channel) COLOUR SET mode.

Colour density varying between broadcast channels can be adjusted to three levels for each reception channel as follow:



CHILD LOCK mode.

To child lock any channel, press the position left or right button.

- 1) When channel is "LOCK", sound is muted and screen becomes blue colour.
- 2) If any the channels is CHILD LOCK, then preset key at any panel will not work. If preset key (Panel) is pressed, message "Child Lock ON" will appear.
- 3) Main power ON in child locked channel will display "CHILD LOCK ON" on screen to remind user that the Child lock is On and is in Child locked channel.
- 4) Each channel has its own memory for channels to be child locked.

Advanced Remote Control Operation

Language Menu Operation

Method

Language Menu

Press the "Position Up or Down" button. The on-screen language display will change as follows:

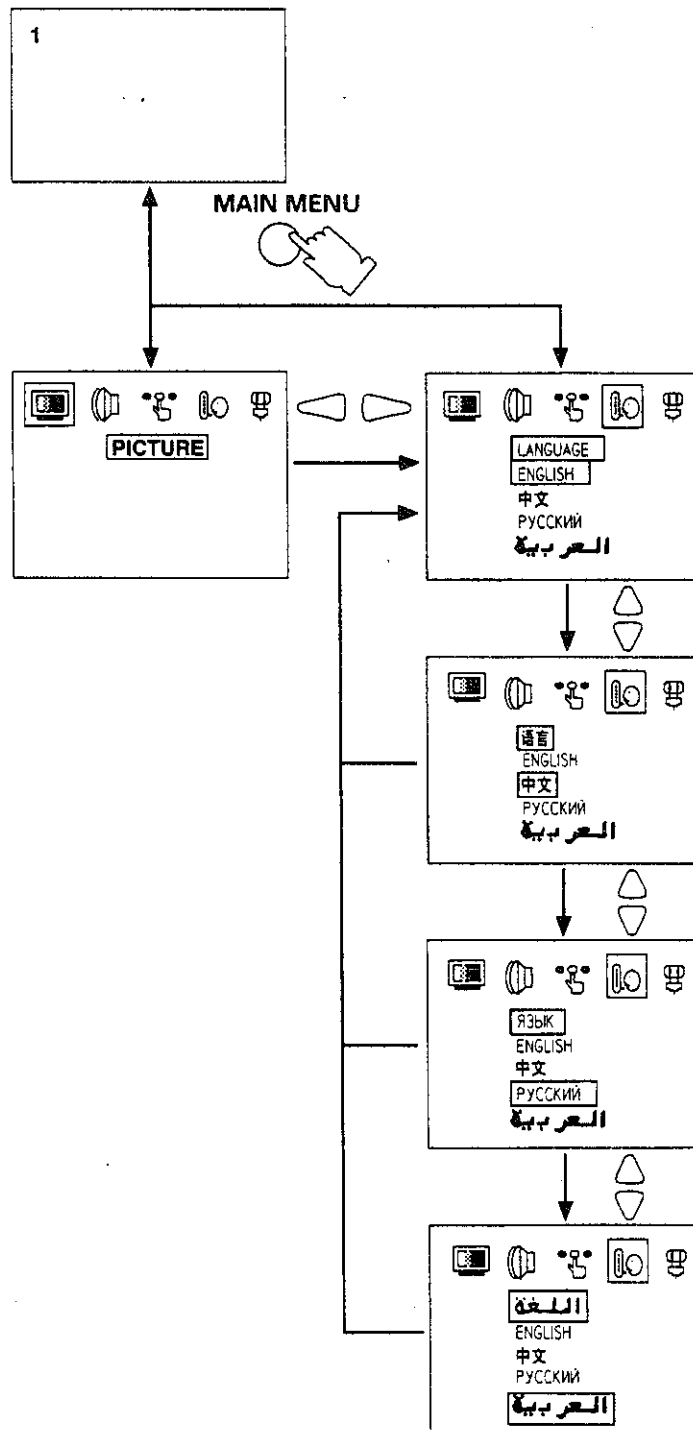

Antenna Connection

To obtain the best quality picture and sound, plug the connectors (300 Ohm Ribbon or 75 Ohm Coaxial Cable) to the antenna terminal on the rear of TV set.

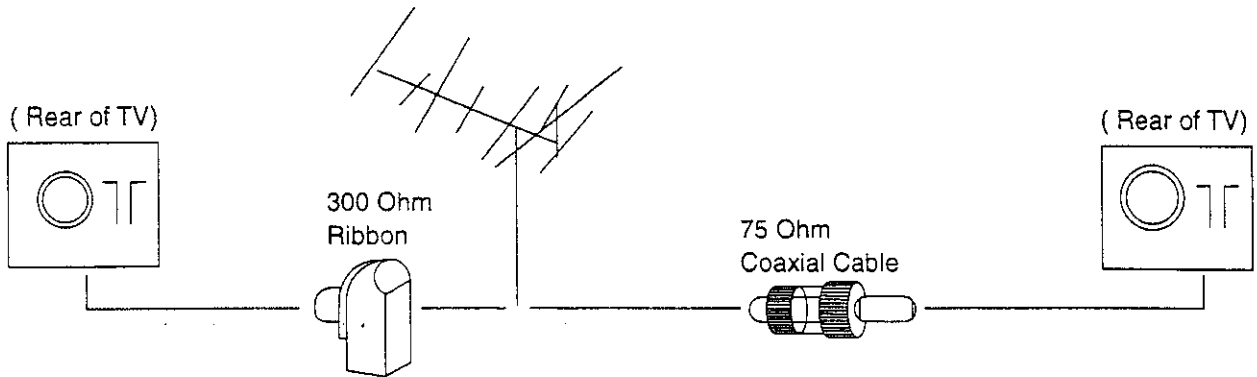

Connections (Audio Input and Video Input)

To watch the VCR picture :

Connect the VCR cable to the AUDIO INPUT and VIDEO INPUT terminals at the rear of TV.

Press the TV/AV selection button, set the VCR to the playback mode.

To watch or to return to the TV programme, press the TV/AV selection button again.

Note:

If both AV terminal are connected at the same time, only front AV input terminal can operate.

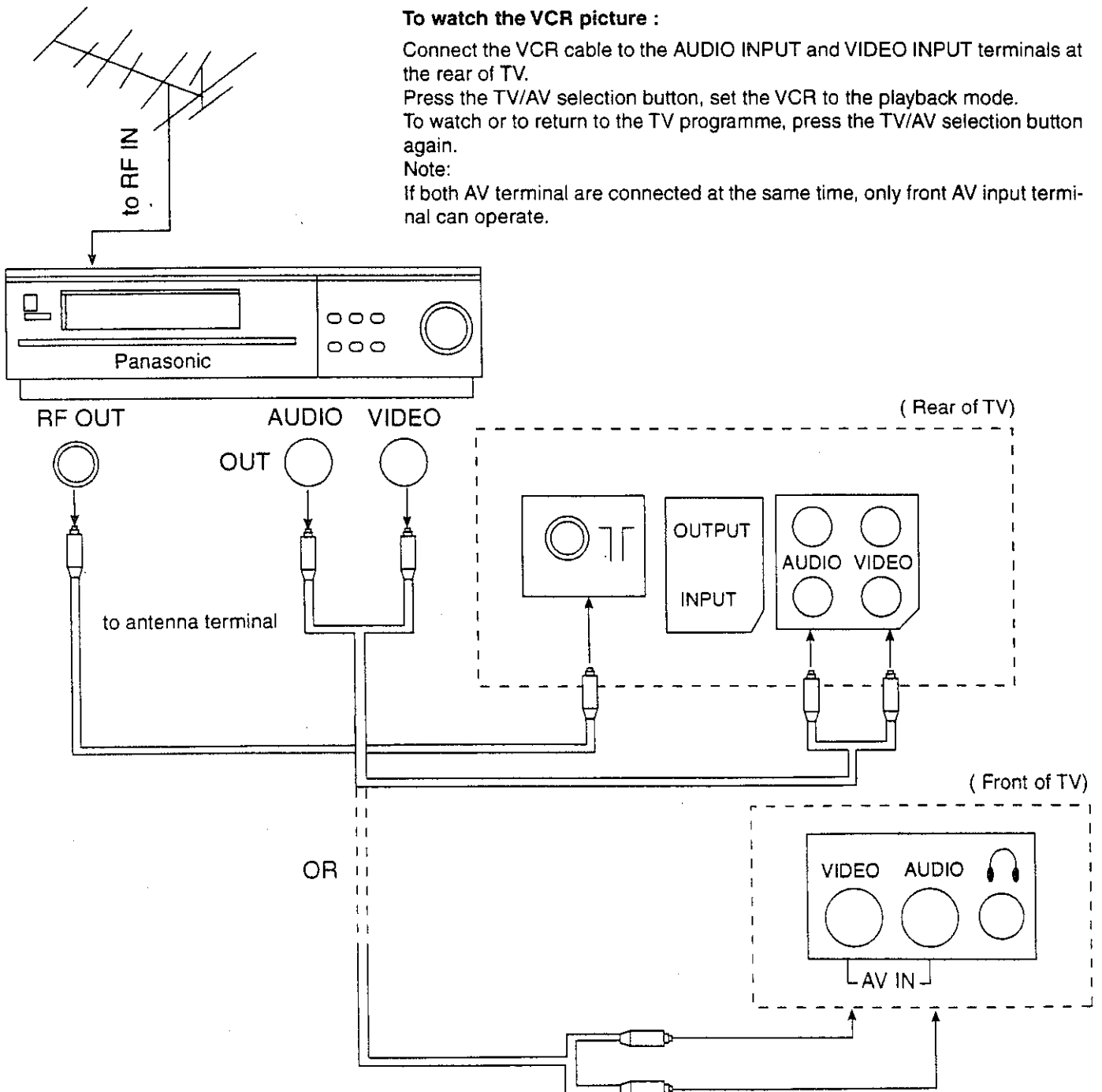





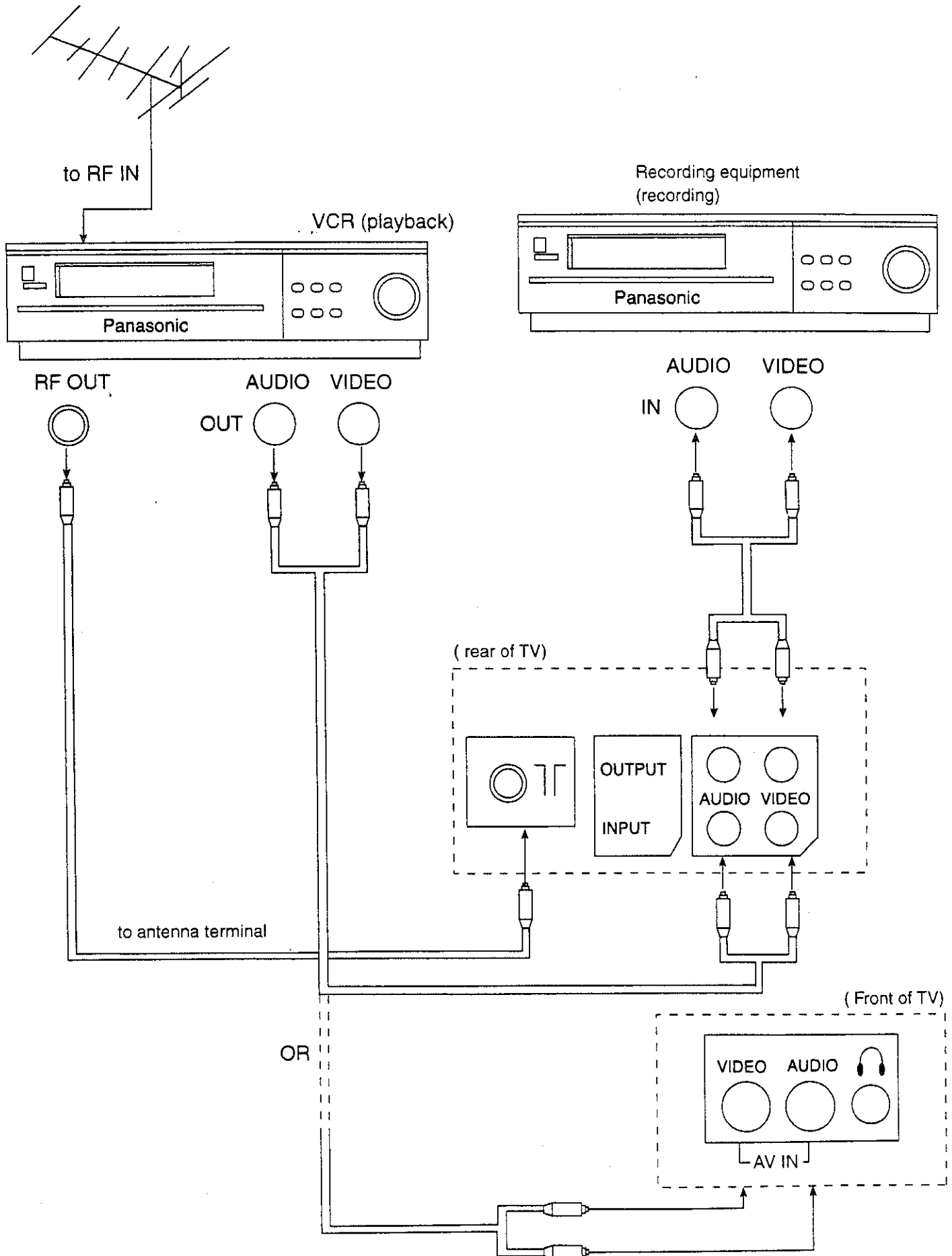













Recording

Follow the connection shown below when you want to copy a programme from another tape (VCR).

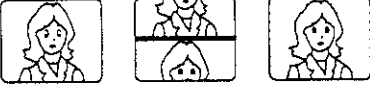

Troubleshooting

Before calling for service, determine the symptoms and make a few simple checks as shown below.

Symptoms		Checks
Picture	Sound	
 Snowy Picture	 Noisy Sound	Aerial Location, direction Connection
 Multiple Image	 Normal Sound	Aerial Location, direction Connection
 Interference	 Noisy Sound	Electrical Appliances Cars / Motorcycles Fluorescent Lamps
 Normal Picture	 No Sound	Volume (Check whether the mute function has been activated on the Remote Control.)
 No Picture	 No Sound	Not plugged into AC outlet Not switched on Contrast and Brightness / Volume Setting (Check by pushing the Power Switch or Stand-by Button on the Remote Control.)
 No Colour	 Normal Sound	Colour Control
 Scrambled	 Weak Sound	Re-tune Channels
 Colour Patches	 Normal Sound	Magnetic interference from unshielded equipment. Receiver moved while "ON"
 No Colour Rolling Picture H-Line	 Noisy Sound	System Button

Specifications

Power Source : AC SINGLE 220 - 240 V, 50Hz

Power Consumption : 98 W

Tuning System : Voltage synthesizer, Auto search tuning 100 position

Picture Tube : 51 cm, measured diagonally, 90° deflection

Audio Output : 2 x 2.5W

Remote Control Transmitter : EUR 501380

Battery : R6 (AA) x 2

Dimension (W x D x H) : 630 x 481 x 472 mm

Weight (Net): 21 Kg

Receiving Systems : 4 SYSTEM
PAL B, G
NTSC M
NTSC (VTR playback only)
PAL 60Hz

Receiving Channels :

VHF BAND
1 – 11 PAL B, G
UHF BAND
21 – 69 PAL B, G
CATV
S1 – S41 (HYPER)

Note :

Design and Specifications are subject to change without notice.

Customer's Record:

The serial number of this product can be found on its rear cover. You should note this serial number in the space provided below and retain this book plus your purchase receipt as a permanent record of your purchase to aid in identification in the event of theft or loss, and for warranty Service-purposes.

Model Number : _____

Serial Number : _____

Matsushita Electric Industrial Co., Ltd

Central P.O. Box 288, Osaka 530-91, Japan