

OWNER'S MANUAL

Palsonic

51CM CORDLESS REMOTE COLOUR TELEVISION
MODEL: 5159G



Type Tested
Electrical
Safety
AS/NZS 3250 Lic 4164
Standards Australia
APP No: N15959

PALSONIC CORPORATION PTY LTD
1 JOYNTON AVENUE
WATERLOO NSW 2017 AUSTRALIA
TEL:(02)9313 7111
FAX:(02)9313 7555

**PALSONIC CUSTOMER SERVICE
TELEPHONE
AUSTRALIA:1300 657 888**

Congratulations on your purchase of this Palsonic colour television receiver.

We recommend that you thoroughly read this manual before use to fully enjoy the many functions and excellent effects of this receiver.

Retain this manual in an easily accessible location for future reference.

* Screen displays and illustrations in this manual may differ from the actual ones for better visibility.

Contents

INTRODUCTION—————

Features1

NOTES FOR OPERATION—————

Cautions for safety.....2

INSTALLATION—————

Antenna connection.....3

Battery installation.....3

APPEARANCE—————

Front view.....4

Back view.....4

Remote controller.....5

OPERATION—————

Turning the Power On/Off.....6

Menu Operation.....6

Tuning in.....7

To preset channels (ASM).....7

To preset channels (SEARCH).....7

To skip unnecessary position numbers.....9

MFT (Manual Fine Tuning).....9

AFT (Automatic Frequency Tuning).....10

The setting of colour and sound system..10

Channel selection.....11

Convenient Picture and Sound Control....12

CLOCK setting.....13

SYSTEM setting.....14

Playing Games.....15

Sleep timer.....16

Other functions.....17

CALENDAR function.....17

CHILD LOCK setting.....17

CHANNEL SWAP.....18

Super receiving function.....18

Program Scan.....18

CONNECTING OTHER EQUIPMENT———

External Equipment Connections.....19

Video playback.....19

Recording TV program.....19

OTHERS—————

Troubleshooting.....20

Specifications.....21

INTRODUCTION _____

Features

- **Hyperband**
- **English/Chinese on-screen menu display**
- **256 preset channels**
- **Intellectualized I²C-bus control**
- **Full function remote control**
- **SLEEP timer, ON Timer, OFF Timer**
- **Non-signal blue background display and AUTO-POWER-OFF function**
- **Games, built-in 500 years' calender**
- **Child Lock function, channel swap**
- **Program scan function**
- **Five picture modes' setting**
- **AUDIO/VIDEO input & output terminals**
- **Advanced digital picture improvement circuit**

NOTES FOR OPERATION

- * Do not let the TV set be in stand-by condition for a long period of time. When it is not in use, please turn off the power supply and remove the power plug. When it is to be left unattended for a prolonged period of time, it is recommended to disconnect the connection to the outdoor aerial, to avoid thunder strike.
- * Please follow cautions for safety in the TV set instructions, and all warnings and descriptions denoted on the TV set.

Cautions for safety

Note: This TV set can be operated on an AC power of 240V, 50Hz. You should not use power supply of the other type.

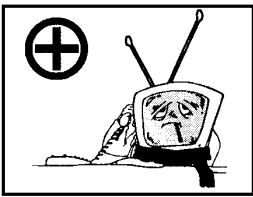

When an unusual situation occurs, turn off the power switch at once and remove the plug from the wall outlet. Contact a qualified service department in your local area.

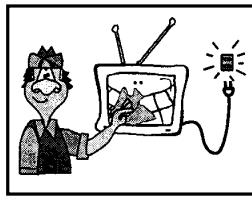

In order to wipe dust off the picture tube or off the cabinet, you should remove the power plug from the wall outlet first. You can wipe lightly with a piece of dry, clean, soft cloth.

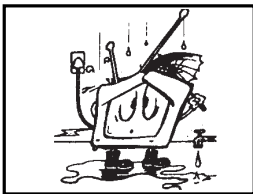

Do not expose the TV set to rain or excessive moisture, to prevent fire disaster or electric shock. Avoid using the set in very warm or damp places. Never use it in a bathroom.

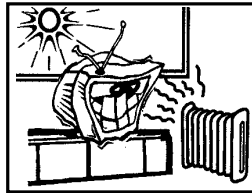

The TV set should be placed on an adequate place without exposing it to direct sunlight and other sources of heat to prevent the deformation of the cabinet or damage to components.

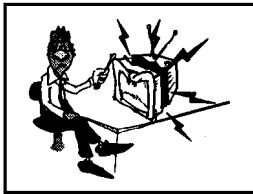

There exists High Voltage in this TV set. Do not remove the cover to avoid danger.

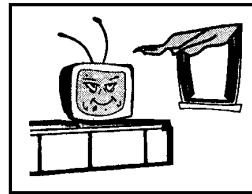

Do not cover the Ventilating holes in the cabinet. Keep a space of more than 5cm from the walls to the TV set, to guarantee the good ventilation.

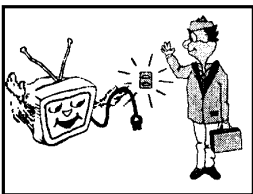

When the TV set is to be left unattended, please turn off the power switch and remove the plug from the wall outlet.

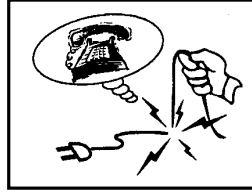

When the power cord or the plug is damaged, please contact a qualified service department to get service.

Installation

Antenna Connection

To ensure a bright-coloured and clear picture, you should use an outdoor aerial or CATV cable. If the signals are strong enough, you may use an indoor aerial.

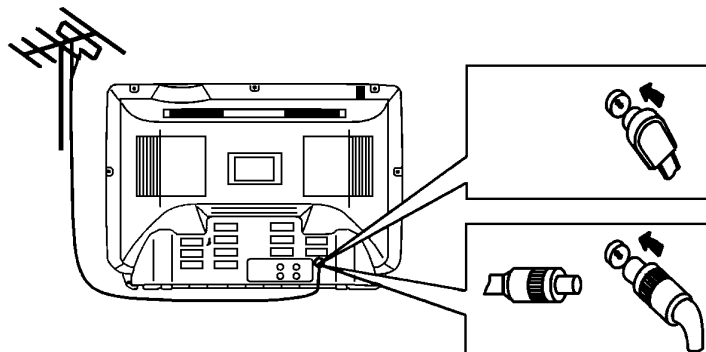

Note: In case of using the Twin-lead aerial feeder (300Ω) for UHF/VHF aerial, use a 300-75 ohm adaptor (not supplied)

When using the coaxial cable (not supplied) (75Ω) for UHF/VHF aerial, connect the plug into the 75 ohm aerial socket directly.

Note:

When you connect the outdoor aerial cable to the aerial terminal on the TV set, please turn off the power switch on the TV while connecting the antenna lead.

In thunder and lightning weather, please disconnect the outdoor aerial to avoid thunder/lightning strike.

Battery installation

(1) Remove the back battery cover.

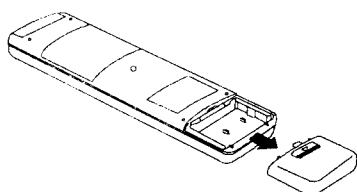

(2) Insert two size AAA batteries according to the polarity indication inside the remote controller.

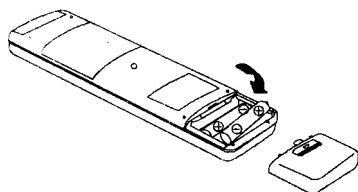

Effective range of the remote control operation

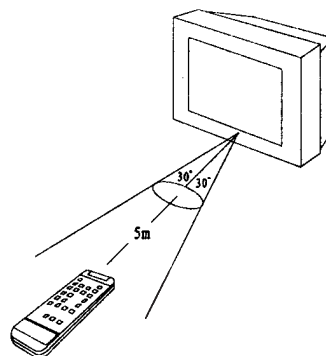

Notes:

1. When the remote controller is not used for an extended period of time or the batteries are worn out, please remove the batteries in time to avoid battery leakage.
2. Avoid moisture and mechanical shock to the remote controller.
3. Do not drop, dampen or disassemble the remote controller.

Front view

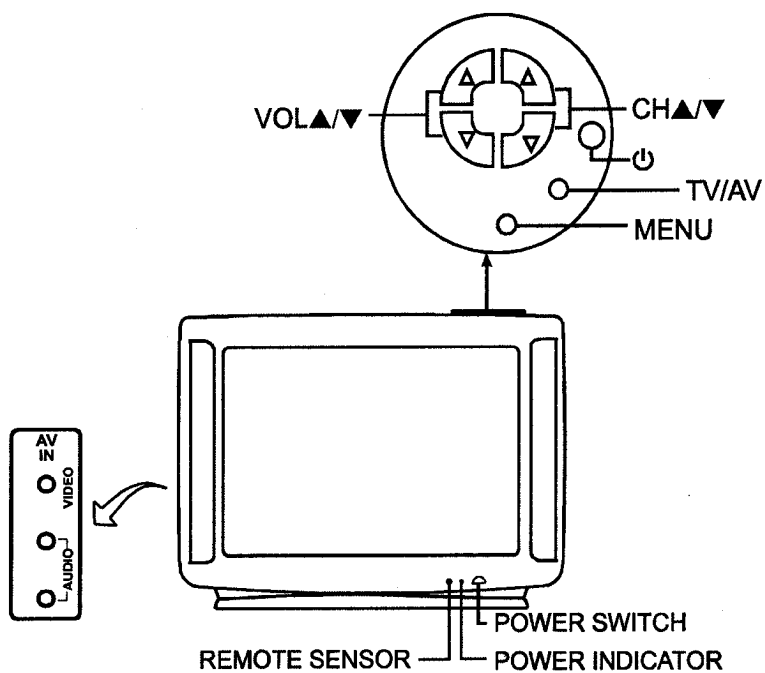

Note: Functions of ⏻, MENU, TV/AV, VOL▲/▼, CH▲/▼ are also provided to the remote controller.

Back View

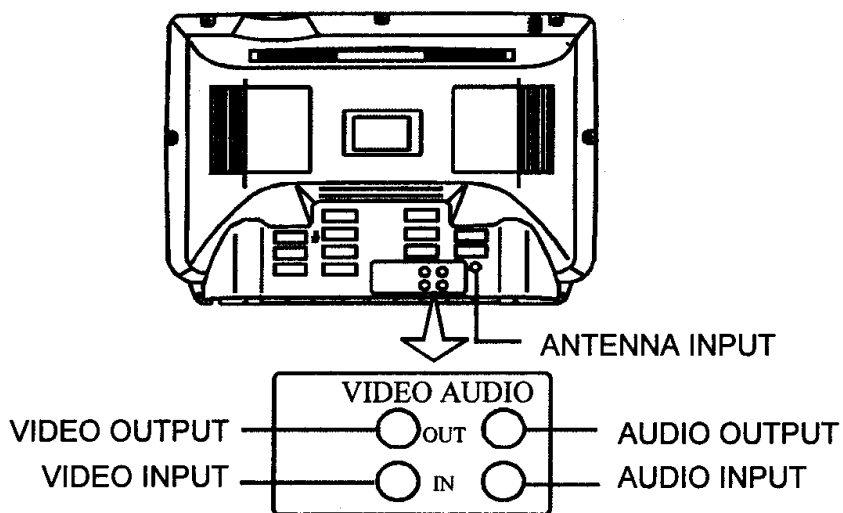

Remote Controller

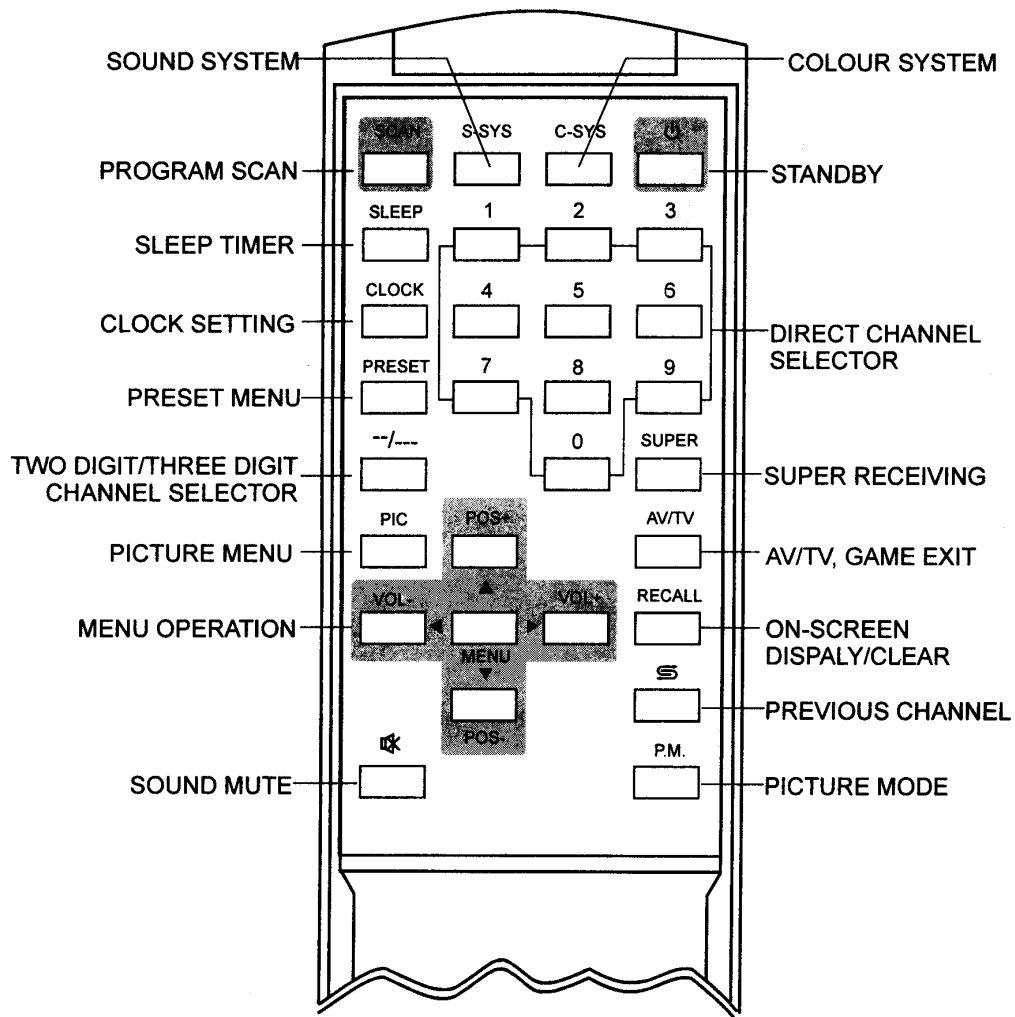



OPERATION

Turning the Power On/Off & Menu Operation

- The following describes how to turn the TV on/off using the TV's main switch and the remote controller.



To turn the power on/off

1. Press the **POWER** switch, the red power indicator lights up.

2.  If no picture appears on the screen, press the  button on the set or on the remote controller to turn the set on and the yellow indicator light up.

*Note: If there are no input signals to the TV when the TV set is on, a blue background will appear on the screen. After 15 minutes if there are still no signals to the TV, it will enter into standby mode automatically.

3. Press the **POWER** switch to turn off the set completely.

4.  If you want to turn off the TV temporarily, press the  button on the remote controller to switch the set to standby mode

Special indication:

Last-Mode-Memory: after turning off the power, the last TV mode, picture and sound setting mode and preset channels all are memorized. Therefore, next time you turn on the TV, the TV will work in the previous setting mode.

- If you directly pressed the main power switch on the TV to turn it off, you must press the main power switch to turn on the TV.
- If you pressed the main power switch to turn off the TV when in standby mode, press the main power switch and then operate from the remote controller to turn the TV on.

Auto-Power-Off: there are two kinds of Auto-Power-Off function:

1. If a vacant channel is tuned or TV broadcast for a day is finished, the TV will automatically turn off after about 10 minutes.
2. SLEEP-timer function.
3. OFF timer function.

Menu Operation

Press **MENU** button to enter into cartoon graphics menu page, press **MENU** button or **POS+/-** button repeatedly can select different graphics. The selected graphics is highlighted and the menu name will appear above the graphics (each graphics represents a menu) . Press **VOL+/-** button to enter into the sub-menu. To call, press **RECALL** button.

OPERATION

Tuning in

- There are two ways to preset channels: to preset channels automatically and to preset channels manually. Below we will describe how to preset the channels by making use of the menu.

To preset channels (ASM)

Use the ASM (Automatic Search Memory) function to preset all the active channels in your local area automatically.

To enter into the PRESET menu





Press the **PRESET** button to display **PRESET** the menu on the screen. (Or you can press the **MENU** button repeatedly to select and highlight **PRESET** icon, then press the **VOL+** button to enter into the **PRESET** menu.)

PRESET	
→ POS	22
SKIP	OFF
BAND	UHF
FINE	
AFT	ON
SEARCH	
ASM	
S-RCV	OFF

Note: If there is any channel which is in **CHILD LOCK ON** mode, the **PRESET** menu can not be entered. How to enter into the **PRESET** menu to preset channels, please refer to page 17.



In **AV** mode, press the **MENU** button, on the interface there are three icons in red background colour (**PRESET**, **SWAP**, **LOCK**), which indicates these items can not be used in **AV** mode.

ASM (Automatic Search Memory)

- 



Press the **POS+/-** button to select and highlight **ASM**

PRESET	
POS	22
SKIP	OFF
BAND	UHF
FINE	
AFT	ON
SEARCH	
→ ASM	
S-RCV	OFF

- 

Press the **VOL+/-** button to start the **ASM**. All active channels will be preset and stored into the memory automatically. After presetting, the TV will return to the first channel program.

PRESET	
POS	22
SKIP	ON
BAND	UHF
FINE	
AFT	OFF
SEARCH	
→ ASM	
S-RCV	OFF

- 

During the process of **ASM**, pressing the **PRESET** button or **MENU** button on the remote controller will stop the process.

	0
--	---

Note: Before **ASM** (Auto search), please set the current channel's colour system to **AUTO** and sound system to local area's sound system (refer to page 10), thus after **ASM**, all programs' colour and sound system have been set correctly. Otherwise you should reset every program's colour and sound system according to page 10.

OPERATION

Tuning in (continued)

- Use the **SEARCH** function if desired channels can not be preset with the **ASM** or if you would like to preset channels to specific position numbers one by one.
- It is convenient to set the channel numbers to the same position numbers using **SEARCH** and **SKIP** functions.

To preset channels (SEARCH)

SEARCH

If **ASM** can not preset the desired channels, or you want to preset the desired channels one by one with the preferred channel numbers, please make use of **SEARCH**.

1.

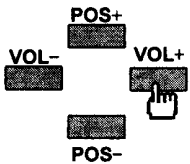

Enter into **PRESET** menu, press the **POS+/-** button to select and highlight **POS**. Press the **VOL+/-** button to select a desired position number (from 0-255).
 Note: you can also press 0-9 button to select a one-digit position number.
 Press --/-- button and number buttons to select a two-digit or three-digit position number.

PRESET	
→ POS	4
SKIP	ON
BAND	V-L
FINE	
AFT	OFF
SEARCH	
ASM	
S-RCV	OFF

2.

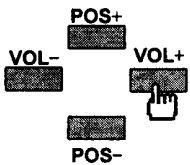

Press the **POS+/-** button to select **SEARCH**. Press the **VOL+** button to search channels from current channel to higher channel. Press the **VOL-** button to search channels from current channel to lower channel. When a channel is located, the searching stops, this channel is then memorized with the preset position number.

PRESET	
POS	4
SKIP	ON
BAND	V-L
FINE	
AFT	OFF
→ SEARCH	
ASM	
S-RCV	OFF

Note: you can also make use of **BAND** selection to quicken the searching process in your desired band. Press the **POS+/-** button to select **BAND**, pressing the **VOL+/-** button moves the band to the next one in the sequence below.

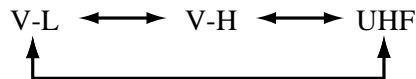

PRESET	
POS	20
SKIP	OFF
→ BAND	V-H
FINE	
AFT	OFF
SEARCH	
ASM	
S-RCV	OFF

3. When you want to store another channel at another position, repeat steps 1 & 2 above.

Note: After **SEARCH**, to exit the **PRESET** menu, press the **RECALL** button, or press **PRESET** button or **MENU** button repeatedly until **OSD** disappears.

OPERATION

Tuning in (continued)

To skip unnecessary position numbers and MFT (Manual Fine Tuning)

To skip a position number

After presetting the channel you can skip unnecessary position numbers so that only the channels you want to watch are selected with **POS+/-** button.

1. Enter into the **PRESET** menu, press the **POS+/-** button to select **POS.**, then select the unwanted program number with the **VOL+/-** button.

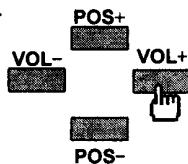

PRESET	
→ POS	24
SKIP	OFF
BAND	UHF
FINE	
AFT	ON
SEARCH	
ASM	
S-RCV	OFF

2. Press the **POS+/-** button to select "SKIP". Press the **VOL+/-** button to select "SKIP ON". Thus, after exiting the menu, the position number will then be skipped when you select programs with the **POS+/-** button.

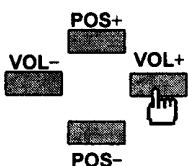

If you want to skip other unwanted programs, repeat step 1 above to change the program number.

PRESET	
POS	24
→ SKIP	ON
BAND	UHF
FINE	
AFT	ON
SEARCH	
ASM	
S-RCV	OFF

(or OFF)

Note: you can select the skipped channel by pressing the direct channel select buttons, and the position number displayed on the screen is in red.

To restore skip a position number

Enter into the **PRESET** menu, Select the position number you want to restore. Press the **POS+/-** button to select "SKIP". Press the **VOL+/-** button to select "SKIP OFF".

MFT (Manual Fine Tuning)

When picture and sound's effect of a channel is poor (for example: one or two CATV channel's picture and sound are not standard), you can correct them by making use of Manual Fine Tuning (FINE).

1. Enter into **PRESET** menu, select the program number you want to fine-tune.



PRESET	
→ POS	25
SKIP	OFF
BAND	UHF
FINE	
AFT	ON
SEARCH	
ASM	
S-RCV	OFF

2. Press the **POS+/-** button to select **FINE**, then press and hold the **VOL+** or **VOL-** button, the channel begins fine tuning until the optimum picture and sound is achieved. (Press **VOL+** button to fine-tune upward, while **VOL-** button to fine-tune downward. The AFT function will be set to OFF mode automatically)

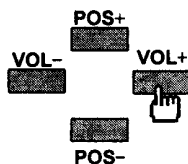

PRESET	
POS	25
SKIP	OFF
BAND	UHF
→ FINE	
AFT	ON
SEARCH	
ASM	
S-RCV	OFF

Note: if some channel's colour or sound is abnormal, it may be that the setting of the colour or the sound system is wrong, please do adjustment according to *The setting of colour and sound system* (on page 10) to set the proper colour and sound system.

3. To exit the menu, press the **RECALL** button.

OPERATION

Tuning in (continued)

AFT (Automatic Frequency Tuning)

If picture and sound's effect of the channel is instead poor by making use of FINE, you can correct them by making use of AFT.

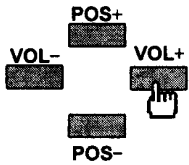

Enter into the **PRESET** menu, press **POS+/-** button to select **AFT**, press **VOL+/-** button to select AFT ON.

Note: If the program is in AFT ON, the position number displayed on the screen will be in green.

PRESET	
POS	22
SKIP	OFF
BAND	UHF
FINE	
➔ AFT	OFF
SEARCH	
ASM	
S-RCV	OFF

The setting of colour and sound system

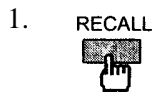

Press the **RECALL** button, the colour and sound system will be displayed on the screen.

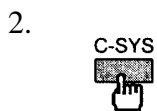
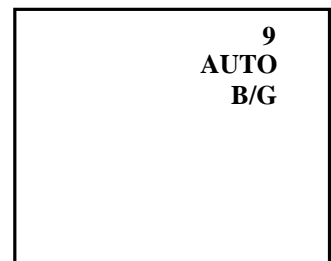

If the colour is abnormal, press the **C-SYS** button to select proper colour system. Every time you press the **C-SYS** button, the colour system will change in the sequence below.

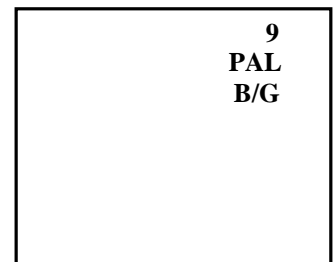

If the sound is abnormal, press the **S-SYS** button to select proper sound system. Every time you press the **S-SYS** button, the sound system will change in the sequence below.

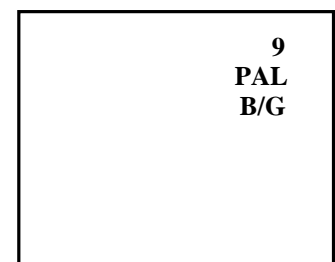
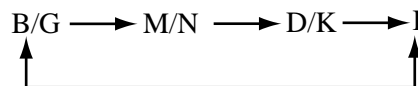

Now you can watch the broadcasting TV program on the preset channels.

Note: You can also make use of **SYSTEM** menu to set the colour and sound system. (Refer to **SYSTEM SETTING** on page 14.)

OPERATION

Channel selection

- You can watch TV programmes being broadcast on the preset channels.

To watch a TV programme

You can select your desired TV program by one of the following methods.

Using the direct select buttons (0~9) and --/--button

- To select a one-digit position number (0-9)**
Press the 0~9 button directly.
- To select a two-digit position number (10~99)**
Press --/-- button to display -- on the screen, then press the channel number.
- To select a three-digit position number (100-255)**
Press --/-- button to display --- on the screen, then press the channel number.

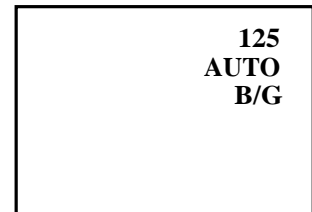
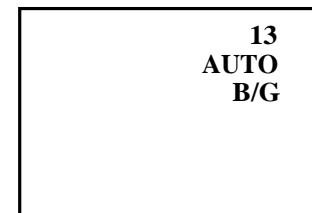
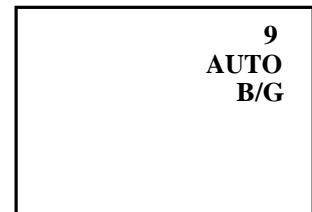

Using the POS+/- buttons

 Press **POS-** to select lower position numbers; **POS+** to select higher ones.

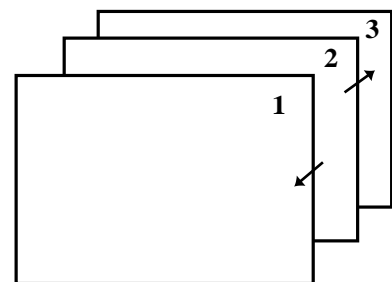

Using the PREVIOUS channel button (S)



Press the **S** button on the remote controller can swap the current viewed channel with the previous one. For example, the channel you previously watched is 11, the present channel is 2, press the **S** button, it will return to channel 11, press the **S** button again it will return to channel 2.

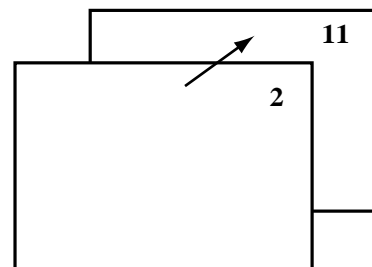

OPERATION

Convenient Picture and Sound Controls

Selectable picture

To select the picture mode



You can select the picture quality instantly among four preset modes and one user-set mode.
Press the **P.M** button to select the desired picture quality.

SOFT, STANDARD, VIVID, LIGHT and **PERSONAL** (user-set) can be selected cyclically.

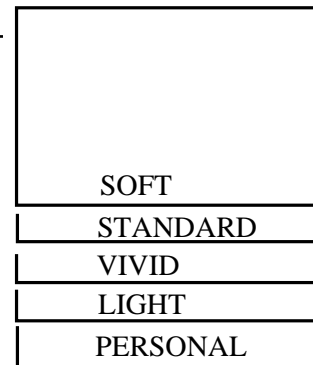

To set the desired picture quality to the MEMORY position

1.

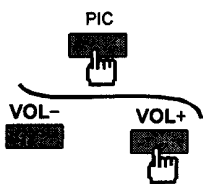

Press the **PIC** button repeatedly to select the desired adjusting item.
Press the **VOL+/-** button to adjust the level.

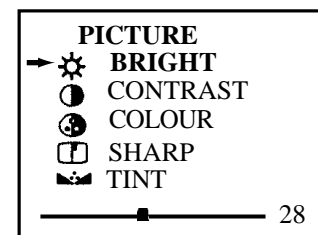

Item	Pressing (PERSONAL)		SOFT	STANDARD	VIVID	LIGHT
	VOL-	VOL+				
COLOUR	paler	deeper	38	38	50	50
BRIGHTNESS	darker	lighter	45	50	48	58
CONTRAST	weaker	stronger	28	50	63	63
SHARPNESS	softer	sharper	16	32	34	34
*TINT	purplish	greenish	00	00	00	00

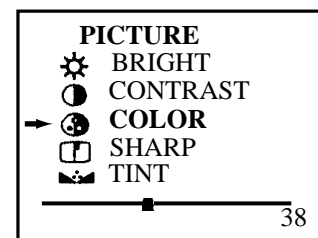

* TINT is for NTSC system only.

The adjusted level is stored in the MEMORY position.

Adjusting the volume and muting the sound

To adjust the sound volume



Adjust the sound volume with the **VOL+/-** buttons.
Press the **VOL-** button to decrease the sound.
Press the **VOL+** button to increase the sound.



To mute the sound

The muting function is convenient when you need to pay attention to surrounding sounds, answer a phone call, receive a visitor, etc.



Press the **MUTE** button to mute the sound.
To restore the sound, press the **MUTE** button again or **VOL+/-** buttons.

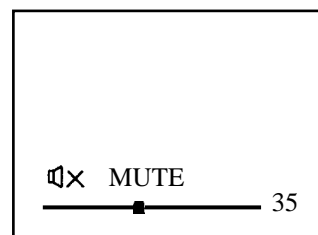

OPERATION

CLOCK SETTING

CLOCK menu

Press the **CLOCK** button to display the **CLOCK** menu. (Or press the **MENU** button repeatedly to select and highlight **CLOCK** icon, and press **VOL+/-** button to enter into the **CLOCK** menu.)

CLOCK	
→ TIME	--:--
OFF-TIME	--:--
ON-TIME	--:--
POS	-

TIME setting

Making use of this function can set the current time for the TV.

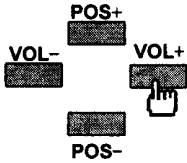

Press the **POS+/-** button to select and highlight **TIME**. Press the **VOL-** button to set the hour (0~23). Press the **VOL+** button to set the minute (00~59).

CLOCK	
→ TIME	18:23
OFF-TIME	--:--
ON-TIME	--:--
POS	-

OFF-TIME setting

Making use of this function can automatically turn off the TV at a preset time, and bring the set to standby mode.

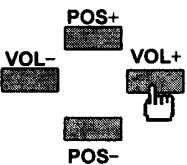

Press the **POS+/-** button to select **OFF-TIME**. Press the **VOL-** button to set the hour (0~23) press the **VOL+** button to set the minute (00~59). Once the preset time has elapsed, the TV will automatically go into standby mode.

CLOCK	
TIME	18:24
→ OFF-TIME	22:50
ON-TIME	--:--
POS	-

ON-TIME setting.

Making use of this function can automatically turn on the TV at a preset time to a preset channel.

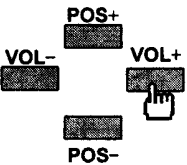

Press the **POS+/-** button to select **ON-TIME**. Press the **VOL-** button to set the hour (0~23), press the **VOL+** button to set the minute (00~59). Press the **POS+/-** button to select **POS.**, press the **VOL+/-** button to set the TV ON position number. (Or you can press 0-9, --/-- button to set the position number).

Press the **⏻** button to switch the TV to standby mode. At the preset time, the TV will turn on automatically to the preset channel.

CLOCK	
TIME	18:25
OFF-TIME	22:50
→ ON-TIME	19:00
POS	-

CLOCK	
TIME	18:24
OFF-TIME	22:50
ON-TIME	--:--
→ POS	10

Note:

Once the function of ON/OFF TIMER has been fulfilled, next when you want to use the function once more, you should set them again.

OPERATION

System setting

SYSTEM menu

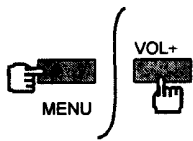

Press the **MENU** button repeatedly to select and highlight the **SYSTEM** icon. Press the **VOL+** button to enter into the menu of **SYSTEM**.

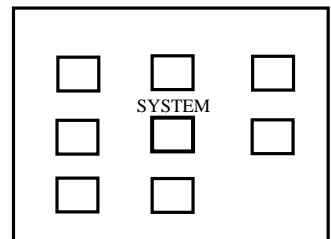

To select the language for the OSD (on-screen display)

Making use of this function can switch the language for the OSD to either English or Chinese.

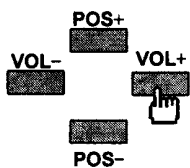

To switch the OSD language from English to Chinese, press **POS+/-** button to select **CHINESE (中文)**, press **VOL+** button, the screen menu is automatically displayed in Chinese.

To switch the OSD language from Chinese to English, press **POS+/-** button to select **英文 (ENGLISH)** press **VOL+** button, the screen menu is automatically displayed in English.

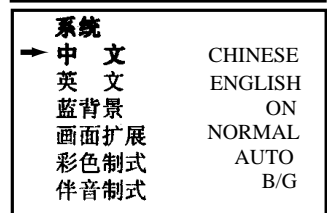
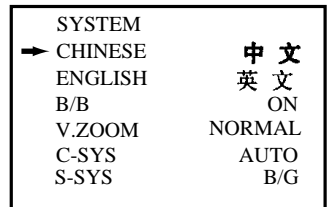

B/B (blue background) setting

With the B/B (blue background) function **ON**, the TV will automatically turn blue when no signal is being received.

In **SYSTEM** menu, press the **POS+/-** button to select **B/B**. Press the **VOL+/-** button to change the B/B (blue background) setting **ON** or **OFF**.

To exit the menu, press the **MENU** button repeatedly or press **RECALL** button.

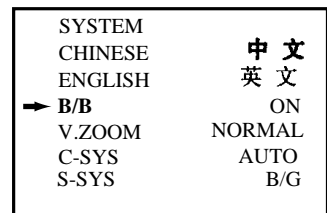

V.ZOOM setting

Making use of this function can change the screen's vertical size. Press **POS+/-** button to select **V.ZOOM** press **VOL+/-** button, **LEVEL -2, LEVEL -1, NORMAL, LEVEL 1, LEVEL 2** can be selected. You can select one of them according to actual need, for example, to view wide screen movie VCD.

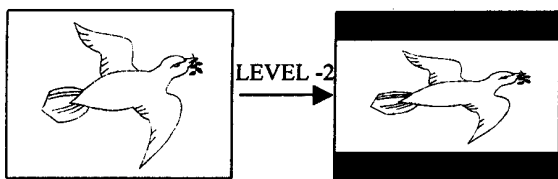
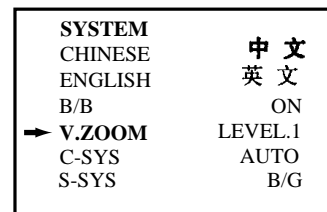

FIG. 1

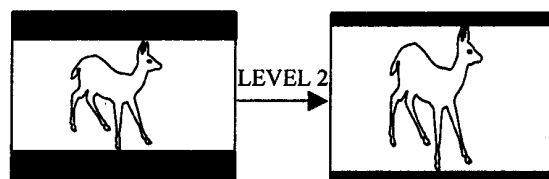
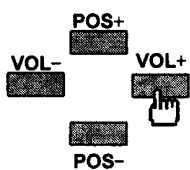

FIG. 2

Colour/sound system selection



In **SYSTEM** menu, press the **POS+/-** button to select **C-SYS** (or **S-SYS**) item.

Press the **VOL+/-** button to select proper colour (or sound) system.

To exit the menu, press the **MENU** button repeatedly or press **RECALL** button.

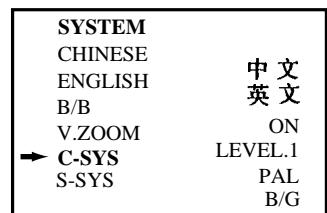

OPERATION

Playing Games

In this TV set there are two built-in games: *Falling Cube* and *Millennium Alien*. Below we will describe how to make use of them.

To enter into Game



Press **MENU** button to select and highlight **GAME** icon. Press **VOL+/-** button to enter into **GAME SELECT** menu.

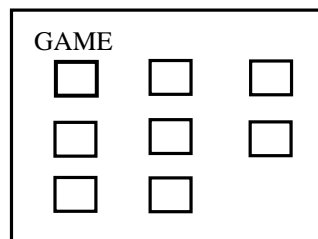

To select Game

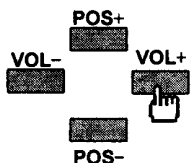

In **GAME SELECT** menu, press **POS+/-** button to select one of the games, press **VOL+/-** button to enter into the game.

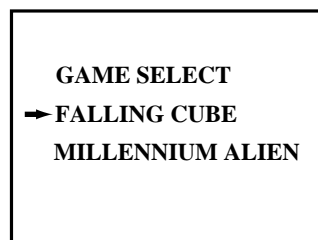

Making use of FALLING CUBE

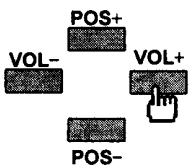

Enter into **FALLING CUBE**. On the screen, there are falling cubes, pressing **VOL+** button can move the cube rightward, pressing **VOL-** button move the cube leftward, pressing **POS-** button can let the cube falling quickly while pressing **MENU** button can rotate the cube.

When at the screen's left playing area one row has been filled with the cubes, the row will flash and disappear, and your score will gain one point. If two rows disappear at the same time, your score will gain three points. If three rows disappear at the same time, your score will gain seven points.

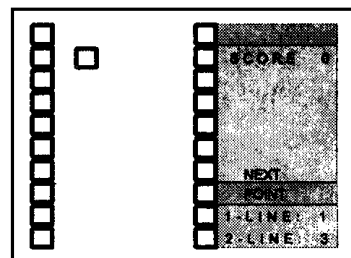

The right window provides hints about next cube's shape, you can arrange current cube's position and angle in advance.

You should try your best to improve your score. If you make mistakes and let the cubes pile too high, it will become more difficult to improve your score. When the cubes reach to top, the screen will display **GAME OVER**, and the game is finished.

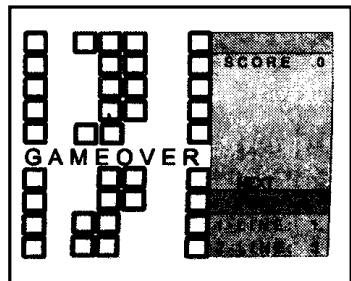

To exit the game playing (during the playing or when in gameover), press **AV/TV** button on the remote controller.

OPERATION

Playing Games (continued) & SLEEP Timer

Making use of MILLENNIUMALIEN

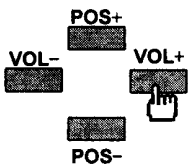

Enter into **MILLENNIUM ALIEN**, there are characters "**SHOOTING START**" flying from right to left. When the characters have flied over, you can begin to shoot. Pressing **VOL+** button can move the battleplane on the lower screen rightward, pressing **VOL-** button can move the battleplane leftward, pressing **POS+/-** button can shoot the bullet out.

When shooting, you should pay attention not to be hurt by opponent's bullet. Every time you are shot by opponent's bullet, your life value will lose one point (there are three points altogether, and SHOOTER on the upper screen will show them.)

There are stages in playing games (shown by **STAGE** on the upper screen.). At the beginning the stage is 1, at this time if you hit the opponent for one time, the opponent's array will lose one person, and your score will gain 100 points.

When stage 1 is finished, the screen will show **Mission Complete** and **BOSS STAGE**. At this time you should pay attention to the quick bullet shot by the flying machine and the **STAGE** is 2, Every time you hit the opponent for one time, your score will increase 100 points.

The game will go on repeatedly in this kind, if your life value has used up, the game is over and the screen will display **GAMEOVER**.

To exit the game playing (during the playing or when in gameover), press **AV/TV** button on the remote controller.

Note: If you want to restart playing games when game is over, you should exit the game first, then reenter into game and begin.

Only buttons on the remote controller can be used during playing games.

Sleep timer

SLEEP timer

Making use of the Sleep timer function allows you to have the set automatically turned off after a preset time, and set the TV set to standby mode.



Press the **SLEEP** button every time, the time displaying on the screen will change in the sequence below:

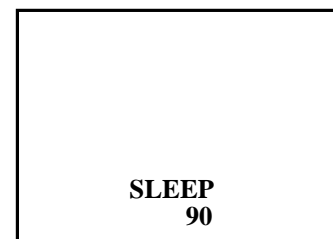
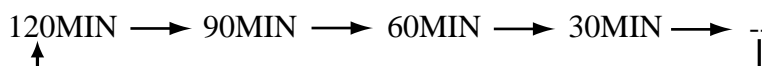

OPERATION

Other functions

CALENDAR function(1800-2299)

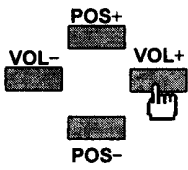

Press **MENU** button repeatedly to select and highlight **CALENDAR** icon, press **VOL+/-** button to enter into calendar interface.

Pressing the **POS+/-** button can check years' calander forward or backward.

Pressing the **VOL+/-** button can check months calendar of some year forward or backward.

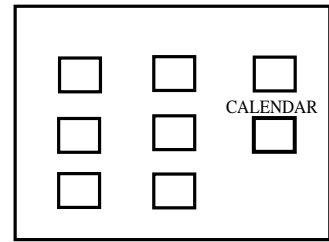

To exit the calendar interface, press **RECALL** button.



CHILD LOCK setting



Press the **MENU** button repeatedly to select and highlight **LOCK** icon.

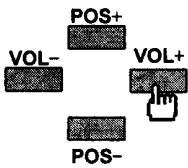
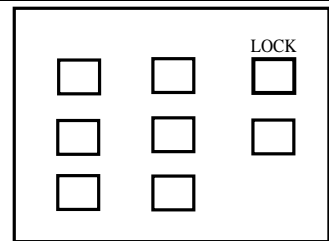

Press **VOL+/-** button to enter into **CHILD LOCK** setting interface, mess **POS +/-** button to select "CHANGE PASSWORD" or to select "ENTER PASSWORD" to set child lock or change child lock.

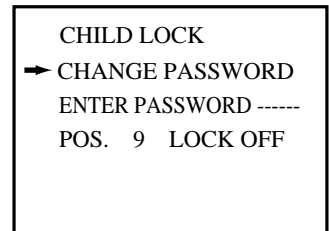

To change password

Select **CHANGE PASSWORD** and press **VOL+/-** button to enter into the menu, input the former password, please press the digit keys to enter the former password (the preset password is 1234)

If the correct password is input, the cursor will move to next row "NEW PASSWORD" automatically, please press the digit keys to enter the new 4-digit password. After inputting, press **POS+/-** button to move the cursor to "ENTRY", and press **VOL+/-** button to confirm and exit the menu.

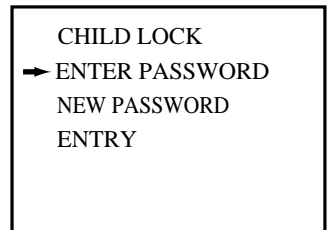

To set child lock or change child lock

Enter into **CHILD LOCK** menu, move the cursor to "ENTER PASSWORD", input the password, if the password is correct, the cursor will move to next row automatically. Pressing **POS+/-** button can change the program number, pressing **VOL+/-** button can set the program's child lock mode in **ON** or **OFF**. When the program's child lock is set **ON**, this program has no content and the whole screen is in yellow.

Note: as long as there is one program whose child lock is set **ON**, the **PRESET** menu can not be entered.

Please enter into the **CHILD LOCK** menu to check. If you want to preset channels regain, please do steps above to set the program's child lock to **OFF** until all the programs are in child lock **OFF**.

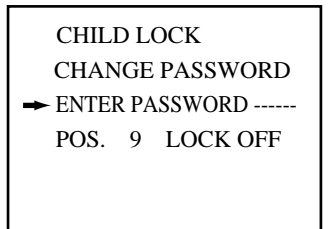

OPERATION

Other functions (continued)

CHANNEL SWAP

Making use of CHANNEL SWAP you can reorder the programs in your favorite order.

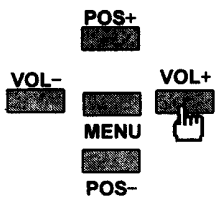

Press the **MENU** button repeatedly to select and highlight **SWAP** icon. Press **VOL +/-** button to enter into CHANNEL SWAP menu.

Press **POS +/-** button to select "**POSITION A: -**" item, then input the desired channel number which you want to swap by pressing "0-9" or "--/---" button.

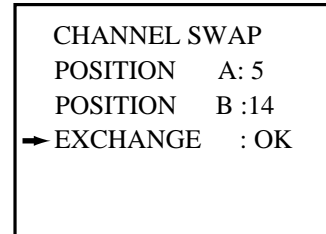
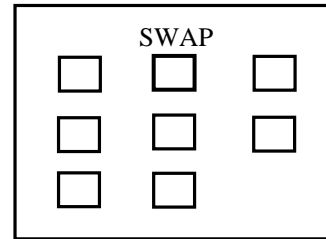

Press **POS +/-** button to select "**POSITION B: -**" item, press "0-9" or "--/---" button to input the channel number which you want to swap to.

Press the **POS +/-** button to select "**EXCHANGE**" item, press **VOL +/-** button to confirm. Then channel A and channel B's programs are swapped.

Super receiving function

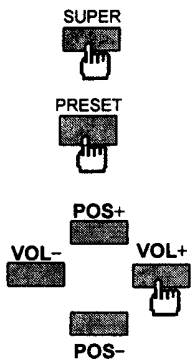

Below we will describe how to make use of super receiving function.

Pressing the **SUPER** button on the remote controller can change the current program's super receiving mode to **ON** or **OFF**.

Or you can press **PRESET** button to enter into **PRESET** menu, press **POS +/-** button to select S-RCV item, press **VOL +/-** button can change the current program's super receiving mode to **ON** or **OFF**.

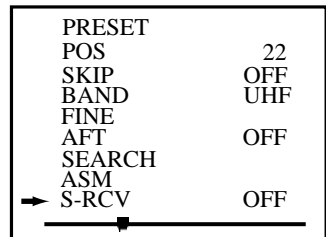
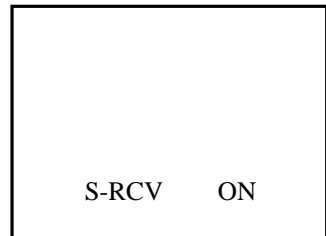

or ON

- Note : 1) After AUTO SEARCH (ASM). all the searched programs are set to S-RCV OFF automatically
 2) When receiving signals are stronger, please set to S-RCV to OFF mode

Program Scan



Press **SCAN** button, the TV set will scan the channels from current channel to higher channels one by one, the upper right corner of the screen will display position number, ever program will be displayed for about 2 seconds and then go on scanning until all the programs are scanned over.

Press **SCAN** button again, the screen will settle at the current scanned program.

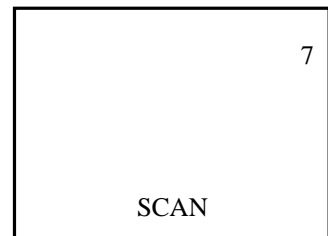

CONNECTING OTHER EQUIPMENT

External Equipment Connections

This set is incorporated with Audio & Video input and output terminals which allow direct connection to external equipments (such as VCR, Video DISC, VCD, Satellite Receiver etc.) for playing back and recording the programs. Refer to the owner's manual of the equipment to be connected as well.

Video playback

The figure below shows how to connect the TV set to the video equipment.

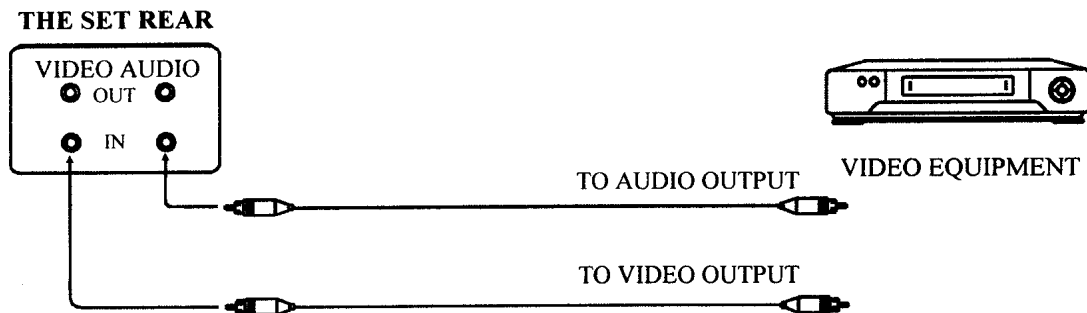

Or you could use another group of AV IN terminals on the front cabinet as follows.

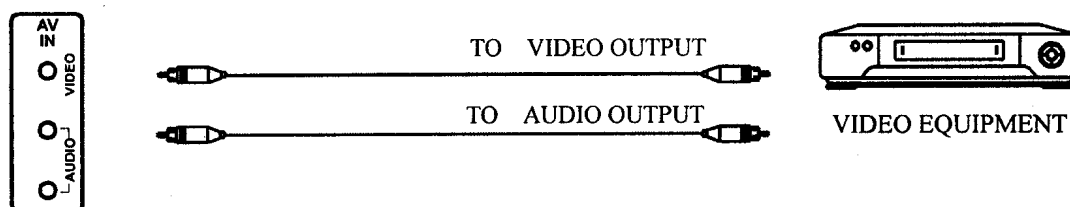

Note: As regards the AV input terminals, connect either the front or rear terminals but not both.

Press the "AV/TV" button on the remote controller to select AV mode, "AV" and corresponding colour system will be displayed on the screen. The picture displayed on the screen is the program played back by the video equipment.

Recording TV program

The figure below shows how to connect the TV set to the VCR

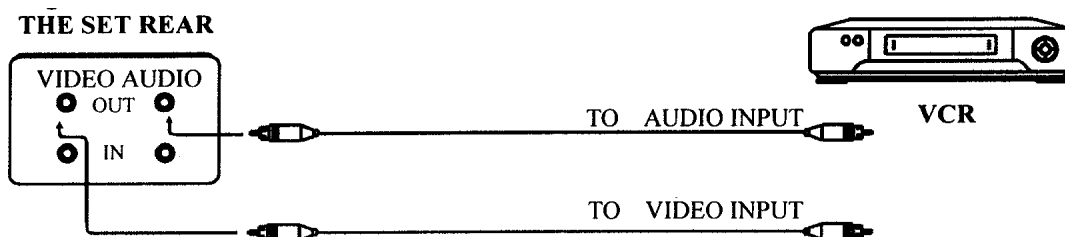

Press AV/TV button on the remote control unit to set the TV receiver to TV mode, and choose the desired channel. At this time, the program recorded is the one displayed on the screen. (The VIDEO/AUDIO output terminals only output TV signals.)

Note: the following mis-operation should be avoided during recording.

* Press STANDBY button or set to AV mode.

* Change the current channel accidentally

OTHERS _____

Troubleshooting Guide

- Before calling service personnel, please check the following chart for a possible cause to the trouble you are experiencing.

Symptoms	Check for the following items
No power, red indicator is not lit up	<ul style="list-style-type: none"> • Be sure the power cord is plugged in.
Poor colour, poor tint	<ul style="list-style-type: none"> • Contrast, colour, tint are not correctly adjusted.
Spots appear on the screen	<ul style="list-style-type: none"> • Possible interferences of automobiles, motorcycle, trolley bus, neon lamps, etc.
Stripes appear on the screen	<ul style="list-style-type: none"> • Super receiving is set ON. When the signals are not too weak, turning on the super receiving may cause stripes. • Possible interference of electronic interference from another TV set, a computer, an electronics game machine, a broadcast station, etc.
Picture is distorted, disturbed or lost	<ul style="list-style-type: none"> • Super receiving is set ON. When the signals are stronger, turning on the super receiving may cause distorted picture, or picture is disturbed or lost.
Double images or “ghosts”	<ul style="list-style-type: none"> • This may be caused by reflections from nearby mountains or buildings. • Check the antenna direction.
Snowy picture	<ul style="list-style-type: none"> • It is possible that the aerial “lead-in” is damaged or comes off. • Check the antenna direction
The remote controller does not work	<ul style="list-style-type: none"> • The batteries may be worn out. • The batteries may be installed with their polarity reversed.
PRESET menu can not be entered	<ul style="list-style-type: none"> • The set may be in AV mode. • There may be at least one program which is in child lock ON mode.
CHANNEL SWAP menu can not be entered	<ul style="list-style-type: none"> • The set may be in AV mode.
CHILD LOCK menu can not be entered	<ul style="list-style-type: none"> • The set may be in AV mode.
TV cabinet creaks	<ul style="list-style-type: none"> • Even if the picture or the sound is normal, changes in the room temperature sometimes make the TV cabinet expand or contract, making a noise. This does not indicate a malfunction.
Unevenness in colour in some parts of the screen.	<ul style="list-style-type: none"> • When the set is switched on, do not shift or move the set around. Sometimes it may develop an unevenness in colour in some parts of the screen. This can be eliminated by switching off the set with the POWER switch and wait for 10 minutes before switching on again.

OTHERS ---

Specifications

Power supply:		AC 240V, 50Hz	
Power consumption:		< 70W	
Dimensions(mm):		590(W) x 448(H) x 468(D)	
Weight(kg):		23	
CRT		51cm	
TV system & channel range			
System	VHF	UHF	CATV
PAL-B/G	2-12	21-69	X~Z+2, S1~S41
Colour system:		PAL-BG, NTSC (AV)	
Sound output:		2.5W	
Accessory:		One remote controller	

* Note: Design and specifications are subject to change without notice.

PALSONIC CORPORATION PTY LTD
1 JOYNTON AVENUE
WATERLOO NSW 2017 AUSTRALIA
TEL:(02)9313 7111
FAX:(02)9313 7555

**PALSONIC CUSTOMER SERVICE
TELEPHONE
AUSTRALIA: 1300 657 888**