

OWNER'S MANUAL

Palsonic

34CM CORDLESS REMOTE COLOUR TELEVISION
MODEL: 3410



Type Tested
Electrical
Safety

AS/NZS 3250 Lic 4163
Standards Australia
APP No: N15957

PALSONIC CORPORATION PTY LTD
1 JOYNTON AVENUE
WATERLOO NSW 2017 AUSTRALIA
TEL:(02)9313 7111
FAX:(02)9313 7555
www.palsonic.com.au

**PALSONIC CUSTOMER SERVICE
TELEPHONE
AUSTRALIA:1300 657 888**

Congratulations on your purchase of this Palsonic colour television receiver.
We recommend that you thoroughly read this manual before use to fully enjoy the many functions and excellent effects of this receiver.
Retain is manual in an easily accessible location for future reference.

Contents

Main features	2
Notes for operation	3
Cautions for safety.....	3
Installation and appearance	4
Antenna connection	4
Battery installation	4
Appearance	5
The remote controller	6
Operation	7
Turning the power on/off	7
Menu operation	7
Picture menu	8
Preset menu	8
Function menu	10
Channel selection	11
Picture and volume adjustment	12
Picture mode selection	13
Other functions	13
External equipment connections	16
Trouble shooting	18
Specifications	19

Main features

- **Hyperband.**
- **Auto/manual search.**
- **Voltage synthesised system**
- **100 preset channels.**
- **TV system: PAL-B/G, NTSC-4.43/3.58 (AV).**
- **Full function remote control & English on screen menu display**
- **No-signal blue background display and AUTO-POWER-OFF function.**
- **Four picture mode settings.**
- **Sound mute function.**
- **Sleep timer.**
- **AV IN/OUT S-VHS operation function.**

NOTES FOR OPERATION

- * Do not let the TV set be in standby condition for a long period of time. When it is not in use, please turn off the power supply and remove the power plug. When it is to be left for a prolonged period of time, it is recommended to disconnect the connection to the outdoor aerial, to avoid thunder strike.
- * Please follow cautions for safety in the TV set instructions, and all warnings and descriptions denoted on the TV set.

■ Cautions For Safety

Note: This TV set can be operated on an AC power of 240V, 50Hz. You should not use power supply of the other type.

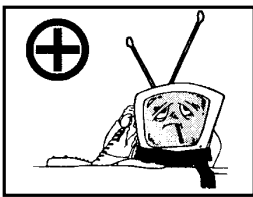

When an unusual situation occurs, turn off the power switch at once and remove the plug from the wall outlet. Contact a qualified service department in your local area.

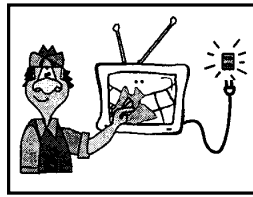

In order to wipe dust off the picture tube or off the cabinet, you should remove the power plug from the wall outlet first. You can wipe lightly with a piece of dry, clean, soft cloth.

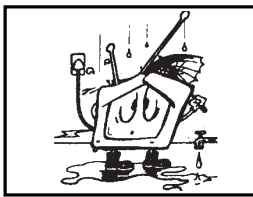

Do not expose the TV set to rain or excessive moisture, to prevent fire disaster or electric shock. Avoid using the set in very warm or damp places. Never use it in a bathroom.

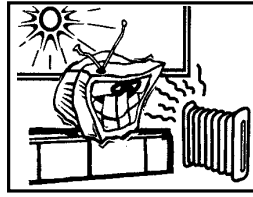

The TV set should be placed on an adequate place without exposing it to direct sunlight and other sources of heat to prevent the deformation of the cabinet or damage to components.

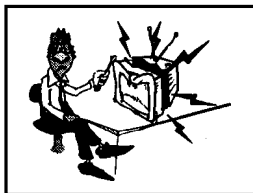

There exists High Voltage in this TV set. Do not remove the cover to avoid danger.

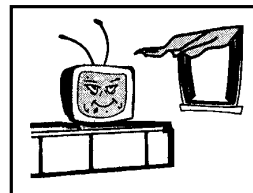

Do not cover the ventilating holes in the cabinet. Keep a space of more than 5 cm from the walls to the TV set, to guarantee the good ventilation.

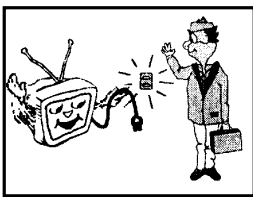

When the TV set is to be left unattended, please turn off the power switch and remove the plug from the wall outlet.

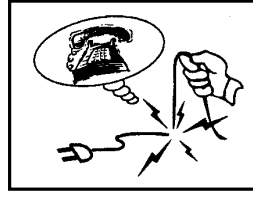

When the power cord or the plug is damaged, please contact a qualified service department to get service.

Installation and appearance

■ Antenna connection

To ensure a bright-coloured and clear picture, you should use an outdoor aerial or CATV cable. If the signals are strong enough, you may use an indoor aerial.

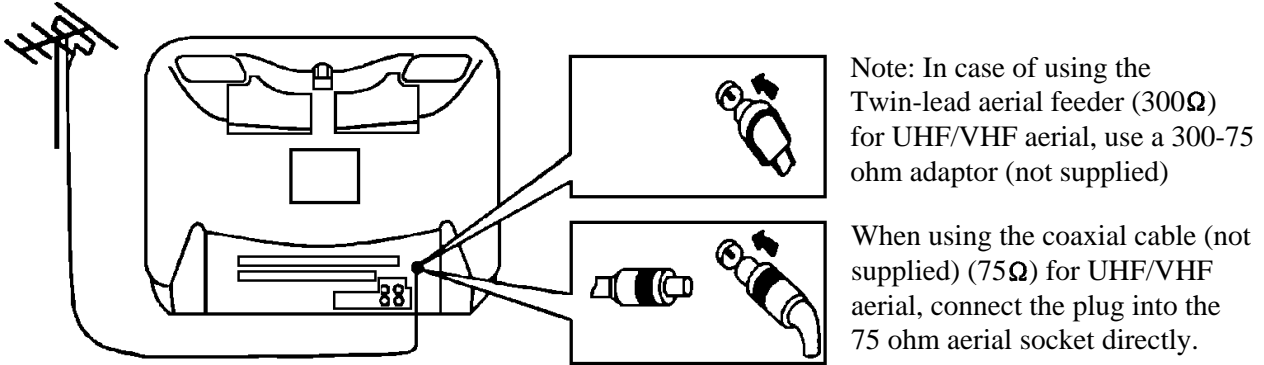

Note:

When you connect the outdoor aerial cable to the aerial terminal on the TV set, please turn off the power switch on the TV while connecting the antenna lead.

In thunder and lightning, weather, please disconnect the connection to the outdoor aerial to avoid thunder/lightning strike.

■ Battery Installation:

- 1) Remove the back battery cover.

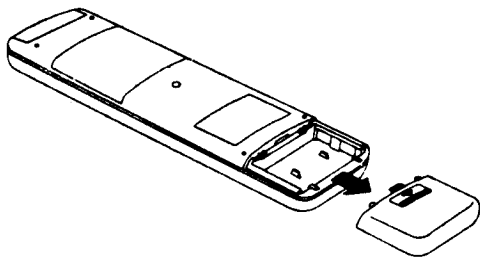

- 2) Insert two size AAA batteries according to the polarity indication inside the remote controller.

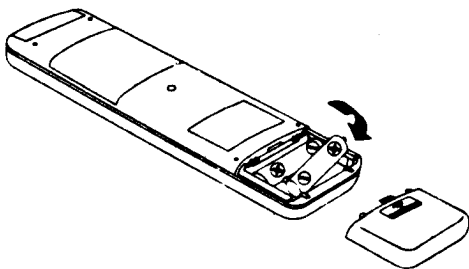

Effective range of the remote control operation

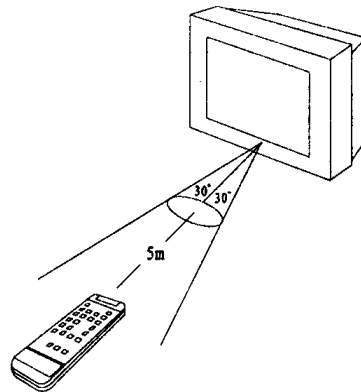

1. When the remote controller is not used for an extended period of time or the batteries are worn out, please remove the batteries in time to avoid battery leakage.
2. Avoid moisture and mechanical shock to the remote controller.

■ Appearance

Front view

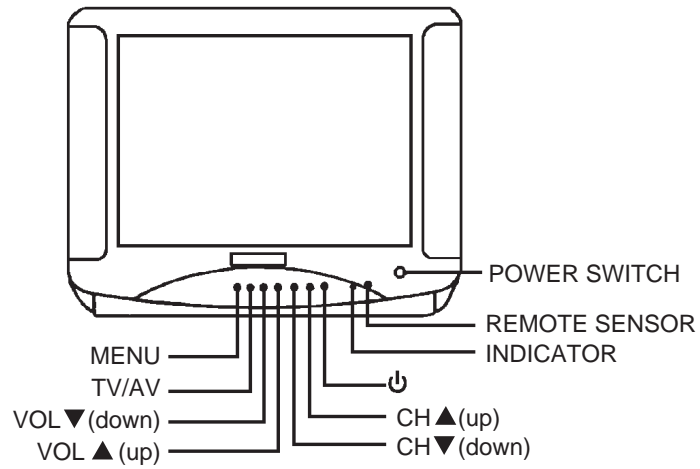

Note: Functions of MENU, , VOL ▲/▼, CH ▲/▼ and TV/AV are also provided to the remote controller.

Back view

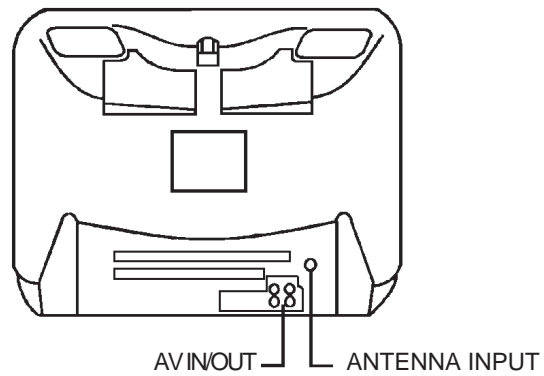

The remote controller

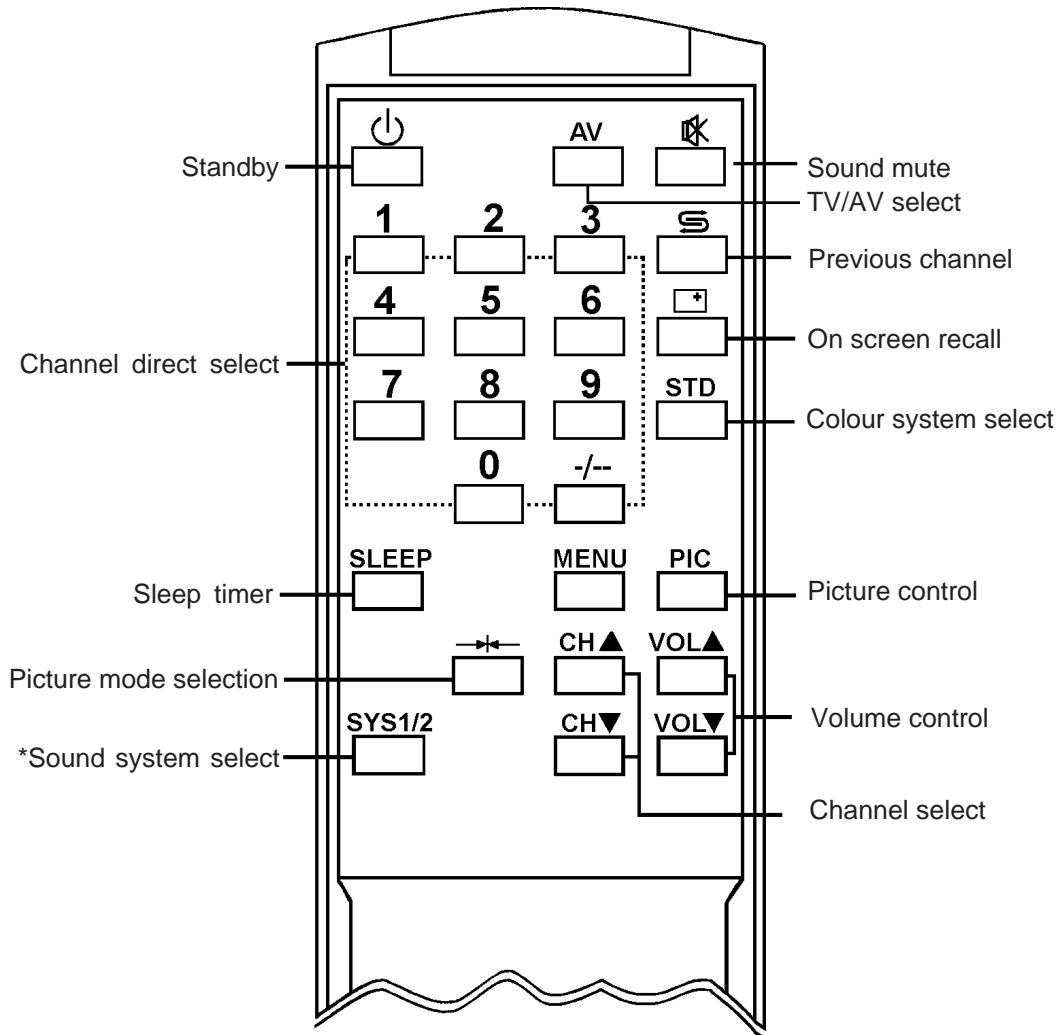

* NOTE: this TV model's RF sound system is BG only. Therefore the **SYS1/2** button on the remote controller is ineffective in sound system selection. Similarly in the **Preset** and **Function** menus the **SYS** item (sound system selection item) is ineffective.

Operation

■ Turning the power on/off

1. Connect the power, push the main power switch, the red indicator is on, the set is in standby mode.
2. Push the **⏻** button on the remote controller to turn on the set when the set is in standby, this time, the green indicator is on, on the upper right corner of the screen will display channel number, colour and sound system. Or you can push the **CH ▲/▼** button to turn on the set when in standby.
3. You can push the **⏻** button to switch the set to standby mode when in operation mode, this time the green indicator is off, the red indicator is on.
4. Push the main power switch to turn off the set completely and confirm that all indicators go out.

Note: If there are no input signals for the TV when the set is in TV receiving mode, a blue background will appear on the screen. After 5 minutes if there are still no signals to the TV, it will enter into standby mode automatically.

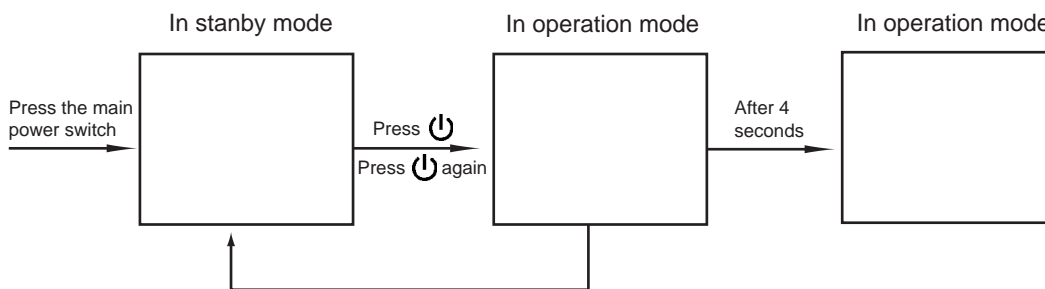

■ Menu operation

You can select adjustment items by making use of the menu. Press the **MENU** button to display the main menu:

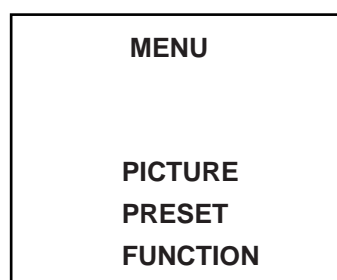





Press the **CH ▲/▼** button to select items upward or downward (the selected item is highlighted in red, while others in green). The item sequence is:



Press the **VOL ▲/▼** button to enter into the sub-menu. To exit the menu press the MENU button.

Note: the menu displayed on the screen will disappear automatically in 10 seconds if not in operation.

1. PICTURE menu







		26
		26
		26
		31
		31

Making use of the PICTURE menu can adjust the picture effect according to your personal preference and it will be stored as picture memory mode automatically.

Press the **CH ▲/▼** button to select the item (the selected item is highlighted in red). Press the **VOL ▲/▼** button to adjust it. The range is 0-63.

Press the MENU button to exit to the main menu.

Below are the characteristics of the picture adjustment item.

OSD		
	0 ← Green bar moving → 63	
Pressing	VOL▼	VOL▲
Item		
 (BRIGHTNESS)	Darker	Brighter
 (COLOUR)	Lighter	Stronger
 (CONTRAST)	Weaker	Stronger
 (TINT)	Purplish	Greenish
 (SHARPNESS)	Weaker	Stronger

Note:

* TINT is effective only in NTSC system.

2. PRESET menu

PROG	28	SYS 1
SKIP	OFF	AUTO
AFT	ON	SEARCH
BAND	U	MANUAL



Making use of the **PRESET** menu can fulfil the function of auto-search, search. manual search , channel and band selection. AFT and skip on/off.

Press **CH ▲/▼** button to select the item. (the selected item is highlighted in red). Press the MENU button to exit to the main menu.

1) PROG (program)

Select the current program number while "**PROG**" is highlighted. Press **VOL ▲/▼** button to increase or decrease the program number progressively.

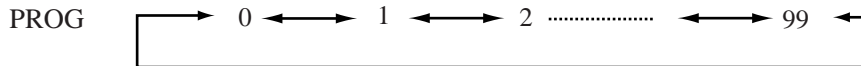

2) SKIP-ON/OFF

Press **CH ▲/▼** button to highlight **SKIP ON/OFF**. Press **VOL ▲/▼** button to toggle between **SKIP ON** and **OFF**. When "**SKIP ON**" is set, the current channel program will be skipped. Making use of this function can skip some unwanted channel, say 5, 11, next when you press **CH ▲/▼** button to select channel, 5, 11 channel will be skipped.

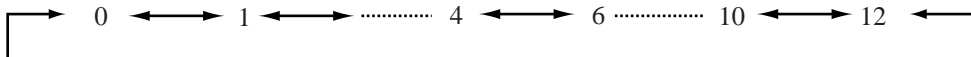

* Press the channel direct select button can select the skipped channel.

3) AFT ON/OFF

Making use of the AFT function can automatically fine tune the channel.

Select and highlight **AFT**, pressing **VOL ▲/▼** button it toggles between **ON** and **OFF**. When in **AFT ON**, it can automatically fine tune the channel. In normal circumstances, please set **AFT ON**.

When in the process of manual search, **AFT** is set "**OFF**" automatically.

4) Band Selection

Press the **CH ▲/▼** button to highlight **BAND**. Press the **VOL ▲/▼** button to select band. The change sequence is

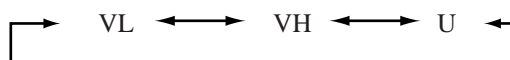

5) SYS (sound system)

This item is used to select sound system. Since this TV model's RF sound system is B/G only, this item gets into ineffectiveness in sound system selection.

6) Auto - search (AUTO)

Press **CH ▲/▼** button to highlight *AUTO*. Press **VOL ▲/▼** button the set will automatically search and store the active TV signals in your local area from lower band to higher band in the sequence of VL→VH→U with the green bar moving rightward. When a station is located, the set will store the signals with a channel number from 0. When all the signals are searched and stored, the TV returns to 0 channel automatically, auto-search is finished.

* After auto-search, all programs colour system is set to AUTO and in AFT-ON mode.

* During the process of auto-search, if **⏻**, **MENU** or **CH ▲/▼** button is pressed, the searching is interrupted. Press **VOL ▲/▼** button the searching begins again.

7) SEARCH

Making use of SEARCH function will store a TV program at a referred channel position.

Select a channel number, when **SEARCH** is highlighted, press **VOL ▲/▼** button, the set begins to search for signals upward or downward from current channel. When a station is located, the searching stops and the program is stored into the referred channel position.

Repeat the above step and store another program signals into another position. If two channels are same, the previous will be deleted.

When the searching is finished, to store the program signals you should press the **MENU** button to exit the menu and the program signals are stored automatically.

* When the tuning changing reaches the highest (lowest), the searching turns to next band's lowest (highest) and continues searching. If the signals are not the signals you desire, you can press the **VOL ▲/▼** button again until the desired signals are searched.

8) Manual search (MANUAL)

When some program's picture or sound is not good, you can make use of this function to fine tune the tuning voltage.

Press **VOL ▲/▼** button to highlight *MANUAL*. Press **VOL ▲/▼** successively, the set begins searching upward or downward. When the picture has obtained the optimum effect, release the button.

To store the effect you should press the **MENU** button to exit the menu and the effect is stored automatically.

3. FUNCTION menu

STD	AUTO
SYS	1
BLUE	ON

Making use of the **FUNCTION** menu can select BLUE ON/OFF and current channel's colour and sound system.

Press **CH ▲/▼** button to select item (the selected item is highlighted). Press **MENU** button to exit to the main menu.

1) STD (colour system) selection.

In this TV model the colour system is automatically identified. In normal circumstances, please set colour system to **AUTO**.

2) SYS (sound system) selection.

In this TV model this item is ineffective. (Refer to the **NOTE** on page 6)

3) BLUE ON/OFF selection.

Select and highlight **BLUE ON/OFF**. Press **VOL ▲/▼** button to select ON or OFF. When "**BLUE ON**" is selected, blue background will appear on the screen automatically when no input signals, and the sound is mute. After 5 minutes the set will cut off automatically.

■ Channel selection

1. Using direct select buttons

1) Single digital method (0~9).

You can select any one of 0~9 channel position directly by pressing the number button accordingly.

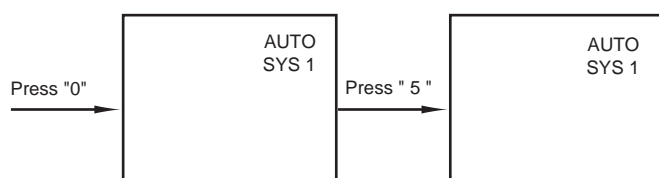

2) Two digital method (10~99).

Press **"-/-"** button until the symbol **"--"** is displayed on the screen. In this mode you can choose any one of two digit channel by pressing the number buttons accordingly. For example, if you wish to receive channel 25, press **"2"** button, then press **"5"** button.

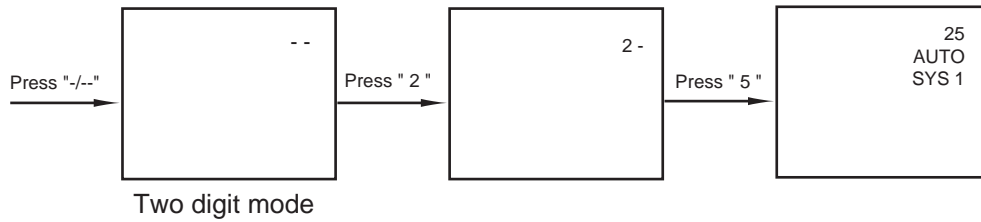

2. Using CH ▲/▼ button

Press CH ▲/▼ button, the channel number will be increased or decreased progressively.

3. Making use of S button

Press S button to swap the currently viewed channel with the previous channel.

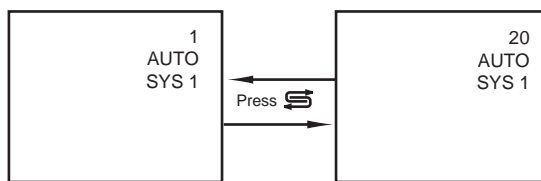

Picture and volume adjustment

1. Picture adjustment

Press PIC button repeatedly, on-screen display will change in the sequence below

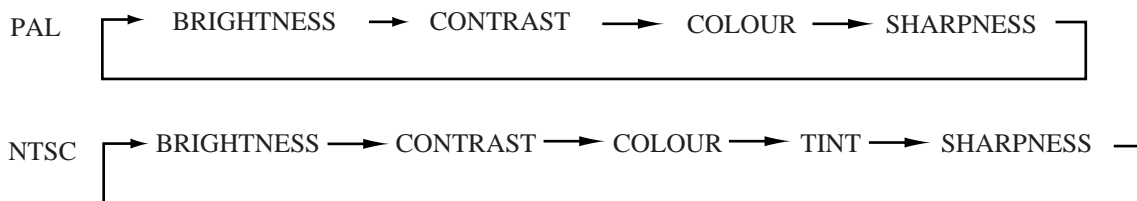

Press VOL ▲/▼ button to adjust the level. For example, to adjust brightness:

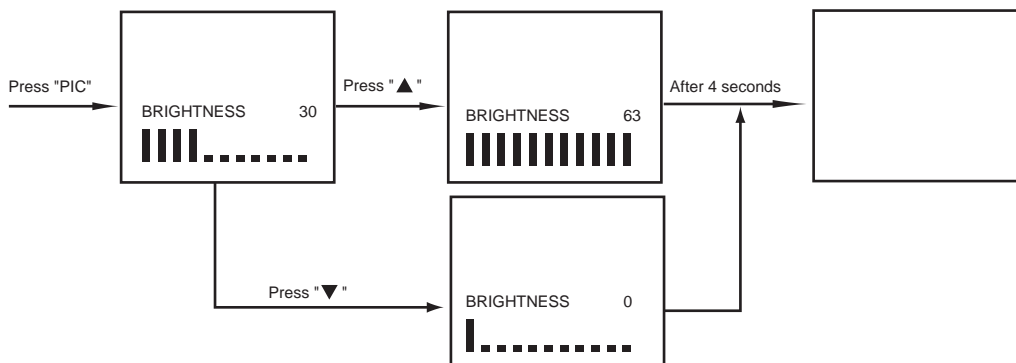

(Note: this button's function is as same as the function of the PICTURE menu of the main menu, refer to PICTURE MENU on page 8.)

2. Volume adjustment

You can press the **VOL ▲/▼** button to adjust the volume, and the green bar will move rightward or leftward, the volume output range is 0-63.

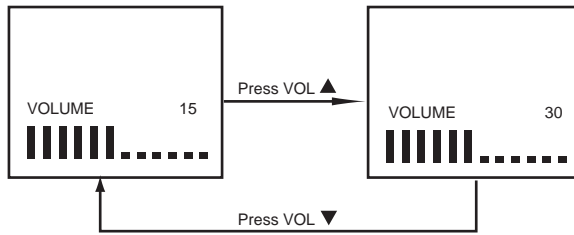

You can press the  button to mute the sound. Press the  button again or **VOL ▲/▼** button. The sound is restored to normal.

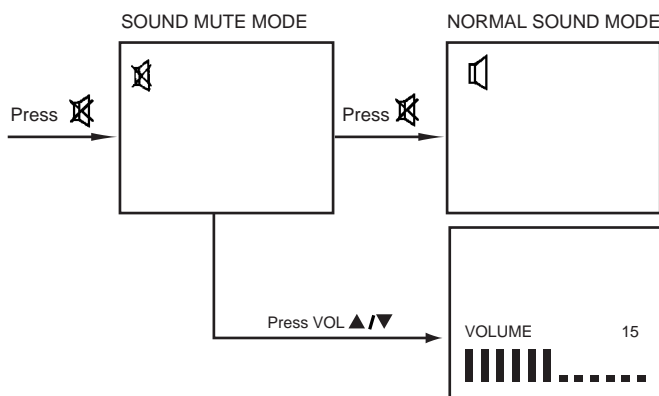

Picture mode selection

You can select the picture quality instantly among three presets modes and one user-set mode. Press the  button to select the desired picture quality. **DYNAMIC**, **STANDARD**, **MILD** and **MEMORY** (user-set) can be selected cyclically.

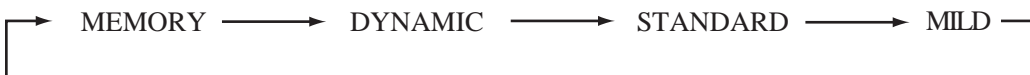

Output Item / Mode	Brightness	Colour	Contrast	Tint	Sharpness
DYNAMIC	31	31	47	31	31
STANDARD	31	31	31	31	31
MILD	31	31	21	31	31
MEMORY	The picture quality you set				

■ Other functions

1. Retain on-screen display

Press the  button and the upper right corner will display the current channel number and TV system. After 4 seconds the display on the screen will disappear.

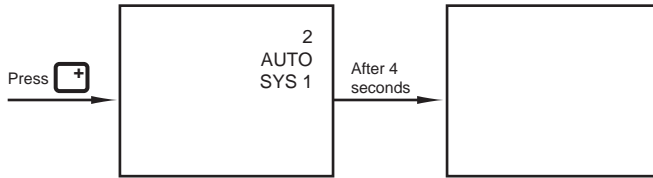

In VIDEO mode, it will only display VIDEO 1 (or VIDEO 2) and the colour system.

2. TV colour system selection

Press the STD button and each time the colour system displayed on the screen will change in the sequence of



If the system is not set correctly, the picture will have no colour or the colour will be abnormal. Press the STD button to select the right colour system to obtain normal colour (Refer to the following table).

	COLOUR SYSTEM	Colour Sub-Carrier	Vertical Frequency
AUTO	PAL (RF/VIDEO)	4.43MHz	50Hz
	NTSC 3.58 (VIDEO)	3.58MHz	60Hz
PAL	PAL (RF/VIDEO)	4.43MHz	50Hz
	PAL 60 (VIDEO)	4.43MHz	60Hz
N358	NTSC 3.58 (VIDEO)	3.58MHz	60Hz
N443	NTSC 4.43 (VIDEO)	4.43MHz	60Hz

3. SLEEP timer

Using the SLEEP button allows you to have the appliance automatically turned off after a preset time (the time range will be as long as 120 minutes), and set the appliance to standby mode. At every press of the button the setting time will be decreased by 30 minutes.

When the remaining time is 5 minutes left, it will be displayed once every 2 minutes for 4 seconds

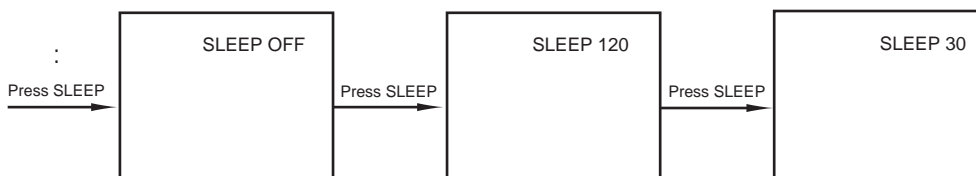

When the SLEEP timer is functioning, if you press SLEEP button again, the TV will display the remaining time. If the power is switched off, the SLEEP timer will be cancelled. You must set it again if wanted.

4. TV/AV selection

Press the TV/AV button on the set or AV button on the remote controller to select TV or AV mode.

When the TV is working at RF receiving mode, press AV button the set will be switched to AV1, the screen displays AV1 and colour system; Press the button again and the set will be switched to AV2, the screen displays AV2 and colour system. Press the button once more, the set will be switched to TV mode and the screen displays current TV channel.

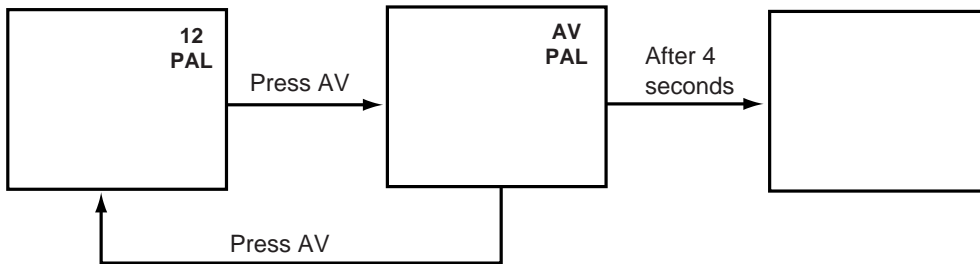

Note:

- 1) When receiving broadcasting TV program (the TV signals are input through aerial terminal), press the AV button to switch the set to TV mode.
- 2) When receiving programs played back by Video DISC, VCR, Satellite receiver, VCD (the signals are input through AV terminals), please set the receiver to AV mode.

External equipment connection

This set is incorporated with Audio & Video input and output sockets which allow direct connection to external equipment (such as VCR, Video DISC, VCD, Satellite Receiver etc.) for playing back and recording the programs.

1. VIDEO PLAYBACK

The figure below shows how to connect the TV set to the video equipment.

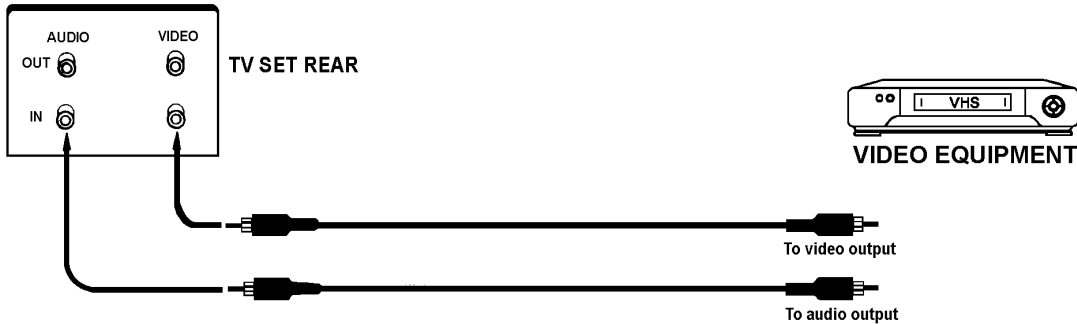

NOTE: The VIDEO equipment may be VCR, Video DISC, VCD or Satellite Receiver.

Press the "TV/AV" button on the set or "AV" button on the remote controller to select AV mode, "AV" and corresponding colour system will be displayed on the screen. The picture displayed on the screen is the program played back by the video equipment

2. RECORDING FROM THE TV SET

The figure below shows how to connect the TV set to the VCR.

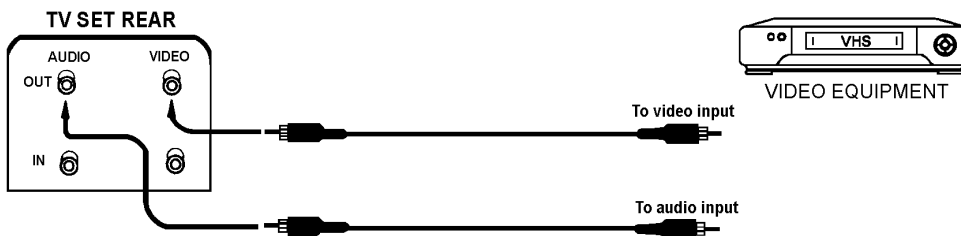

Press AV button on the remote control unit to set TV mode, and choose the desired channel. At this time, the program recorded is displayed on the screen.

Note: the following mis-operation should be avoided during recording.

- * Press STANDBY button or set to VIDEO mode.
- * Change the current channel accidentally.

3. DUBBING

The picture below shows how to connect TWO VCRs to the TV for dubbing one from the other.

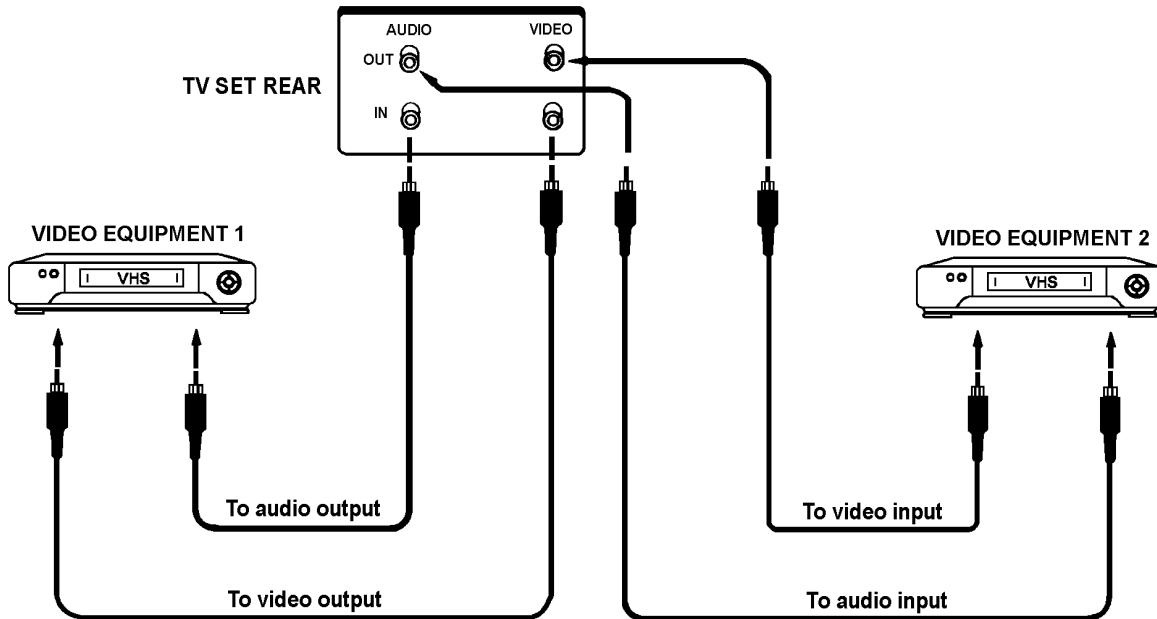

Press AV button on the remote control unit to select AV mode before dubbing, "AV" will be displayed on the screen. The TV set will act as a monitor to help you edit while dubbing.

NOTE: The set MUST remain in Video mode and MUST NOT be switched off during the session.

TROUBLE SHOOTING

If any problem arises in the operation of your set, first check through this list of symptoms and correction. Should the problem be unsettled, unplug the set and contact your dealer.

Symptoms	Check these things	Try these adjustment
<ul style="list-style-type: none"> No picture, no sound. 	<ul style="list-style-type: none"> Be sure power cord is plugged in. May be station trouble. Check antenna connections. Maybe in AV mode. 	<ul style="list-style-type: none"> Press POWER BUTTON Try another channel. Press AV button once.
<ul style="list-style-type: none"> Poor sound, picture OK. 	<ul style="list-style-type: none"> May be station trouble. May be local interference from another appliance. Check antenna connections. 	<ul style="list-style-type: none"> Try another channel. Reorient antenna. Adjust VOLUME control.
<ul style="list-style-type: none"> Poor picture, sound OK. Snowy picture Lines in picture Distorted picture Weak picture. 	<ul style="list-style-type: none"> May be station trouble. Check antenna connections. Check antenna for broken wires. May be local interference from another appliance. 	<ul style="list-style-type: none"> Try another channel. Reorient antenna. Adjust BRIGHTNESS control. Adjust CONTRAST control.
<ul style="list-style-type: none"> Multiple images (Ghost) 	<ul style="list-style-type: none"> May be station trouble. Check antenna connections. May be local interference. 	<ul style="list-style-type: none"> Try another channel. Reorient antenna.
<ul style="list-style-type: none"> Poor colour or no colour 	<ul style="list-style-type: none"> May be station trouble. Check antenna connections. Check antenna for broken wires. May be local interference from another appliance. 	<ul style="list-style-type: none"> Try another channel. Reorient antenna. Adjust COLOUR control.
<ul style="list-style-type: none"> Remote control does not work. 	<ul style="list-style-type: none"> Be sure power cord is plugged in Check battery in Remote Control Hand Unit. 	<ul style="list-style-type: none"> Change batteries.
<ul style="list-style-type: none"> No picture, Sound OK. 	<ul style="list-style-type: none"> Station may be in trouble. 	<ul style="list-style-type: none"> Try another channel. Adjust CONTRAST control.

SPECIFICATIONS

Power Supply : AC 240V, 50Hz
Receiver Channel : VHFL 0~5, 5A; VHFH 6~11; UHF E21-E69
Cable Channel : S1-S41 (Hyperband)
TV System : PAL-B/G, NTSC 3.58 /4.43
Dimension (mm) : 430 (W) x 339 (H) x 370 (D)
Weight : 12 kg
CRT : 34cm
Power Consumption : 60W
Antenna Impedance : 75 ohm

Remote Control Unit

Power Supply : DC 3V (2 x UM-3)
Accessories : one remote controller

Note : Design and specifications are subject to change without notice.

PALSONIC CORPORATION PTY LTD
1 JOYNTON AVENUE
WATERLOO NSW 2017 AUSTRALIA
TEL:(02)9313 7111
FAX:(02)9313 7555
www.palsonic.com.au

**PALSONIC CUSTOMER SERVICE
TELEPHONE
AUSTRALIA: 1300 657 888**