

NEC

Colour Television

INSTRUCTION MANUAL

PF32W503



Table of contents

Safeguards	2	To turn off the TV automatic(off time)	18
INTRODUCTION		Sleep time setting	19
Features	3	To select the screen color	20
Installation	3	To select demo	20
To connect the aerial	4	To select the auto volume control	21
To prepare the remote control	4	To select channel lock	21
Identification of controls	5	To select child lock	21
Remote control	7	Watching picture in picture	22
Turning the Power ON/OFF	8	To watch a TV or an external source as a sub-picture	23
Turing the power on/off	8	To switch the main and sub picture of the pip	24
Auto power off	8	Connecting other machines like VIDEO	25
Last mode memory	8	Names and functions of connective terminals	25
Tuning the TV channels	9	Connecting VIDEO	26
Auto setup system	9	Connecting at AV2(SCART)	27
Tilt	9	Connecting with S picture VIDEO	28
Edit	10	Connecting with VIDEO CAMERA(CAMCORDER)	29
Convenient picture control	11	Connecting with AUDIO set	30
To select the picture mode	11	Connecting DVD PLAYER	31
Enjoying panorama and zoom picture	12	Broadcast transmission systems in each country	31
Convenient sound control	13	Viewing teletext(option)/use of the teletext buttons	32
To volume control	13	To select the text mode	32
To mute the sound	13	Split screen	32
To display the position number	13	Page select	32
To select the sound mode	14	Index	32
To adjust the sound balance	15	Mix	32
To adjust sound frequency	15	Picture	32
To select sound effect	15	Size	32
Enjoying stereo and bilingual broadcasts	16	Reveal	33
Stereo programs	16	Hold	33
Bilingual programs	16	Cancel	33
Using other menus	17	Subcode	33
To set clock	17	Specification	34
To turn on the TV automatically(wake time)	18	NEC Service Centres	35

SAFEGUARDS

To operate your receiver at the peak performance, please read this Instruction Manual carefully and retain it for the future reference.

- **Water and Moisture** : Never install the set in the following places : in the bathroom, in a wet basement(Dripping or splashing water).
- **Heat** : Never place the set near sources(e.q. radiator).
- **Ventilation** : Do not cover the ventilation opening in the cabinet. Accidental contact with high voltage components could result in electric shock. Never place the set in a confined space such as a bookcase or built-in cabinet, unless proper ventilation is provided when install the T.V set, make the gap at least 10cm from the wall.(at back, top, and side of T.V set)
- The ventilation should not be impeded by covering the ventilation openings with items, such as newspapers, table-cloths, curtains, etc.
- No naked flame sources, such as candles, should be placed on the apparatus.
- When mains switching off, the apparatus is not completely switched off from the mains. To disconnect it from the mains, you have to unplug mains.
- **Object Entry** : Do not insert foreign objects, such as needles and coins, into the ventilation openings.
- **Lightning Striking** : You should disconnect your set from the main and the aerial system during thunderstorms.
- **Cleaning** : Unplug the set from the main before cleaning. Do not use liquid cleaners of aerosol cleaners. Use only a lightly dampened soft cloth.
- Do not place liquids including flower vases and vessels filled with chemicals or water, etc. on the top of the unit. Keep the inside of the unit free from foreign objects such as hairpin. If hazardous objects fall inside of the unit, unplug it immediately and call a qualified technician for removal.
- When you don't use the set for an extended period during vacation or other occasions, always make sure of switching off the MAIN POWER(ON/OFF) SWITCH of the TV set.
- Do not place this television equipment on an unstable cart, stand, or table. The television equipment may fall, causing serious injury to a child or adult, and serious damage to the equipment. Use only with a cart or stand recommend by the manufacture's instructions, and should use a mounting kit approved by the manufacture.
- When replacement parts are required, be sure the service technician has used replacement parts specified by the manufacture that have the same characteristics as the original parts. Unauthorized substitutions may result fire, electric shock, or other hazards.
- Upon completion of any service or repairs to the set, ask the service (as specified by the manufacture) to determine that the set is in safe operating condition.
- If anything goes wrong, don't try any fix it yourself, get a qualified service agent to look at it.
- The appliance is not intended for use by young children or infirm persons without supervision.
- Young children should be supervised to ensure that they do not play with the appliance.

NOTE

If the receiver is moved or placed in a different direction, the MAIN POWER (ON/OFF) SWITCH must be switched off for at least 15 minutes in order to take out a colour strain on the screen.

INTRODUCTION FEATURES

Double Window

You can enjoy two programs simultaneously by splitting the screen in two.

16:9 screen

You can select a desired 4:3 screen mode as well as the 16:9 picture mode.

A variety of AV terminals for external equipment connection.

- Two sets of video/audio inputs on the rear and one set on the right.
- S-VIDEO terminals.
- One set of A/V output (TV signal) terminals.
- One set of SCART JACK input/output on the rear.

Selectable picture and selectable sound

Allows one-touch selection of your favorite picture quality and tone quality.

NICAM and German stereo/bilingual broadcasts receivable

PIP (Picture-in-Picture)

The PIP function can show another picture on the main picture simultaneously.

Off-timer and Wake-timer

Turns off the TV automatically and will turn it back on at a preset time.

Curtain Effect

When the power on/off, the screen is displayed like a curtain and you can hear a beep.

Split screen

You can enjoy two programs simultaneously (Main picture & Teletext Picture).

Component Input

You can enjoy better DVD-Picture with use the Exclusive terminals of DVD (Cr & Cb).

INTRODUCTION

Installation

- **INSTALL** the unit in a room where direct light will not fall upon the screen. Total darkness or a reflection on the picture screen may cause eyestrain. Soft and indirect lighting is recommended for comfortable viewing.
- **ALLOW** enough space between the unit and the wall for proper ventilation.
- **AVOID** excessively warm locations to prevent possible damage to the cabinet or components.
- **RATED VOLTAGE**: 110-240V~, 50/60Hz.

Automatic degaussing

All colour television receivers are sensitive to magnetic influences usually caused by either moving the receiver from one place to another or using certain electrical appliances near the receiver. This residual magnetism, as it is called, sometimes causes distortion which gives rise to "blotchy" areas of colour in the picture. To avoid these effects, the receiver incorporates an automatic degaussing switch.

This circuit removes any residual magnetism in the metal parts of the picture tube and ensures that each time the receiver is turned "ON" using the main switch, the purity of the colours displayed on the screen remains true and lifelike. If the unit is moved or made to face a different direction, the main switch must be off at least 30 minutes in order for the automatic degaussing circuit to operate properly.

INSTALLATION

To connect the aerial

Optimum reception of colour requires a good signal and will generally mean that an outdoor aerial must be used. The exact type and positioning of the aerial will depend upon your particular area.

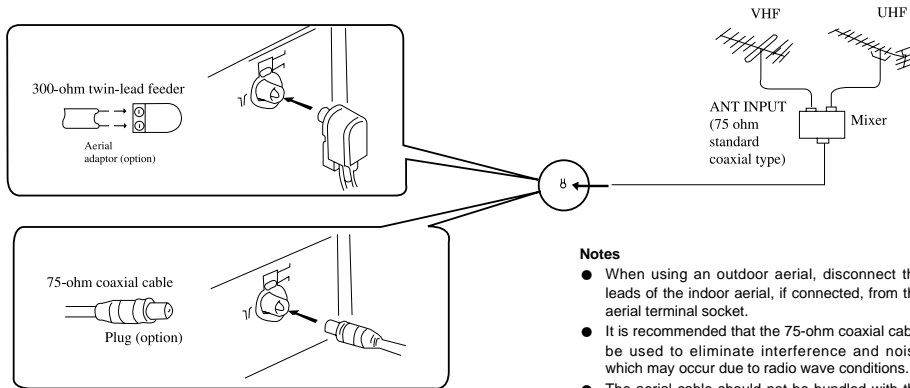

Notes

- When using an outdoor aerial, disconnect the leads of the indoor aerial, if connected, from the aerial terminal socket.
- It is recommended that the 75-ohm coaxial cable be used to eliminate interference and noise which may occur due to radio wave conditions.
- The aerial cable should not be bundled with the power cord and the like.

Using the ANT(attenuator) switch (See page 6)
When visual interference occurs, set the ANT switch to ON using a small screwdriver.

To prepare the remote control

Battery installation

- 1 Remove the battery cover.



- 2 Insert two size AA batteries matching the +/- polarities of the battery to the +/- marks inside the battery compartment.

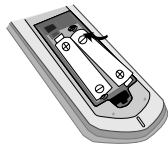

Tips for remote operation

Effective range

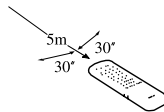

- When the remote control will not be used for a long period of time or when the batteries are worn out, remove the batteries to prevent leakage.
- Do not throw the batteries into a fire. Dispose of used batteries in the specified manner.
- Do not drop, dampen or disassemble the remote control.

IDENTIFICATION OF CONTROLS

*The following describes the name of each part of the TV and remote control.

FRONT

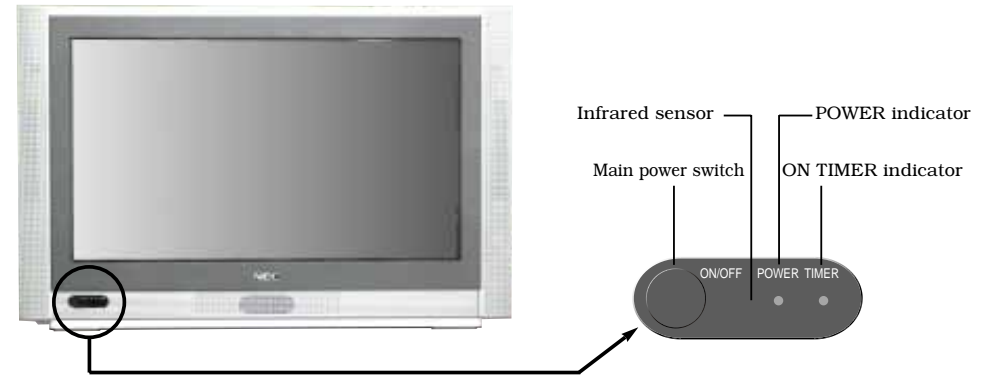

SIDE

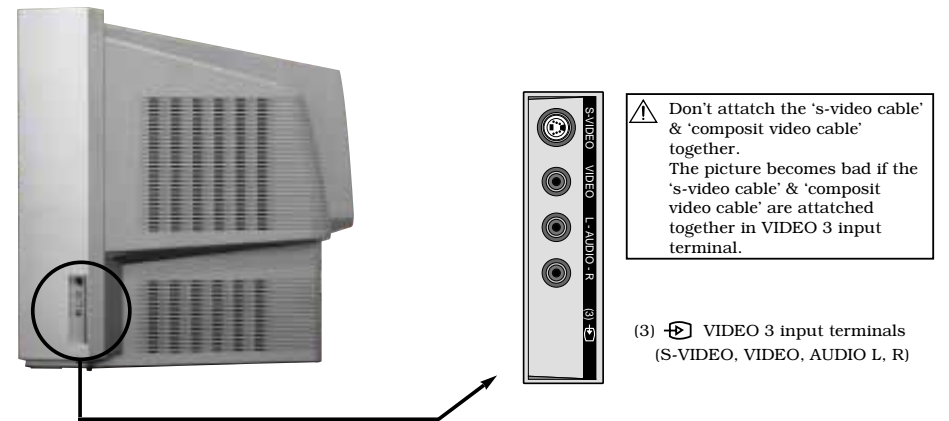

- (3) VIDEO 3 input terminals (S-VIDEO, VIDEO, AUDIO L, R)

TOP

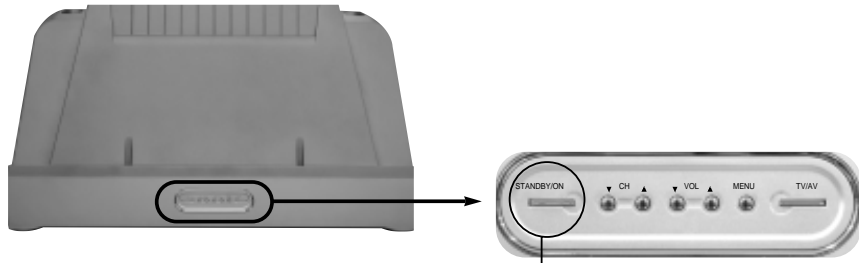

Under this button pressed once, TV goes to the state of STAND BY.

BACK

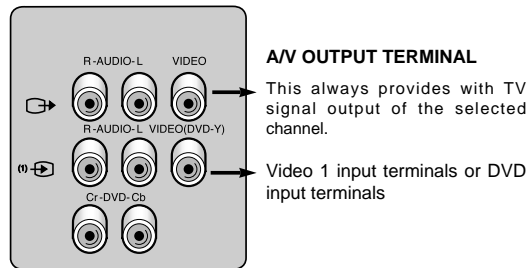
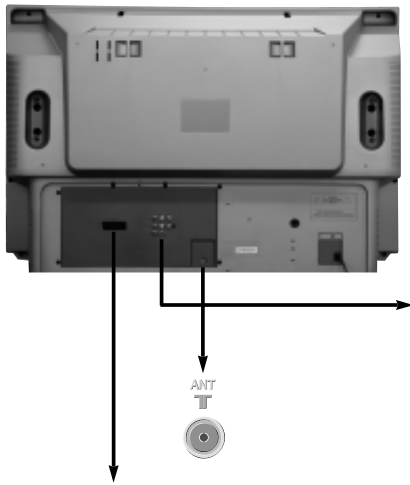

AV OUTPUT TERMINAL

This always provides with TV signal output of the selected channel.

Video 1 input terminals or DVD input terminals



VIDEO 2(SCART JACK) input/output terminal (SCART does not supports S-VIDEO)

AV OUT OF SCART TERMINAL will provide with TV signal output of the selected channel.

REMOTE CONTROL

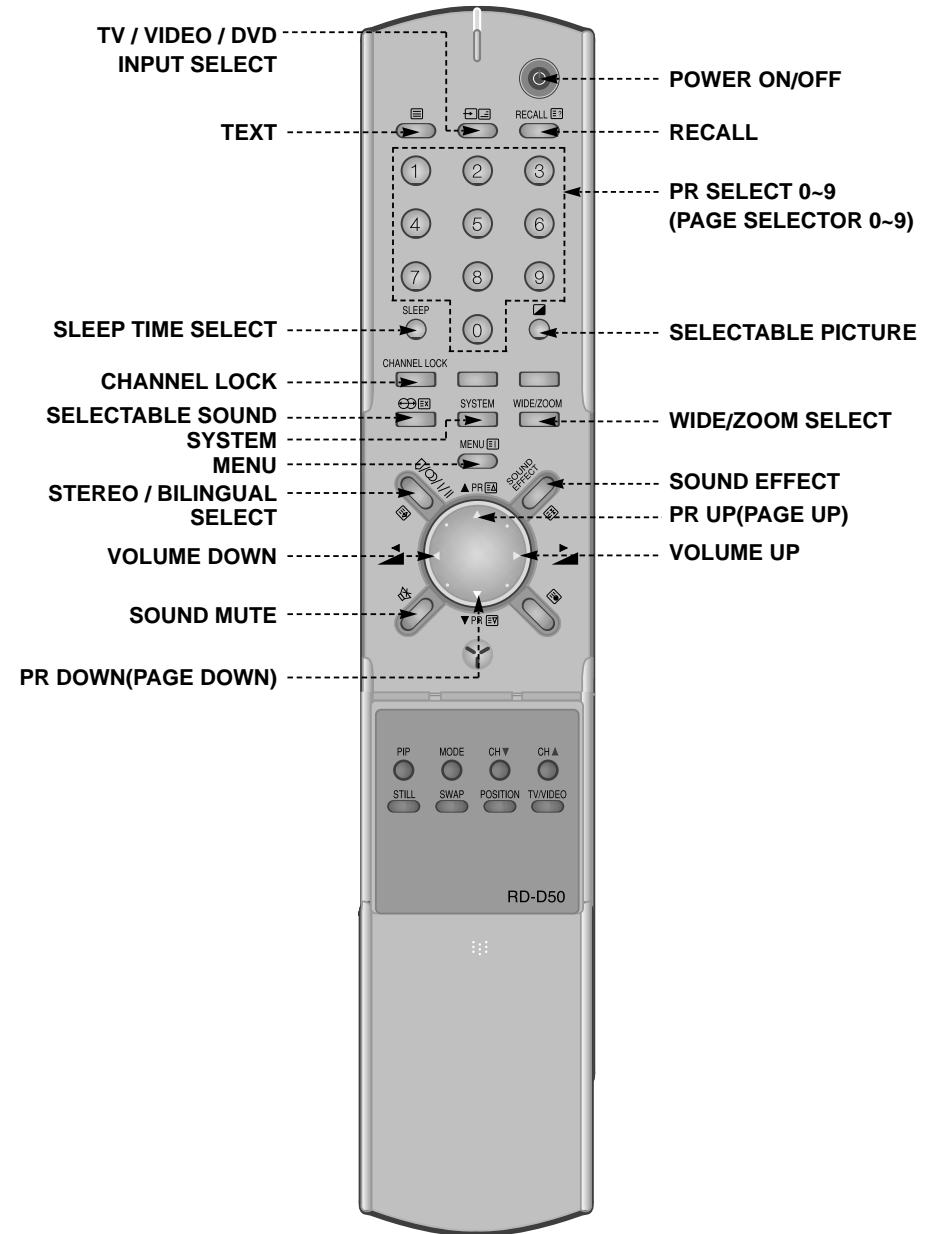

TURNING THE POWER ON/OFF

- The following describes how to turn the TV on/off using the main switch and the remote control.

Turning the power on/off

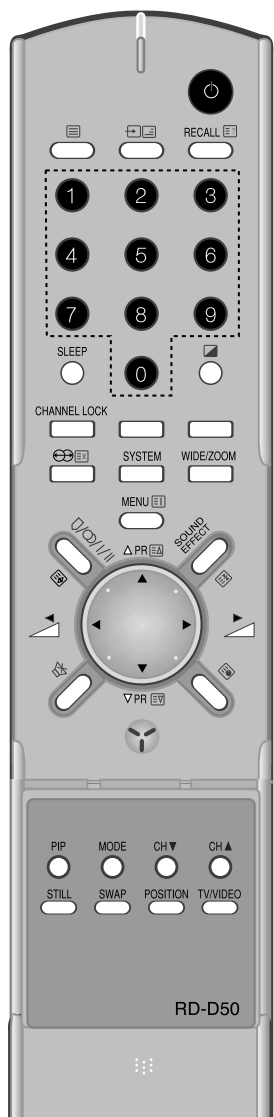

TURNING THE POWER ON/OFF

The following describes how to turn the TV on/off using the main switch and the remote control.

< To turn the power on/off >

- Press the main power switch.
The power indicator lit up red or amber.
It displays the standby mode that the power indicator lit up red.



- If no picture appears, press the "POWER ON/OFF, PR ▼/▲", direct select buttons (0-9)". By pressing the number (one digit only) where the program you want to watch is preset, you can turn on the set program selection at the same time. When the TV is on, the power indicator will lit up amber.

- When the remote control is not at hand, you can turn on the set by pressing the PR ▼/▲ and standby / on buttons on the TV set.

- Adjust the sound volume with the ◀/▶ buttons in receiver or remote control.



- To switch to the standby mode, press the POWER ON/OFF button. At the same time the power indicator is lit up red.

- To turn off completely, press the main power switch. At the same time the power indicator is turned off.

- If you don't use the TV set for a long time, turn off completely by using the main power switch on the TV set. You can decrease unnecessary power consumption.
- When you turn off completely by using the main power switch, Sleep Time and Timer setting are cleared.

AUTO-POWER-OFF

If TV broadcast for a day is finished, the TV will automatically turn off after about 30 minutes. However, if the Off-time or Sleep time is operating, it takes precedence. This Auto-Power-Off feature does not operate in the VIDEO mode.

LAST-MODE-MEMORY

Settings of picture and sound conditions and preset programs are stored in the memory even after turning off the power, therefore, next time the power is turned on, the system will function in the last setting modes.

TUNING THE TV CHANNELS

Auto setup system



AUTO SETUP SYSTEM

- Press the MENU button to select to INSTALL.

- Press the ◀/▶ buttons and then INSTALL SYSTEM.

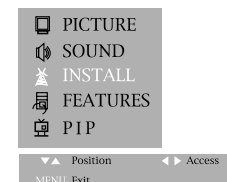

- Select AUTO SETUP with the PR ▼/▲ buttons and the ◀/▶ buttons to start AUTO SETUP.

- NOTE**
Press the ◀/▶ buttons and keep it pressing for 2seconds, the AUTO SETUP will be started.

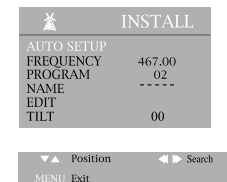

- Please wait until the EDIT menu appears.



- Warning**
This television has been factory pretuned to channels 2, 7, 9, 10 and 28. If the auto search function is activated, these preset channels will be deleted and new channels tuned to 1, 2, 3 ETC..

TILT

When the TILT is selected, the screen will be tilted. If the picture is tilted, please adjust by using following steps.

- Press the MENU button to select INSTALL.

- Press the PR ▼/▲ buttons and then INSTALL SYSTEM.

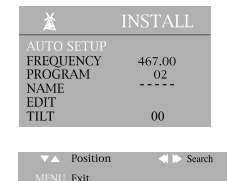

- Select TILT with PR ▼/▲ buttons and ◀/▶ buttons to change the TILT value.



EDIT

1. Press the menu button to select **INSTALL**.
2. Press the **◀/▶** buttons and then **INSTALL SYSTEM**.

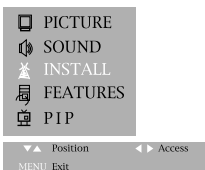

3. Select **EDIT** with the **PR ▼/▲** buttons and press the **◀/▶** buttons to start **EDIT**.



4. **DELETE PROGRAM POSITION DATA.**

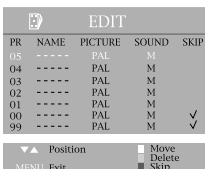

Position the blue-line to the program to delete with the **PR ▼/▲** buttons and the **DELETE** button.

5. **CHANGING THE ORDER OF THE CHANNELS**
Position the blue-line to a program to move with the **PR ▼/▲** buttons and the **move** button.
Press the **PR ▼/▲** buttons to position the blue-line to another program to exchange.
By pressing the **MOVE** button again, selected two program will be exchanged.
6. **ENTER A STATION NAME**
Locate the cursor to below **NAME** with the **◀/▶** buttons.
Using the **PR ▼/▲** buttons, select the desired letter, number or blank.
Press the **▶** (right button) to select the next position.
7. **SELECT THE PICTURE SYSTEM**
Position the blue-line to the **PICTURE** to select with the **◀/▶** buttons and change the picture (ex. PAL, SECAM, NTSC, ..) with the **PR ▼/▲** buttons or you can select the **PICTURE** mode with the **SYSTEM** button on the remote controller.
8. **SELECT THE SOUND SYSTEM**
Position the blue-line to the **SOUND** to select with the **◀/▶** buttons and change the **SOUND** (ex. BG, DK, I, M, ..) with the **PR ▼/▲** buttons.
9. **SKIPPING THE CHANNELS**
You can select **SKIP** with the **SKIP** button in **EDIT** mode or locate in the cursor to below **SKIP** with the **◀/▶** buttons and then press the **PR ▼/▲** buttons to skip the desired program.
A program marked with skip "V" is skipped when changing channel using the program UP/DOWN(on normal operation).
Press the **NUMBER** buttons 0-9 or the **PR ▼/▲** buttons to select program number you want. The screen will change according to the selected program number.

CONVENIENT PICTURE CONTROL

- You can select the picture quality instantly.



TO SELECT THE PICTURE MODE

1. Press the **SELECTABLE PICTURE** () button at remote control to select the desired picture quality.



Normal, Mild and Favourite can be selected cyclically.

2. Or press the **MENU** button to select the **PICTURE** and then to be displayed on the right appearance.
By pressing the **◀/▶** buttons, the following three mode change cyclically.

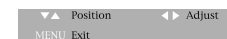

MODE	Picture Quality
NORMAL	hard picture
MILD	soft picture
FAVOURITE	adjustable

3. You can select the **BRIGHTNESS**, **CONTRAST**, **COLOUR**, and **SHARPNESS** with the **PR ▼/▲** buttons.
Select the desired item with the **PR ▼/▲** buttons and press with the **◀/▶** buttons adjust the level.

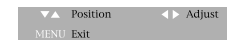

Item	Pressing	
	◀	▶
BRIGHTNESS	darker	lighter
CONTRAST	weaker	stronger
COLOUR	paler	deeper
SHARPNESS	softer	sharper

ENJOYING PANORAMA AND ZOOM PICTURE

- You can enjoy PANORAMA picture and ZOOM 1~ZOOM 4 picture with TV. In addition to regular wide/zoom screen mode.



TO SELECT THE PANORAMA OR ZOOM 1~ZOOM 4 SCREEN

- By pressing the WIDE/ZOOM button in remote control, the following seven modes change cyclically.

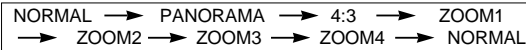

- Or press the MENU button to FEATURES.

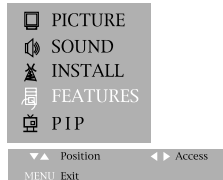

- And then to be displayed on the right appearance. Select the ZOOM with the PR ▼/▲ buttons.

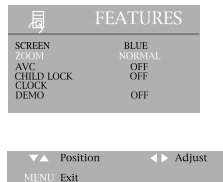

- By pressing the ◀/▶ buttons, the following seven mode change cyclically.

CONVENIENT SOUND CONTROL

- You can select and adjust the sound quality as you like.



TO VOLUME CONTROL

Adjust the volume with the volume Down/Up button on the upper of the set, or with the ◀▶ buttons on the remote control.

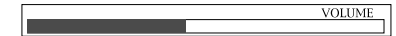

TO MUTE THE SOUND

The muting function is convenient when you need to pay attention to surround sounds, answer a phone call, receive a visitor, etc.

- Press the SOUND MUTE (⊗) button.
- To restore the sound, press the SOUND MUTE (⊗) button again.

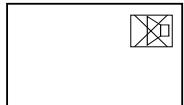

TO DISPLAY THE POSITION NUMBER

Generally, the programme number and stereo or bilingual reception indicator will disappear within 4seconds once the program number has been changed, and the menu display will disappear within few seconds once the menu button has been pressed. To display the position number, press RECALL button and this display will disappear automatically within a few seconds.



TO SELECT THE SOUND MODE

1. Press the SELECTABLE SOUND () button to select the desired sound quality. NORMAL, FAVOURITE, MUSIC, SPEECH can be selected cyclically.



2. Or press the MENU button to select the SOUND and then to be displayed on the right appearance.

Select the PRESET with the PR ▼/▲ buttons.

By pressing the ◀/▶ buttons, the following four mode change cyclically.

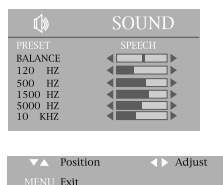

TO ADJUST THE SOUND BALANCE

Press the MENU button to select the SOUND and then to be displayed on right appearance.

Select the BALANCE with the PR ▼/▲ buttons.

Adjust the BALANCE with the ◀/▶ buttons.

Press ◀ button to decrease the right speaker volume and the ▶ button to decrease the left speaker volume.

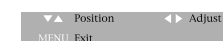
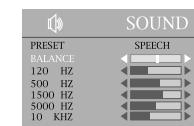

TO ADJUST SOUND FREQUENCY

Press the MENU button to select the SOUND and then to be displayed on the right appearance.

Select the sound frequency(120HZ, 500HZ, 1500HZ, 5000HZ, 10KHZ) with the PR ▼/▲ buttons.

By pressing the ◀/▶ buttons to activate the sound frequency.

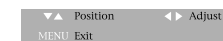
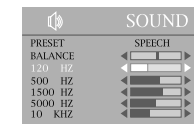

Item	Pressing			
	C		B	
120HZ	Decrease	120HZ	Increase	120HZ
500HZ	Decrease	500HZ	Increase	500HZ
1500HZ	Decrease	1500HZ	Increase	1500HZ
5000HZ	Decrease	5000HZ	Increase	5000HZ
10KHZ	Decrease	10KHZ	Increase	10HZ

TO SELECT SOUND EFFECT

Press the SOUND EFFECT button at remote control to select sound effect.

The display of SURROUND, DYNAMIC, OFF change cyclically whenever you press the SOUND EFFECT button.

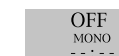

ENJOYING STEREO AND BILINGUAL BROADCASTS

- The unit receives both stereo and bilingual broadcasts transmitted in either the NICAM or German stereo/bilingual broadcasts system.



STEREO PROGRAMS

Press the STEREO/BILINGUAL SELECT (II/III/II) button to select to nicam-stereo/mono mode.

PRO8 -----
MONO

BILINGUAL PROGRAMS

1. When a bilingual program is received DUAL 1, DUAL 2 appears.

PRO8 -----
DUAL 1

2. Press the STEREO/BILINGUAL SELECT button to be heard. The sound differs according to transmission system : DUAL 1 and DUAL 2 appear cyclically on the screen.

	Sound to be heard	
	NICAM	German stereo
DUAL 1	Main sound	Main sound
DUAL 2	Sub sound	Sub sound

USING OTHER MENUS



TO SET CLOCK

1. Press the MENU button to select the FEATURES and then to be displayed on the right appearance.

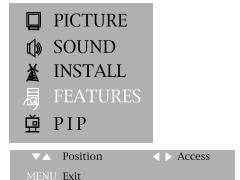

2. Select the CLOCK with PR ▼/▲ buttons.

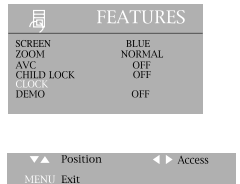

3. Press the ◀/▶ buttons to activate the hour or the minute and preset the hour or minute with the direct(0-9) buttons.

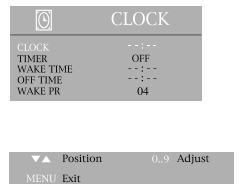



TO TURN ON THE TV AUTOMATICALLY(WAKE TIME)

With the CLOCK, the WAKE TIME, the WAKE PR.

Preset, the TV will automatically turn on to a preset program number at a reset time.

Set the timer ON.

Select the WAKE TIME with PR ▼/▲ buttons.

Then, press direct key(0-9) to set the wake up time.

CLOCK	
CLOCK	10:00
TIMER	ON
WAKE TIME	08:00
OFF TIME	21:00
WAKE PR	01

▼▲ Position	◀▶ Adjust
MENU Exit	0-9 Adjust

TO TURN OFF THE TV AUTOMATIC(OFF TIME)

With the CLOCK and the OFF TIME preset, the TV will automatically switch to stand-by mode at a preset time.

Set the timer ON.

Select the OFF time using PR ▼/▲ buttons and then press direct key (0-9) to set the OFF TIME.

CLOCK	
CLOCK	10:00
TIMER	ON
WAKE TIME	08:00
OFF TIME	21:00
WAKE PR	01

▼▲ Position	0-9 Adjust
MENU Exit	



SLEEP TIME SETTING

1. When this button, up to 2 hours every 20 minutes can be set to the sleep timer.

PRO4	-----
MONO	
SLEEP	20

2. If you press the SLEEP button for the first time, SLEEP 0 sign of the non set sleep-timer appears on the upper left side of the screen.
3. When this button pressed again, 20 minute are set to the sleep-timer.
4. This display disappears within 4 seconds unless any button is pressed. Whenever pressed again, the setting time is increased by 20 minute.

(SLEEP 0 → SLEEP 20 → SLEEP 40 → SLEEP 60 → SLEEP 80 → SLEEP 100 → SLEEP 120)

5. If this button is pressed again, during the sleep-timer operation, the remaining time of the sleep-timer appears on the screen.
6. In addition, if this button is pressed repeatedly, the setting time is increased by 20 minute continuously.
7. When the remaining time become "0", the TV receiver is turn off automatically.



TO SELECT THE SCREEN COLOR

When no signal is being received, the TV will automatically turn blue or red at the time SCREEN BLUE or SCREEN RED on.

FEATURES	
SCREEN ZOOM	BLUE NORMAL
AVC	OFF
CHILD LOCK	OFF
CLOCK	OFF
DEMO	OFF

1. Press the MENU button to select the FEATURES and then to be displayed on the right appearance. Press PR ▼/▲ buttons to select the SCREEN.

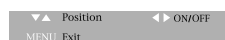

2. Press the ◀/▶ buttons to change OFF, BLUE and RED.

TO SELECT DEMO

Demo function shows all current configured OSD menu one by one.

FEATURES	
SCREEN ZOOM	BLUE NORMAL
AVC	OFF
CHILD LOCK	OFF
CLOCK	OFF
DEMO	OFF

1. Press the MENU button to select the FEATURES.
2. Select the DEMO with the PR ▼/▲ buttons.
3. Press the ◀/▶ buttons, the demo function is started.
4. If you want to be out of demo function, press the MENU button.

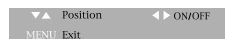

TO SELECT THE AUTO VOLUME CONTROL

Different sound source (eg. Advertisement during movies) fairly often do not have the same volume level.

In the case, you can equalize the volume with the AVC(auto volume control) ON.

FEATURES	
SCREEN ZOOM	BLUE NORMAL
AVC	OFF
CHILD LOCK	OFF
CLOCK	OFF
DEMO	OFF

1. Press the MENU button to select the FEATURES and then to be displayed on the right appearance.

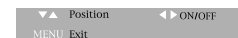

2. Press the PR ▼/▲ buttons to select the AVC(auto volume control).

3. Press the ◀/▶ buttons to change AVC (auto volume control) ON.

* NOTE

With the AVC(auto volume control) ON, the maximum volume level can be down. You can maximize the volume level with the AVC(auto volume control) OFF.

TO SELECT CHANNEL LOCK

1. You can prevent the watching of some channel without the remote controller.

2. Keep on pressing CHANNEL LOCK button until it displays : "LOCK ON".

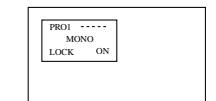

3. The TV can be switched back on only using the remote controller.

4. If you want to watch this channel, you must select CHANNEL LOCK OFF.

TO SELECT CHILD LOCK

1. You can prevent the use of the TV set without the remote control.

Press the MENU button to select the FEATURES and press the PR ▼/▲ buttons to select the CHILD LOCK.

FEATURES	
SCREEN ZOOM	BLUE NORMAL
AVC	OFF
CHILD LOCK	OFF
CLOCK	OFF
DEMO	OFF

2. Press the ◀/▶ buttons to change CHILD LOCK ON. Then the program will be locked.

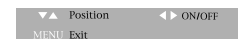

3. Press the "POWER" button in the remote control to be at stand by mode.

4. The TV can be turn on only using the remote controller.

WATCHING PICTURE IN PICTURE

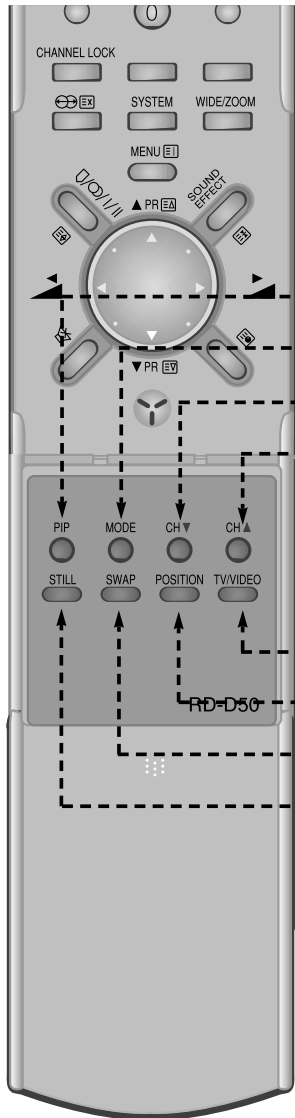

The unit is capable of displaying two picture with the small sub picture simultaneously. This is called the Picture-In-Picture function. A TV picture or a picture from external source equipment such as a VTR can be displayed as another picture.

PIP

MODE

SUB CH DOWN

SUB CH UP

SUB TV/VIDEO

SUB POSITION

SWAP

STILL



TO WATCH A TV OR AN EXTERNAL SOURCE AS A SUB-PICTURE

1. Select the desired program.
2. Press the PIP button to display a sub-picture.
3. Press the sub TV/VIDEO button repeatedly to select the input for the sub picture(the small picture). A TV picture, the picture from the TV, AV1, AV2, AV3 will appear cyclically.
4. When a TV picture appears, select the desired TV program using the CH ∇/\blacktriangle buttons. Press the CH ∇/\blacktriangle buttons to select lower program numbers and CH ∇/\blacktriangle buttons to select higher ones.
5. To turn off the sub-picture, press the PIP button again.

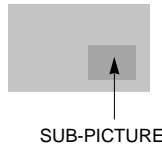

6. Or press the MENU button to select the PIP and then to be displayed on the right appearance. Select the PIP with the PR ∇/\blacktriangle buttons. Press the $\blacktriangle/\blacktriangleleft$ buttons to select the PIP ON(or OFF).



7. Select SELECT with the PR ∇/\blacktriangle buttons. Press the $\blacktriangle/\blacktriangleleft$ buttons to select the input the sub-picture(the small picture). A TV picture, the picture from the TV, AV1, AV2, AV3 will appear cyclically.
8. When a TV picture appears, select the Pr with the PR ∇/\blacktriangle buttons. Select the desired TV program using the $\blacktriangle/\blacktriangleleft$ buttons. Press the \blacktriangleleft button to select lower program buttons. Press the \blacktriangleright button to select higher ones.

9. Select MODE with the PR ∇/\blacktriangle buttons. Press the $\blacktriangle/\blacktriangleleft$ buttons to select the mode(LARGE, SMALL, 3PIC, 9PIC, 12PIC, 2PIC). The mode will be appear cyclically.

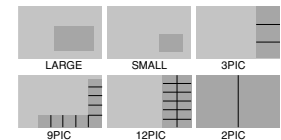

- When SUB-PICTURE mode, you can't select DVD.



TO SWITCH THE MAIN AND SUB-PICTURE OF THE PIP

Press the SWAP button when a picture-in-picture is displayed. The main picture (the large picture) and sub-picture (the small picture) are switched.

Press the SWAP button again to switch again.

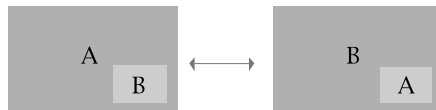

TO FREEZE THE SUB-PICTURE

Press the STILL button when a sub-picture is displayed. The sub-picture will be a still picture. To return to a moving picture, Press the STILL button again.

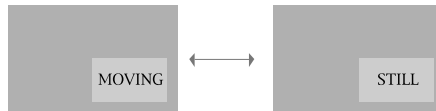

TO CHANGE THE POSITION OF THE SUB PICTURE (WHEN SMALL or LARGE MODE)

Press the position button repeatedly when a sub-picture is displayed. The display position of the sub-picture will change in order ① to ④ PIP mode.

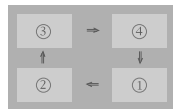

CONNECTING OTHER MACHINES LIKE VIDEO

- When connecting other equipment, please ensure you turn the main switch OFF to prevent any damage to the equipment.

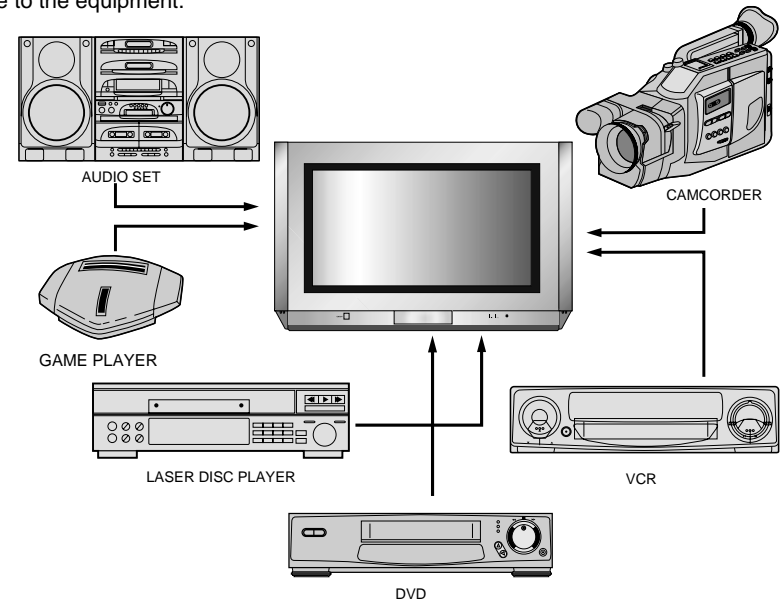

NAMES AND FUNCTIONS OF CONNECTIVE TERMINALS

- When connecting other equipment, please ensure you turn the main switch OFF to prevent any damage to the equipment.

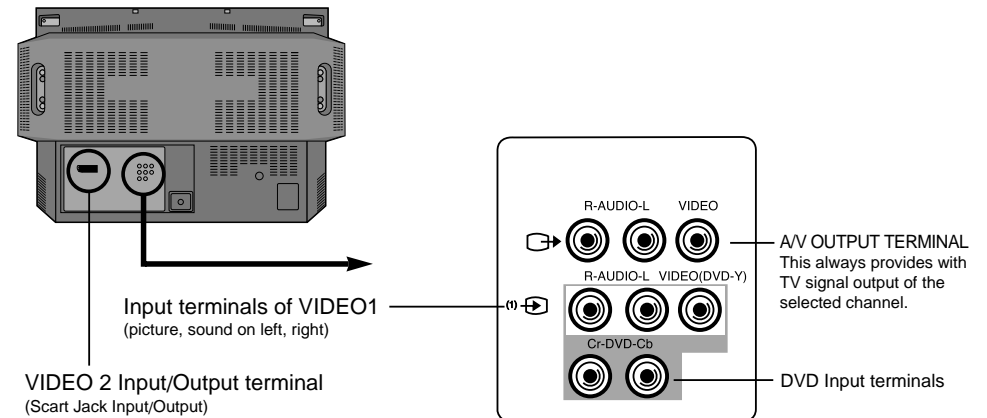

CONNECTING VIDEO

- When connecting other equipment, please ensure you turn the main switch OFF to prevent any damage to the equipment.

When connecting the VIDEO to the back of the TV

- Prepare the connective plug for picture/sound.
- Connect the VIDEO picture output terminal with the TV picture input terminal.
- Connect the VIDEO sound output terminal with the TV sound input terminal.
- Press the TV/VIDEO/DVD() button on the Remote control and select AV1.

- Both VIDEO1 and VIDEO2 are OK.

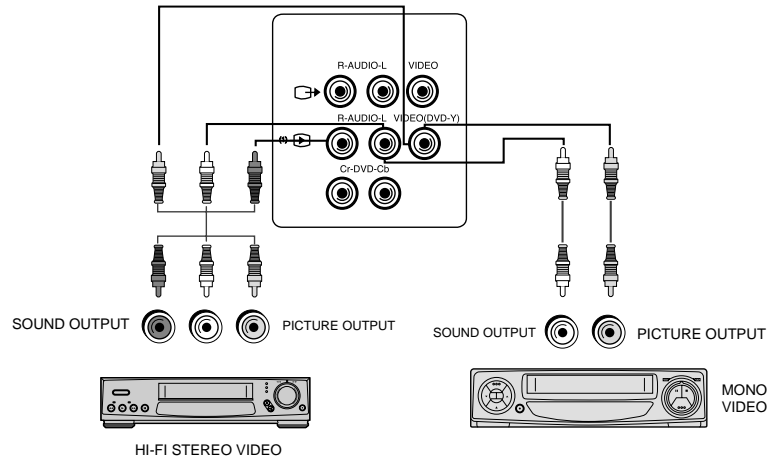

- In case of mono VIDEO, connect the VIDEO sound output terminal with right or left sound input one of TV.

Side Connector

- The connection method is as same as back.
- In front connector, it's better to connect the materials which are unusually used such like camcorder, game player, etc.
- Press the TV/VIDEO/DVD() button on the Remote Control, and select AV3.

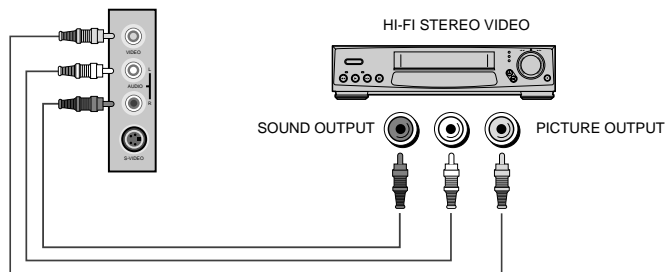

CONNECTING AT AV2(SCART)



- When connecting other equipment, please ensure you turn the main switch OFF to prevent any damage to the equipment.

Connecting to a HI-FI STEREO VIDEO(STEREO mode is defaulted)

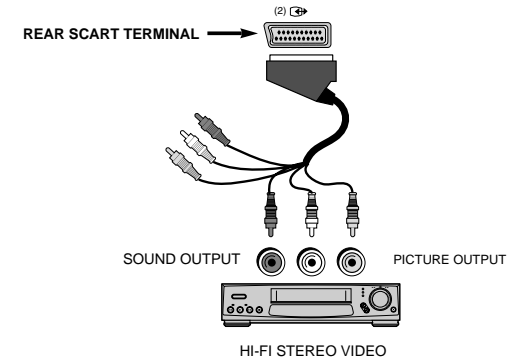
- Prepare the connective plug for picture/sound.
- Connect the VIDEO input/output terminal with the VIDEO2(AV2) terminal.
- Press the TV/VIDEO/DVD() button on the Remote control and select AV2.
- Select the STEREO mode with the STEREO/BILINGUAL SELECT button.



Connecting to a MONO VIDEO(STEREO mode is defaulted)

- Use a two wire RCA cable to make a connection with a MONO VIDEO.
- Keep on pressing ( /  / ) button to change from STEREO, L-INPUT, R-INPUT.
 - STEREO : The sound will only come from one speaker.
 - L-INPUT : The sound will come from both speaker.
 - R-INPUT : The sound will not come at all.
- If R-INPUT of the TV is connected to the audio out of VIDEO, the mode will be
 - STEREO : The sound will only come from one speaker.
 - L-INPUT : The sound will not come at all.
 - R-INPUT : The sound will come from both speaker.

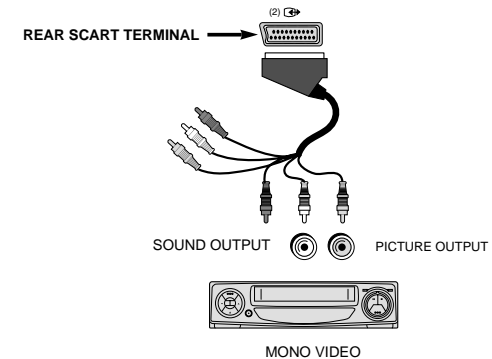

■ Connecting SCART to SCART(STEREO mode is defaulted)

1. Prepare the connective plug for picture/sound.
2. Connect the SCART input/output terminal of VIDEO with the SCART input/output terminal of TV.

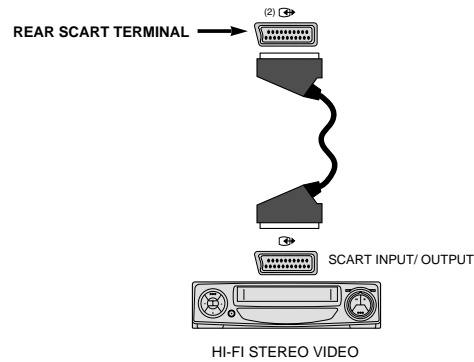



CONNECTING WITH S PICTURE VIDEO

- When connecting other equipment, please ensure you turn the main switch OFF to prevent any damage to the equipment.

■ Side Connector

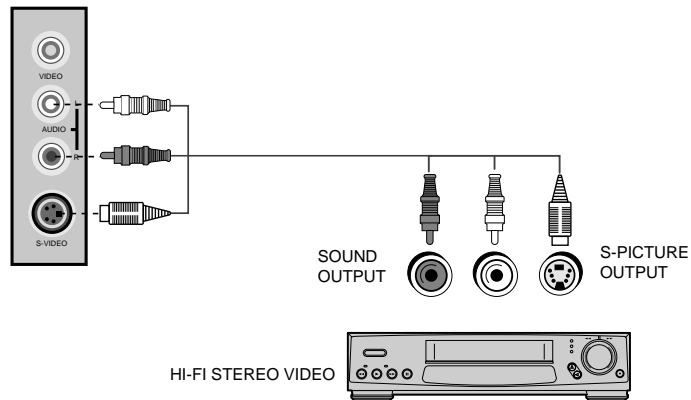
- To watch TV in clear field by inputting S picture.
When repeating high-quality field VIDEO, you can enjoy clear and sharp picture by connecting it with TV S-VHS terminal.



1. Connect S-VHS connective plug with S-VHS output terminal of VIDEO set and S-VIDEO picture input terminal of TV set.
2. Connect sound connective plug with sound output terminal of VIDEO set and sound input terminal of TV set.
3. Press the TV/VIDEO/DVD() button on the Remote control, and select VIDEO 3(AV3).

CONNECTING WITH VIDEO CAMERA(CAMCORDER)

- When connecting other equipment, please ensure you turn the main switch OFF to prevent any damage to the equipment.

■ To connect VIDEO CAMERA with the TV

- When watching a recording by VIDEO CAMERA, it's convenient to connect with the TV front connector.

1. Prepare the connective plug of picture/sound.
2. Connect the picture/sound connective terminal to VIDEO CAMERA picture/sound output terminal and the TV front picture/sound input one.
3. Press the TV/VIDEO/DVD() button on the Remote control, and select AV3.
4. Set the transfer switch of VIDEO CAMERA picture in/output, then replay the VIDEO CAMERA.

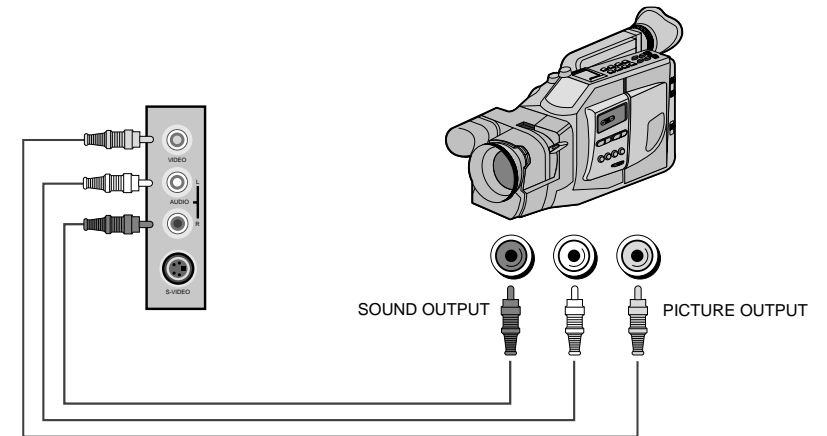

CONNECTING WITH AUDIO SET

- When connecting other equipment, please ensure you turn the main switch OFF to prevent any damage to the equipment.

- When listening to sound in powerful AUDIO, while watching the picture on TV.
- Connect external input terminal of AUDIO to right & left sound output of TV signal.

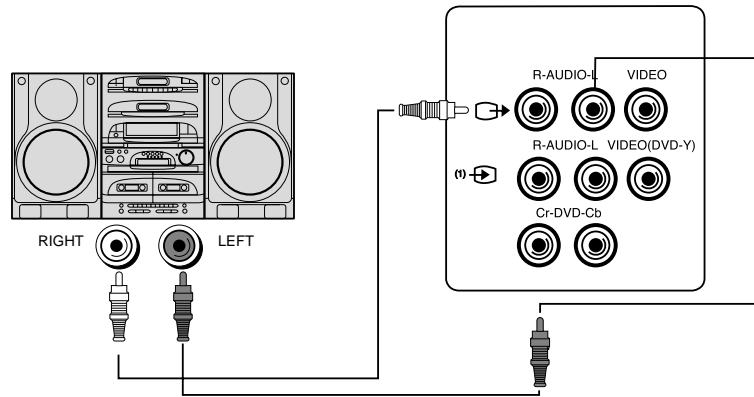

CONNECTING DVD PLAYER

- When connecting other equipment, please ensure you turn the main switch OFF to prevent any damage to the equipment.

- When connecting the DVD player.

1. Prepare the connective plug for picture/sound.
2. Connect the DVD-Y output terminal of DVD player with the DVD-Y input terminal of TV.
3. Connect the Cr-DVD-Cb output terminal of DVD player with the Cr-DVD-Cb input terminal of TV.
4. Press the TV/VIDEO/DVD() button on the Remote Control to turn the TV into the DVD.

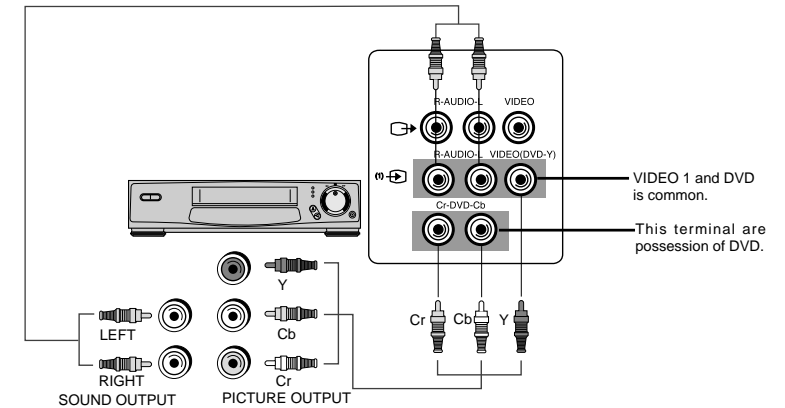

- You can connect the DVD PLAYER with VIDEO 1 INPUT TERMINALS, VIDEO3 INPUT TERMINALS or SCART JACK(VIDEO2) input/output terminal.

BROADCAST TRANSMISSION SYSTEMS IN EACH COUNTRY

Broadcast Transmission Systems in Each Country

Area	Country	System	
		Color	Sound
Asia M. E.	Bahrain, Kuwait, Israel, Oman, Qatar, United Arab Emirates, Yemen, etc. India, Indonesia, Malaysia, Singapore, Thailand, etc.	PAL	B/G
	China, etc.	PAL	D/K
	Hong Kong	PAL	I
	Iraq, Islamic Republic of Iran, Lebanon, Saudi Arabia, etc.	SECAM	B/G
	Russian Federation, etc. Myanmar, etc.	SECAM NTSC	D/K M
Oceania	Australia	PAL	B/G(H)

VIEWING TELETEXT(OPTION) / USE OF THE TELETEXT BUTTONS

- The teletext service is carried on a TV transmission signal, therefore it is only available when a TV program can be received on your TV.
Your choice of TV program also governs which Teletext service you will receive.

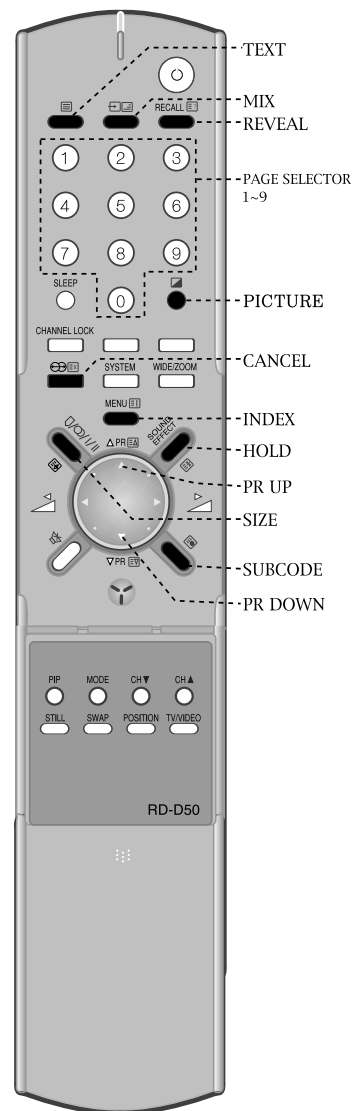

TO SELECT THE TEXT MODE

First, turn on your TV SET and choose your TV program.
Then press the TEXT() button to switch the receiver to Teletext mode.
To select any other page, simply press the three of the PAGE SELECTOR buttons or PR ∇/\blacktriangle buttons. The page number requested is displayed on the upper left hand side of the screen.
To return to normal TV operation, the TEXT() button is pressed.

Note that if the new page requested is a news flash or a subtitle page, the normal TV picture is automatically turned on and the news flash or subtitle displayed in a box within the picture.

SPLIT SCREEN

In Teletext mode, press the TEXT() button to select the SPLIT SCREEN mode and then to be displayed split screen.

PAGE SELECT

In Teletext mode, the PAGE SELECTOR buttons are used to enter a page number or a subcode.
During digit entry page, acquisition is stopped.
Or PR ∇/\blacktriangle buttons decrease or increase the current page number by 1.

INDEX

When the INDEX() button is pressed in the FLOF mode, the Teletext decoder is set up to display the index page.
Press once for Main Index Page : press again for full index.
When the TV is in LIST mode, the teletext decoder is set up to display the Red Bank.

MIX

In normal Teletext mode, TV picture and character data are not displayed simultaneously.
The MIX() button allows a combined display of TV picture and character data.

PICTURE

In Teletext mode, if you press the PICTURE() button, you can control brightness by pressing $\blacktriangle/\blacktriangleright$ buttons.

SIZE

By pressing the SIZE button, either the top half or the bottom half of the Text display can be expanded.
Press the SIZE() button once and the top half of the display expanded.
Press again and the bottom half is expanded.
Press again and the display return to normal size characters.

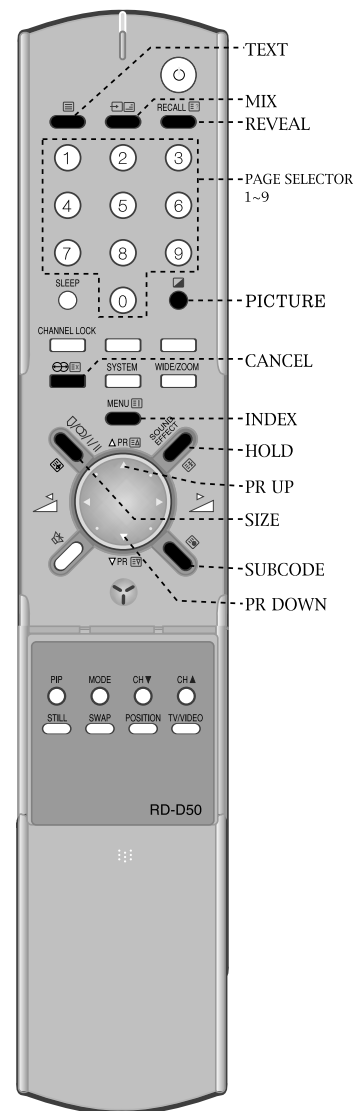

REVEAL

Some Teletext pages play a role in concealing part of the display in, for example, a quiz page with concealed answer.
The REVEAL() button releases the concealed text as long as the REVEAL() button is not again.

HOLD

Some Teletext pages contain more information than can be displayed simultaneously and are therefore sub-divided into a series of two or more pages.
The first sub-page of a series of four sub-pages will. For example, be indicated by a 1/4 displayed on the top right hand side of the next page. These sub-pages are automatically rotated, each page being displayed for a set time before being replaced by the next page. If you need to read a certain page for longer than allowed, or retain a particular sub-page, then the HOLD() button should be pressed.
The HOLD() symbol will be displayed on the top left hand side instead of the page number and page acquisition will be stopped.
Normal operation is restored by pressing the HOLD() button again or by entering a new page number.

CANCEL

The CANCEL() button suppresses the Text display and restores the normal TV picture while the receiver remain in the Teletext mode.
This function allows you to request Teletext page and after Teletext controls without interrupting a TV program.
To return to normal TV operation, the CANCEL() button is pressed again.

SUBCODE

For Teletext information which is longer than one page, it may take some time for the automatically changing of sub-pages to reach the sub-page you require.
It is possible, however, to enter the sub-page you require and continue watching a normal TV program until the correct sub-page has been reached.
Press SUBCODE() button, the character S---- will appear in the left side, while character --:- will appear on the right. Enter the desired sub page number. EG. To select sub page 10, press 0,0,1,0.
Press CANCEL() button to return to normal TV program. When the requested sub-page is reached, the main page number will be superimposed on the normal TV picture. Press the Teletext() button to display the stored sub-page.

SPECIFICATION

MODEL		PF32W503
TV Standard	Color system	PAL/SECAM, NTSC 3.58/4.43(AV)
	Sound system	B/G, D/K, I, H
Rated voltage		110-240V~, 50/60Hz
Power consumption		148W
Sound Output Power		8W X 8W
Channel Coverage		HYPER BAND CATV VHF L : E2(48.25MHz)~S6(147.25MHz) VHF H : S7(147.25MHz)~S36(423.25MHz) UHF : S37(431.25MHz)~E69(855.25MHz)
Tuning System		Frequency Synthesizer Tuning System
Program No. Indication		ON-Screen Display
Program Selection		100 Programs
Aux. Terminal		A/V INPUT 1, 2 (SCART), 3, DVD A/V OUTPUT 1 (RCA) [TV Signal] A/V OUTPUT 2 (SCART) [TV Signal]
Remote Control Unit.		RD-D50(Required two 1.5V batteries type with AA size)
Dimension		890(W) x 580(H) x 564(D) mm
Weight		57kg
Picture tube		32" REAL FLAT TYPE

NEC Service Centres

NEC

NEC Australia Pty. Ltd.
ABN 86 001 217 527
Home Electronics Group

NEC Service centres

PH: 131-632

NEW South Wales

Sydney 184 Milperra Rd, Revesby 2212 (02)9780 8688
 Newcastle 120 Parry Street, Newcastle 2302 (02)4926 2466

Victoria

Melbourne Unit 1/6 Garden Road, Clayton 3168 (03)8562 6245

Queensland

Brisbane Unit 4/305 Montague Road, WEST END 4101 (07)3840 5858
 Southport Shop 1, 48 Ferry Rd, Southport 4215 (07)5591 3670

South Australia

Adelaide 84A Richmond Rd, Keswick, 5053 (08)8375 5710

Western Australia

Perth 45 Sarich Court, Osborne Park 6017 (08)9445 5901

For Service in outer areas, please contact your NEC retailer for the address of the nearest Authorised NEC Service centre.

NEC Australia Pty. Ltd.
Home Electronics Group
244 Beecroft Road EPPING 2121
Tel: 131 632
Fax: (02)9877 2353