

21" FLAT SCREEN CRT / DVR OBSERVATION SYSTEM WITH 4 NIGHT VISION CAMERAS

Instruction Manual

English Version1.0



**MODEL:
SG21FD3044-161**



www.lorexcctv.com

Copyright © 2006 Lorex Technology Inc.

Thank you for purchasing the 21" Flat Screen CRT / DVR Combo. This unique and innovative system provides a complete security package, combining a commercial grade 4 channel Digital Video Recorder (DVR) with a 21" Flat screen CRT monitor.

To learn more about this 21" Flat screen CRT / DVR Combo Observation system and about our complete range of accessory products, please visit our website at:

www.lorexcctv.com

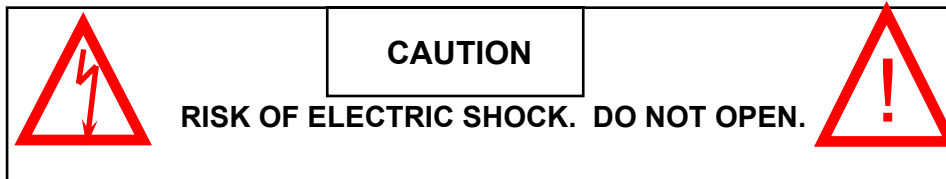

CAUTION! TO REDUCE THE RISK OF ELECTRIC SHOCK, DO NOT REMOVE COVER (OR BACK). NO USER-SERVICEABLE PARTS INSIDE. REFER SERVICING TO QUALIFIED SERVICE PERSONNEL.

Explanation of two Symbols

The lightning flash with arrowhead symbol, within an equilateral triangle, is intended to alert the user to the presence of un-insulated "dangerous voltage" within the product's enclosure that may be of sufficient magnitude to constitute a risk of electric shock to persons.



The exclamation point within an equilateral triangle is intended to alert the user to the presence of important operating and maintenance (servicing) instructions in the literature accompanying the appliance.



THE GRAPHIC SYMBOLS WITH SUPPLEMENTAL MARKING ARE ON THE BOTTOM OF THE SYSTEM.

"WARNING – TO PREVENT FIRE OR SHOCK HAZARD, DO NOT EXPOSE THE UNIT TO RAIN OR MOISTURE"

NOTE:

This equipment has been certified and found to comply with the limits regulated by FCC, EMC and LVD. Therefore, it is designed to provide reasonable protection against interference and will not cause interference with other appliance usage.

However, it is imperative that user follows this manual's guidelines to avoid improper usage which may result in damage to the unit, electrical shock and fire hazard or injury.

In order to improve the feature functions and quality of this product, the specifications are subject to change without notice from time to time.

FCC CLASS B NOTICE**NOTE :**

This equipment has been tested and found to comply with the limits for a Class B digital device, pursuant to Part 15 of the FCC Rules. These limits are designed to provide reasonable protection against harmful interference in a residential installation. This equipment generates, uses and can radiate radio frequency energy and, if not installed and used in accordance with the instruction, may cause harmful interference to radio communications. However, there is no guarantee that interference will not occur in a particular installation. If this equipment does cause harmful interference to radio or television reception, (which can be determined by turning the equipment off and on), the user is encouraged to try to correct the interference by one or more of the following measures:

Increase the separation between the equipment and the camera and/or monitor.

Connect the equipment into an outlet on a circuit different from that to which the other electrical devices are connected.

Consult the dealer or an experienced radio or television technician for help.

LOREX TECHNOLOGY INC**www.lorexcctv.com**

CONTENTS

1	GENERAL PRECAUTIONS	1
2	CAUTIONS AND FEATURES	2
2.1	FEATURES	2
2.2	CAUTIONS	3
2.3	NETVIEWER SOFTWARE INSTALLATION	3
3	SYSTEM INCLUDES	4
4	GETTING STARTED.....	5
5	DESCRIPTION OF PARTS AND FUNCTION – FRONT PANEL	7
6	DESCRIPTION OF PARTS AND FUNCTION – BACK PANEL	12
7	MAIN MENU CONTROL	13
7.1	TIME / DATE SET	15
7.2	SEQUENCE SET	15
7.3	TITLE SET	15
7.4	ALARM SET	15
7.5	MOTION SET	16
7.6	SYSTEM SET (I)	16
7.7	SYSTEM SET (II)	17
7.8	HDD / REC SET	17
7.9	ALARM REC SET	18
7.10	SCHEDULE REC SET -	18
7.11	MONITOR SET	19
7.12	FIRMWARE UPGRADE	19
7.13	DDNS SET	19
7.14	EXIT	20
8	PLAYBACK SEARCH	21
9	PLAYBACK OPTION.....	22
9.1	FAST REWIND AND FAST FORWARD	22
9.2	JOG-SHUTTLE FUNCTION	22
9.3	MULTIPLEXING FUNCTION IN PLAYBACK	22
10	PAN/TILT ZOOM.....	23
11	REMOTE CONTROL	24
12	CAMERA (DIN Connector) INSTALLATION	25
13	CAMERA (BNC Connection) INSTALLATION	26
14	MONITOR AND STANDARD VCR INSTALLATION.....	27
15	ETHERNET (NETWORK), EXTERNAL ALARM DEVICE INSTALLATION	28
16	NETWORK IMAGE SIZE AND SPEED.....	29

17	RECORDING TIME (IN HOURS).....	30
18	RECORDING TIME (IN GIGABYTES PER HOUR).....	31
19	INSTALLING THE HDD	32
20	TECHNICAL SPECIFICATIONS	35
21	TROUBLESHOOTING	36
22	CARE AND MAINTENANCE.....	37

1 GENERAL PRECAUTIONS

1. Read Instructions: All of the safety and operating instructions should be read and understood before the product is used.

2. Retain Instructions: The safety and operating instructions should be retained for future reference.

3. Heed Warnings: All warnings on the product and the instruction manual should be followed.

4. Follow Instructions: All operating and use instructions should be followed for optimal performance

5. Cleaning: Disconnect this video product from the power supply before cleaning. Do not use liquid cleaners or aerosol cleaners. Use a damp cloth for cleaning.

6. Attachments: Do not use attachments not recommended by the video product manufacturer as they may cause hazards.

7. Water and Moisture: Do not use this product near water - for example, near a bathtub, wash bowl, kitchen sink, wet basement, or near a swimming pool.

8. Accessories: Use this product only with a stand, tripod, bracket or table recommended by the manufacturer or sold with the product. Any mounting of the product should follow the manufacturer's instructions.

9. Ventilation: This product should never be placed near or over a Radiator or heat register. This product should not be placed in a built-in installation, such as a book case or rack, unless proper ventilation is provided or the Manufacturer's instructions have been adhered to.

10. Power Source: This product should be operated from the type of Power source indicated by the marking label. If you are not sure of the type of power supply provided to your location, consult your product dealer or your local Power Company.

11. Power Cord Protection: Power supply cords should not be routed so that they are likely to be walked on or pinched by items placed on or near them

12. Lightning: For added protection, unplug this product from its outlet during a lightning storm. This will prevent damage to the video product due to lightning and power surges.

13. Overloading: To avoid the risk of fire and electric shock, do not plug this product into an over-loaded power supply.

14. Object and Liquid Entry: Never push objects into the openings of this product as they may touch dangerous voltage points that may result in fire or electric shock. Never spill a liquid of any kind on this product.

15. Servicing: Do not attempt to service this product yourself as opening or removing covers may expose you to voltage or other hazards. Refer all servicing to qualified service personnel

16. Damage Requiring Service: Disconnect this product from the power supply and refer servicing to qualified service personnel under the following conditions:

- a. When the power supply cord or plug is damaged
- b. If objects have fallen into the product
- c. If the product has been exposed to rain or liquids
- d. If the product does not operate normally by following the instruction manual. Adjust only the controls that are covered in the instruction manual as an improper adjustment may result in damage and will often require extensive work by a qualified service technician to restore the product to its normal operation
- e. If the product has been dropped or the cabinet has been damaged
- f. When the product displays a distinct change in performance - this indicates a need for service

17. Replacement Parts: When replacement parts are required, be sure the technician uses replacement parts specified by the manufacturer. Unauthorized substitutions may result in fire, electric shock, or other hazards.

18. Safety Check: Upon completion of any service to this product ask the service technician to perform safety checks to determine that the product is in proper working condition.

19. Grounding or Polarization: This product is equipped with a three-wire grounding-type plug, a plug having a third (grounding) pin and will only fit into a grounding-type power outlet. This is a safety feature. If you are unable to insert the plug into the outlet, contact your electrician to replace your obsolete outlet. Do not defeat the safety purpose of the grounding-type plug.

20. Power Lines: An outside antenna system should not be located in the vicinity of overhead power lines or other electric light or power circuits, or where it can fall into such power lines or circuits. When installing an outside antenna system, extreme care should be taken to keep from touching such power lines or circuits as contact with them might be fatal.

21. Wall or Ceiling Mounting: The product should be mounted to a wall or ceiling only as recommended by the manufacturer.

22. Heat: The product should be situated away from heat such as radiators, hear registers, stoves, or other products (including amplifiers) that produce heat.

2 CAUTIONS & FEATURES:

2.1 FEATURES

MONITOR

- Picture Tube: 21" Flat Color CRT
- Horizontal Resolution: More than 480 Lines
- Camera capable: 8 (DIN / BNC) (dual quad)
- Audio inputs: 8 RCA
- Alarm Inputs/Outputs: 8/1
- Slave output A/V: Video: RCA, Audio: RCA Jack
- Input signal: 1 V p-p at 75 ohms terminated Power source: Multi-voltage (100-240 VAC)
- Power Consumption: 125 watts (Max)
- Operation Temperature: 0°C - 40°C (32°F to 104°F)
- Weight: 57 lbs (26 Kg)
- Color: Grey

DVR

- Operation System: Embedded Linux
- Recording frame(FPS): 60
- Resolution recording: 720 X 240
- Audio recording: Yes
- Jog/Shuttle: Yes
- Triplex: Yes
- Pan/Tilt/Zoom Support: YES
- Network: RJ-45(10/100BASE-T)
- Pre alarm: Yes
- Water marking: Yes
- Video motion det: Yes
- USB port for USB key mem: Yes
- Compression video: M-JPEG(CCIR 656 FORMAT)
- Compression audio: MPEG1
- Compression rate: 5~20 Kbyte/Field
- Resolution display: Full Screen: 720x480 QUAD: 360x240
- Recording speed NTSC: 60/30/15/10/5/2/1
- FPS Recording mode: NORM, ALARM, SCHEDULE
- Event list: 3,000 LIST
- Search F.F: X1 , X2 , X4 , X8 , X16
- Search REW: X1 , X2 , X4 , X8 , X16
- Remote Control Yes
- HDD max Capacity: 400GB (160GB included)

CAMERAS

- Image Sensor 1/4" Interline transfer type color CCD
- Effective Pixels (NTSC) 510H x 492V (250K)
- Scanning System (NTSC) 525 Lines 2:1 Interlace
- Scanning Frequency (NTSC) 15.734KHz (H), 59.94Hz (V)
- Resolution Horizontal 350 TV lines
- Shutter Speed (NTSC) 1/60 ~ 1/10,000 sec.
- S/N Ratio More than 48dB (AGC off)
- Sync. System Internal
- Min. Illumination 1.0 Lux (without LED) / 0.1 Lux (with LED)
- White Balance AWB
- Video Output VBS 1.0 Vp-p @ 75ohm
- Lens Fixed Lens (6mm)
- Power Consumption 100mA (without LED) / 180mA (with LED)
- Operating Temp 14F to 113F (-10°C ~ +45°C)
- Weather Proof Rating IP65
- Operating Humidity 90% RH max.

2.2 CAUTIONS

- 1 All the warnings and instructions of this manual should be followed
- 2 Remove the plug from the outlet before cleaning. Do not use liquid aerosol detergents. Use water damped cloth for cleaning
- 3 Do not use this unit in very humid and wet places
- 4 Keep enough space around the unit for ventilation. Slots and openings of the cabinet should not be blocked.
- 5 During flashes of lightning or cracks of thunder, or when the system is not used for a long time, unplug the system power supply and disconnect the antenna and cables to protect the unit from lightening or power surges.

2.3 NetViewer Software Installation Requirements

Minimum System Requirements:

Operating System:	Windows 2000 Windows XP Home Edition / Windows XP Professional
Processor:	Pentium 4 – 1.5 GHz Processor (or equivalent)
Memory:	256MB RAM
Hard Drive:	50 MB Installation space * Additional Hard Drive space required for recording. Recorded file size will vary depending on recording quality settings

Recommended System Requirements:

Operating System:	Windows XP Home Edition Windows XP Professional
Processor:	Pentium 4 – 3 GHz Processor (or equivalent)
Memory:	1024 MB RAM
Hard Drive:	50 MB Installation space * Additional Hard Drive space required for recording. Recorded file size will vary depending on recording quality settings

*** Please refer to the Netviewer Application Guide for further details**

3 SYSTEM INCLUDES

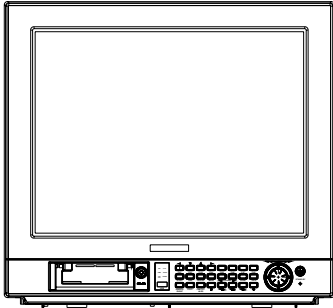

**21" Flat Screen
CRT/DVR Combo**



**4 x Cameras (SG7518)
with camera stand**



**4 x Camera
Extension Cables**



**2 x HDD
Cartridge**



**1 x Ethernet
Cable**



**1 x Net Viewer
CD**



**AC Power
Cable**



System Owners Manual



Netviewer Manual

NOTE: CHECK YOUR PACKAGE TO MAKE SURE THAT YOU RECEIVED THE COMPLETE SYSTEM, INCLUDING THE COMPONENTS SHOWN ABOVE.

4 **GETTING STARTED**

1 Connect the AC Power Cord to the AC Input of the 21" Flat Screen CRT / DVR Combo and plug into an electrical outlet. Connect the cameras into the camera inputs (BNC or DIN) found on the back of the Unit.

Plug one end of the Ethernet cable into the Ethernet Port of the 21" Flat Screen CRT / DVR Combo and the other end into an open Ethernet port of the router.

Turn the Main Power Switch ON.

When power is applied, the unit will go through an internal diagnostic test. You will see...

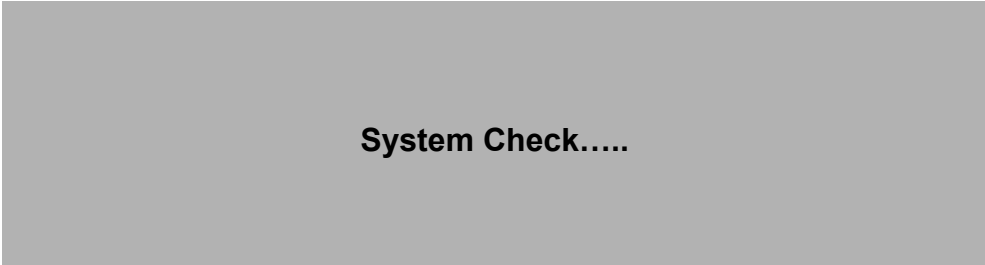

System Check.....

followed by...



Dynamic IP Request . . OK

then..

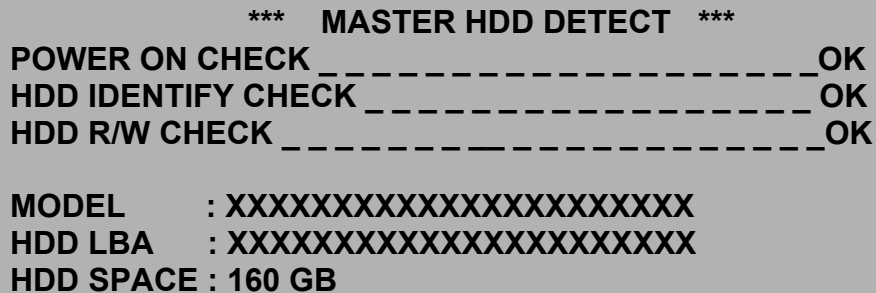

```
*** MASTER HDD DETECT ***
POWER ON CHECK _____OK
HDD IDENTIFY CHECK _____OK
HDD R/W CHECK _____OK

MODEL      : XXXXXXXXXXXXXXXXXXXXXXXX
HDD LBA    : XXXXXXXXXXXXXXXXXXXXXXXX
HDD SPACE  : 160 GB
```

 100 %

NOTE: The unit is equipped with a 160GB MASTER HDD. If the MASTER HDD is not properly connected, the system will report a "FAIL" message. If this occurs, switch off the power to the unit and reconnect the HDD into the HDD Cartridge.

After the unit has completed its internal diagnostic test, the network information will be displayed (for a short period of time). (See below)

```
*** NETWORK INFORMATION ***  
MAC ADDRESS      : XX XX XX XX XX XX  
IP ADDRESS       : 192 . 168 . 001 . 100  
SUBNET MASK      : 255 . 255 . 255 . 000  
GATEWAY          : 192 . 168 . 001 . 001  
PORT             : 5000
```

The unit will then display the video image(s) from the camera.

5 DESCRIPTION OF PARTS AND FUNCTION – FRONT PANEL

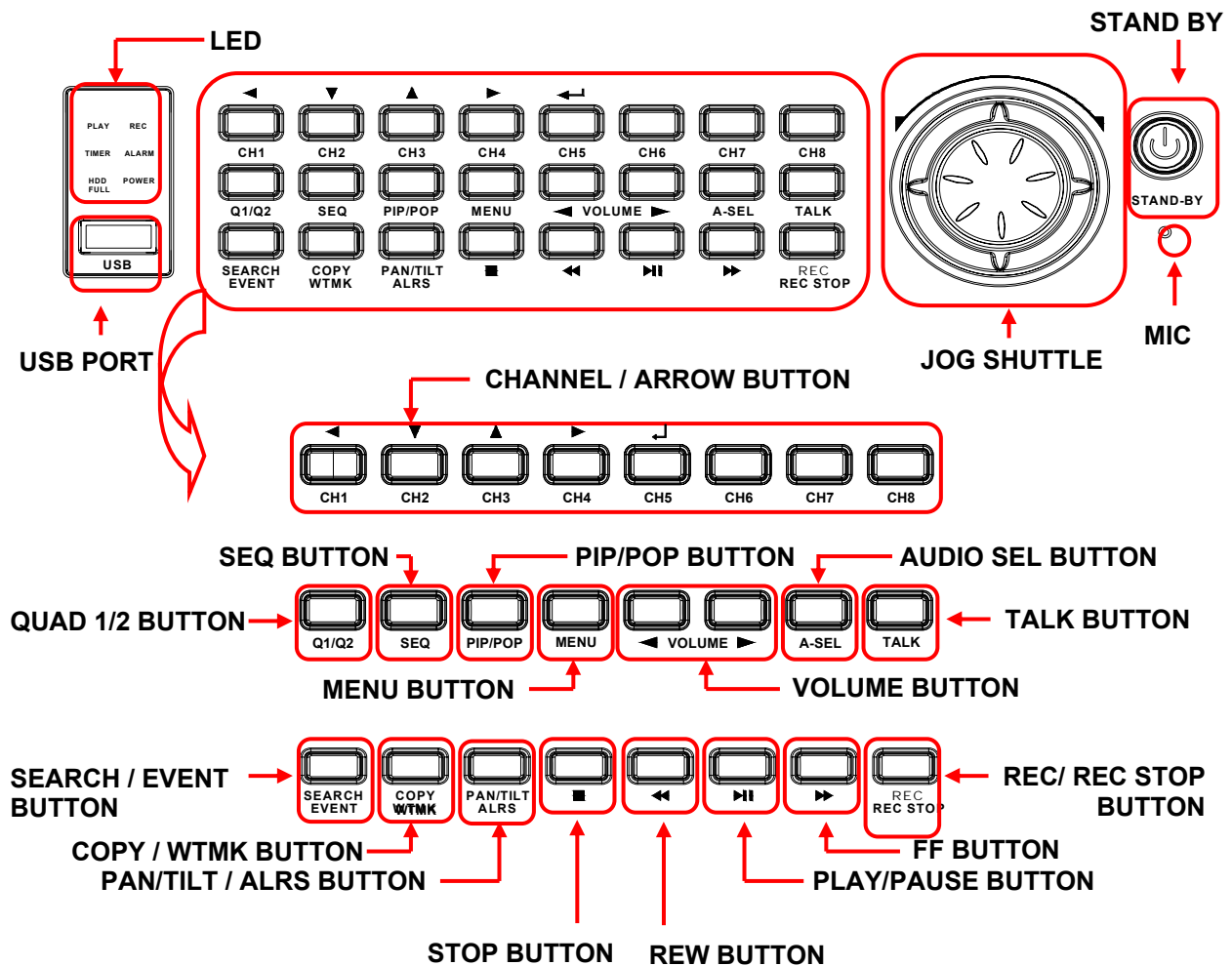

1 CHANNEL / ARROW / BUTTON

These buttons perform the following functions:

- a) Displays a picture in Full Screen. If you are in the Quad1 mode, select the Channel 1 button and hold it for 2-3 seconds to view Camera 1 in Full Screen. To view other camera locations, press CH2 - CH8 buttons.
- b) Freezes a specific camera. You have the option to freeze images in Full or Quad screen mode.
 - In Quad Screen mode: Press a channel button to freeze this channel in the Quad screen; press again to unfreeze;
 - In Full Screen mode: Press the current channel being viewed to freeze it; press again to unfreeze.
- c) Scrolls LEFT / UP / DOWN / RIGHT in Menu mode. These buttons are used to navigate through menu options.
- d) MOVE / ZOOM / FOCUS in Pan / Tilt mode. These buttons are used to arrow button on Pan / Tilt.
- e) \downarrow : This button serves as the ENTER key in Menu mode and Pan/Tilt mode.

2 **QUAD BUTTON**

Pressing this button goes to Quad viewing mode, either Page A (Q1) or Page B (Q2).

3 **SEQ BUTTON**

Used to automatically sequence between all camera locations in full screen view. Press SEQ again to stop sequential viewing. Sequence settings are programmable via the Menu.

4 **PIP/POP BUTTON**

PIP allows you to view two camera locations simultaneously, one being the main channel, the other being viewed as a sub-picture. Dual PIP can also be selected, which displays two sub-pictures as illustrated below. To change between Single PIP and Dual PIP, repeatedly press the PIP button.

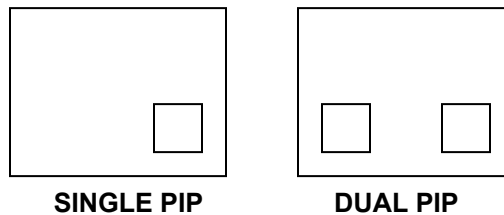

POP divides the screen into 4 screens, with the main channel occupying two-thirds of the screen. Pressing this button will swap the positions of cameras locations (between the Main and Sub screen) in the POP viewing model. To exit POP mode, press the other button.

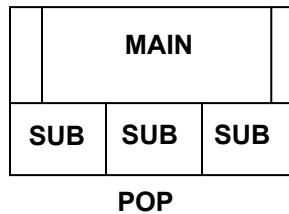

5 **MENU BUTTON**

Press this button to bring up the Main Menu.

6 **VOLUME BUTTON**

Increases or Decreases the audio volume.

7 **AUDIO SEL BUTTON**

In Quad mode, you can select the channel with audio. Pressing this button automatically changes the audio from channel to channel. An audio microphone symbol will appear in the corner of a Quad screen to indicate audio is available on a particular channel.

8 **TALK BUTTON**

By pressing and holding this button the user has the ability to talk to a specific camera location. This button must be pressed the entire time, while talking. To listen to the camera location, release the Talk button.

9 SEARCH / EVENT BUTTON

- a) **SEARCH** : Pressing this button brings up the Search menu, which allows you to quickly find recordings.
- b) **EVENT** : Pressing this button brings up a list of up to 1,000 Events, including Power, Loss and Alarms. You can scroll through Events using the ▲ and ▼ keys, and navigate between Pages of Events using the ◀ and ▶ keys. Press ↵ Button to exit the Event list.

The following letters represent the different types of Events that you may find listed:

- P**: Shows the time when the POWER was turned ON
- A**: Shows the time when a PIR ALARM was triggered
- M**: Shows the time when Pixel-based MOTION detection was triggered
- L**: Shows when a Video LOSS from a Camera occurred
- N**: Starting time of storing data with Manual recording.
- H**: Time of problem occurring in HDD.

10 COPY / WTMK BUTTON

- a) **COPY** : Back up stored data in the HDD to the USB memory key.

NOTE: If the USB Key is connected to the 21" Flat Screen CRT / DVR Combo and it is not recognized or the data copy is not correct, use the USB Key after formatting it with the PC.

- b) **WTMK** : Select to enable or disable the "Water Mark" display.

NOTE: : The WTMK function

Watermarking is an identification code or bit pattern integrated into the multimedia data to aid copyright owners to identify illegally distributed video, or image data. The Watermark proves preservation of integrity (as well as the chance of being manipulated) for recorded images generated by DVR in terms of the legal purpose or confidential use.

The Watermark is usually visible by a detector chip or by special software.

The Watermarking function in this series assures that recorded images are prevented from being manipulated under any circumstances.

11 PAN/TILT / ALRS BUTTON

- a) **PAN/TILT** : This button activates the Pan/Tilt feature.
- b) **ALRS** : During an Alarm, this button will turn off the alarm sound and set the system to the previous setting.

12 STOP BUTTON

Press this button to stop in video playback.

13 REW BUTTON

Press this button to begin high-speed reverse playback during the playback.

14 PLAY / PAUSE BUTTON

- a) Initiates video Playback.
- b) PAUSE : Press this button to pause video in playback.

15 FF BUTTON

Press this button to begin high-speed forward playback during the playback.

16 REC / REC STOP BUTTON

REC: Press this button to start manual recording.

REC STOP: Pressing this button for more than 3 seconds will stop recording.

17 STAND_BY BUTTON

Turns the monitor screen ON/OFF. A red LED indicator light turns ON when the monitor is in Standby mode. Press the button to turn the power ON.

NOTE: The master power switch for the DVR/Monitor is located on the back of the unit.

NOTE: To provide longer life to the monitor, turn the Standby switch OFF when not in use.

18 JOG

Jog dial to the right for forward frame-by-frame playback, or to the left for reverse frame-by-frame playback.

19 SHUTTLE

You can select the playback speed for both forward and reverse by turning the shuttle to the left or right.

20 LED indicators - Status of operation.

- a) REC: LED will be ON when recording data to the HDD.
- b) TIMER: LED will be ON when the TIMER REC is set to ON.
- c) PLAY: LED will be ON when playing data that has been stored in the HDD.
- d) ALARM: LED will be ON when the ALARM or MOTION function is set to ON. When the ALARM or MOTION function is ON, the LED will blink as an Alarm is being triggered.

e) HDD FULL: If the OVERWRITE menu is set up, the LED will not blink in any case. The LED blinks if the HDD has less than 1GB of storage space, and remains ON when the HDD is FULL.

f) POWER: This LED will be illuminated when POWER is applied to the unit.

21 USB PORT

Connect a USB memory stick to back-up the recorded data.

Note: The amount of data that can be transferred based on the capacity of the memory stick.

6 DESCRIPTION OF PARTS AND FUNCTION – BACK PANEL

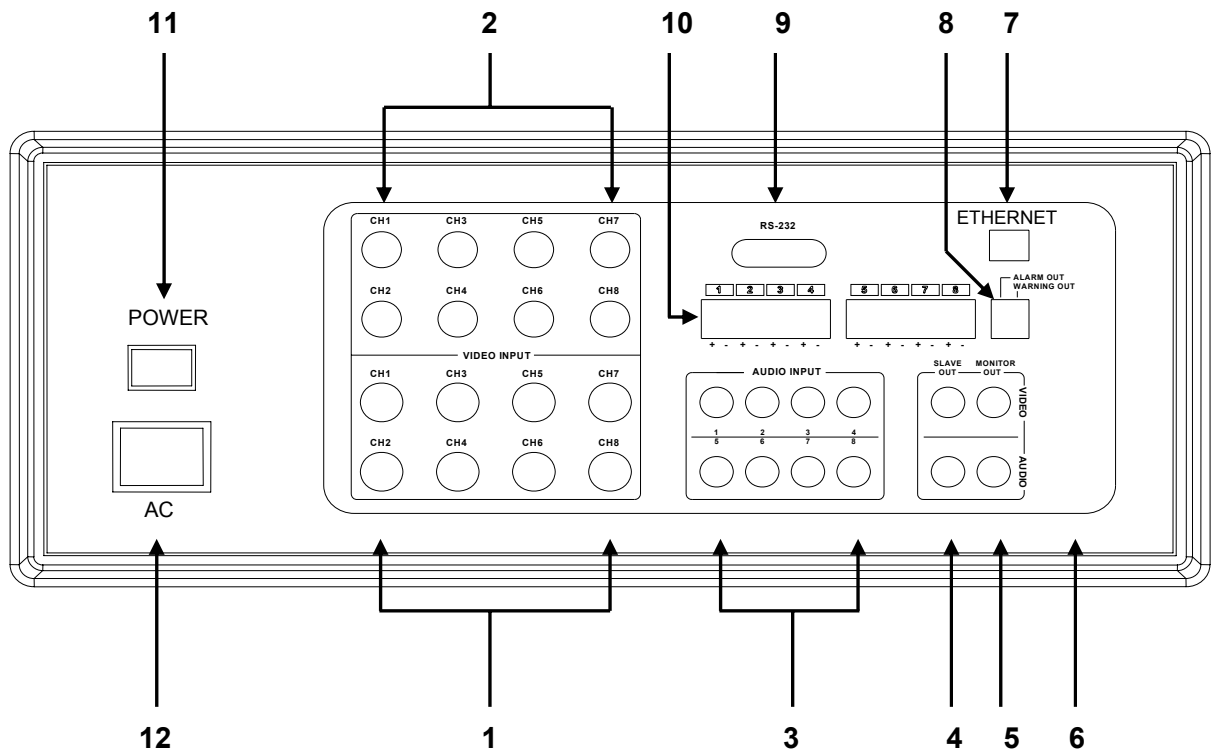

- 1 BNC Camera Inputs - Channel 1-8 camera inputs (for cameras with BNC Video outputs)
- 2 6 Pin DIN Camera Inputs - Channel 1-8 Camera inputs (for cameras with 6 Pin DIN camera outputs).
- 3 RCA Audio inputs - Channel 1-8 Audio inputs (for cameras with RCA Audio outputs)
- 4 Slave A/V Out - Audio/Video Out signal for transmitting to a Slave Monitor or VCR.
- 5 Monitor A/V Out - Audio/Video output to another monitor.
- 6 IDE-SUB - This connector is used to connect an external Slave HDD (NOT AVAILABLE)
- 7 ETHERNET Port - Available to live view and recorded data on the HDD through the Internet or a LAN.
- 8 Sensor Output (Alarm Out, Warning Out) - These terminals are used to connect external Alarm Output devices, such as a siren, security light, etc.
- 9 RS-232C INPUT - Connects to the RS-232C terminal on your computer. For more information on RS-232C communication, refer to *MAIN MENU CONTROL* section.
- 10 Alarm INPUT Terminals - These terminals are used to connect external motion sensors.
- 11 MAIN POWER SWITCH - Used to turn the system ON or OFF.
- 12 AC INPUT – Connects to a Power Plug (AC100-240V, 50/60Hz).

7 MAIN MENU CONTROL

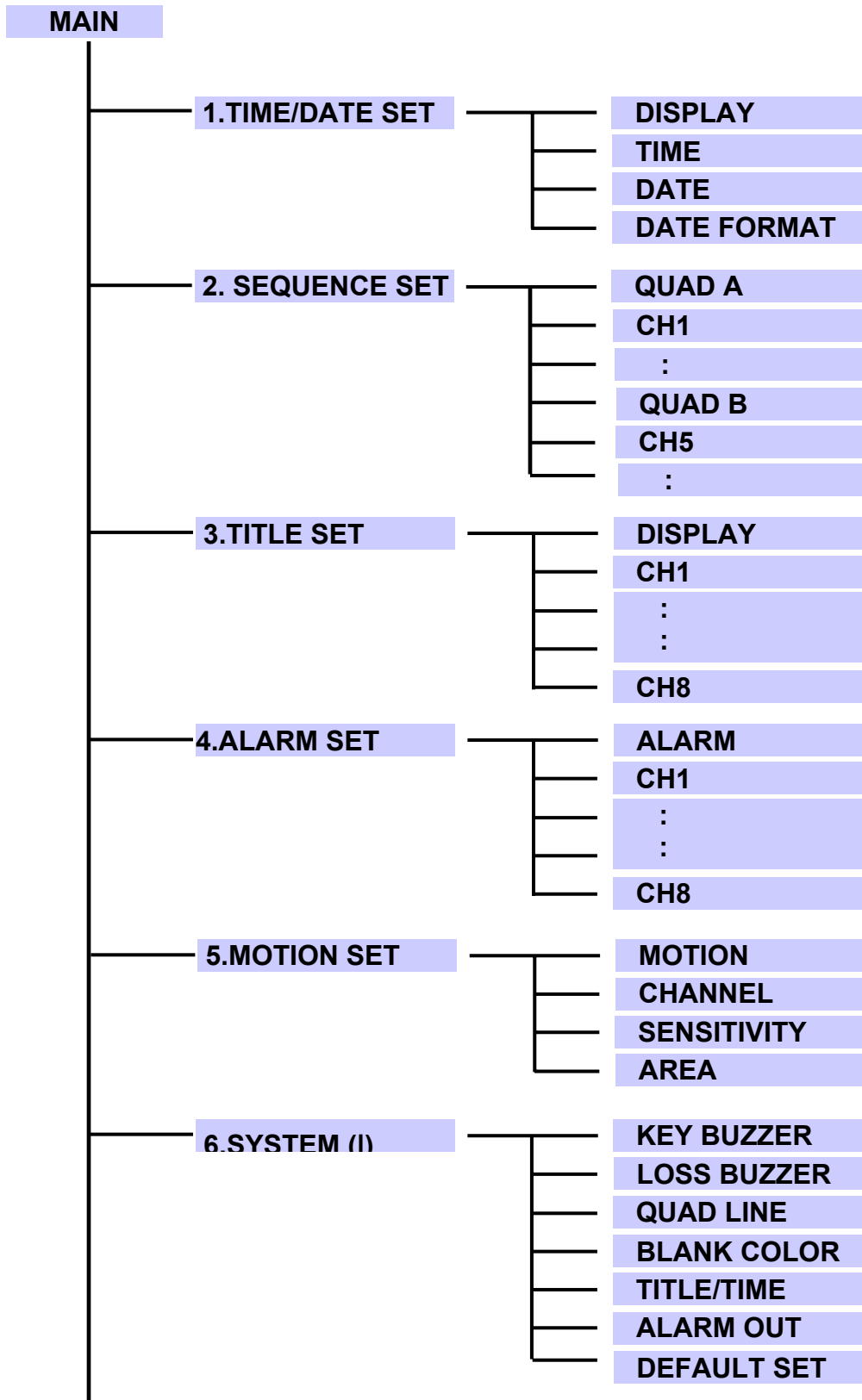

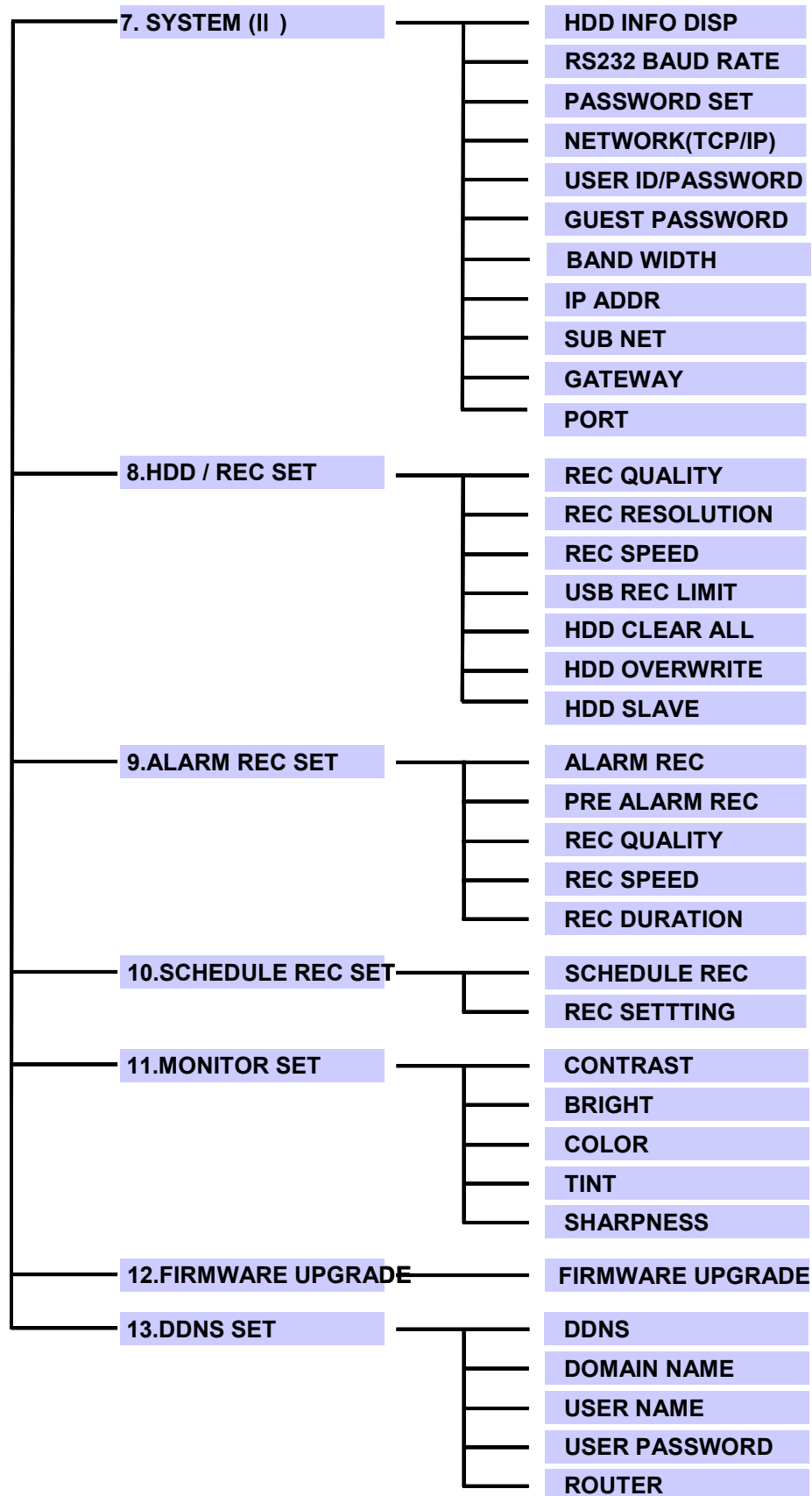

Enter the MENU screen by pressing the MENU button. Scroll through the 12 options by pressing the UP and DOWN buttons. To enter a sub-menu, press the Enter button where the highlighted scroll bar is located. To exit the Main Menu, scroll down to the Exit option and press the Enter button.

NOTE: In sub menu of the Main Menu, you can exit the Menu mode by selecting Exit, or you can return to the Main Menu by selecting Return.

NOTE: The Menu is exited automatically after 60 sec of inactivity.

7.1 TIME / DATE SET

This submenu allows you to change the Time and Date displayed on the monitor, and also program the information you'd like to appear in the On-Screen Display.

- a) DISPLAY : Selecting [Y] enables on screen display of the date & time. Selecting [N] hides this information.
- b) TIME : Change the time (24 hour clock)
- c) DATE : Change the date.
- d) DATE FORMAT : There are three formats to display the date:
 - MM / DD / YYYY : for U.S.A.
 - YYYY / MM / DD : for Asian countries.
 - DD / MM / YYYY : for European countries.

7.2 SEQUENCE SET

This submenu allows you to select how long you'd like each channel to appear on-screen before automatically switching to the next channel in Sequence mode. The Dwell Time is 0-59 seconds selectable for each of the 8 channels and for Quad A / QUAD B mode.

NOTE: Channels without a camera, a Video Loss, or a Dwell Time of zero will be skipped in sequencing.

7.3 TITLE SET

This submenu allows you to change the title of each camera location (up to 8 characters), or remove the titles from the on-screen display.

- a) DISPLAY : Selecting [Y] will enable the camera titles to appear in the on-screen display. Selecting [N] will remove all titles from appearing in the on-screen display.
- b) CH 1 - 8 : Change the titles of each individual camera.

7.4 ALARM SET

This submenu allows you to enable / disable the camera's PIR Alarm function by channel.

- a) ALARM : Selecting [OFF] disables PIR motion detection from triggering any alarm. Selecting [OSD] will allow alarms to be triggered, and the letters "AL" will appear on the screen of the camera location where the alarm is taking place. A third option, [OSD+BUZZER] will both display "AL" and emit a buzzer sound in the event of an alarm.
- b) CH 1-8 : Set the length of alarm time for each channel between 1~59 seconds. Additionally, you can select the Alarm Input. The default setting is OFF - to activate the Alarm on a camera, change the setting to N/O (Normally Open), N/C (Normally Close).

NOTE: Some alternative brand PIR motion sensors have a default setting of N.C (normally closed). In order to activate the alarm on such a PIR motion sensor, change the setting to N.C

7.5 MOTION SET

This submenu allows you to enable / disable the Pixel-based Motion Detection function by channel and set its Sensitivity level.

- a) **MOTION :** Selecting [OFF] disables the Pixel-based Motion Detection function. Selecting [OSD] will allow motion to trigger alarms, and the letters “MD” will appear on the screen of the camera location where the motion is taking place. A third option, [OSD+BUZZER] will display “MD” and emit a buzzer sound in the event that motion is detected.
- b) **CHANNEL :** Select which channels will have the Pixel Motion Sensing feature activated. The Sensitivity level can be set to zero for a channel, which will disable the Motion Sensing ability for that channel.
- c) **SENSITIVITY :** Select the sensitivity level by channel. Level 05 is the highest sensitivity, Level 01 is the least sensitive. Level 00 deactivates Motion Sensing.
- d) **AREA :** Select the area of the screen where the Pixel Motion Sensing feature will be active. The digits below represent the area on the screen where motion is detected.

[00] - Whole screen.

[01] - Top left side of screen.

[02] - Top right side of screen.

[03] - Bottom left side of screen.

[04] - Bottom right side of screen.

[05] - Center of the screen.

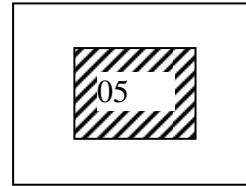
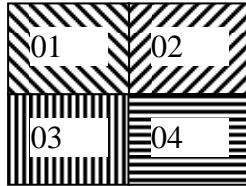
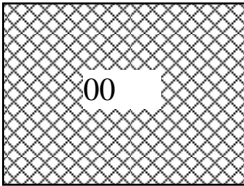

7.6 SYSTEM SET (I)

This sub-menu allows you to configure various preferences on the system, related to Monitor settings.

- a) **KEY BUZZER :** When set to [Y], the system will make a sound when a key is pressed on the remote control or on the main panel of the monitor.
- b) **LOSS BUZZER :** When set to [Y], the system will make a sound when a camera becomes disconnected.
- c) **QUAD LINE :** Activates and deactivates the border line in Quad mode.
- d) **BLANK COLOR :** Choose between blue, gray or black as the background screen color in Menu Mode.
- e) **TITLE/TIME :** Change the location of on-screen display for Time/Date and camera titles. T/R/B/L represents Top / Right / Bottom / Left respectively. Therefore, for example, the setting “TR/BL” would display the Title in the Top-Right corner of the screen, and the Time in the Bottom Left corner.
- f) **PAN/TILT(CH1) :** Activates Pan/Tilt mode to become accessible.

NOTE: if the PAN/TILT function is enabled, CH1 will not trigger when an external alarm occurs.
- g) **ALARM OUT :** Select the Alarm Out setting, which is defaulted to NO (Normally Open) for triggering external devices.

-
- h) **DEFAULT SET** : Selecting [Y] resets all programmed settings back to the default factory settings (except for the time & date).

NOTE: If you perform a **DEFAULT SET**, the programmed data you have entered for the DDNS will be automatically deleted. You need to set the data again.

7.7 SYSTEM SET (II)

This sub-menu allows you to configure various preferences on the system, related to DVR settings.

- a) **HDD INFO DISP** : Sets the display settings for information on the HDD status. This can be displayed as a percentage of HDD space used, or amount of Bytes available, or the HDD information display can be set to OFF.
- b) **RS232 BAUD RATE** : Sets the speed at which the RS 232 input and the computer communicate. Baud Rate, which is the rate of data transmission, can be set to: OFF, 2400, 4800, 9600, or 19200.
- c) **PASSWORD SET** : If you select [Y], you will need to input a password when you enter the Main Menu, and [N] will allow you into the menu without a password. Changes your password for accessing the Menu. The password must be 4 digits.
- d) **NETWORK (TCP/IP)** : There are 3 selections to choose
 - Dynamic IP: enabling this option will result in the unit automatically obtaining an IP address from the Router
 - Static IP: Enabling this option will allow the user to set their IP address
 - OFF: if this option is enabled, networking will be disabled.
- e) **USER ID/PASSWORD** : User can set password for Master ID and account. Default value - ADMIN
- f) **GUEST PASSWORD** : User can set password for GUEST account. Default value – GUEST

NOTE: Master gets full accessibility in network whereas GUEST can view only

- g) **BAND WIDTH**
- h) **IP ADDR** : Set IP address for enabling network.
Default value - 192 168 001 100
NOTE: automatically set when Dynamic IP is enabled
- i) **SUB NET** : User can set Subnet Mask value for enabling network.
Default value - 255 255 255 0
NOTE: automatically set when Dynamic IP is enabled
- j) **GATEWAY** : Setting up Gateway value for enabling network.
Default value - 192 168 001 001
NOTE: automatically set when Dynamic IP is enabled
- k) **PORT** : Setting up Port value for enabling network.
Default value - 5000

7.8 HDD / REC SET

This submenu allows you to set the Record parameters for your Hard Disk Drive.

-
- a) REC QUALITY : Sets the quality level of recording.

Available settings are : Basic, Normal, High and Best.

NOTE: Higher quality recording consumes more memory on your HDD. Please refer to **RECORDING TIME (IN HOURS)** on page 30.

- b) REC RESOLUTION
- c) REC SPEED : Allows you to set the Images Per Second for recording. Available IPS settings are: 1, 2, 3, 5, 10, 15, 30 & 60. The speed of 60 IPS is also known as “Real Time”. 1 IPS is the slowest Time Lapse speed; it will allow for the longest recording durations as it records less information.
- d) HDD CLEAR ALL : Press the ↵ button and “MASTER” will appear, then press the ◀ button. Since this function will delete ALL the recorded video on the Hard Drive, you’ll have to confirm that this is what you want to do. The system will prompt “REALLY?”. Select [Y] to confirm the HDD Clear.
- e) HDD OVERWRITE : Select [Y] to have the DVR/MONITOR automatically overwrite previously recorded video in the event of the HDD becoming FULL. If you select “Y” it will display OVWR (Overwrite) in the on-screen display. If you select “N”, the DVR/MONITOR will terminate recording once it reaches its capacity.

NOTE: HDD Overwrite replaces the earliest recorded video with additional video being recorded. When the HDD is full and the Overwrite option is enabled, the system will automatically record over the oldest video that was recorded.

7.9 ALARM REC SET

This submenu allows you to configure the Recording parameters under the Alarm condition.

- a) ALARM REC : This setting selects whether or not the DVR/MONITOR will record automatically when a Motion Detection or a PIR alarm is triggered.
- b) PRE ALARM REC : Selects the enable or disable of “PRE ALARM”.
- NOTE:** PRE ALARM saves 6secs of image at 5ips before ALARM or MOTION goes off under alarm or motion situation. (When ALARM REC mode is on, images are being stored in HDD.)
- c) REC QUALITY : Selects the Recording Quality level for Alarm Recording (from Basic, Normal, High, or Best).
- d) REC SPEED : Sets the speed of Alarm Recording from 60 / 30 / 15 / 10 / 08 / 04 / 02 / 01 IPS.
- e) REC DURATION : Selects how long the DVR/MONITOR will automatically record after an alarm is triggered. Available duration times are: [20SEC / 30SEC / 1MIN / 2MIN / 5MIN and CONTIN]. CONTIN refers to Continuous recording.

7.10 SCHEDULE REC SET -

This Submenu allows you to Schedule times in which you’re programming the DVR/MONITOR to record automatically.

- a) SCHEDULE REC : Select from the following types of Scheduled recordings:
- [DAILY] - Recording will be carried out according to a specified time on a daily schedule.
- [OFF] - No schedule.

[ONCE] - Recording will be carried out one time, according to the schedule.

- b) N0-N7 : Total 8 REC can be set up from N0 to N7.

Each Schedule REC can control Start TIME/DATE, End TIME/DATE and REC Quality as well as REC Speed can be set up in this mode.

NOTE: When SCHEDULE REC is set up, the recording time should not be overlapped from one scheduled recording to another. If it is overlapping this will **result in a loss in recorded** activity and the schedule may be ignored.

To delete a scheduled recording, place the cursor on the selected time and press the , key. "CURRENT LINE DELETE? [Y] / [N]" is then displayed. If [Y] is selected, the selected schedule is deleted.

7.11 MONITOR SET

This submenu allows you to adjust the Picture settings of the monitor. You can switch between Full or Quad screen views while adjusting the monitor settings by pressing the ◀ and ▶ keys.

- a) CONTRAST : Changes the contrast of the picture.
- b) BRIGHT : Changes the brightness of the picture.
- c) COLOR : Changes the color of the picture.
- d) TINT : Changes the tint of the picture.
- e) SHARPNESS : Change the sharpness of the picture.

7.12 FIRMWARE UPGRADE

Used to upgrade to the most recent Firmware. Once you choose this menu, the system will ask you once again whether you will be proceeding with the Upgrade process. Connect the USB Memory with the FIRMWARE to be upgraded and click "YES".

NOTE: NEVER TURN OFF OR DISCONNECT THE POWER during this process. If the power goes off during the firmware upgrading process.

NOTE: If the USB Memory is not recognized or not working properly, format the USB Memory and try again.

NOTE: For the latest firmware updates, go to www.lorexcctv.com/support

7.13 DDNS SET

- a) DDNS : Selecting "Y" will enable DDNS Service.
- b) DOMAIN NAME : Put the domain name for the DDNS service. As the maximum character available with this unit will be 8 digits, the domain name should not exceeding 8 characters and your special attention required when you are setting with the DDNS server.
- c) USER NAME : Put the User ID supplied your DDNS server provided you. As the maximum character available with this unit will be 8 digits, the User Name should not exceeding 8 characters and your special attention required when you are setting with the DDNS server.

-
- d) **USER PASSWORD** : Put the Password that you have set with the DDNS server. As the maximum character available with this unit will be 8 digits, the User Name should not exceeding 8 characters and your special attention required when you are setting with the DDNS server.
 - e) **ROUTER** : If you are using the ROUTER for the internet connection, you could set it "YES". Otherwise select "NO".

NOTE: When registering for the DDNS service, you cannot exceed 8 characters for the user name, password, or domain name.

NOTE: If you execute the DEFAULT SET, the previous data you have put for the DDNS will be automatically deleted. You need to set the data again.

NOTE: DDNS STATUS INFORMATION

0, 5: Update Successful

1, 6: Server Connection Error

Other Codes : Program Error

7.14 EXIT

Exits the MENU mode.

8 **PLAYBACK SEARCH**

The DVR/MONITOR allows you to easily find sections of recorded video using the Search feature. Press the SEARCH button to access the "PLAYBACK SEARCH SET" menu.

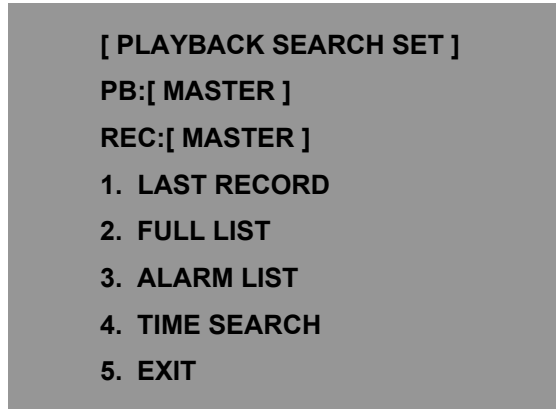

- (1) LAST RECORD: **Plays the most recent recording.**
- (2) FULL LIST: Shows a listing of all recorded video on the HDD, sorted by time.
- (3) ALARM LIST: **Shows a listing of all recorded video triggered by an Alarm.**
- (4) TIME SEARCH: Finds video recorded on a specific date and time that is entered.
- (5) EXIT: **Exits Search mode.**

A listing of up to 1000 recordings can be stored in both the ALARM LIST and the FULL LIST. You can scroll through Recordings using the ▲ and ▼ keys, and navigate between Pages of Recordings using the □ and □ keys. To view a selected piece of video on the list, press the QUAD/↵ button on the highlighted recording. The DVR/MONITOR will play that video. You can stop the video at any time by pressing the STOP button.

9 PLAYBACK OPTION

When the PLAY button is pressed, one of the Playback Search menus will appear. The Playback menu that appears upon pressing PLAY depends on the Search option that was last used. For example, if the last Search option used was a Time Search, then pressing PLAY will bring up the Playback Time Search. If the last Search option utilized was a Last Record, then pressing play will simply play the most recent recording.

9.1 FAST REWIND AND FAST FORWARD

You can increase the speeds of Fast Forward and Rewind on the DVR.

The FF/REW speed is controlled by pushing the FF or REW button during playback of data.

The FF/REW speed can also be controlled by moving the shuttle toward each FF/REW direction.

The FF/REW speed changes by shuttle movement. There are 5 steps to set the speed of the FF from 1x to max. 16x.

There are 5 steps to set the REW speed from 1x to max.

9.2 JOG-SHUTTLE FUNCTION

Jog: Jog the dial clockwise for forward frame-by-frame playback or to the counter clockwise for reverse frame-by-frame playback. Push the PLAY BUTTON to return to the normal play mode.

Shuttle: You can select the playback speed for both forward and reverse by turning the shuttle to the left or right. Shuttle movement changes the playback speed.

9.3 MULTIPLEXING FUNCTION IN PLAYBACK

Because of the Multiplexing function of the DVR, you can switch between individual channels during playback and watch each one in Full-Screen. Press the Channel buttons to view the Full Screen.

10 PAN/TILT ZOOM

The DVR/MONITOR is equipped with a built-in Pan/Tilt Zoom feature, which is only available when used in conjunction with a compatible Pan/Tilt Dome camera.

The Pan/Tilt Zoom feature supports “Pelco D” protocol.

To access and operate the PTZ feature, follow these instructions:

- 1 Connect a compatible Pan/Tilt Zoom Dome camera to the CH 1 camera input.
- 2 Enter the Pan/Tilt Zoom mode by holding the PAN/TILT key on the DVR/MONITOR, or press the Pan/Tilt button on the remote control
- 3 You will see a contracted screen with a blue border.
- 4 Use the Arrow keys to sideways, and ↵ Button to select whether to MOVE and ZOOM the camera.
- 5 If you have selected MOVE, you can use all four arrow keys to Pan and Tilt in all directions. If you selected ZOOM, use the arrow keys to Zoom IN / OUT.
- 6 Select and press ↵ on the EXIT option to escape Pan/Tilt mode.

NOTE: The system automatically exits Pan/Tilt mode after 20 seconds of inactivity.

Refer to the diagram below for an illustration of Pan/Tilt Zoom mode.

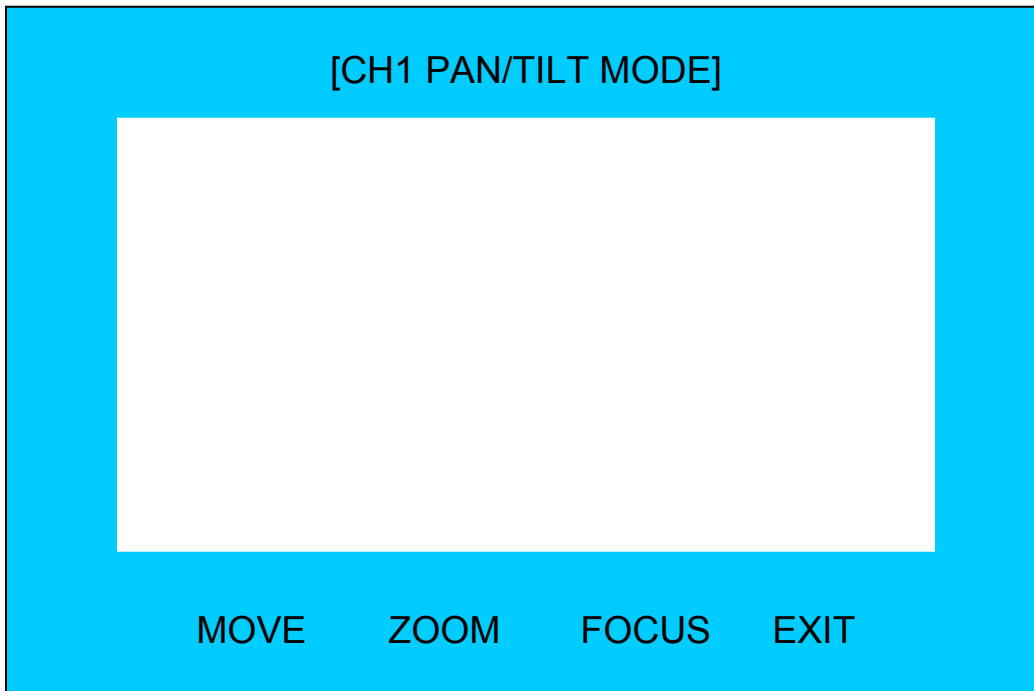

11 REMOTE CONTROL

Features of the Remote Control.

For more details on specific remote control features, refer to the Monitor features

KEY	FUNCTION DESCRIPTION
	SLEEP Mode On/Off.
MENU	Brings up the Main Menu.
1-8	Allows user to select individual cameras
FRZ 1/5	Freezes the Channel 1/5 screen
FRZ 2/6	Freezes the Channel 2/6 screen
FRZ 3/7	Freezes the Channel 3/7 screen
FRZ 4/8	Freezes the Channel 4/8 screen
PAN/TILT	Enters Pan/Tilt Zoom mode.
AUDIO SEL	Selects the Audio channel in Quad mode
KEY LOCK	Locks the buttons on the keypad from functioning.
REC STOP	Stop in video recording.
REC	Initiates Recording.
▲▼	UP / DOWN arrow keys, used in Menu mode.
◀▶	LEFT / RIGHT arrow keys used in Menu mode.
↵ (ENTER)	Confirms selections in Menu mode
VOL	Control Volume decrease/increase.
WTMK	Select the Enable or Disable of "WTMK" while display.
COPY	Back up stored data in HDD to USB memory key.
◀◀	Rewinds video in Playback mode.
▶▶	Fast Forwards video in Playback mode.
⏸	Initiates video Playback mode and Pauses video.
■	Stops video Playback.
▶▶	Stops video Playback.
QUAD	Displays Quad screen.
SEQ	Initiates automatic channel scan.
PIP	Displays PIP Mode and Main Screen change.
PIP-SUB	Changes the Sub-screen in PIP mode.
SEARCH	Brings up the Playback Search mode.
EVENT	Brings up a listing of Events
ALRS	Turns the Alarm sound OFF.
POP	Displays POP Mode and Main Screen change.

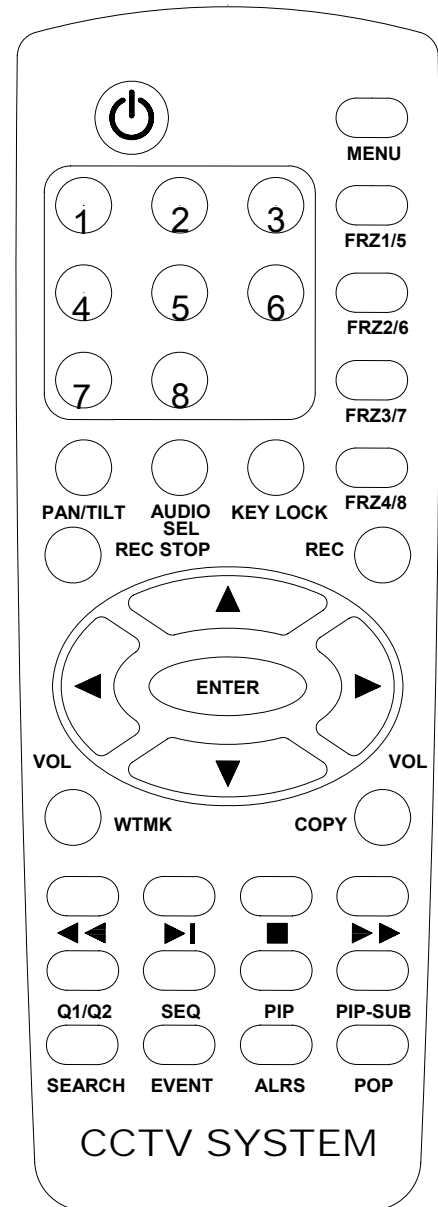

NOTE : When the units shows the normal screen, you could press "ENTER" and the System Information will be shown. The System Information will be show for 1minute and automatically disappear. If you press "ENTER" one more time, the System Information will disappear.

12 CAMERA (DIN Connector) INSTALLATION

Connect the camera to the CAMERA INPUT on the rear panel of the system.

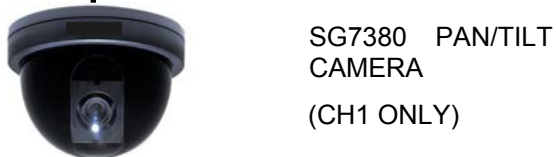
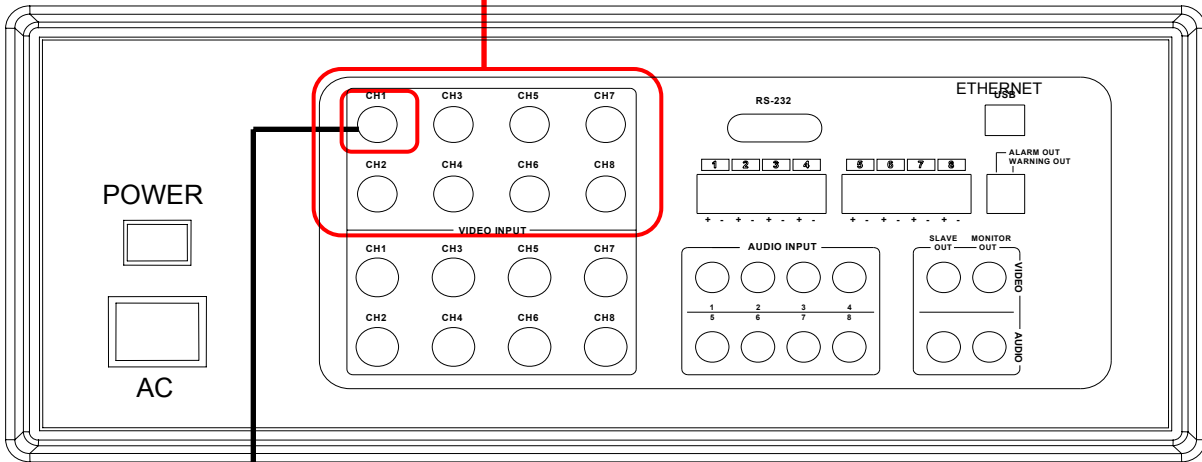

13 CAMERA (BNC Connection) INSTALLATION

Connect the camera to the CAMERA INPUT on the rear panel of the system.

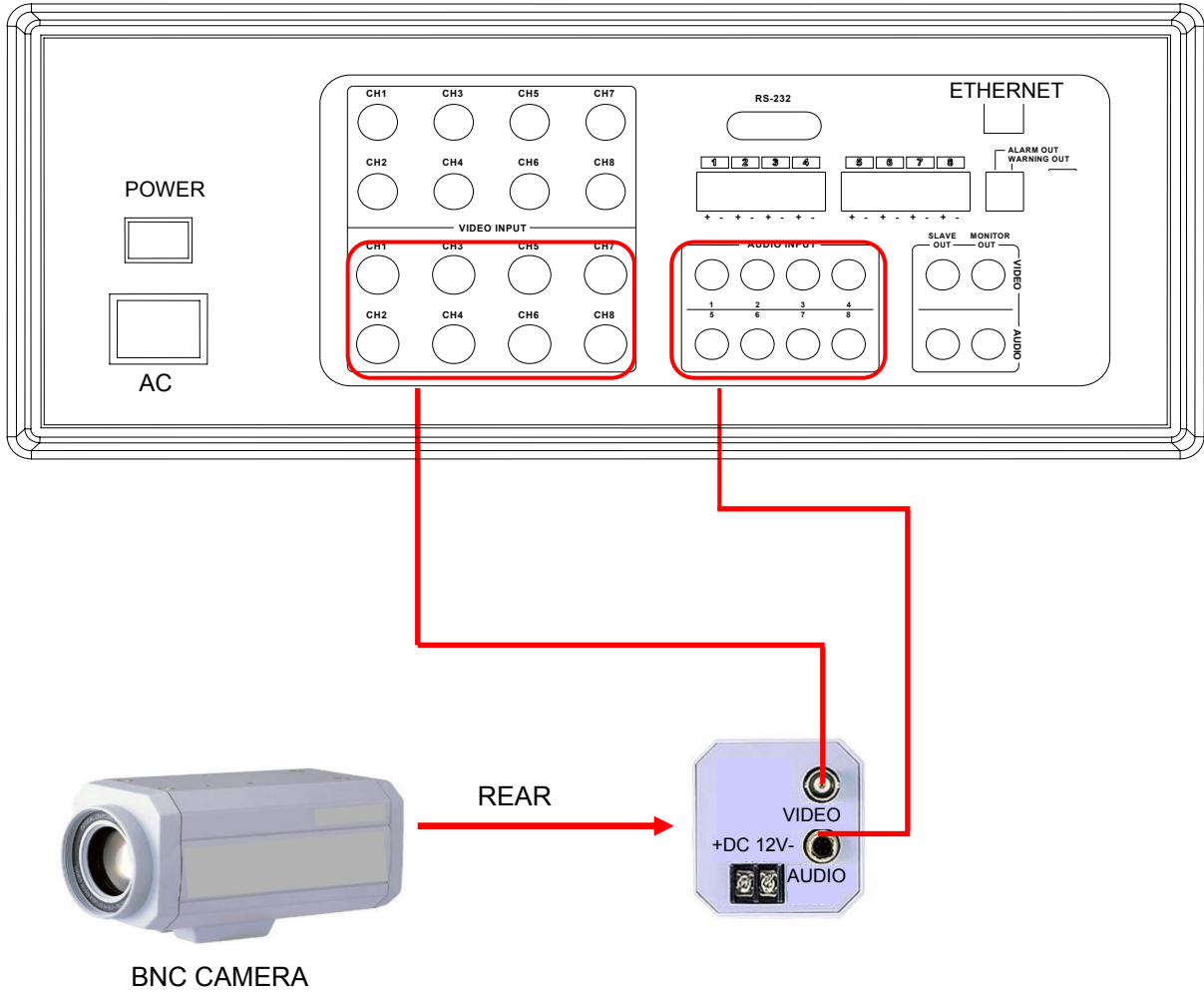

14 MONITOR AND STANDARD VCR INSTALLATION

Connect the camera to the CAMERA INPUT on the rear panel of the system

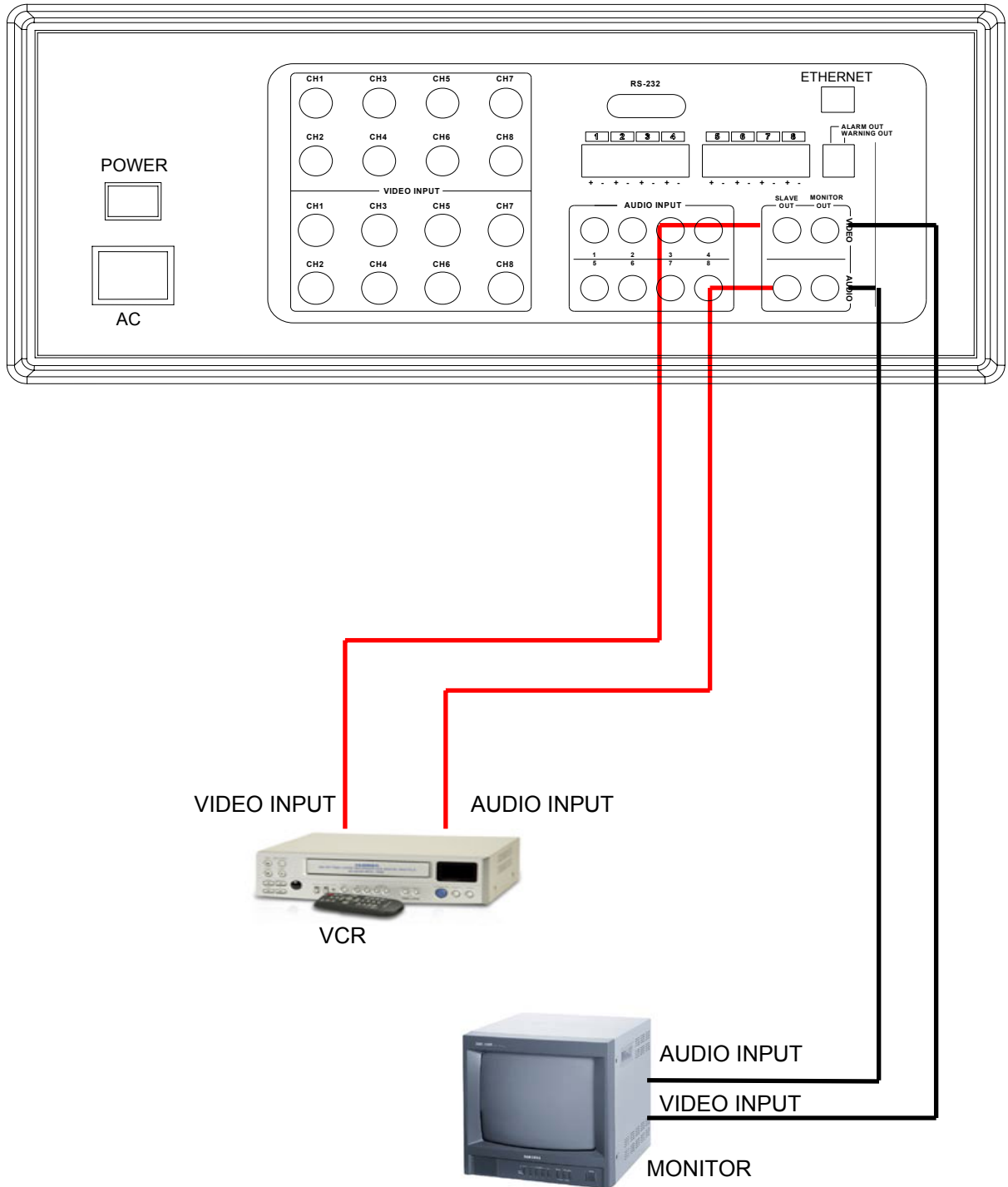

15 ETHERNET (NETWORK), EXTERNAL ALARM DEVICE INSTALLATION

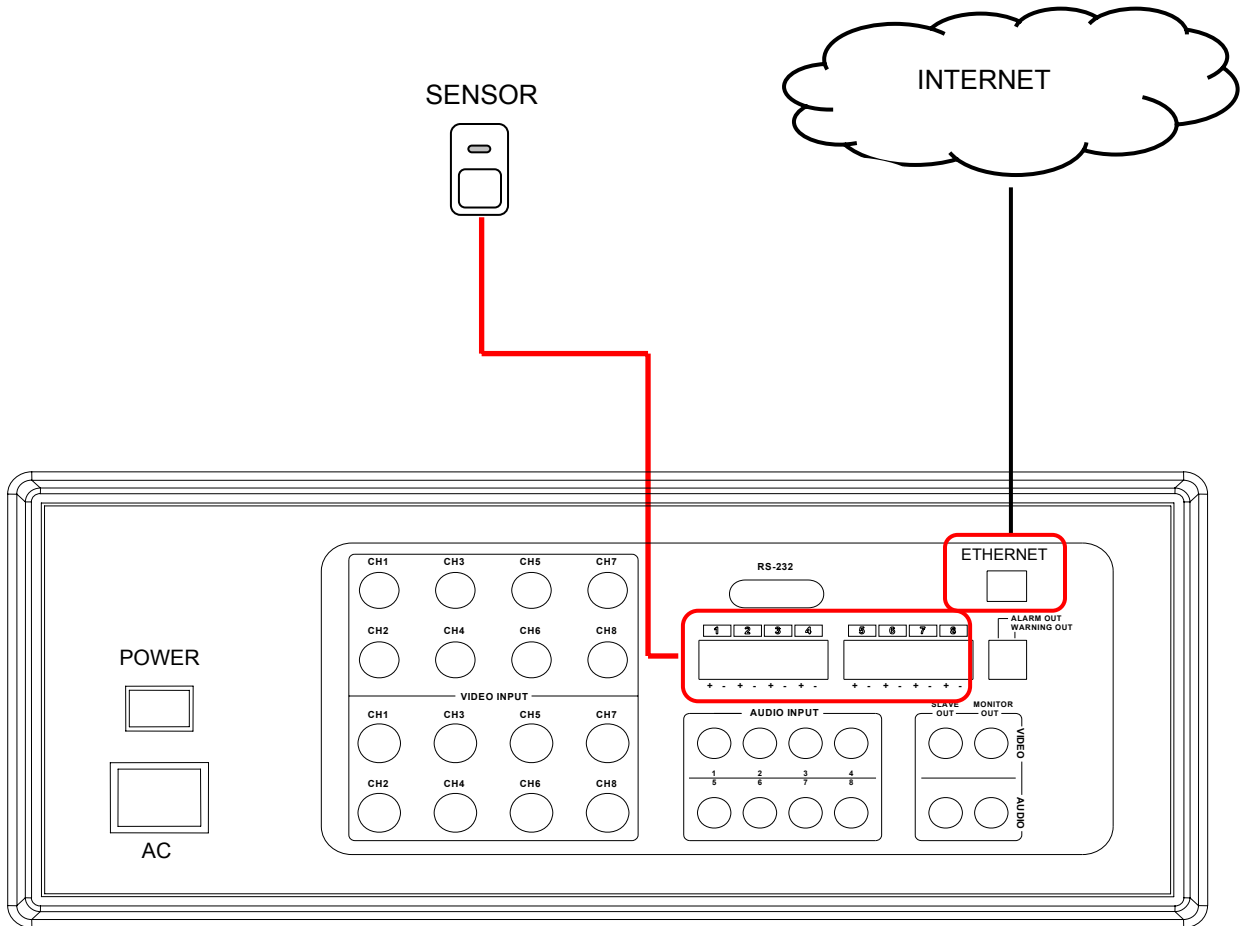

16 NETWORK IMAGE SIZE AND SPEED

	720 X 240		360 X 240	
	IMAGE SIZE	IPS	IMAGE SIZE	IPS
BASIC	16K ~ 17K	10 ~ 15	10K ~ 11K	23 ~ 28
NORMAL	19K ~ 20K	09 ~ 14	11K ~ 12K	23 ~ 28
HIGH	23K ~ 24K	09 ~ 14	14K ~ 15K	15 ~ 20
BEST	32K ~ 33K	09 ~ 14	19K ~ 20K	10 ~ 15

NOTE: The demanding volume of HDD can be different in depending on the displayed picture.

17 RECORDING TIME (IN HOURS)

BASED ON 160 GB H.D.D.

	720 X 240			
	BASIC	NORMAL	HIGH	BEST
01 IPS	2858	2500	2052	1510
02 IPS	1428	1250	1026	758
03 IPS	946	834	686	504
05 IPS	572	498	412	304
10 IPS	284	250	206	152
15 IPS	190	166	136	100
30 IPS	94	84	68	50
60 IPS	48	42	34	26

	360 X 240			
	BASIC	NORMAL	HIGH	BEST
01 IPS	4444	3902	3200	2388
02 IPS	2254	1952	1616	1194
03 IPS	1496	1300	1074	800
05 IPS	898	780	646	480
10 IPS	450	390	322	240
15 IPS	300	260	214	160
30 IPS	150	130	108	80
60 IPS	74	66	54	40

NOTE: 60 IPS is equal to 30 frames per second. 1 IPS is equal to 0.5 frames per second.

NOTE: The demanding volume of HDD can be different in depending on the displayed picture.

18 RECORDING TIME (IN GIGABYTES PER HOUR)

	720 X 240			
	BASIC	NORMAL	HIGH	BEST
01 IPS	0.056GB/H	0.064GB/H	0.078GB/H	0.106GB/H
02 IPS	0.112GB/H	0.128GB/H	0.156GB/H	0.211GB/H
03 IPS	0.169GB/H	0.192GB/H	0.233GB/H	0.317GB/H
05 IPS	0.28GB/H	0.321GB/H	0.389GB/H	0.528GB/H
10 IPS	0.562GB/H	0.642GB/H	0.778GB/H	1.06GB/H
15 IPS	0.843GB/H	0.962GB/H	1.17GB/H	1.59GB/H
30 IPS	1.69GB/H	1.92GB/H	2.33GB/H	3.17GB/H
60 IPS	3.37GB/H	3.85GB/H	4.67GB/H	6.34GB/H

	360 X 240			
	BASIC	NORMAL	HIGH	BEST
01 IPS	0.036GB/H	0.041GB/H	0.05GB/H	0.067GB/H
02 IPS	0.071GB/H	0.082GB/H	0.099GB/H	0.134GB/H
03 IPS	0.107GB/H	0.123GB/H	0.149GB/H	0.2GB/H
05 IPS	0.178GB/H	0.205GB/H	0.248GB/H	0.334GB/H
10 IPS	0.356GB/H	0.41GB/H	0.497GB/H	0.668GB/H
15 IPS	0.535GB/H	0.615GB/H	0.745GB/H	1.00GB/H
30 IPS	1.07GB/H	1.23GB/H	1.49GB/H	2.00GB/H
60 IPS	2.14GB/H	2.46GB/H	2.98GB/H	4.00GB/H

NOTE: 60 IPS is equal to 30 frames per second. 1 IPS is equal to 0.5 frames per second.

NOTE: The demanding volume of HDD can be different in depending on the displayed picture.

19 INSTALLING THE HDD

NOTE: The HDD serves the same purpose in the DVR/Monitor as a video cassette does in a VCR. However, installing the HDD is a bit more complicated. Please follow the next steps carefully in order to ensure proper installation.

The compartment located on the front panel of the DVR/MONITOR is the removable Cartridge Casing in which you insert the HDD. The various parts of the Cartridge Casing are labeled for your reference.

- 1 Remove the Cartridge Casing from the DVR.

Lift the Handle and pull towards you. The Cartridge Casing will slide out of the DVR.

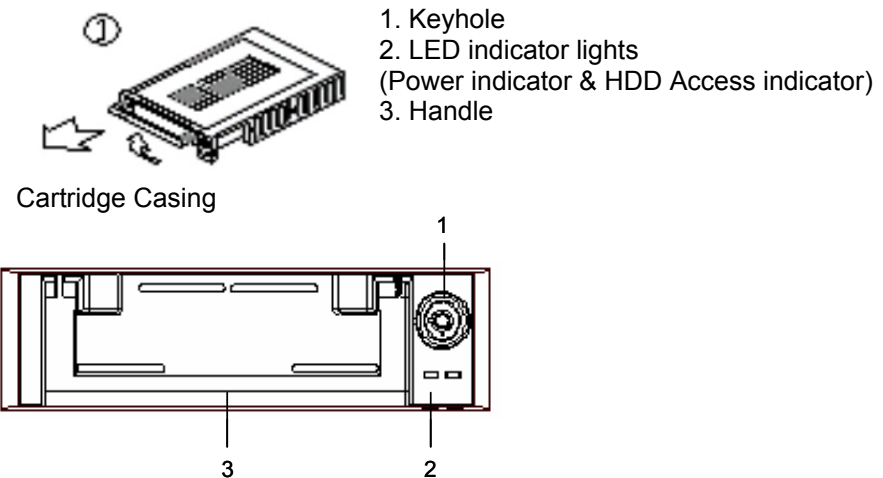

YOU MAY FIND THAT THE CARTRIDGE CASING IS LOCKED. IN THIS CASE, SKIP AHEAD TO STEP 8 TO FIND INSTRUCTIONS ON UNLOCKING THE CABINET, THEN RETURN TO STEP 2.

- 2 Remove the Cover from the Cartridge Casing.
 - a) Unclip the release latch with the word "OPEN" printed beside it by gently pushing on the latch.
 - b) Slide the cover off the Cartridge Casing.



- 3 Connect the HDD into the Cartridge Casing

Take the Hard Disk Drive and Connect the two cables from the back of the Cartridge Casing to the HDD. The cables should be pushed in firmly, but not forcibly.

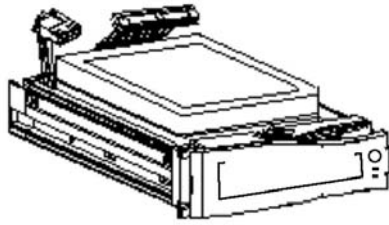

NOTE: The 4 Pin connection is the DC Power cable, and the wider cable is the standard Hard Drive IDE type connection

4 Secure the HDD in the Casing (optional)

Use screws and tighten them, positioning the HDD into place. This step is optional, but it is recommended.

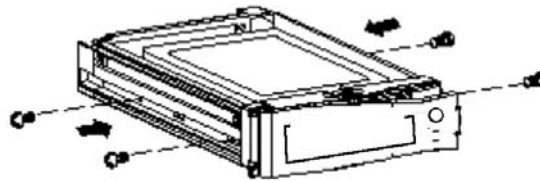

5 Slide the top Cover over the Cartridge Casing

Slide the Cover forward over the Cartridge Case. Ensure it is secured in place over the release latch.

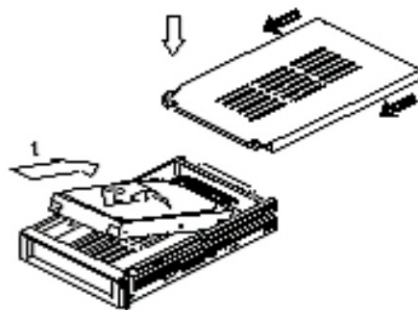

6 Reinsert the Cartridge Casing into the DVR

Fully insert the Cartridge Case into the DVR.

7 Lock the Cabinet

Lock the cabinet by turning the key clockwise.

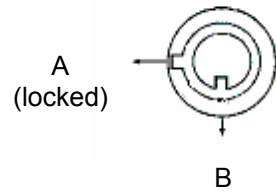

8 If you need to unlock the cabinet, turn the key counter-clockwise from the position shown above.



IF YOU DO NOT LOCK THE CABINET, THE DVR/MONITOR SYSTEM WILL NOT FUNCTION PROPERLY

20 TECHNICAL SPECIFICATIONS

<u>DVR</u>	
Recording Speed :	60 Fields / Sec.
HDD Capacity :	400GB (Max.)
Recording Video Quality :	Basic, Normal, High, Best
Recording Mode:	Normal recording, Alarm (Alarm, Motion) recording, Schedule recording
Playback Mode :	Normal play mode, FF/REW
Video Display Mode :	Full mode, Quad mode, Sequential mode, PIP mode, POP mode
Video Input :	8 BNC Input port, 8 Mini DIN Input port (CH1 Mini Din Port - PAN/TILT video input available)
Audio Input :	8 RCA Input port
Video Output :	2 Composite Output port
Audio Output :	2 RCA Output port
Alarm In/Out :	PIR sensor Input, Alarm Output
Compression Rate:	15~50K Byte / Frame
View Resolution:	720 (H) X 480 (V)
Record Resolution:	720 (H) X 240 (V)
Display Frame:	30 Frames/sec
Recording Frame	Max.60 IPS Note: 60 FPS (120IPS) at 320x240
<u>OS</u>	Embedded LINUX
Power Consumption:	95W (Max.)
Power Input:	AC 100V ~ 240V 50/60Hz (UL Approved)
Operating Temperature:	0°C ~ 40°C (32°F ~ 104°F)
Storage Temperature:	-20°C ~ 70°C (-4°F ~ 158°F)
Weight :	57 Lbs. (26Kg)
Dimensions:	19.7"(W) X 18.6"(W) X 18.2"(W)

Because our products are subject to continuous improvement, SVII and its subsidiaries reserve the right to modify product design and specifications without notice and without incurring any obligation. E&OE

21 TROUBLESHOOTING

If the system does not function properly, please check the following points.

	PROBLEM	REMEDY
MONITOR	Too dark or bright picture	Readjust the CONTRAST or BRIGHTNESS controls
	Poor picture quality	Clean the camera lens. Readjust the CONTRAST or BRIGHTNESS controls.
	Picture but no sound	Adjust the volume
	Picture, but no control	Reset the system by turning off the main power and unplugging the system. Turn the system on again after 30 seconds.
	Shrinking Picture	Check the condition of the power source.
	NO POWER	Make sure the AC Cord is connected properly and the power switch is "ON"
DVR	HDD not found	Re-insert HDD as per the <i>INSTALLING THE HDD</i> section. Make sure that the HDD cartridge is locked.
	Keypad doesn't work	Remove the Key Lock
	Recording stopped	The HDD is Full, and Overwrite is not enabled

22 CARE AND MAINTENANCE

Please follow these instructions to ensure proper care and maintenance of this system

Keep your monitor and camera dry. If it gets wet, wipe it dry immediately.

Use and store your unit in normal temperature environment. Extreme temperatures can shorten the life of the electronic devices.

Handle the monitor carefully. Dropping it can cause serious damage to the unit.







Occasionally clean the unit with a damp cloth to keep it looking new.

Do not use harsh chemicals, cleaning solvents, or strong detergents to clean the unit.

Keep the unit away from excessive dirt and dust. It can cause premature wear of parts.



It's all on the web

-  **Product Information**
-  **Specification Sheets**
-  **User Manuals**
-  **Software Upgrades**
-  **Quick Start Guides**
-  **Firmware Upgrades**



VISIT
www.lorexcctv.com

www.lorexcctv.com

Lorex Technology Inc.