

SPECIFICATIONS

Model	C-T1421	C-T2021
AC Power Input:	110V-240V 50Hz/60Hz (Rating), 100V-260V 50Hz/60Hz (Operating)	
AC Power Consumption:	44 Watts	70 Watts
TV Color System:	PAL-M, PAL-N, NTSC-M	
Picture Tube:	33.6 cm (measured diagonally)	48 cm (measured diagonally)
Audio Power Output Rating:	0.75+0.75 Watts (monaural)	1.5 + 1.5. Watts (monaural)
Speaker:	10.8 cm x 4.5 cm Full Range, 8 ohm x 2	10.8 cm x 4.5 cm Full Range, 4 ohm x 2
Input:	Video: 1.0Vp-p 75 ohm Audio: 300 mV, 47K ohm	
EARPHONE jack:	3.5 mm ø x 1	
Tuner Type:	181 Channel, Quartz PLL Frequency Synthesized	
Remote Control:	Infrared, Direct Access, 2 x AAA batteries	
Receiving Channels:	VHF 2-13 UHF 14-69 CATV 01-97 (5A)-(A-3) 98-99 (A-2)-(A-1) 14-22 (A)-(I) 23-36 (J)-(W) 37-65 (AA)-(FFF) 66-125 (GGG)-(125)	
Antenna Input Impedance:	75 Ohm (VHF/UHF/CATV) Coaxial Input	
Dimensions:	46 cm (W) x 36.3 cm (D) x 31.8 cm (H)	60 cm (W) x 48 cm (D) x 44.6 cm (H)
Weight:	9.5 kg	17.5 kg

ACCESSORIES:

- Remote Control
- AAA Batteries x 2
- 300-75 ohm Matching Transformer
- Telescopic Antenna (C-T1421 only)

Specifications are subject to change without notice.



VICTOR COMPANY OF JAPAN LIMITED

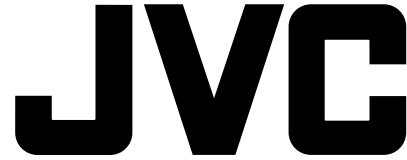

**COLOR TELEVISION
USER'S GUIDE**

*For models:
C-T1421
C-T2021*

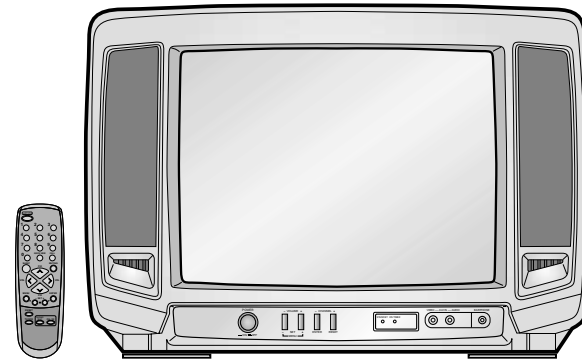

IMPORTANT NOTE TO THE CUSTOMER:

In the space below, enter the serial number for your television (located on the rear of the television cabinet). Staple your sales receipt or invoice to the inside cover of this guide. Keep this user's guide in a convenient place for future reference. Keep the carton and original packaging for future use.

Serial Number _____





The lightning flash with arrowhead symbol, within an equilateral triangle is intended to alert the user to the presence of uninsulated dangerous voltage within the product's enclosure that may be of sufficient magnitude to constitute a risk of electric shock persons.



The exclamation point within an equilateral triangle is intended to alert the user to the presence of important operating and maintenance (servicing) instructions in the literature accompanying the appliance.

CAUTION: Changes or modifications not expressly approved by the party responsible for compliance with the FCC Rules could void the user's authority to operate this equipment.

WARNING: TO PREVENT FIRE OR SHOCK HAZARD, DO NOT EXPOSE THIS TV SET TO RAIN OR MOISTURE:

IMPORTANT SAFEGUARDS

1. READ INSTRUCTIONS

All the safety and operating instructions should be read before the unit is operated.

2. RETAIN INSTRUCTIONS

The safety and operating instructions should be retained for future reference.

3. HEED WARNINGS

All warnings on the unit and in the operating instructions should be adhered to.

4. FOLLOW INSTRUCTIONS

All operating and use instructions should be followed.

5. CLEANING

Unplug this unit from the wall outlet before cleaning. Do not use liquid cleaners or aerosol cleaners. Use a damp cloth for cleaning the exterior cabinet only.

6. ATTACHMENTS

The manufacturer of this unit does not make any recommendations for attachments, as they may cause hazards.

7. WATER AND MOISTURE

Do not use this unit near water. For example, near a bathtub, washbowl, kitchen sink, laundry tub, in a wet basement, or near a swimming pool.

8. ACCESSORIES

Do not place this unit on an unstable cart, stand, tripod, bracket, or table.

The unit may fall, causing serious injury, and serious damage to the unit.

8A. An appliance and cart combination should be moved with care. Quick stops, excessive force, and uneven surfaces may cause the appliance and cart combination to overturn.

PORTABLE CART WARNING
(Symbol provided by RETAC)



S3126A

9. VENTILATION

Slots and openings in the cabinet back or bottom are provided for ventilation, and to ensure reliable operation of the unit, and to protect it from overheating. These openings must not be blocked or covered. The openings should never be blocked by placing the unit on a bed, sofa, rug, or other similar surface. This unit should never be placed near or over a radiator or heat source. This unit should not be placed in a built-in installations such as a bookcase or rack unless proper ventilation is provided or the manufacturer's instructions have been adhered to.

10. POWER SOURCE

This unit should be operated only from the type of power source indicated on the rating plate. If you are not sure of the type of power supply to your home, consult your appliance dealer or local power company. For units intended to operate from battery power, or other sources, refer to the operating instructions.

11. GROUNDING OR POLARIZATION

This unit is equipped with a polarized alternating-current line plug (a plug having one blade wider than the other). This plug will fit into the power outlet only one way. This is a safety feature. If you are unable to insert the plug fully into the outlet, try reversing the plug. If the plug should still fail to fit, contact your electrician to replace your obsolete outlet. Do not defeat the safety purpose of the polarized plug, if your unit is equipped with a 3-wire grounding-type plug, a plug having a third (grounding) pin. This plug will only fit into a grounding-type power outlet. This too, is a safety feature. If you are unable to insert the plug into the outlet, contact your electrician to replace your obsolete outlet. Do not defeat the safety purpose of the grounding-type plug.

12. POWER-CORD PROTECTION

Power-supply cords should be routed so that they are not likely to be walked on or pinched by items placed upon or against them, paying particular attention to cords at plugs, convenience receptacles, and the point where they exit from the appliance.

13. LIGHTNING

To protect your unit during a lightning storm, or when it is left unattended and unused for long periods of time, unplug it from the wall outlet and disconnect the antenna or cable system. This will prevent damage to the unit due to lightning and power line surges.

14. POWER LINES

An outside antenna system should not be located in the vicinity of overhead power lines or other electric light or power circuits, or where it can fall into such power lines or circuits. When installing an outside antenna system, extreme care should be taken to keep from touching such power lines or circuits, as contact with them might be fatal.

15. OVERLOADING

Do not overload wall outlets and extension cords as this can result in a risk of fire or electric shock.

16. OBJECT AND LIQUID ENTRY

Do not push objects through any openings in this unit, as they may touch dangerous voltage points or short out parts that could result in fire or electric shock. Never spill or spray any type of liquid into the unit.

17. OUTDOOR ANTENNA GROUNDING

If an outside antenna or cable system is connected to the unit, be sure the antenna or cable system is grounded to provide some protection against voltage surges and built-up static charges, Section 810 of the National Electrical Code, ANSI/NFPA 70, provides information with respect to proper grounding of the mast and supporting structure, grounding of the lead-in wire to an antenna discharge unit, size of grounding conductors, location of antenna discharge unit, connection to grounding electrodes, and requirements for the grounding electrode.

18. SERVICING

Do not attempt to service this unit yourself as opening or removing covers may expose you to dangerous voltage or other hazards. Refer all servicing to qualified service personnel.

19. DAMAGE REQUIRING SERVICE

Unplug this unit from the wall outlet and refer servicing to qualified service personnel under the following conditions:

- When the power-supply cord or plug is damaged.
- If liquid has been spilled, or objects have fallen into the unit.
- If the unit has been exposed to rain or water.
- If the unit does not operate normally by following the operating instructions. Adjust only those controls that are covered by the operating instructions, as an improper adjustment of other controls may result in damage and will often require extensive work by a qualified technician to restore the unit to its normal operation.
- If the unit has been dropped or the cabinet has been damaged.
- If the unit exhibits a distinct change in performance, this indicates a need for service.

20. REPLACEMENT PARTS

When replacement parts are required, be sure the service technician uses replacement parts specified by the manufacturer or those that have the same characteristics as the original part.

Unauthorized substitutions may result in fire, electric shock or other hazards.

21. SAFETY CHECK

Upon completion of any service or repairs to this unit, ask the service technician to perform safety checks to determine that the unit is in proper operating condition.

22. HEAT

The product should be situated away from heat sources such as radiators, heat registers, stoves, or other products (including amplifiers) that produce heat.

23. NOTE TO CATV SYSTEM INSTALLER

This reminder is provided to call the CATV system installer's attention to Article 820-40 of the NEC that provides guidelines for proper grounding and, in particular, specifies that the cable ground shall be connected to the grounding system of the building, as close to the point of cable entry as practical.

EXAMPLE OF ANTENNA GROUNDING AS PER THE NATIONAL ELECTRICAL CODE

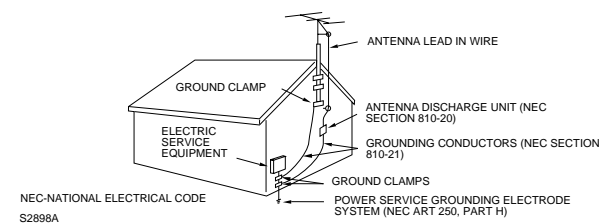

FEATURES

- **181 Channel Tuner** - The tuning system is capable of receiving all 68 VHF/UHF standard broadcast channels that are available in your area. When operating on a cable system, it can tune to the standard VHF channel frequencies plus up to 113 cable channel frequencies. The actual number of channels received depends upon channel reception in your area or your cable system.
- **On-Screen 3 Language Display** - This TV can display the on screen language in English, Spanish or Portuguese.
- **ON/OFF Timer** - Allows you to automatically turn on or off your TV at a set time.
- **Sleep Timer** - Operable from the remote control, this TV can be programmed up to 120 minutes to turn off automatically.
- **Picture Control Adjustments** - The On-Screen display allows precise remote control adjustment of BRIGHTNESS, COLOR, CONTRAST, SHARPNESS, TINT.
- **Closed Captioned Decoder** - Displays text captions or 1/2 of full screen text on the screen for hearing impaired viewers.
- **Front Video Input Jacks** - A VCR or other video device may be hooked up.
- **Auto Voltage** - This TV can be used from a household 110V-240V, 50/60Hz.

LOCATION OF CONTROLS

FRONT

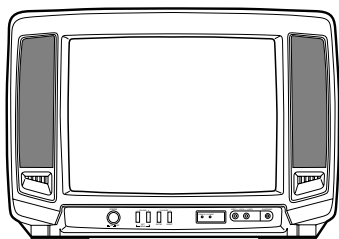

BACK

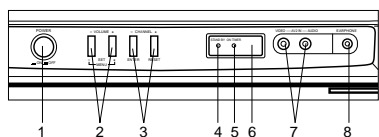
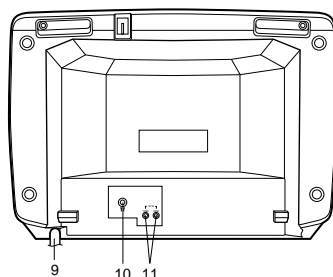

- 1. POWER Button** - Press the POWER button on the front panel to put the TV into standby mode.
- 2. VOLUME +/- Buttons** - Press to raise or lower the volume of the sound.
(MENU Buttons) - Press the both buttons to display the On-Screen menu function.
(SET +/- Buttons) - Press to select the desired setting during On-Screen operations.
- 3. CHANNEL +/- Buttons** - Press to select a higher or lower numbered channel set into memory.
(Power on function) - You can also turn on the TV by pressing the CHANNEL + or - button on the front panel when the TV is in standby mode.
(ENTER Button) - Press to enter or select information for On-Screen operations.
(RESET Button) - Press to reset the On-Screen picture adjustments to their factory preset positions.

- 4. STAND BY Indicator** - This indicator lights up showing the unit is in standby mode.
- 5. ON TIMER Indicator** - This indicator lights up when ON TIMER program is turned ON.
- 6. Remote Sensor** - Signals from the Remote Control unit are received here.
- 7. AV 2 IN Jacks (Front)** - Audio and video signal cables from an external source can be connected here.
- 8. EARPHONE Jack** - Plug an earphone with an 1/8 miniplug into this jack for listening.
- 9. AC Power Cord** - Connect to the AC outlet.
- 10. VHF/UHF IN (ANT) Jack** - Connect a VHF/UHF antenna or CATV cable to this jack.
- 11. AV 1 IN Jacks (Rear)** - Audio and video signal cables from an external source (ex. VCR) can be connected here.

REMOTE CONTROL

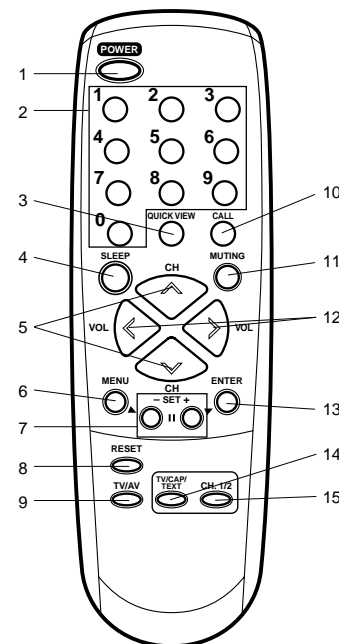

- 1. POWER Button** - Press to turn the TV on or off when the TV is standby mode.
- 2. 10-key pad** - Allows direct access to any channel.
- 3. QUICK VIEW Button** - Switches between the present channel and the last channel selected.
- 4. SLEEP TIMER Button** - Sets the TV to turn off automatically after up to 120 minutes.
- 5. CH ^/v Buttons** - Press the ^ button to change to a higher numbered channel set into memory. Press the v button to change to a lower numbered channel set into memory.
(Power on function) - You can also turn on the TV by pressing the CHANNEL ^ or v button on the remote control when the TV is in standby mode.
- 6. MENU Button** - Press to display the On-Screen menu function.
- 7. SET +/- Buttons** - Press to select the desired setting during On-Screen operations.
- 8. RESET- Button** - Press to reset the On-Screen picture adjustments, clock setting and ON/OFF timer setting.
- 9. TV/AV Button** - Switches between the TV and external input sources.
- 10. CALL** - Displays the current status time, channel (or Input), the present settings on the TV screen.
- 11. MUTING Button** - Press to turn off the sound. Press again to turn the sound back on.
- 12. VOL >/< Buttons** - Press the > button to increase, or the < button to decrease the volume level.
- 13. ENTER Button** - Press to enter selected setup.
- 14. TV/CAP/TEXT (Closed Caption) Button** - Switches between Caption, Text and TV modes for Closed-Captioned programs.
- 15. CH. 1/2 Button** - Switches between Channel 1 and Channel 2 in the Closed Caption mode.

REMOTE CONTROL

(CONTINUED)

BATTERY INSTALLATION

1. Open the battery compartment cover in the direction of the arrow.

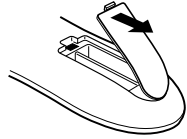

2. Install two "AAA" (penlight size) batteries, paying attention to the polarity diagram in the battery compartment.

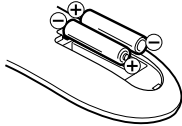

3. Replace the compartment cover.

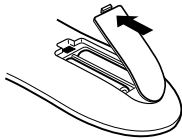

BATTERY PRECAUTIONS

The precautions below should be followed when using batteries in this device:

1. Use only the size and type of batteries specified.
2. Be sure to follow the correct polarity when installing the batteries as indicated in the battery compartment. Reversed batteries may cause damage to the device. To avoid a potential short circuit, insert the "-" end first.
3. Do not mix different types of batteries together (e.g. Alkaline and Carbon-zinc) or old batteries with fresh ones.
4. If the device is not to be used for a long period of time, remove the batteries to prevent damage or injury from possible battery leakage.
5. Do not try to recharge batteries not intended to be recharged; they can overheat and rupture. (Follow battery manufacturer's directions.)

EFFECTIVE DISTANCE OF THE REMOTE CONTROL TRANSMITTER

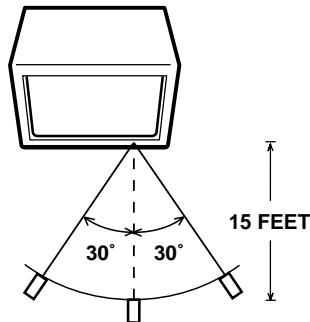

- NOTES:**
- When there is an obstacle between the TV and the transmitter, the transmitter may not operate.
 - When direct sunlight, an incandescent lamp, fluorescent lamp or any other strong light shines on the Remote sensor of the TV, the remote operation may be unstable.

ANTENNA/CATV CONNECTIONS

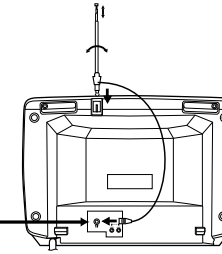
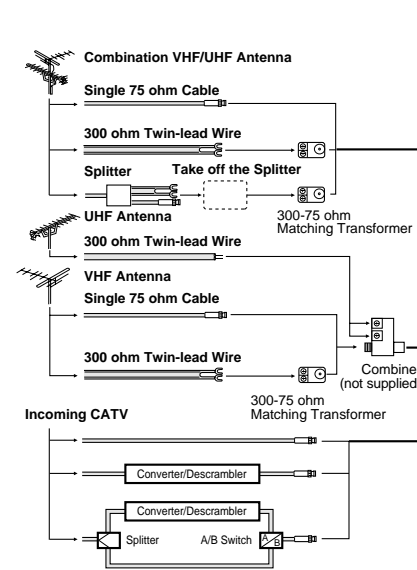

This television has an extended tuning range and can tune most cable channels without using a cable company supplied converter box. Some cable companies offer "premium pay channels" in which the signal is scrambled. Descrambling these signals for normal viewing requires the use of a descrambler device which is generally provided by the cable company.

Indoor Antenna

A single pole antenna is supplied with the unit (C-T1421 only), insert the antenna holder into the mounting hole on the back of the cabinet until it locks into place. Attach the antenna plug to the antenna jack. Adjust the length and angle of the antenna rod to receive the best possible picture.

Separate VHF/UHF Antennas

Connect the 75 ohm Cable from the VHF antenna and the UHF antenna Twin-lead to a combiner (not supplied). Attach the Combiner to the Antenna Jack.

NOTE: If your VHF antenna has a Twin-lead Wire, use the 300-75 ohm Matching Transformer, then connect the Transformer to the Combiner.

For Subscribers to Basic Cable TV Service

For basic cable service not requiring a Converter/Descrambler box, connect the CATV 75 ohm Coaxial Cable directly to the Antenna Jack on the back of the television.

For Subscribers to Scrambled Cable TV Service

If you subscribe to a cable service which requires the use of a Converter/Descrambler box, connect the incoming cable to the Converter/Descrambler box and connect the output of the box to the Antenna Jack on the back of the television. Follow the connections shown left. Set the television to the output of the Converter/Descrambler box (usually channel 3 or 4) and use the Converter/Descrambler box to select channels.

For Subscribers to Unscrambled Basic Cable with Scrambled Premium Channels

If you subscribe to a cable service in which basic cable channels are unscrambled and premium channels require the use of a Converter/Descrambler box, you may wish to use a two-set signal splitter (sometimes called a "two-set coupler") and an A/B Switch box from the cable installer or an electronics supply store. Follow the connections shown left. With the switch in the "B" position, you can directly tune any nonscrambled channels on your TV. With the switch in the "A" position, tune your TV to the output of the Converter/Descrambler box (usually channel 3 or 4) and use the box to tune scrambled channels.

CONNECTION TO OTHER EQUIPMENT

The exact arrangement you use to interconnect various video and audio components to the TV is dependent on the model and features of each component. Check the User's Guide provided with each component for the location of video and audio inputs and outputs.

The connection diagrams in the following are offered as suggestions. You may need to modify them to accommodate your particular assortment of components. The diagrams are intended to show component video and audio interconnections only.

Press the TV/AV button to select the AV mode to use the TV as a monitor. Operate your VCR as usual.

TV/AV SELECTION

If you connect the TV to VCR, camcorder, TV game or DVD you can select by pressing the TV/AV button.

Press the TV/AV button repeatedly to select the desired mode.

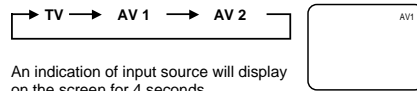

An indication of input source will display on the screen for 4 seconds.

1. To connect the TV to a VCR
(ex. Use AV 1 IN jacks to connect it.)

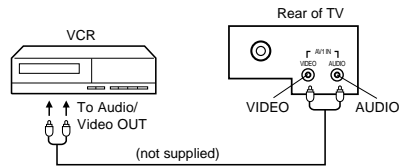

- Select "AV 1" by pressing the TV/AV button to display the VCR picture.

3. To connect the TV to a camcorder
To playback from the camcorder, connect the camcorder to the TV as shown.

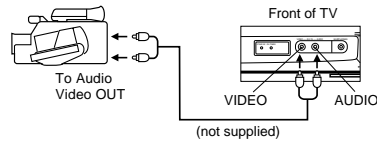

- Select "AV 2" by pressing the TV/AV button to display the camcorder picture.

2. To connect the TV to a TV Game
The TV can also be used as a display device for many video games. However, due to the wide variety of different types of signal generated by these devices and subsequent hook-up variations required, they have not all been included in the suggested connection diagrams. You'll need to consult each component's Owner's Manual for additional information.

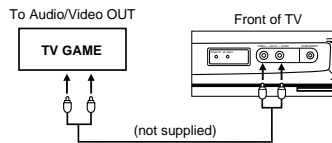

- Select "AV 2" by pressing the TV/AV button to display the TV GAME picture.

SETTING LANGUAGE

This TV can display the channel number, on-screen displays and picture adjustments on the screen in English, Spanish or Portuguese.

On-screen language selection (step 3) will automatically appear on the screen when you press the MENU button initially. Select the language you prefer first, then proceed with the other menu options.

- 1 Press the MENU button.
- 3 Press the SET + or - button until the "▶" indicator points to the desired language: English (ENGLISH), Spanish (ESPAÑOL) or Portuguese (PORTUGUES), then press the ENTER button.

NOTE:
If Spanish or Portuguese is chosen, the Closed Caption indicators will be in the selected language, but the Closed Caption text will not be affected by the language selection.

SETTING CLOCK

You must set the time manually for CALL and ON/OFF TIMER.

- 1 Press the MENU button.
- 2 Press the SET + or - button until the indicator next to "CLOCK SET" begins to flash, then Press the ENTER button.
- 4 Press the SET + or - button to set the minute. If you want to change the hour, press the RESET button.
- 5 Press the ENTER button.

- 3 Press the SET + or - button to set the hour, then press the ENTER button.
- NOTES:**
- After a power failure, disconnection of the power plug or turning the TV power off by pressing the POWER button on the front panel, the time display will be lost. In this case, set present time again.
 - When you set the minute, you can change in 10-minutes by holding down the SET + or - button.

COLOR SYSTEM

The color system is automatically selected, but if the picture is not clear or no color appears, select the color system manually.

- 1 Press the MENU button.
- 2 Press the SET + or - button to select the "COLOR" option then press the ENTER button.
- 3 Press the ENTER button to select the desired COLOR SYSTEM.
- 4 Press the MENU button.

TO MEMORIZE CHANNELS

This TV is equipped with a channel memory feature which allows channels to skip up or down to the next channel set into memory, skipping over unwanted channels. Before selecting channels, they must be programmed into the TV's memory. In addition to normal VHF and UHF channels, this TV can receive up to 113 Cable TV channels. To use this TV with an antenna, set the TV/CATV menu option to the TV setting. When shipped from the factory, this menu option is in the CATV setting.

TV/CATV SELECTION

- 1 Press the MENU button.
- 2 Press the SET + or - button until the indicator next to "CH SET UP" begins to flash, then press the ENTER button.
- 3 Press the SET + or - button until the indicator next to "TV/CATV" begins to flash.
- 4 Press the ENTER button to select the TV or CATV mode. The arrow indicates the selected mode.
- 5 Press the MENU button.

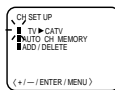

NOTE: Contact your cable company to determine the type of cable system used in your area.

AUTOMATIC CHANNEL MEMORY

- 1 Press the MENU button.
- 2 Press the SET + or - button until the indicator next to "CH SET UP" begins to flash, then press the ENTER button.
- 3 Press the SET + or - button until the indicator next to "AUTO CH MEMORY" begins to flash, then press the ENTER button. The TV will begin memorizing all the channels available in your area.

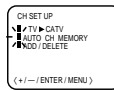

- 4 Press the MENU button.

TO ADD/DELETE CHANNELS

- 1 Press the MENU button.
- 2 Press the SET + or - button until the indicator next to "CH SET-UP" begins to flash, then press the ENTER button.
- 3 Press the SET + or - button until the indicator next to "ADD/DELETE" begins to flash, then press the ENTER button.
- 4 Select the desired channels to be added or deleted using the 10-key pad (0-9) or the CH + or - button.
- 5 Press the ENTER button to select ADD or DELETE. If an unmemorized channel was selected (step 4), the channel indication will be red. Press the CH + or - button if you wish to ADD the unmemorized channel. The channel indicator will change from red to green when a channel is added and the channel will be memorized. If a memorized channel was selected (step 4), the channel indication will be green. Press the CH + or - button if you wish to DELETE the channel from memory. The channel indicator will change from green to red when a channel is deleted. Repeat Steps 4 and 5 for each channel to be added or deleted.
- 6 Press the MENU button after adding or deleting all of the desired channels, to return to normal TV viewing.

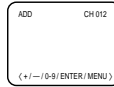
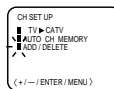

TV BASIC OPERATION

- 1 Press the POWER button on the front panel to put the TV into standby mode. The STAND BY indicator will light.
- 2 Press the POWER button on the remote control to turn on the TV. You can also turn on the TV by pressing the CHANNEL UP or DOWN button on the front panel or on the remote control when the TV is in standby mode.
- 3 The VOLUME can be adjusted to a desired level by pressing the VOL (VOLUME) > or < button. Adjust the volume level by pressing the VOL > or < button. The volume level will be indicated on the screen by green bar. As the volume level increases, so do the number of bar. If the volume decreases, the number of green bar also decreases.



The sound level will be indicated on the TV screen by green bars and a number. As the sound level increases, so do the number of bars and the number on the screen. The same is true for decreasing the level.

- 4 Set the TV/CATV menu option to the appropriate position. When shipped from the factory, this menu option is in the CATV setting. See "TO MEMORIZE CHANNELS".

TV - VHF/UHF channels
CATV - CABLE TV channels

- 5 **CH (CHANNEL) ^ and v buttons**
Press and release the CH (CHANNEL) ^ or v button. The channel automatically jumps at the next channel set into memory.



For proper operation, before selecting channels, they should be set into the TV's memory. See "TO MEMORIZE CHANNELS".

QUICK VIEW button

Returns to the channel viewed just before the channel currently onscreen.

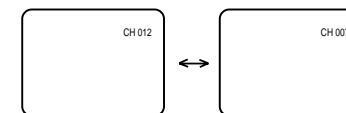

MUTING button

The MUTING button instantly turns the volume down completely when you press it. Press MUTING button and the volume level will instantly go to zero. To restore the volume to its previous level, press MUTING button again.

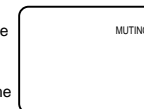

10-key pad (0-9)

Press these buttons to select a channel. The channel number will appear on the upper right corner of the TV screen. If an invalid channel number is selected, the display will revert to the original channel.

TV Mode Direct Channel Selection

When the TV/CATV menu option is in the TV position, all channels can be instantly selected by using two buttons. (For example, to select channel 2, press "0", then "2". If you press only "2", channel selection will be delayed for a few seconds). For channels 10 and above, press the 2 digits in order.

CATV Mode Direct Channel Selection

When the TV/CATV menu option is in the CATV position, channels can be selected as follows:

CH. 1-9	Press "0" twice, then 1-9 as needed. Example, to select channel 2, press "002".
CH. 10-12	Press "0", then remaining 2 digits. Example, to select channel 12, press "012".
CH. 13-99	Press the 2 digits in order. Example, to select channel 36, press "36".
CH. 100-125	Press the 3 digits in order. Example, to select channel 120, press "120".

NOTE: If the station being viewed stops broadcasting, the TV will automatically shut off after 15 minutes.

SLEEP TIMER button

The Sleep Timer can turn the TV off for you after you fall asleep. Program it to work in intervals of 10 minutes, for a total time of up to 120 minutes.

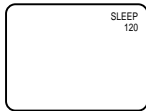

- To change the sleep timer setting: Press the SLEEP button repeatedly until the display turns to desired time.
- To cancel the sleep time: Press the SLEEP button repeatedly until the display turns to 0.

CALL button

Press the CALL button to display the current informations on the screen.

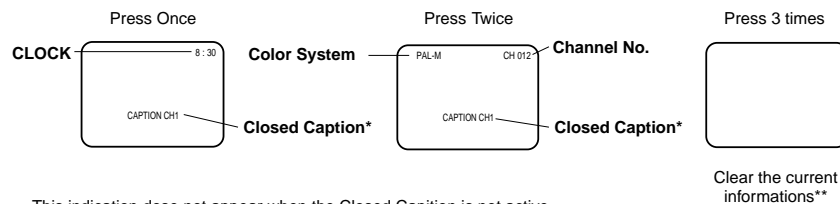

- * This indication dose not appear when the Closed Caption is not active.
- ** In the AV mode, "AV 1" or "AV 2" continues to display when there is no signal.

PICTURE ADJUSTMENTS

You can adjust the settings for color, sharpness, contrast, brightness, tint (NTSC only) and component.

- Press the MENU button.
- Press the SET + or – button until the indicator next to "PICTURE" begins to flash, then press the ENTER button.
- Press the ENTER button repeatedly to select the item you want to adjust.

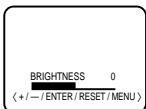
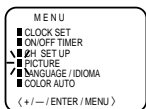

4 Press the SET + or – button to adjust the setting.

	+	-
BRIGHTNESS	increase brightness	decrease brightness
CONTRAST	increase contrast	decrease contrast
COLOR	be brilliant color	be pale color
TINT (NTSC only)	be greenish color	be reddish color
SHARPNESS	makes picture clearer	makes picture softer

TO RETURN TO INITIAL SETTING
Press the RESET button while the picture adjusting mode appears on the screen (except the adjusting component).

NOTE: The on-screen display will disappear 6 seconds after finishing an adjustment. The settings can only be adjusted when they are displayed on the TV screen.

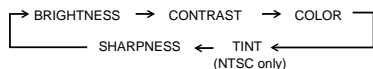

CLOSED CAPTION

WHAT IS CLOSED CAPTIONING?

This television has the capability to decode and display Closed Captioned television programs. Closed Captioning will display text on the screen for hearing impaired viewers or it will translate and display text in another language.

TO VIEW CLOSED CAPTIONS

Press the TV/CAP/TEXT button on the remote control to switch between normal TV and the two Closed Caption Modes (Captions and 1/2 of Full Screen Text).

Captions: This Closed Caption Mode will display text on the screen in English or another language (depending on the setting of the Closed Captions CH. 1/2 button). Generally, Closed Captions in English are transmitted on Captions Channel 1 and Closed Captions in other languages are transmitted on Captions Channel 2.

Text: The Text Closed Caption Mode will usually fill 1/2 of full screen with a programming schedule or other information. After selecting a Closed Caption Mode, it will stay in effect until it is changed, even if the channel is changed. If the Captions signal is lost due to a commercial or a break in the signal, the Captions will reappear when the signal is received again. If the channels are changed, the Captions will be delayed approximately 10 seconds. The Captions will appear in places on the screen where they will least interfere with the picture, usually on the bottom of the screen. News programs will usually show three-line Closed Captions which scroll onto the screen. Most other shows provide two or three lined Captions placed near the character who is speaking so the viewer can follow the dialogue. Words in italics or underlined describe titles, words in foreign languages or words requiring emphasis. Words that are sung usually appear enclosed by musical notes. For television programs broadcasting with Closed Captions, look in your TV guide for the Closed Captions symbol (CC).

- When activating the Closed Captioned Decoder, there will be a short delay before the Closed Captioned text appears on the screen.
- Closed Captioned text is only displayed in locations where it is available.
- If no caption signal is received, no captions will appear, but the television will remain in the Caption Mode.
- Misspellings or unusual characters may occasionally appear during Closed Captioning. This is normal with Closed Captioning, especially with live programs. This is because during live programs, captions are also entered live. These transmissions do not allow time for editing.
- When Captions are being displayed, on-screen displays, such as volume and MUTING may not be seen or may interfere with Closed Captions.
- Some cable systems and copy protection systems may interfere with the Closed Captioned signal.
- If using an indoor antenna or if TV reception is very poor, the Closed Caption Decoder may not appear or may appear with strange characters or misspelled words. In this case, adjust the antenna for better reception or use an outdoor antenna.

ON/OFF TIMER

ON TIMER SETTING

This feature allows you to have the TV automatically turn "ON" at predetermined time. If you program the "ON" timer once the timer will turn "ON" the TV daily at the same time and to the same channel. If the power has been turned on at programmed time, the channel is changed to a programmed one.

- 1 Press the MENU button.
- 2 Press the SET + or - button until the indicator next to "ON/OFF TIMER" begins to flash, then press the ENTER button.
- 3 Press the SET + or - button until the indicator next to "ON TIMER" begins to flash, then press the ENTER button.
- 4 Press the SET + or - button to set the hour, then press the ENTER button. If you want to change the hour, press the RESET button.
- 5 Press the SET + or - button to set the minute, then press the ENTER button.
 - You can change in 10-minutes step by holding down the SET + or - button.
- 6 Press the SET + or - button to set the channel, then press the ENTER button.
 - You can set the channel which is added in the CH SET UP option.
- 7 Press the SET + or - button to select the SET mode.
- 8 Press the MENU button.

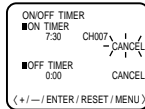
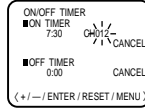
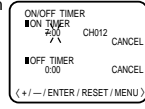
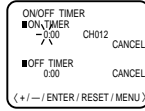
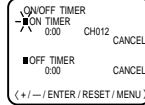

NOTES:

- You cannot set the ON/OFF TIMER when the clock is not set.
- This TV will automatically turn off approximately 1 hour later after the ON TIMER turns on the TV unless any buttons are pressed.
- To cancel the ON TIMER function:
To cancel ON TIMER in step 7 above press the SET + or - button to select the CANCEL mode.

OFF TIMER SETTING

This feature allows you to have the TV turn "OFF" automatically at a predetermined time. If you program the OFF TIMER once, The TV will be automatically turned off at the same time daily.

- 1 Press the MENU button.
- 2 Press the SET + or - button until the indicator next to "ON/OFF TIMER" begins to flash, then press the ENTER button.
- 3 Press the SET + or - button until the indicator next to "OFF TIMER" begins to flash, then press the ENTER button.
- 4 Press the SET + or - button to set the hour, then press the ENTER button. If you want to change the hour, press the RESET button.
- 5 Press the SET + or - button to set the minute then press the ENTER button.
 - You can change in 10-minutes step by holding down the SET + or - button.
- 6 Press the SET + or - button to select the SET mode.
- 7 Press the MENU button.

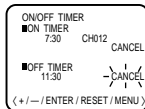
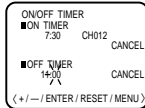
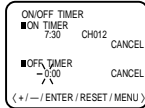
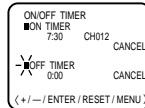
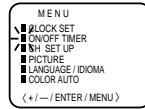

NOTES:

- If station being viewed stops broadcasting, the TV will automatically shut itself off after 15 minutes.
- To cancel the OFF TIMER function:
To cancel OFF TIMER, in step 7 above press the SET + or - button to select the CANCEL mode.

TROUBLESHOOTING GUIDE

Before requesting service, please refer to the following chart for the symptom and possible solution.

SYMPTOMS	POSSIBLE SOLUTIONS
TV does not operate	<ul style="list-style-type: none"> • Make sure the power cord is plugged in. • Try another AC outlet. • Power is off, check fuse or circuit breaker. • Unplug unit for an hour, then plug it back in.
Poor sound or No sound	<ul style="list-style-type: none"> • Station or CATV experiencing problems, tune to another station. • Check sound adjustments (Volume and Muting). • Check for sources of possible interference.
Poor picture or No picture	<ul style="list-style-type: none"> • Station or CATV experiencing problems, tune to another station. • Make sure channels are set into memory. • Check antenna or CATV connections, reorient antenna. • Check for sources of possible interference. • Check picture control adjustments.
Poor reception on some channels	<ul style="list-style-type: none"> • Station or CATV experiencing problems, tune to another station. • Make sure channels are set into memory. • Station signal is weak, reorient antenna to receive desired station. • Check for sources of possible interference.
Poor color or no color	<ul style="list-style-type: none"> • Station or CATV experiencing problems, tune to another station. • Make sure channels are set into memory. • Check picture control adjustments. • Check antenna or CATV connections, reorient antenna. • Check for sources of possible interference. • Check the color system.
Picture wobbles or drifts	<ul style="list-style-type: none"> • Station or CATV experiencing problems, tune to another station. • Make sure channels are set into memory. • CATV company is scrambling signal. • Check antenna orientation.
No CATV reception	<ul style="list-style-type: none"> • Check all CATV connections. • Set TV/CATV menu option to the CATV mode. • Station or CATV system problems, try another station.
Horizontal or diagonal bars on screen	<ul style="list-style-type: none"> • Check antenna connections, reorient antenna. • Check for sources of possible interference.
No reception above channel 13	<ul style="list-style-type: none"> • Make sure TV/CATV menu option is in the appropriate mode. • If using antenna, check UHF antenna connections.
No Remote operation	<ul style="list-style-type: none"> • Batteries are weak, dead or inserted incorrectly. • Remote is out of range, move closer to TV within (15 feet). • Make sure Remote is aimed at sensor. • Confirm there are no obstructions between the Remote and the TV. • Make sure the power cord is plugged in.
TV shuts off	<ul style="list-style-type: none"> • No broadcast on station tuned. • Sleep Timer is set. • ON/OFF TIMER is set. • Power interrupted. • Approximately 1 hour has passed after the ON TIMER turns on and no button was pressed (See page 14).
Closed - Caption is not activated.	<ul style="list-style-type: none"> • TV station experiencing problems or program tuned is not closed captioned. • Try another channel. • Check CATV connection or VHF/UHF antenna, reposition or rotate antenna. • Press TV/CAP/TEXT button to turn on the closed caption decoder.
Display is not shown in your language.	<ul style="list-style-type: none"> • Select proper language in the menu options.