



- ENGLISH
- DEUTSCH
- FRANÇAIS
- NEDERLANDS
- CASTELLANO
- ITALIANO
- PORTUGUÊS

# JVC

InteriArt *Natural Vision* **T-V LINK**

**AV32L2EU**  
**AV28L2EU**  
**AV32X10EU**  
**AV28X10EU**

*Natural Vision* **T-V LINK**  
**AV28WH5EU**

**COLOUR TELEVISION** **INSTRUCTIONS**

FARBFERNSEHGERÄT  
 TELEVISEUR COULEUR  
 KLEURENTELEVISIE  
 TELEVISOR A COLOR  
 TELEVISORE A COLORI  
 TELEVISOR A CORES

BEDIENUNGSANLEITUNG  
 MANUEL D'INSTRUCTIONS  
 GEBRUIKSAANWIJZING  
 MANUAL DE INSTRUCCIONES  
 ISTRUZIONI  
 INSTRUÇÕES

AV32L2EU / AV28L2EU / AV32X10EU / AV28X10EU / AV28WH5EU

JVC

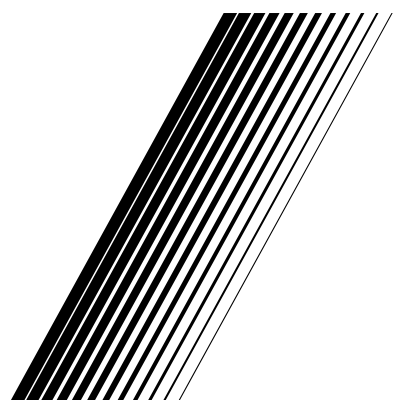

**JVC**  
 VICTOR COMPANY OF JAPAN, LIMITED

Thank you for buying this JVC colour television.

To make sure you understand how to use your new TV, please read this manual thoroughly before you begin.

**WARNING:**

*TO PREVENT FIRE OR SHOCK HAZARD, DO NOT EXPOSE THIS APPLIANCE TO RAIN OR MOISTURE.*

**CAUTION:**

*TO ENSURE PERSONAL SAFETY, OBSERVE THE FOLLOWING RULES REGARDING THE USE OF THIS UNIT.*

1. Operate only from the power source specified (AC 220 – 240 V, 50 Hz) on the unit.
2. Avoid damaging the AC plug and power cord.
3. Avoid improper installation and never position the unit where good ventilation is unattainable.

*When installing this television, distance recommendations must be maintained between the floor and wall, as well as installation in a tightly enclosed area or piece of furniture. Adhere to the minimum distance guidelines shown for safe operation.*

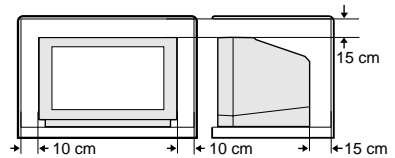

4. Do not allow objects or liquid into the cabinet openings.
5. In the event of a fault, unplug the unit and call a service technician. Do not attempt to repair it yourself or remove the rear cover.
6. The surface of the TV screen is easily damaged. Be very careful with it when handling the TV. Should the TV screen become soiled, wipe it with a soft dry cloth. Never rub it forcefully. Never use any cleaner or detergent on it.
7. The main power button on the TV does not fully isolate the TV from the AC supply. If you are not going to use this TV for a long period of time, be sure to disconnect the AC plug from the AC socket.

**CONTENTS**

PREPARATION . . . . .	2
T-V LINK FUNCTIONS . . . . .	5
BASIC OPERATION . . . . .	6
REMOTE CONTROL BUTTONS AND FUNCTIONS . . . . .	9
MENU OPERATION . . . . .	14
PICTURE SETTING. . . . .	15
PICTURE FEATURES. . . . .	16
SOUND SETTING . . . . .	18
EXT SETTING . . . . .	19
FEATURES . . . . .	21
INSTALL . . . . .	23
DEMO . . . . .	27
ADDITIONAL MENU OPERATIONS . . . . .	28
ADDITIONAL PREPARATION. . . . .	31
CH/CC NUMBER. . . . .	33
TV BUTTONS AND PARTS. . . . .	34
TROUBLESHOOTING. . . . .	35
SPECIFICATIONS. . . . .	37

# PREPARATION

## ■ Connecting the Aerial and VCR

If connecting a VCR, follow (A) → (B) → (C) .  
If not connecting a VCR, follow ①.

To operate T-V LINK functions, a T-V LINK compatible VCR must be connected to the EXT-2 terminal on the TV. For details about T-V LINK functions, see "T-V LINK FUNCTIONS" on page 5.

### Note:

- For further details, refer to the manuals provided with the devices to be connected.
- The connecting cables are not provided.
- A video can be viewed from the VCR without performing (C). For details, refer to your VCR instruction manual.
- To connect additional external devices, please see "ADDITIONAL PREPARATION" on page 31.
- To connect speakers and amplifier, please see "Connecting Speakers/Amplifier (Excluding AV28WH5EU)" on page 32.
- When a decoder is connected to a T-V LINK compatible VCR, set the DECODER (EXT-2) function to ON. For details, see "Using the DECODER (EXT-2) function" on page 29. Otherwise, you will not be able to view scrambled channels.

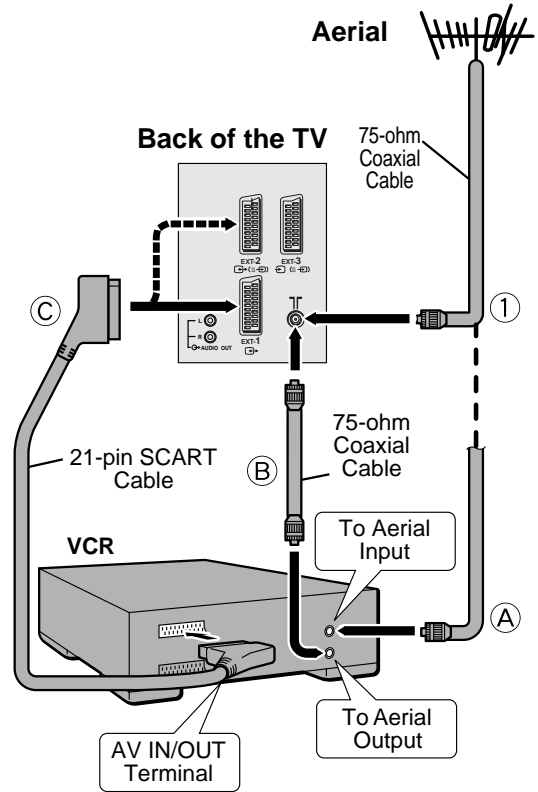

## ■ Connecting the power cord to the AC outlet

### Caution:

- Operate only from the power source specified (AC 220 – 240 V, 50 Hz) on the unit.

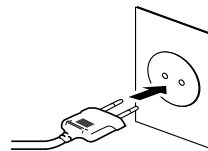

## ■ Putting Batteries into the Remote Control

Use two AAA/R03 dry cell batteries.

Insert the batteries from the ⊖ end, making sure the ⊕ and ⊖ polarities are correct.

To open the battery compartment, slide the door downwards and lift off. Replace the door by sliding it upwards until it is secure.

### Note:

- Follow the warnings printed on the batteries.
- Battery life is about six months to one year, depending on your frequency of use.
- If the remote control does not work properly, replace the batteries.
- The batteries we supply are only for setting up and testing your TV, please replace them as soon as necessary.
- Always use good quality batteries.

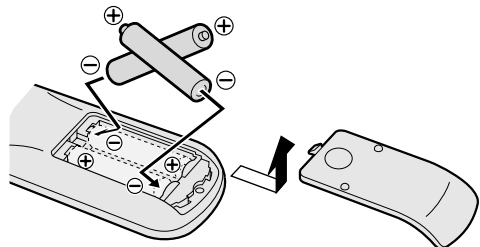

## Initial Settings

When the TV is first turned on, it enters the initial setting mode, and the JVC logo is displayed. Follow the instructions on the on-screen display to make the initial settings.

### 1 Press the Main power button on the TV.

The Power lamp lights red (for power on), then green (for TV on) and the JVC logo is displayed.

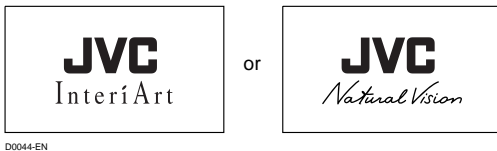

D0044-EN

#### Note:

- If the power lamp stays red and does not change to green:  
Your TV is in the standby mode. Press the  $\odot/|$  (Standby) button on the remote control to turn your TV on.
- The JVC logo does not appear when your TV has been turned on once.  
In this case, use the "LANGUAGE" and "AUTO PROGRAM" functions to make the initial settings. For details, see "INSTALL" on page 23.

< AV32L2EU/AV28L2EU >

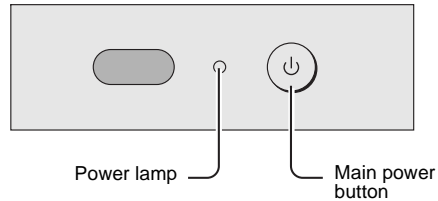

< AV32X10EU/AV28X10EU >

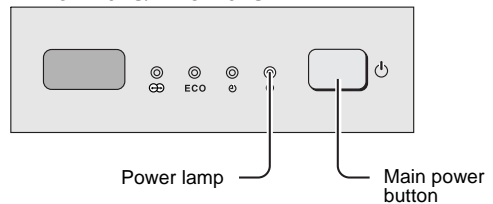

< AV28WH5EU >

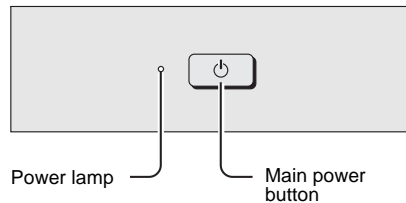

### 2 Press the OK button.

The LANGUAGE menu appears.

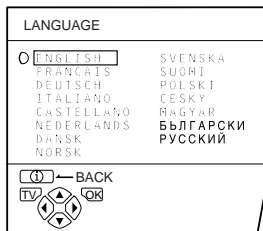

D0002(E)-EN

### 3 Press the $\leftarrow/\rightarrow$ and $\nabla/\blacktriangle$ buttons to choose ENGLISH. Then press the OK button.

English is set for the on-screen display description. The COUNTRY menu appears as a sub-menu of the AUTO PROGRAM function.

There are two COUNTRY menus. Pressing the yellow button changes the COUNTRY menu as follows:

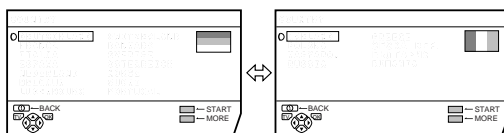

D0003-EN

### 4 Press the $\leftarrow/\rightarrow$ and $\nabla/\blacktriangle$ buttons to choose the country where you are now located.

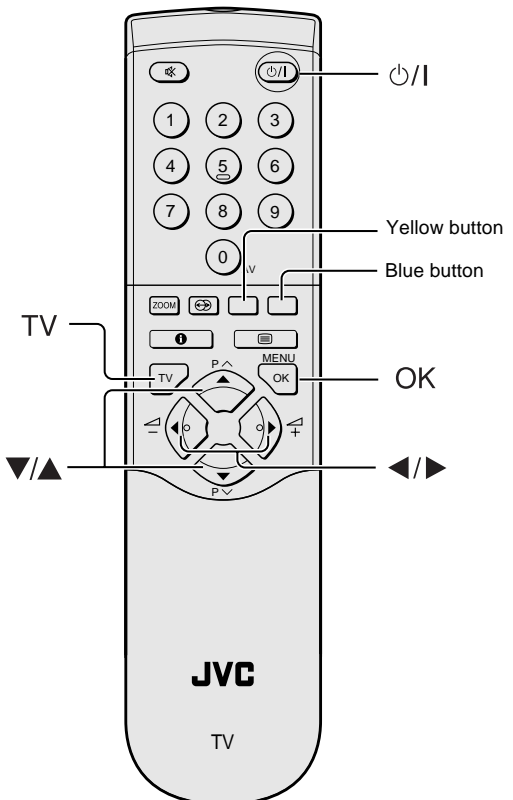

**5 Press the blue button to start the AUTO PROGRAM function.**

The AUTO PROGRAM menu appears and received TV channels are automatically registered in the Programme numbers (PR).

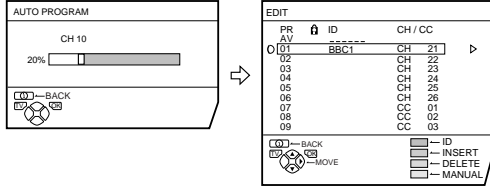

D0004-EN

**If “ACI START/ACI SKIP” appears in the AUTO PROGRAM menu:**

You can use the ACI (Automatic Channel Installation) function to decode the ACI data and complete the registration of all the TV channels in a short period of time. For details of the ACI function and how to use it, refer to “Using the ACI function” on page 28.

If you don’t want to use the ACI function, press the ▼/▲ button to choose ACI SKIP and then press **OK**.

**To cancel the AUTO PROGRAM function:**

Press the **TV** button.

**6 After the TV channels have been registered in the Programme numbers (PR), the EDIT menu appears.**

You can proceed to edit the Programme numbers (PR) using the EDIT/MANUAL function. For details, see “EDIT/MANUAL” on page 24.

**When not using the EDIT/MANUAL function:**

If you do not need to use the EDIT/MANUAL function, go to the next step.

**7 Press the OK button to display the T-V LINK menu.**

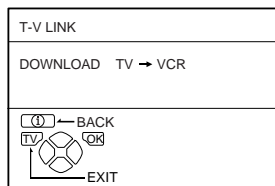

D0005-EN

**8 Operate the T-V LINK menu according to the type of a VCR connected to the EXT-2 terminal.**

**When a T-V LINK compatible VCR is not connected:**

Press the **TV** button to exit the T-V LINK menu.

The T-V LINK menu disappears.

**When a T-V LINK compatible VCR is connected:**

Follow the operating procedure “Downloading the data to VCR” on page 28 to transmit the Programme number (PR) data.

**9 Now, the initial settings are complete, and you can watch the TV.**

**Note:**

- When your TV can detect the TV channel name from the TV channel broadcast signal, it automatically registers the TV channel name (ID) to the Programme number (PR) in which the TV channel has been registered.
- If a TV channel you want to view is not set to a Programme number (PR), manually set it using the MANUAL function. For details, see “EDIT/MANUAL” on page 24.
- The TV channel is not registered in Programme number PR 0 (AV). When you want to register a TV channel to PR 0 (AV), manually set it using the MANUAL function. For details, see “EDIT/MANUAL” on page 24.

# T-V LINK FUNCTIONS

---

When a T-V LINK compatible VCR is connected to the EXT-2 Terminal on the TV, it is easier to set up the VCR and to view videos. T-V LINK uses the following features:

## To use T-V LINK functions:

A T-V LINK compatible VCR is necessary.

The VCR must be connected to the EXT-2 terminal on the TV by a fully wired SCART cable.

### Note:

- A "T-V LINK compatible VCR" means a JVC VCR with the T-V LINK logo or a VCR with one of the following logos. However, these VCRs may support some or all of the features described below. For details, refer to your VCR instruction manual.

"Q-LINK" (a trademark of Panasonic Corporation)

"Data Logic" (a trademark of Metz Corporation)

"Easy Link" (a trademark of Phillips Corporation)

"Megalogic" (a trademark of Grundig Corporation)

"SMARTLINK" (a trademark of Sony Corporation)

## ■ Pre-set Download

Download the registered data on the TV channels from the TV to the VCR.

The Preset Download function automatically begins when the initial setting is complete or whenever the AUTO PROGRAM or EDIT/MANUAL operations are performed.

### Note:

- This function can be operated via VCR operation.

### When "FEATURE NOT AVAILABLE" is displayed:

If "FEATURE NOT AVAILABLE" is displayed, the download was not performed correctly. Before trying to download again, ensure the following:

- The VCR power is turned on.
- The VCR is T-V LINK compatible.
- The VCR is connected to the EXT-2 terminal.
- The SCART cable is fully wired.

## ■ Direct Rec

"What You See Is What You Record"

You can record to VCR the images that you are currently viewing on TV by a simple operation.

For details, read the manual for your VCR.

Operate via the VCR. "VCR IS RECORDING" is displayed.

**In the following conditions, the VCR will stop recording if the TV is turned off, if the TV channel or input is switched, or if the menu is displayed on the TV:**

- When recording images from an external device connected to the TV.
- When recording a TV channel after it has been unscrambled on a decoder.
- When recording a TV channel by using the TV's output because that TV channel cannot be properly received on the VCR's tuner.

### Note:

- Operation via the TV is not possible.
- Generally, the VCR cannot record a TV channel that cannot be received properly by the VCR's tuner, even though you can view that TV channel on the TV. However, some VCRs can record a TV channel by using the TV's output if that channel can be viewed on the TV, even though the TV channel cannot be received properly by the VCR's tuner. For details, refer to your VCR instruction manual.

## ■ TV Auto Power On/VCR Image View

When the VCR starts playing, the TV automatically turns on and the images from EXT-2 terminal are displayed on the screen.

When the VCR menu is operated, the TV automatically turns on and the images from EXT-2 terminal are displayed on the screen.

### Note:

- This function does not operate if your TV's main power is turned off. Set your TV's main power to on (standby mode).



**2 Press the ◀/▶ and ▼/▲ buttons to choose a Programme number (PR). Then press the OK button.**

**Note:**

- For Programme numbers (PR) with the CHILD LOCK function set, the **⏸** (CHILD LOCK) mark is displayed next to the Programme number (PR) in the PR LIST.
- You cannot use the ▼/▲ buttons to choose a Programme number (PR) with the CHILD LOCK function set.
- Even if you try to choose a Programme number (PR) with the CHILD LOCK function set, the **⏸** (CHILD LOCK) mark will appear, and you cannot watch the TV channel. To watch the TV channel, see "CHILD LOCK" on page 21.
- If you do not have a clear picture or no colour appears, change the colour system manually. See "COLOUR SYSTEM" on page 17.
- If the picture is tilted, correct it. See "PICTURE TILT (Excluding AV28WH5EU)" on page 17.

## ■ Adjust the volume

**Press the ◀/▶ buttons to adjust the volume.**

The Volume indicator appears and the volume changes as you press the -/+ buttons.

## ■ Watch images from external devices

Choose an EXT terminal to which the desired external device has been connected.

**Use the 0 (AV) button:**

Press the **0 (AV)** button to choose an EXT terminal.

Pressing the **0 (AV)** button changes the choice as follows:

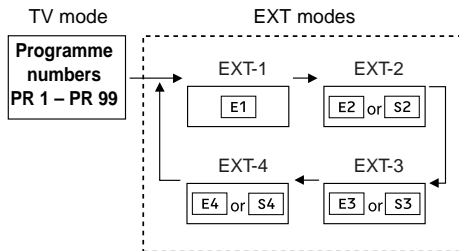

**Use the ▼/▲ buttons:**

Press the ▼/▲ buttons to choose an EXT terminal.

**Use the PR LIST:**

- 1 Press the **i** (Information) button to display the PR LIST.**
- 2 Press the ◀/▶ and ▼/▲ buttons to choose an EXT terminal. Then press the OK button.**

**Note:**

- The EXT terminals are registered after the Programme number PR 99.
- You can choose a video input signal from the S-VIDEO signal (Y/C signal) and regular video signal (composite signal). For details, see "S-IN (S-VIDEO input)" on page 19.
- If you do not have a clear picture or no colour appears, change the colour system manually. See "COLOUR SYSTEM" on page 17.
- When choosing an EXT terminal with no input signal, the EXT terminal number becomes fixed on the screen.
- This TV set has a function which can automatically change over the input according to a special signal output from an external device. (The EXT-4 terminal does not support it.)

**To return to a TV channel:**

Press the **TV** button, the ▼/▲ buttons or the Number buttons.

**To use the Programme number PR 0 (AV):**

When the TV and VCR are connected only by the Aerial cable, choosing the Programme number PR 0 (AV) allows you to view images from the VCR. Set the VCR RF channel to the Programme number PR 0 (AV) manually. For details, see "EDIT/MANUAL" on page 24.

Pressing the **0 (AV)** button changes the choice as follows:

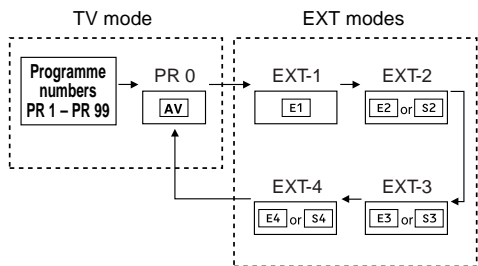

**Note:**

- The VCR RF channel is sent as the RF signal from the VCR.
- Also refer to your VCR instruction manual.



## ■ Operating with the buttons on the TV

**1** Press the P  $\nabla/\wedge$  buttons to turn the TV on from standby mode.

**2** Press the P  $\nabla/\wedge$  buttons to choose a Programme number (PR) or an EXT terminal.

**3** Press the  $\triangleleft$  (Volume) button and the  $-/+$  buttons to adjust the volume.

**1** Press the  $\triangleleft$  (Volume) button.

The volume level indicator appears.

**2** Press the  $-/+$  buttons while the volume level indicator is displayed.

< AV32L2EU/AV28L2EU >  
Side of the TV

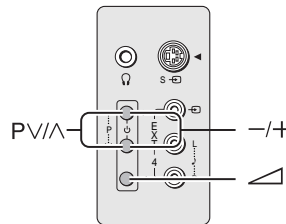
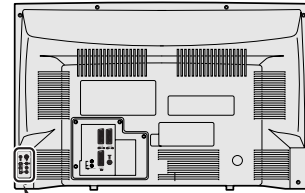

< AV32X10EU/AV28X10EU >  
Behind the Cover

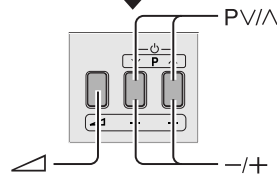
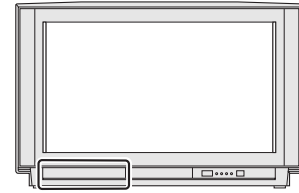

< AV28WH5EU >  
Behind the Cover

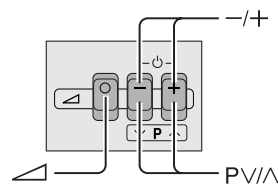
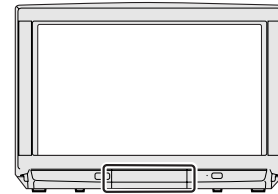

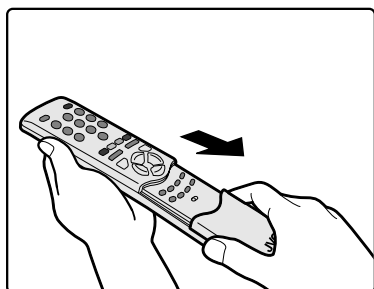
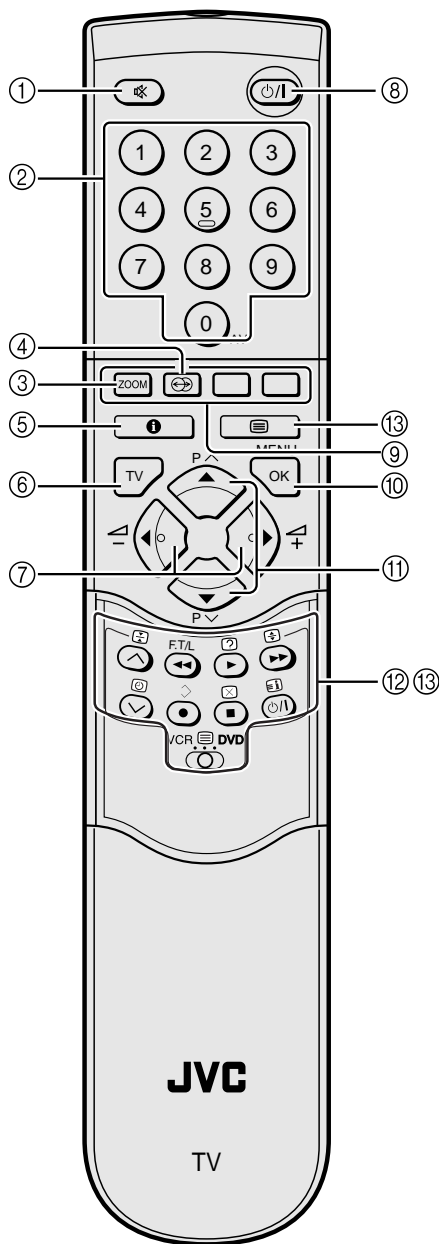

# REMOTE CONTROL BUTTONS AND FUNCTIONS



## ① Muting Button

You can turn the volume off instantly.

Press the  (Muting) button to turn off the Volume. Pressing the  (Muting) button again resumes the previous Volume level.

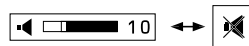

## ② Number Buttons

You can choose a Programme number (PR) by entering the Programme number.

Example:

- PR 12 → press 1 and 2.
- PR 6 → press 6.

You can also press the 0 (AV) button repeatedly to choose an EXT terminal.

## ③ ZOOM Button

You can change the screen size according to the picture aspect ratio. Choose the optimum one from the following ZOOM modes.

### AUTO:

For any picture format except Normal Picture (4:3 Aspect Ratio), the picture will be automatically displayed in the optimum screen size.

For Normal Picture (4:3 Aspect Ratio), the picture displayed in accordance with the ZOOM mode set on the 4:3 AUTO ASPECT menu. For details, see "4:3 AUTO ASPECT" on page 17.

### Note:

- AUTO may not function properly with poor signal quality. In this case, choose an optimum ZOOM mode manually.
- This TV supports WSS (wide-screen signals). When broadcasts with WSS are received with the ZOOM mode set at AUTO, the most suitable ZOOM mode is automatically chosen according to the WSS received.

### REGULAR:

Use to view a normal picture (4:3 aspect ratio) as its original size is.



### PANORAMIC:

This mode stretches the left and right sides of a normal picture (4:3 Aspect Ratio) to fill the screen, without making the picture appear unnatural.

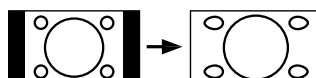

### Note:

- The top and bottom of the picture are slightly cut off.

**14:9 ZOOM:**

This mode zooms up the Wide Picture (14:9 Aspect Ratio) to the upper and lower limits of the screen.

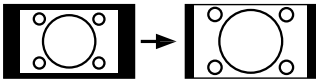

**16:9 ZOOM:**

This mode zooms up the Wide Picture (16:9 Aspect Ratio) to the full screen.

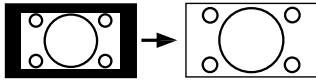

**16:9 ZOOM SUBTITLE:**

This mode zooms up the Wide Picture (16:9 Aspect Ratio) with subtitles to the full screen.



**FULL:**

This mode uniformly stretches the left and right sides of a normal picture (4:3 aspect ratio) to fill the wide TV screen.

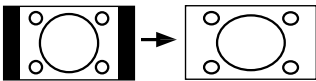

**Note:**

- Use for pictures with a 16:9 aspect ratio that have been squeezed into a normal picture (4:3 aspect ratio), you can restore their original dimensions.

**Choose the ZOOM mode**

- 1 Press the ZOOM button to display the ZOOM menu.

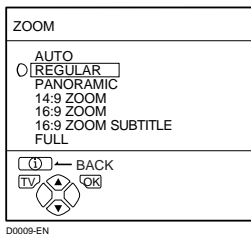

- 2 Press the ▼/▲ buttons to choose a ZOOM mode. Then press the OK button.

The picture expands and the chosen ZOOM mode is displayed in about 5 seconds.

**Note:**

- The ZOOM mode may be automatically changed due to the control signal from an external device. When you want to return to the previous ZOOM mode, choose the ZOOM mode again.

**Adjusting the visible area of the picture**

If subtitles or the top (or bottom) of the picture are cut off, adjust the visible area of the picture manually.

- 1 Press the ZOOM button.

The ZOOM menu appears.

- 2 Press the OK button to display the ZOOM mode indication.

Indicator is displayed.

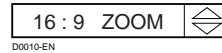

- 3 While it is displayed, press the ▼/▲ buttons to adjust the visible area vertically.

**Note:**

- You cannot adjust the visible area in REGULAR or FULL mode.

**4 HYPER SOUND Button**

You can enjoy sounds with a wider ambience.

Press the  (HYPER SOUND) button to turn the HYPER SOUND function on or off.

**Note:**

- The HYPER SOUND function does not work properly with mono sound.
- The HYPER SOUND function can be also turned on or off by using the SOUND SETTING menu. For details, see "HYPER SOUND" on page 18.

### ⑤ Information Button

You can display the PR LIST or the Current Time on the screen.

Press the **i** (Information) button.

Pressing the **i** (Information) button changes the display as follows:

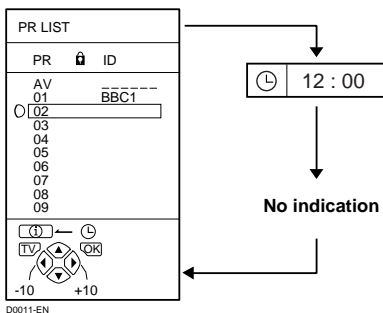

**Note:**

- You can choose Programme numbers (PR) or EXT terminals with the PR LIST. For details, see “Use the PR LIST:” on page 6.
- This TV uses teletext data to set the current time. If the TV has not received a TV channel that has teletext programmes since it was turned on, the time display is blank. To view the current time, choose a TV channel that has teletext programmes. The time will still be displayed as long as you do not turn off the TV, even if you choose other TV channels.
- When watching videos, an incorrect current time is sometimes displayed.
- The **i** (Information) button is also used to operate menus. For details, see “MENU OPERATION” on page 14.

### ⑥ TV Button

You can return to a TV channel instantly.

Press the **TV** button.

The TV returns to the TV mode and a TV channel appears.

**Note:**

- The **TV** button is also used to operate menus. For details, see “MENU OPERATION” on page 14.

### ⑦ ◀▶ Buttons

You can adjust the volume.

Press the **◀▶** buttons to adjust the sound.

**Note:**

- The **◀▶** buttons are also used to operate menus. For details, see “MENU OPERATION” on page 14.

### ⑧ Standby Button

Press the **⏻/⏪** (Standby) button to turn the TV on or off.

When the TV is turned on, the power lamp changes from red to green.

### ⑨ Colour Buttons

The colour buttons are used for the teletext operations or the menu operations. For details, see “⑬ Teletext Control Buttons and VCR **⏻** DVD Switch” on page 12 or “MENU OPERATION” on page 14.

### ⑩ OK Button

The **OK** button is used to operate menus. For details, see “MENU OPERATION” on page 14.

### ⑪ ▼▲ Buttons

You can choose a Programme number (PR) or an EXT terminal.

Press the **▼▲** buttons to choose an Programme number (PR) or an EXT terminal.

The **▼▲** buttons are also used to operate menus. For details, see “MENU OPERATION” on page 14.

### ⑫ VCR/DVD Control Buttons and VCR **⏻** DVD Switch

These buttons can be used to operate a JVC brand VCR or DVD player. Pressing the button having the same appearance as the original remote control button of a device makes the function work in the same way as the original remote control.

#### 1 Set the VCR **⏻** DVD Switch to the VCR or DVD position.

**VCR:**

When you are operating the VCR, set the switch to the VCR position.

**DVD:**

When you are operating the DVD player, set the switch to the DVD position.

#### 2 Press the VCR/DVD Control Button to control your VCR or DVD player.

**Note:**

- If your device is not made by JVC, these buttons cannot be used.
- Even if your device is made by JVC, some of these buttons or any one of the buttons may not work, depending on the device.
- You can use the **V/Λ** buttons to choose a TV channel. The VCR will receive or choose the chapter the DVD player plays back.
- Some DVD player models use the **V/Λ** buttons for both operating of Fast forward/backward functions and choosing the chapter. In this case, the **◀▶** buttons do not work.

## 13 Teletext Control Buttons and VCR DVD Switch

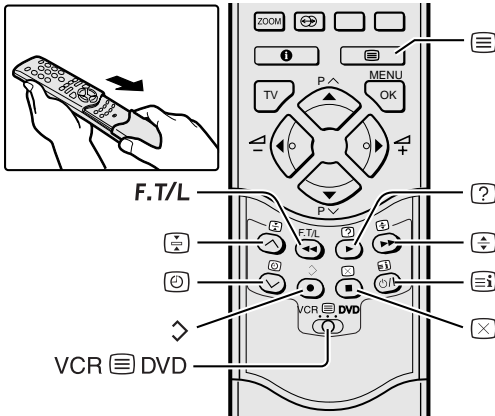

4 Choose a teletext page by pressing the ▼/▲ buttons, Number buttons or Colour buttons.

**To return to the TV mode:**

Press the **TV** button or (Text) button.

**Note:**

- If you have trouble receiving teletext broadcasts, consult your local dealer or the teletext station.
- The ZOOM function will not operate in the TV and text mode or Text mode.
- No menu operations are possible when viewing a teletext programme.
- Language display depends on the country which was set on the COUNTRY menu. If characters on a Teletext programme do not appear properly, change the COUNTRY Setting to other country's. For detail, "Changing the COUNTRY setting" on page 28.

### Basic operation

You can view three types of teletext broadcasts on the TV: FLOF (Fastext), TOP and WST.

- 1 Choose a TV channel with a teletext broadcast.
- 2 Set the VCR DVD switch to the (Text) position.



- 3 Press (Text) button to display the teletext.

Pressing (Text) button changes the mode as follows:

<Excluding AV28WH5EU>

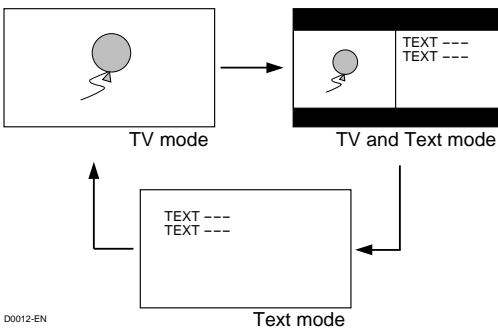

D0012-EN

<AV28WH5EU>

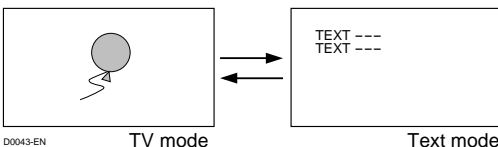

D0043-EN

### Using the List Mode

You can store the numbers of your favourite teletext pages in memory and call them up quickly using the colour buttons.

**To store the page numbers:**

- 1 Press **F.T/L** button to engage the List mode.

The stored page numbers are displayed at the bottom of the screen.

- 2 Press a **Colour** button to choose a position. Then press the **Number** buttons to enter the page number.

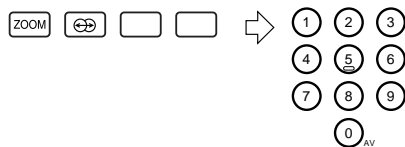

- 3 Press and hold down (Store) button.

The four page numbers blink white to indicate that they are stored in memory.

**To call up a stored page:**

- 1 Press the **F.T/L** button to engage the List mode.

- 2 Press a **colour** button to which a page has been assigned.



**To exit the List mode:**

Press the **F.T/L** button again.

## Hold

You can hold a teletext page on the screen for as long as you want, even while several other teletext pages are being received.

Press the  (Hold) button.

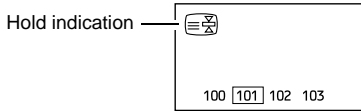

To cancel the Hold function:

Press  (Hold) button again.

## Sub-page

Some teletext pages include sub-pages that are automatically displayed.

You can hold any sub-page, or view it at any time.

1 Press the  (Sub-page) button to operate the Sub-page function.

Sub-page numbers are displayed at the left of the screen.

Colour*	Meaning of sub-page number
Yellow	Currently being displayed.
White	Can be displayed.
Blue or Red	Cannot be displayed and it is not sent.

\*: Background color of the sub-page number.

2 Press the / buttons to choose a sub-page number.

To cancel the Sub-page function:

Press the  (Sub-page) button again.

## Reveal

Some teletext pages include hidden text (such as answers to a quiz).

You can display the hidden text.

Each time you press the  (Reveal) button, text is hidden or revealed.

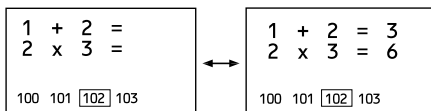

## Size

You can double the height of the teletext display.

Press the  (size) button.

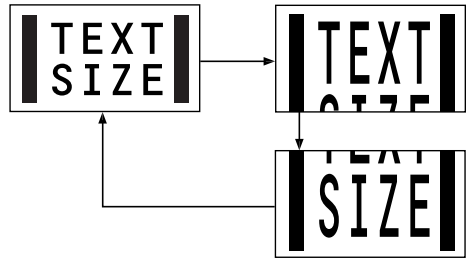

## Index

You can return to the index page instantly.

Press the  (Index) button.

**FLOF (Fasttext)/TOP/WST:**

Returns to page 100 or a previously specified page.

**List mode:**

Returns to the page number displayed in the lower left area of the screen.

## Cancel

You can search for a teletext page while watching TV.

1 Press the Number button to enter a page number, or press a Colour button.

The TV searches for a teletext page.

2 Press the  (Cancel) button.

The TV programme appears. When the TV finds the teletext page, its page number appears in the upper left of the screen.

3 Press the  (Cancel) button to return to a teletext page when the page number is on the screen.

**Note:**

- The TV mode cannot be resumed even by pressing the  (Cancel) button. A TV programme is temporarily displayed instead of the teletext programme.

# MENU OPERATION

This TV has a number of functions you can operate using menus. To fully utilize all your TV's functions, you need to understand the basic menu operating techniques fully.

## 1 Press the OK button to display the MENU (main menu).

The MENU (main menu) appears. In it, the titles of the menus are displayed.

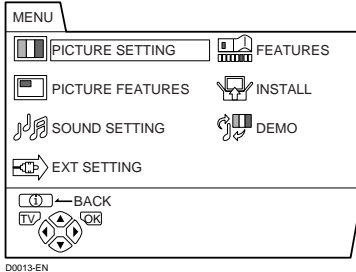

## 2 Press the ▼/▲ buttons to choose a menu title, and press the OK button.

The menu appears.

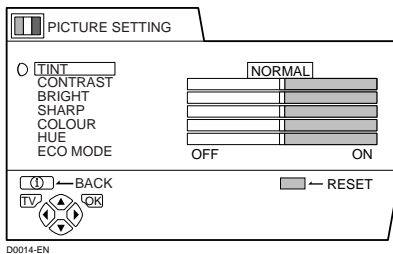

## 3 Operate the menus according to the operation description of each function.

### Note:

- For details, refer to the operation descriptions of each function described for each menu which follows this "MENU OPERATION".
- The display appearing at the bottom of a menu indicates a button on the remote controller you can use when you operate a chosen function.

## 4 Press OK button to complete the setting.

The menu disappears.

### To return to the previous menu:

Press **i** (information) button.

### To exit a menu instantly:

Press the **TV** button.

### Note:

- When watching the television with the NTSC system, the menus are displayed at about half of their normal vertical size.
- When a menu is displayed on the screen, the ZOOM mode may be automatically changed to the FULL mode. This is not a malfunction. When the menu disappears, the ZOOM mode will return to the previously set ZOOM mode.

# PICTURE SETTING

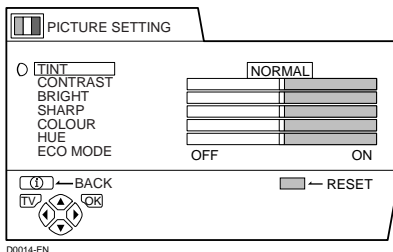

To display the **PICTURE SETTING** menu:

- 1 Press the **OK** button to display **MENU** (main menu).
- 2 Press the **▼/▲** button to choose **PICTURE SETTING**, and press the **OK** button.

## ■ TINT

You can select one of three TINT modes (three kinds of picture settings) to adjust the picture settings automatically.

- 1 Press the **▼/▲** buttons to choose **TINT**.
- 2 Press **◀/▶** buttons to choose a mode.

### **COOL:**

A cool white colour base with a boost in the colour and contrast levels that creates a more vivid picture.

### **WARM:**

A warm orange/red colour base that creates the appropriate colour and contrast levels for watching films.

### **NORMAL:**

A normal white colour base with normal colour and contrast levels.

- 3 Press the **OK** button to complete the setting.

The menu disappears.

## ■ Picture Adjustment

You can change the picture settings of each TINT mode as you like.

The picture settings changed are stored in the TINT mode.

- 1 Press the **▼/▲** buttons to choose an item.
- 2 Press the **◀/▶** buttons to change the setting.

◀	Item	▶
Lower	<b>CONTRAST</b> (picture contrast)	Higher
Darker	<b>BRIGHT</b> (picture brightness)	Brighter
Softer	<b>SHARP</b> (picture sharpness)	Sharper
Lighter	<b>COLOUR</b> (picture colour)	Deeper
Reddish	<b>HUE</b> (picture hue)	Greenish

### **Note:**

- You can change the **HUE** setting (picture hue) only when the colour system is **NTSC 3.58** or **NTSC 4.43**.

### **To return to the default settings in each TINT mode:**

Press the blue button.

Returns the picture settings in the currently chosen TINT mode to the default settings, and stores them in the TINT mode again.

- 3 Press the **OK** button to complete the settings.

The menu disappears.

## ■ ECO MODE

When you set the **ECO MODE** function to **ON**, the screen contrast is automatically adjusted to a setting suitable for the brightness of your room. This reduces eye strain for you and the power consumption of the TV.

- 1 Press **▼/▲** buttons to choose **ECO MODE**.
- 2 Press **◀/▶** buttons to choose **ON**.

### **To cancel the ECO MODE function:**

Press **◀/▶** buttons to choose **OFF**.

- 3 Press the **OK** button to complete the setting.

The menu disappears.



# PICTURE FEATURES

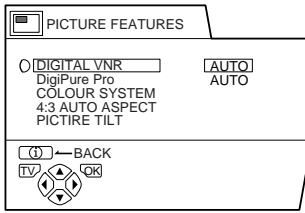

00015-EN

To display the **PICTURE FEATURES** menu:

- 1 Press the **OK** button to display **MENU** (main menu).
- 2 Press the **▼/▲** button to choose **PICTURE FEATURES**, and press the **OK** button.

## DIGITAL VNR

The **DIGITAL VNR** function cuts down the amount of noise in the original picture.

You can choose from the three **DIGITAL VNR** function settings of **AUTO**, **MIN** and **MAX**.

### Note:

- If you set the **DIGITAL VNR** effect too high it can make the picture less sharp. It is recommended to use the **AUTO** setting if you can.

- 1 Press the **▼/▲** buttons to choose **DIGITAL VNR**.
- 2 Press the **◀/▶** buttons to choose a setting.

### AUTO:

The TV will automatically adjust the level of the **DIGITAL VNR** effect to match the amount of noise in the picture, giving you the best possible picture.

### MIN:

The level of the **DIGITAL VNR** effect is set to the minimum. If you set the **DIGITAL VNR** function to **AUTO** but feel that the sharpness of the original picture has not been reproduced fully, change the setting from **AUTO** to **MIN**.

- The **MIN** setting is not suitable for low-quality pictures which contain a lot of noise.

### MAX:

The level of the **DIGITAL VNR** effect is set to the maximum. If you set the **DIGITAL VNR** function to **AUTO** but still notice some noise, change the setting from **AUTO** to **MAX**.

- The **MAX** setting is not suitable for high-quality pictures which contain very little noise.

- 3 Press the **OK** button to complete the setting.

The menu disappears.

## DigiPure Pro (Excluding AV28WH5EU)

The **DigiPure Pro** function uses the latest in digital technology to give you a natural looking picture. The **DigiPure Pro** function includes the following two functions.

### DigiPure function:

This function helps to create a natural looking picture by eliminating unnecessary edges from high-contrast and crisp images. Conversely, for images with low-contrast, edges are added to produce a sharper, more detailed picture.

You can choose from the three **DigiPure** function settings of **AUTO**, **MIN** and **MAX**.

### Note:

- If you set the **DigiPure** effect too high on a low-quality picture that contains a lot of noise, this may actually make the noise worse. It is recommended to use the **AUTO** setting if you can.

### Picture motion compensation function:

This function displays fast-moving pictures (for example, the players or ball in a football game) more smoothly and naturally on the screen.

### Note:

- The effect level of the picture motion compensation function cannot be changed. The effect level is the same no matter which of the **AUTO**, **MIN** or **MAX** settings is used.

- 1 Press the **▼/▲** buttons to choose **DigiPure Pro**.
- 2 Press the **◀/▶** buttons to choose a setting.

### AUTO:

The TV will automatically adjust the level of the **DigiPure** effect to match the amount of noise in the picture, giving the best possible picture.

### MIN:

The level of **DigiPure** effect is set to the minimum. When you set the **DigiPure Pro** function to **AUTO** and notice some noise, change the setting from **AUTO** to **MIN**.

- The **MIN** setting is not suitable for high-quality pictures which contain very little noise.

### MAX:

The level of **DigiPure** effect is set to the maximum. If you set the **DigiPure Pro** function to **AUTO** but feel that the original picture quality has not been reproduced fully, change the setting from **AUTO** to **MAX**.

- The **MAX** setting is not suitable for low-quality pictures which contain a lot of noise.

### OFF:

The **DigiPure Pro** function is turned off.

- 3 Press the **OK** button to complete the setting.

The menu disappears.

## ■ COLOUR SYSTEM

The colour system is chosen automatically. However, if the picture is not clear or no colour appears, choose the colour system manually.

- 1 Press the **▼/▲** buttons to choose **COLOUR SYSTEM**. Then press the **OK** button.

The Sub-menu of the COLOUR SYSTEM function appears.

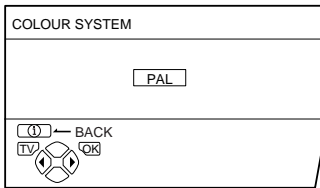

D0016-EN

- 2 Press the **◀/▶** buttons to choose the appropriate colour system.

**PAL:**

PAL system

**SECAM:**

SECAM system

**NTSC 3.58:**

NTSC 3.58 MHz system

**NTSC 4.43:**

NTSC 4.43 MHz system

**AUTO:**

This function detects a colour system from the input signal. Only when you are viewing a picture from Programme number PR 0 (AV), or EXT terminal, you can choose using the AUTO function.

- 3 Press the **OK** button to complete the setting.

The menu disappears.

**Note:**

- The AUTO function may not function properly if you have poor signal quality. If the picture is abnormal in the AUTO function, choose another colour system manually.
- When in the Programme numbers PR 0 (AV) to PR 99, you cannot choose NTSC 3.58 or NTSC 4.43.

## ■ 4:3 AUTO ASPECT

You can choose one of three ZOOM modes, REGULAR, PANORAMIC or 14:9 ZOOM, as the ZOOM mode for the normal picture (4:3 aspect ratio).

- 1 Press the **▼/▲** buttons to choose **4:3 AUTO ASPECT**. Then press the **OK** button.

The Sub-menu of the 4:3 AUTO ASPECT function appears.

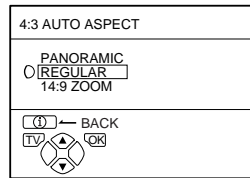

D0017-EN

- 2 Press the **▼/▲** buttons to choose a ZOOM mode.

- 3 Press the **OK** button to complete the settings.

The menu disappears.

## ■ PICTURE TILT (Excluding AV28WH5EU)

There are cases where the Earth's magnetic force may make the picture tilt. If this happens, you can correct the picture tilt.

- 1 Press the **▼/▲** buttons to choose **PICTURE TILT**. Then press the **OK** button.

The Sub-menu of the PICTURE TILT function appears.

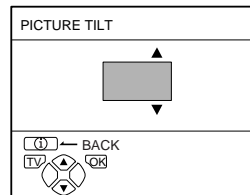

D0018-EN

- 2 Press the **▼/▲** buttons until the picture becomes level.

- 3 Press the **OK** button to complete the setting.

The menu disappears.

# SOUND SETTING

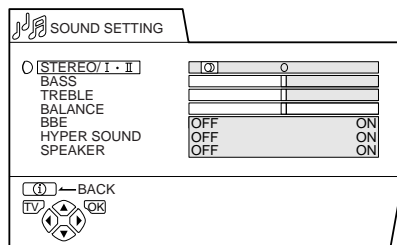

To display the **SOUND SETTING** menu:

- 1 Press the **OK** button to display **MENU** (main menu).
- 2 Press the **▼/▲** button to choose **SOUND SETTING**. Then press the **OK** button.

## ■ STEREO / I·II

When you are viewing a bilingual broadcast programme, you can choose the sound from Bilingual I (Sub I) or Bilingual II (Sub II). When the stereo broadcasting is received poorly, you can change from stereo to mono sound so that you can hear the broadcast more clearly and easily.

- 1 Press the **▼/▲** buttons to choose **STEREO / I·II**.
- 2 Press the **◀/▶** buttons to choose a sound mode.

- ◐ : Stereo sound
- : mono sound
- I : Bilingual I (sub I)
- II : Bilingual II (sub II)

- 3 Press the **OK** button to complete the setting.

The menu disappears.

### Note:

- The sound mode you can choose differs depending on the TV programme.
- This function does not work in the **EXT** modes. And this function does not appear in the **SOUND SETTING** menu.

## ■ Sound Adjustment

You can adjust the sound to your liking.

- 1 Press the **▼/▲** buttons to choose an item.
- 2 Press the **◀/▶** buttons to adjust it.

◀	Item	▶
Weaker	<b>BASS</b>	Stronger
Weaker	<b>TREBLE</b>	Stronger
Left	<b>BALANCE</b>	Right

- 3 Press the **OK** button to complete the setting.

The menu disappears.

## ■ SPEAKER (Excluding AV28WH5EU)

You can turn off the sound from the TV speakers; but you should only do this if an audio system is connected to the TV as a substitute for the TV speakers. When you are using this function, see "Setting the **SPEAKER** function (Excluding AV28WH5EU)" on page 30.

**When a sound is not issued from the TV speaker:**  
If the **SPEAKER** function is set to **OFF**, the TV speaker does not issue sound. Press the **▼/▲** buttons to choose the **SPEAKER**. Then press the **◀/▶** buttons to choose **ON**.

## ■ BBE (Excluding AV28WH5EU)

You can use the **BBE** function to enjoy easy-to-listen sound that is faithful to the original sound recorded.

- 1 Press the **▼/▲** buttons to choose **BBE**.
- 2 Press the **◀/▶** buttons to choose **ON**.

### To cancel the **BBE** function:

Press the **◀/▶** buttons to choose **OFF**.

- 3 Press the **OK** button to complete the setting.

The menu disappears.

- Licensed by **BBE Sound, Inc.** **BBE** is a registered trademark of **BBE Sound, Inc.**

## ■ HYPER SOUND

You can enjoy sounds with a wider ambience.

- 1 Press the **▼/▲** buttons to choose **HYPER SOUND**.

- 2 Press the **◀/▶** buttons to choose **ON**.

### To cancel the **HYPER SOUND** function:

Press the **◀/▶** buttons to choose **OFF**.

- 3 Press the **OK** button to complete the setting.

The menu disappears.

### Note:

- The **HYPER SOUND** function does not work properly with mono sound.
- You can turn on or off the **HYPER SOUND** function with a single press. For details, see "④ **HYPER SOUND** Button" on page 10.

# EXT SETTING

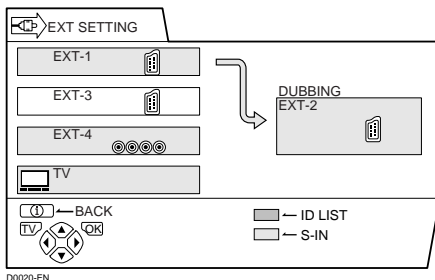

To display EXT SETTING menu:

- 1 Press the **OK** button to display MENU (main menu).
- 2 Press the **▼/▲** button to choose EXT SETTING. Then press the **OK** button.

## ■ S-IN (S-VIDEO input)

When connecting a device (such as S-VHS VCR) which enables an S-VIDEO signal (Y/C signal) to be output, you can enjoy high-quality picture of the S-VIDEO signal (Y/C signal).

### Preparation:

- At first, read the Device Instruction Manual and "ADDITIONAL PREPARATION" on page 31 to connect the device to the TV properly. Second, follow the Device Instruction Manual to set the device so that a S-VIDEO signal (Y/C signal) can be output to the TV.
- Do not set S-IN (S-VIDEO input) to the EXT terminal connected to a device which cannot output a S-VIDEO (Y/C signal). If it is set wrongly, a picture cannot appear.

- 1 Press the **▼/▲** buttons or **◀/▶** buttons to choose an EXT terminal.
- 2 Press the yellow button and set the S-IN (S-VIDEO input).

A **S** (S-VIDEO input) mark is displayed. You can view an S-VIDEO signal (Y/C signal) instead of the regular video signal (composite signal).

### To cancel the S-IN (S-VIDEO input) setting:

Press the yellow button and turn off **S** (S-VIDEO input) mark. The regular video signal (composite signal) pictures are resumed.

- 3 Press the **OK** button to complete the setting.

The menu disappears.

### Note:

- The EXT-1 terminal does not support S-VIDEO signal (Y/C signal) and you cannot set S-IN (S-VIDEO input) in the EXT-1 terminal.
- Setting S-IN (S-VIDEO input) changes the head character from "E" to "S". For example, "E2" is changed to "S2".
- Even an device which enables the S-VIDEO signal (Y/C signal) to be output may output a regular video signal (composite signal) depending on the device setting. If a picture cannot appear because S-IN (S-VIDEO input) setting has been made, read the device Instruction Manual carefully again to check for the device settings.

## ■ ID LIST

You can have a name corresponding to the devices connected for each EXT terminal. Giving a name to an EXT terminal makes the EXT terminal number appear on the screen, together with the name.

- 1 Press the **▼/▲** buttons or **◀/▶** buttons to choose an EXT terminal.
- 2 Press the blue button to display the name list (ID LIST).

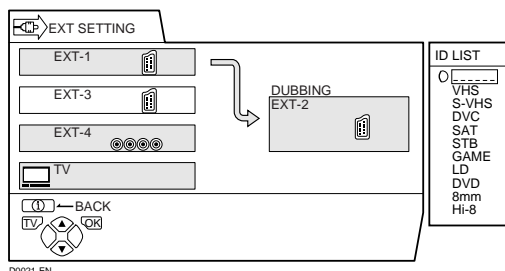

- 3 Press the **▼/▲** buttons to choose a name. Then press the **OK** button.

The ID LIST disappears and the name is assigned to the EXT terminal.

### To erase a name assigned to the EXT terminal:

Choose a blank space.

- 4 Press the **OK** button to complete the setting.

The menu disappears.

### Note:

- You cannot assign an EXT terminal name not found in the name list (ID LIST).

## ■ DUBBING

You can choose a signal source to be output from an EXT-2 terminal.

You can choose any one of the output signal of the device connected to the EXT terminal and the picture and sound from a TV channel you are currently viewing to output it to the EXT-2 terminal.

### 1 Press the ◀/▶ buttons to choose the arrow from the menu.

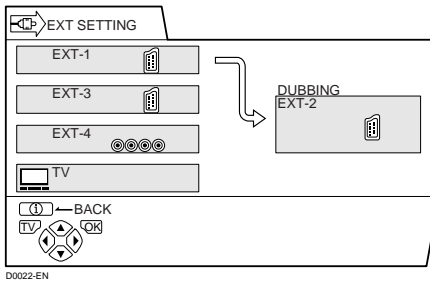

### 2 Press the ▼/▲ buttons to choose an EXT terminal or TV.

The arrow in the menu represents a signal flow. The left side of the arrow denotes a signal source output from the EXT-2 terminal.

#### **EXT-1/EXT-3/EXT-4:**

The output signal of the device connected to an EXT terminal passes through the TV and is output from the EXT-2 terminal.

#### **TV:**

The picture and sound of the TV channel you are currently viewing are output from the EXT-2 terminal.

### 3 Press the OK button to complete the setting.

The menu disappears.

#### **Note:**

- During dubbing, you cannot turn off the TV. Turning off the TV also turns off the output from the EXT-2 terminal.
- When you choose an EXT terminal as an output, you can view a TV programme or a picture from the other EXT terminal while dubbing the picture from a device connected to the EXT terminal onto a VCR connected to the EXT-2 terminal.
- The RGB signals from the TV games cannot be output. Teletext programmes cannot be output.

# FEATURES

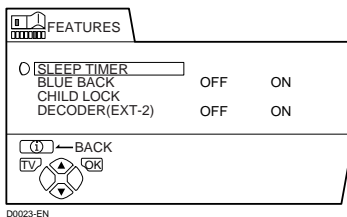

To display the **FEATURES** menu:

- 1 Press the **OK** button to display **MENU** (main menu).
- 2 Press the **▼/▲** button to choose **FEATURES**. Then press the **OK** button.

## ■ SLEEP TIMER

You can set the TV to automatically turn off after a specified period of time.

- 1 Press the **▼/▲** buttons to choose **SLEEP TIMER**. Then press the **OK** button.

A Sub-menu of the **SLEEP TIMER** function appears.

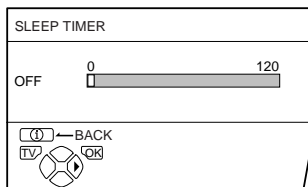

- 2 Press the **◀/▶** buttons to set the period of time.

You can set the period of time a maximum of 120 minutes (2 hours) in 10 minute increments.

**To cancel the SLEEP TIMER function:**

Press the **◀** button to set a period of time to "OFF."

- 3 Press the **OK** button to complete the settings.

The menu disappears.

### Note:

- One minute before the **SLEEP TIMER** function turns off the TV, "GOOD NIGHT!" appears.
- The **SLEEP TIMER** function cannot be used to turn off the TV's main power.
- When the **SLEEP TIMER** function is on, you can display the Sub-menu of the **SLEEP TIMER** function again to confirm and/or change the remaining period of time of the **SLEEP TIMER** function. Press the **OK** button to exit the menu after confirming and / or changing the remaining time.

## ■ BLUE BACK

You can set the TV to automatically change to a blue screen and mute the sound if the signal is weak or absent, or when there is no input from an external device.

- 1 Press the **▼/▲** buttons to choose **BLUE BACK**.
- 2 Press the **◀/▶** buttons to choose **ON**.

**To cancel the BLUE BACK function:**

Press the **◀/▶** buttons to choose **OFF**.

- 3 Press the **OK** button to complete the setting.

The menu disappears.

## ■ CHILD LOCK

When there is a TV channel you wish your children not to watch, you can use the **CHILD LOCK** function to lock out the TV channel. Even when a child chooses a Programme number (PR) in which a locked TV channel has been registered, the screen will change to blue and displays **⏏** (**CHILD LOCK**) so the TV channel cannot be viewed. Unless you enter a pre-set ID number by a special operation, the lock cannot be released and the child cannot view the TV channel programmes.

### To set the CHILD LOCK function

- 1 Press the **▼/▲** buttons to choose **CHILD LOCK**. Then press the **0 (AV)** button.

"SET ID NO." (ID number setting screen) appears.

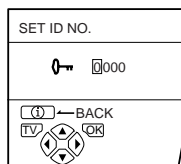

- 2 Set the ID number to your liking.

- 1 Press the **▼/▲** buttons to choose a number.
- 2 Press the **◀/▶** buttons to move the cursor.

- 3 Press the **OK** button.

The Sub-menu of **CHILD LOCK** appears.

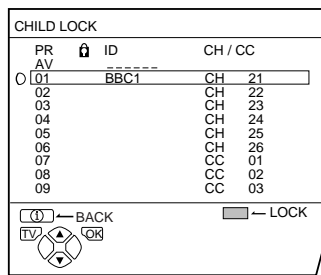

**4 Press the ▼/▲ buttons to choose a TV channel.**

Every time you press the ▼/▲ buttons, the Programme number (PR) changes, and the picture of the TV channel registered in the Programme number (PR) is displayed on the screen.

**5 Press the blue button and set the CHILD LOCK function.**

🔒 (CHILD LOCK) appears and the TV channel is locked.

**To reset the CHILD LOCK function:**

Press the blue button again.

🔒 (CHILD LOCK) disappears.

**6 Press the OK button to complete the setting.**

The menu disappears.

**Note:**

- To disable easy resetting of the CHILD LOCK function, the menu disappears by choosing the CHILD LOCK function and pressing the OK button as in the ordinary menu operation.

**To view a locked TV channel**

**1 Choose a Programme number (PR) in which a TV channel locked with the Number buttons or PR LIST.**

The screen changes to blue and the 🔒 (CHILD LOCK) appears. You cannot view the TV channel.

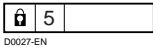

**2 Press the ⓘ (Information) button to display "ID NO." (ID NO. input screen).**

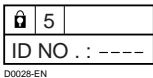

**3 Press the Number buttons to enter the ID number.**

The lock is temporarily released so you can view the TV channel.

**If you have forgotten the ID number:**

Perform step 1 of "To set the CHILD LOCK function". After confirming the ID number, press the TV button to exit the menu.

**Note:**

- Even if you reset the lock temporarily, it does not mean that the CHILD LOCK function set for the TV channel is cancelled. The next time anyone attempts to view the TV channel, it will be locked again.
- When you would like to cancel the CHILD LOCK function, you must perform the operation "To set the CHILD LOCK function" again.
- To disable easy choosing of a Programme number (PR) in which a locked TV channel has been registered, the Programme number (PR) has been set that it cannot be chosen by the ▼/▲ buttons or the operation buttons at the TV.
- To disable easy resetting of the lock, "ID NO." (ID NO. input screen) is set so that it cannot appear unless you press the ⓘ (Information) button.

**■ DECODER (EXT-2)**

Only when connecting a Decoder with a T-V LINK compatible VCR connected to the EXT-2 terminal, you can use this function. To operate this function, see "Using the DECODER (EXT-2) function" on page 29.

**Caution:**

- If you have not connected a Decoder with a T-V LINK compatible VCR connected to the EXT-2 terminal, setting this function to "ON" by mistake causes the picture/sound of a TV channel you are currently viewing not to be issued.

# INSTALL

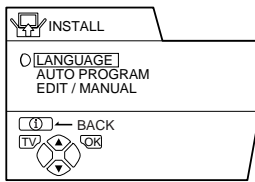

D0029-EN

To display the **INSTALL** menu:

- 1 Press the **OK** button to display **MENU** (main menu).
- 2 Press the **▼/▲** button to choose the **INSTALL** menu. Then press the **OK** button.

## LANGUAGE

You can choose the language you want to use for the on-screen display from the language list in a menu.

- 1 Press the **▼/▲** buttons to choose **LANGUAGE**. Then press the **OK** button.

A sub-menu of the **LANGUAGE** function appears.



D0002(E)-EN

- 2 Press the **◀/▶** and **▼/▲** buttons to choose a language.
- 3 Press the **OK** button to complete the setting.

The menu disappears.

## AUTO PROGRAM

You can automatically register the TV channels which can be received well at your residence in the TV's Programme numbers (PR) by performing the following.

- 1 Press the **▼/▲** buttons to choose **AUTO PROGRAM**. Then press the **OK** button.

The **COUNTRY** menu appears as a sub-menu of the **AUTO PROGRAM** function.

There are two **COUNTRY** menus. Pressing the yellow button changes the **COUNTRY** menu as follows:

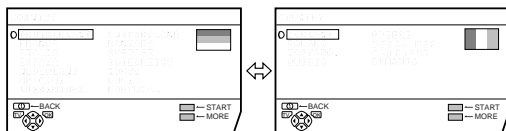

D0003-EN

- 2 Press the **◀/▶** and **▼/▲** buttons to choose the country where you are now located.

- 3 Press the **blue** button to start the **AUTO PROGRAM** function.

The **AUTO PROGRAM** menu appears and received TV channels are automatically registered in the Programme numbers (PR).

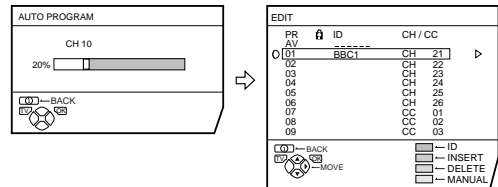

D0004-EN

If "**ACI START/ACI SKIP**" appears in the **AUTO PROGRAM** menu:

You can use the **ACI** (Automatic Channel Installation) function to decode the **ACI** data and complete the registration of all the TV channels in a short period of time. For details of the **ACI** function and how to use it, refer to "Using the **ACI** function" on page 28.

If you don't want to use the **ACI** function, press the **▼/▲** buttons to choose **ACI SKIP** and then press **OK**.

To cancel the **AUTO PROGRAM** function:

Press the **TV** button.

- 4 After the TV channels have been registered in the Programme numbers (PR), the **EDIT** menu appears.

You can proceed to edit the Programme numbers (PR) using the **EDIT/MANUAL** function. For details, see "**EDIT/MANUAL**" on page 24.

When not using the **EDIT/MANUAL** function:

If you do not need to use the **EDIT/MANUAL** function, go to the next step.

- 5 Press the **OK** button to display the **T-V LINK** menu.

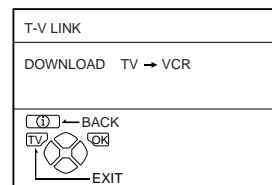

D0005-EN

- 6 Operate the **T-V LINK** menu according to the type of **VCR** connected to the **EXT-2** terminal.

When a **T-V LINK** compatible **VCR** is not connected:

Press the **TV** button to exit the **T-V LINK** menu.

The **T-V LINK** menu disappears, and all the settings are completed.

When a **T-V LINK** compatible **VCR** is connected:

Follow the operating procedure "Downloading the data to **VCR**" on page 28 to transmit the Programme number (PR) data to the **VCR**.



**Note:**

- When your TV can detect the TV channel name from the TV channel broadcast signal, it automatically registers the TV channel name (ID) to the Programme number (PR) in which the TV channel has been registered.
- If a TV channel you want to view is not set to a Programme number (PR), manually set it using the MANUAL function. For details, see "EDIT/MANUAL" on page 24.
- The TV channel is not registered in Programme number PR 0 (AV). When you want to register a TV channel to PR 0 (AV) manually set it using the MANUAL function. For details, see "EDIT/MANUAL" on page 24.

## ■ EDIT/MANUAL

The EDIT/MANUAL functions are divided into two types: editing of the current Programme numbers (PR) (EDIT functions) and manual registration of a TV channel you want to view to the Programme number (PR) (MANUAL function). The details about these functions are as follows:

**MOVE:**

This function changes a Programme number (PR) of a TV channel.

**ID:**

This function registers a Channel name (ID) to a TV channel.

**INSERT:**

This function adds a new TV channel in the current Programme numbers (PR) list by using the CH/CC number.

**DELETE:**

This function deletes a unnecessary TV channel.

**MANUAL:**

This function manually registers a new TV channel in a Programme number (PR).

**Caution:**

- Using the MOVE, DELETE or INSERT function rewrites the current Programme numbers (PR) list. Resultingly, the Programme number (PR) of some of the TV channels will change.
- Using the MANUAL function for a TV channel for which the CHILD LOCK function has been set cancels the CHILD LOCK function for the TV channel.
- Using the MANUAL function for a TV channel for which the DECODER (EXT-2) function has been set to ON returns the setting of the DECODER (EXT-2) function for the TV channel to OFF.
- When a TV channel has already been registered in PR 99, using the INSERT function deletes the TV channel.

**Note:**

- For Programme number PR 0, "AV" appears in the Programme numbers (PR) list.
- An EXT terminal number does not appear in the Programme numbers (PR) list.
- The CH/CC number is a number unique to the TV and corresponding to the Channel number of a TV channel. For the relationship of a Channel number and a CH/CC number, see "CH/CC NUMBER" on page 33.
- You cannot use the INSERT function if you do not know a Channel number of a TV channel. Use the MANUAL function to register a TV channel in the Programme number (PR).

- 1 Press the ▼/▲ buttons to choose EDIT/MANUAL. Then press the OK button.

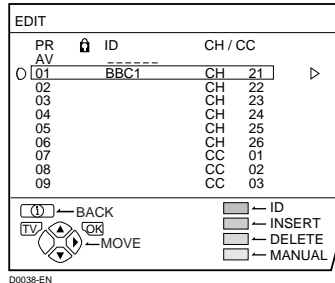

- 2 Follow the operation description of a function you want to use and operate the function.

- 3 Press the OK button to complete the settings.

The T-V LINK menu appears.

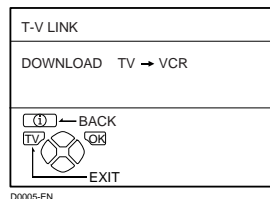

- 4 Operate the T-V LINK menu according to the type of VCR connected to the EXT-2 terminal.

**When a T-V LINK compatible VCR is not connected:**

Press the TV button to exit the T-V LINK menu.

The T-V LINK menu disappears and all the settings are completed.

**When a T-V LINK compatible VCR is connected:**

Follow the operating procedure "Downloading the data to VCR" on page 28 to transmit the Programme number (PR) data to the VCR.

## MOVE

- 1 Press the ▼/▲ buttons to choose a TV channel.

Every time you press the ▼/▲ buttons, the Programme number (PR) is changed over, and the picture of the TV channel registered in the Programme number (PR) appears on the screen.

- 2 Press the ► button to start the MOVE function.**

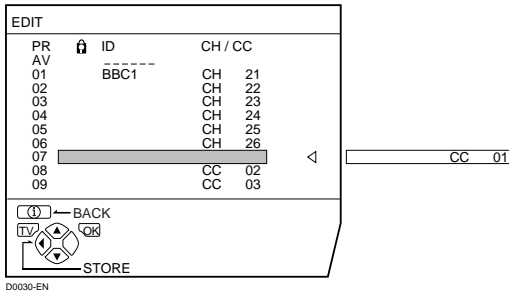

- 4 Press the blue button to display the ID LIST (channel name list).**

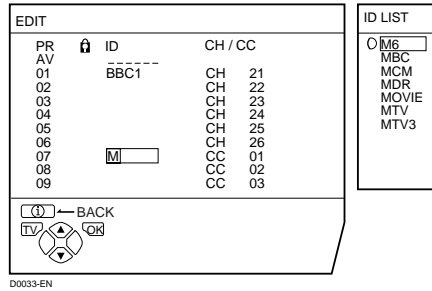

- 3 Press the ▼/▲ buttons to choose a new Programme number (PR).**

**To cancel the MOVE function:**

Press the ⓘ (Information) button.

- 4 Press the ◀ button to change the Programme number (PR) of a TV channel to a new Programme number (PR).**

## ID

- 1 Press the ▼/▲ buttons to choose a TV channel.**

Every time you press the ▼/▲ buttons, the Programme number (PR) is changed over, and the picture of the TV channel registered in the Programme number (PR) appears on the screen.

- 2 Press the red button to start the ID function.**

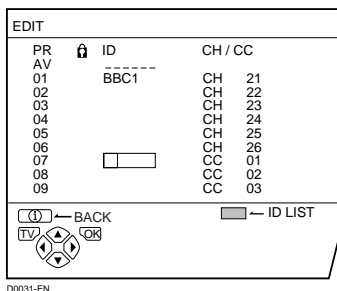

- 3 Press the ▼/▲ buttons to choose the first character of a Channel name (ID) you want to attach to the TV channel.**

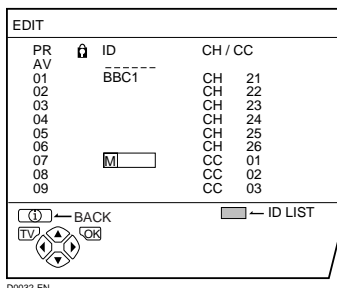

- 5 Press the ▼/▲ buttons to choose the Channel name (ID).**

**To cancel the ID function:**

Press the ⓘ (Information) button.

- 6 Press the OK button to register a Channel name (ID) to a TV channel.**

**Note:**

- You can register your unique Channel name (ID) to the TV channel. When step 3 is completed, do not go to step 4, but press the ◀/▶ buttons to move the cursor and the ▼/▲ buttons to choose a character for completing the Channel name (ID). Then press the OK button to register the Channel name (ID) to the TV channel.

## INSERT

**Preparation:**

- A CH/CC number unique to this TV and corresponding to the Channel number of a TV channel is required. Find the corresponding CH/CC number from a table "CH/CC NUMBER" on page 33 based on the Channel number of the TV channel.
- When the COUNTRY setting is not FRANCE, use a two-digit CH/CC number. When the COUNTRY setting is FRANCE, use a three-digit CH/CC number.
- Only when you add a TV channel (SECAM-L system) from a French station, be sure to set COUNTRY to FRANCE. If the COUNTRY setting is not FRANCE, follow the description "Changing the COUNTRY setting" on page 28 to change the COUNTRY setting to FRANCE, then start the INSERT function.

- 1 Press the ▼/▲ buttons to choose a Programme number (PR) for which you will register a new TV channel.**

**2 Press the green button and start the INSERT function.**

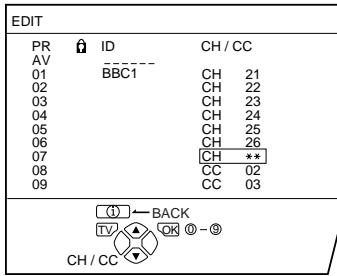

D0034-EN

**3 Press the ▼/▲ buttons to choose “CC” or “CH” according to the CH/CC number of the TV channel.**

**When the COUNTRY setting is FRANCE:**

Choose “CH1”, “CH2”, “CC1” or “CC2”.

**To cancel the INSERT function:**

Press the (i) (Information) button.

**4 Press the Number buttons to enter the remaining CH/CC number.**

The TV shifts to registration mode.

When the registration is completed, the picture of the TV channel appears on the screen.

**Note:**

- The CH/CC number is a number indicating the broadcast frequency to the TV. If the TV cannot detect the TV channel corresponding to the broadcast frequency indicated by the CH/CC number, a picture in the no-signal state appears.

**DELETE**

**1 Press the ▼/▲ buttons to choose a TV channel.**

Every time you press the ▼/▲ buttons, the Programme number (PR) is changed over, and the picture of the TV channel registered in the Programme number (PR) appears on the screen.

**2 Press the yellow button to delete the TV channel.**

The TV channel is deleted from the Programme numbers (PR) list.

**MANUAL**

**Preparation:**

- As long as you register the TV channel (SECAM-L system) from a French station, be sure to set the COUNTRY setting to FRANCE. If the COUNTRY setting is not FRANCE, follow the description “Changing the COUNTRY setting” on page 28 to change the COUNTRY setting to FRANCE, then start the MANUAL function.

**1 Press the ▼/▲ buttons to choose a Programme number (PR) to which you want to register a new TV channel.**

**2 Press the blue button to activate the MANUAL function.**

At the right side following the CH/CC number, the SYSTEM (broadcasting system) of the TV channel appears.

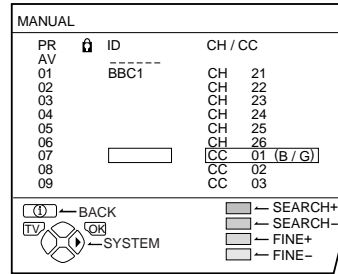

D0035-EN

**To cancel the MANUAL function:**

Press the (i) (Information) button.

**3 Press the ► button to choose the SYSTEM (broadcasting system) for a TV channel you want to register.**

**TV channel (SECAM-L system) from a French station:**

Set the SYSTEM to “L”. If it is set to one other than “L”, you cannot receive the TV channel of the SECAM-L system.

**Other TV channels:**

If you do not know the correct broadcasting system, set the SYSTEM to “B/G”. If “B/G” is not correct, it results in the fact that you will not hear the sound normally when the TV detects a TV channel. In this case, retry to set the SYSTEM again correctly so that no problem arises.

**4 Press the green or red button to search for a TV channel.**

Scanning stops when the TV finds a TV channel. Then the TV channel is displayed.

**5 Press the green or red button repeatedly until the TV channel you want appears.**

**If the TV channel reception is poor:**

Press the blue or yellow button to fine-tune the TV channel.

**If you cannot hear the normal sound even when the picture of the TV channel appears normally:**

The SYSTEM setting is wrong. Press the ► button and choose a SYSTEM that has normal sound.

**6 Press the OK button and register the TV channel to a Programme number (PR).**

The normal EDIT menu is resumed.

# DEMO

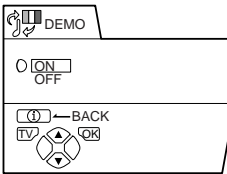

*To display the DEMO menu:*

- 1 Press the OK button to display MENU (main menu).**
- 2 Press the ▼/▲ button to choose DEMO. Then press the OK button.**

The DEMO function automatically demonstrates some of the TV functions.

- 1 Press the ▼/▲ buttons to choose ON.**
- 2 Press the OK button to complete the settings.**

The DEMO function is set to ON, and the demonstration will start.

*To stop the demonstration:*

Press one of the buttons on the remote control.

**When the DEMO function is set to ON:**

Each time the TV is turned on, the demonstration starts automatically. If you do not want that to happen, perform the following operations to cancel the DEMO function:

- 1 Display the DEMO menu again.**
- 2 Press the ▼/▲ buttons to choose OFF.**
- 3 Press the OK button to cancel the DEMO function.**

# ADDITIONAL MENU OPERATIONS

## ■ Using the ACI function

This TV has an ACI function which decodes the ACI (automatic Channel Installation) data.

Using the ACI function allows all TV channels transmitted from the cable TV station to be properly registered quickly according to the data from the cable TV station.

### Caution:

If your cable TV station broadcasts ACI data and if "ACI START/ACI SKIP" appears in the AUTO PROGRAM menu, the ACI function is enabled. In all other cases, it is disabled.

- 1 Press the **▼/▲** button to choose **ACI START**. Then press the **OK** button to start the ACI function.

#### When you don't want to use the ACI function:

Press the **▼/▲** button to choose ACI SKIP and then press the **OK** button.

#### If the AUTO PROGRAM menu changes to another menu:

Depending on your cable TV station, there may be a broadcast selection menu set up by the cable TV station. Follow the menu indications and use the **◀/▶** and **▼/▲** buttons to operate the menu. After you have made the setting, press the **OK** button.

#### If "ACI ERROR" is displayed in the AUTO PROGRAM menu:

"ACI ERROR" denotes that the ACI function is not working properly. Press the **OK** button to start the ACI function again.

If "ACI ERROR" still appears even after you have tried to start the ACI function several times, press the **▶** button to start the AUTO PROGRAM function. It does not cause any problem because all the TV channels are registered to the Programme numbers (PR) by the AUTO PROGRAM function.

- 2 When the settings are completed, the **EDIT** menu is displayed. Return to the instructions that you were reading before, and continue the operation.

#### When the "Initial Settings" has been made:

Return to step 6 of "Initial Settings" on page 4.

#### When the "AUTO PROGRAM" has been made:

Return to step 4 of "AUTO PROGRAM" on page 23.

#### Note:

- If you have any questions about the items in the Broadcast Selection menu or how to operate the menu, please contact your cable TV station.
- When the cable TV broadcast reception is poor, the ACI function will not work properly.
- If there is an error in the ACI data itself, the TV channel cannot be registered properly. If this happens, turn the ACI function off (ACI SKIP) and use the AUTO PROGRAM function. Alternatively, use the EDIT/MANUAL function to correct the Programme number (PR) setting.

## ■ Downloading the data to VCR

You can transmit to the latest Programme numbers (PR) data to the VCR with the T-V LINK function.

### Caution:

- Only when the T-V LINK compatible VCR is connected to the EXT-2 terminal, this operation is enabled.
- Only when the T-V LINK menu is being displayed, this operation is enabled.

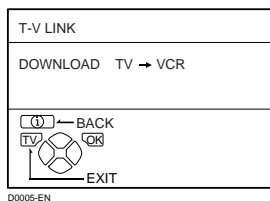

- 1 Turn on the VCR.

- 2 Press the **OK** button.

The data transmission begins.

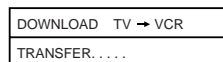

The T-V LINK menu disappears once the data transmission ends.

#### When the T-V LINK menu is changed over to another menu:

The menu operation at the TV side is completed and it is shifted to the menu operation at the VCR side. Refer to the VCR Instruction Manual and operate the VCR.

#### Note:

- If "FEATURE NOT AVAILABLE" appears at the T-V LINK menu, ensure the following three items are correct; then press the **OK** button to retry data transmission.
  - Has the T-V LINK compatible VCR been connected to the EXT-2 terminal?
  - Has the VCR power been turned on?
  - Does the SCART cable that is connected to the EXT-2 terminal to T-V LINK compatible VCR have all proper connections?

## ■ Changing the COUNTRY setting

After the AUTO PROGRAM function is completed, you can change the country you have already set by using the AUTO PROGRAM function.

When registering the TV channels for French broadcast stations (SECAM-L system), perform this operation to change the country.

- 1 Display the **INSTALL** menu.

#### When the EDIT menu is currently being displayed:

Press the **i** (Information) to return to the **INSTALL** menu.

**2 Press the ▼/▲ buttons to choose AUTO PROGRAM. Then press the OK button.**

A COUNTRY menu appears as a sub-menu of the AUTO PROGRAM function.  
There are two COUNTRY menus. Pressing the yellow button changes the COUNTRY as follows:

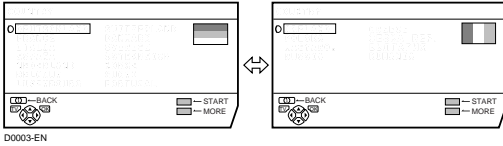

**3 Press the ◀/▶ and the ▼/▲ buttons to choose a country.**

**4 Press the OK button to complete the setting.**

The menu disappears.  
**To return to the INSTALL menu from the COUNTRY menu:**  
Press the ⓘ (Information) button instead of the OK button.

**■ Using the DECODER (EXT-2) function**

When connecting a Decoder with a T-V LINK compatible VCR connected to the EXT-2 terminal, use the DECODER (EXT-2) function to unscramble the scrambled TV channels.

- 1 Turn on the Decoder power.**
- 2 Display the TV channel capable of being unscrambled with the Decoder on the TV.**  
Even if the Decoder is functioning, a scrambled picture appears at this time.
- 3 Press the OK button to display the MENU.**  
The MENU (main menu) appears.
- 4 Press the ▼/▲ buttons to choose FEATURES. Then press the OK button.**

The FEATURES menu appears.

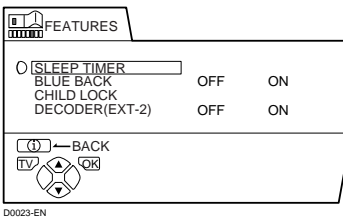

**5 Press the ▼/▲ buttons to choose DECODER (EXT-2) . Then press the ◀/▶ buttons to choose ON.**

An unscrambled picture appears.  
**To cancel the DECODER (EXT-2) function:**  
Press the ◀/▶ buttons to choose OFF.

**6 Press the OK button to complete the setting.**

The T-V LINK menu appears.

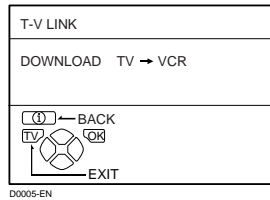

**7 Follow the operating procedure “Downloading the data to VCR” on page 28 to transmit the Programme number (PR) data to the VCR.**

**8 If you have another TV channel capable of being unscrambled with a Decoder, repeat steps 2 through 7.**

- Note:**
- If for some reason the DECODER (EXT-2) function has been set to “ON” but the TV channel cannot be unscrambled, check the following:
    - Has the Decoder been connected to the VCR properly according to the VCR and Decoder Instruction Manuals?
    - Has the Decoder power been turned on?
    - Can the TV channel be unscrambled with a Decoder?
    - Is it necessary to change the VCR settings in order to connect the Decoder? Confirm that the VCR is set properly by rechecking the VCR Instruction Manual.

## ■ Setting the SPEAKER function (Excluding AV28WH5EU)

Turn off the SPEAKER function so that TV speakers will not issue any sound.

1. Press the **OK** button to display the **MENU** (main menu).
2. Press the **▼/▲** buttons to choose **SOUND SETTING**. Then press the **OK** button to display the **SOUND SETTING** menu.

The SOUND SETTING menu appears.

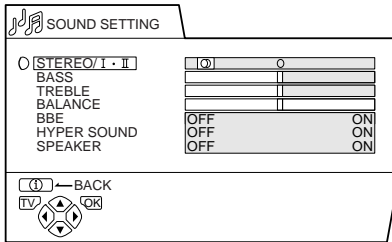

D0019-EN

3. Press the **▼/▲** buttons to choose **SPEAKER**. Then press the **◀/▶** buttons to choose **OFF**.
4. Press the **OK** button to complete the settings.

The sound from the TV speakers are cut.

The menu disappears.

### Note:

- The **◀/▶** buttons of the TV remote control and the **∇** (volume) buttons at the front panel of your TV set can be used to control the volume of each speaker simultaneously.
- Setting the volume of the amplifier too high may damage the front speakers.

# ADDITIONAL PREPARATION

## ■ Connecting the external devices

Connect the devices to the TV, paying attention to the following connection diagram.

### Before connecting anything:

- Read the manuals provided with the devices. Depending on the devices, the connection method may differ from the figure. In addition, the device settings may be changed depending on the connection method to secure proper operation.
- Turn off all the devices including the TV.
- The "SPECIFICATIONS" on page 37 contains the details of the EXT terminals. If you are connecting a device not listed in the following connection diagram, see the table to choose the best EXT terminal.
- Note that connecting cables are not supplied.

- ① VCR (composite signal)
- ② VCR (composite signal/S-VIDEO signal)
- ③ T-V LINK compatible VCR (composite signal/S-VIDEO signal)
- ④ Decoder
- ⑤ DVD player (composite signal/S-VIDEO signal)
- ⑥ DVD player (composite signal/RGB signal)
- ⑦ TV game (composite signal/RGB signal)
- ⑧ TV game (composite signal/S-VIDEO signal)
- ⑨ Headphones
- ⑩ Camcorder (composite signal/S-VIDEO signal)
- ⑪ SCART cable
- ⑫ Audio cable
- ⑬ Video cable
- ⑭ S-VIDEO cable

< AV32L2EU/AV28L2EU >

Side of the TV

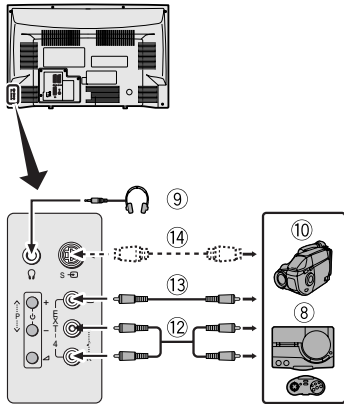

< AV32X10EU/AV28X10EU >

Behind the Cover

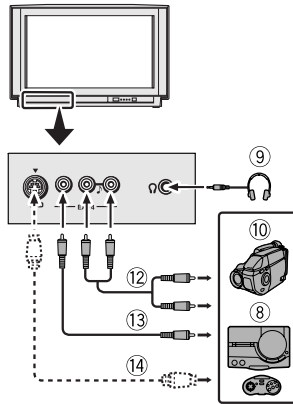

< AV28WH5EU >

Behind the Cover

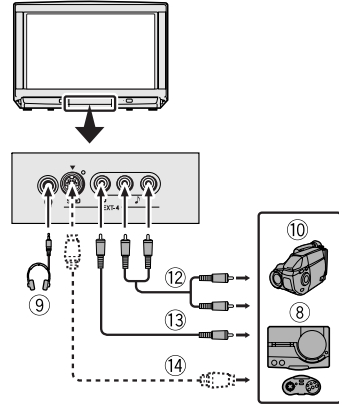

Back of the TV

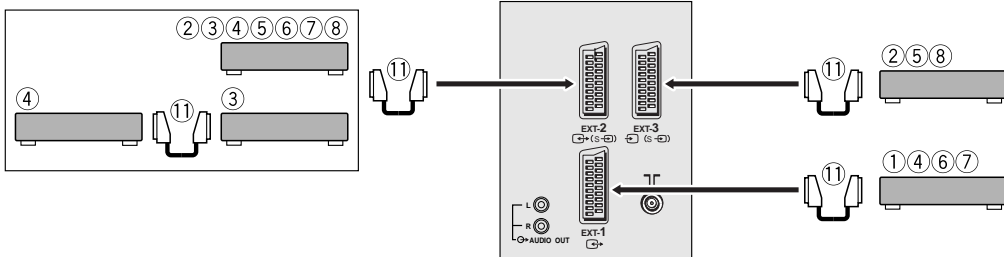



## Devices which can output the S-VIDEO signal (Y/C signal) such as a S-VHS VCR

Connect the device to an EXT terminal other than the EXT-1 terminal.

You can choose a video input signal from the S-VIDEO signal (Y/C signal) and regular video signal (composite signal). For details of how to operate the device, see "S-IN (S-VIDEO input)" on page 19.

## T-V LINK compatible VCR

Be sure to connect the T-V LINK compatible VCR to the EXT-2 terminal. If not, the T-V LINK function will not work properly.

### Note:

- When connecting a T-V LINK compatible VCR to the EXT-2 terminal, be sure to connect the Decoder to the VCR. If not, the T-V LINK function may not work properly. After you have registered TV channels to the Programme numbers (PR), set the DECODER (EXT-2) function for the Programme number (PR) to ON in order to unscramble a scrambled TV channel. For details of operation, see "Using the DECODER (EXT-2) function" on page 29.

## Connecting headphones

Connect the headphones with a stereo mini-jack (of 3.5mm in diameter) to the headphone jack at the TV front panel.

### Note:

- When you connect the headphones, the TV speakers issue no sound.

## Video/sound signal output from the EXT-2 terminal

You can arbitrarily change over the output of the video/sound signal from the EXT-2 terminal. It is useful when you want to dub the video/sound from another device on the VCR connected to the EXT-2 terminal. For details on how to do this operation, see "DUBBING" on page 20.

## TV output from the EXT-1 terminal

The output of video/sound signal of a TV channel you are currently viewing is always output from the EXT-1 terminal.

### Note:

- Changing over a Programme number (PR) also changes over the TV output from the EXT-1 terminal.
- The video/sound signal from an EXT terminal cannot be output.
- Teletext programmes cannot be output.

## ■ Connecting Speakers/Amplifier (Excluding AV28WH5EU)

While referring to the Audio equipment connection diagram, connect the audio equipment you desire to the TV.

You can use external front speakers to listen to the TV sound instead of the TV speakers. For details of how to operate them, see "Setting the SPEAKER function (Excluding AV28WH5EU)" on page 30.

### Before connecting anything:

- Read the manuals provided with the amplifier and speakers.
- Turn the TV and Amplifier off.
- To prevent magnetism from the speakers adversely affecting the TV screen, use magnetic-shielded speakers for the front speakers.
- Note that connecting cables are not supplied.

### Back of the TV

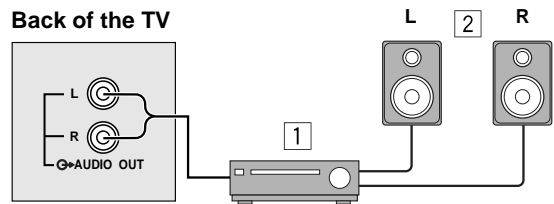

1 Amplifier

2 Front speakers (Magnetic-shielded type)

### Note:

- The output from the AUDIO OUT terminal is not interrupted by headphone connection to the TV. You cannot cut the sound from the front speaker even if you connect a headphone to the TV.

# CH/CC NUMBER

When you want to use the INSERT function on page 25, find the CH/CC number corresponding to the Channel number of the TV channel from this table.

CH	Channel
CH 02 / CH 202	E2, R1
CH 03 / CH 203	E3, ITALY A
CH 04 / CH 204	E4, ITALY B, R2
CH 05 / CH 205	E5, ITALY D, R6
CH 06 / CH 206	E6, ITALY E, R7
CH 07 / CH 207	E7, ITALY F, R8
CH 08 / CH 208	E8, R9
CH 09 / CH 209	E9, ITALY G
CH 10 / CH 210	E10, ITALY H, R10
CH 11 / CH 211	E11, ITALY H+1, R11
CH 12 / CH 212	E12, ITALY H+2, R12
CH 21 / CH 221	E21, R21
CH 22 / CH 222	E22, R22
CH 23 / CH 223	E23, R23
CH 24 / CH 224	E24, R24
CH 25 / CH 225	E25, R25
CH 26 / CH 226	E26, R26
CH 27 / CH 227	E27, R27
CH 28 / CH 228	E28, R28
CH 29 / CH 229	E29, R29
CH 30 / CH 230	E30, R30
CH 31 / CH 231	E31, R31
CH 32 / CH 232	E32, R32
CH 33 / CH 233	E33, R33
CH 34 / CH 234	E34, R34
CH 35 / CH 235	E35, R35
CH 36 / CH 236	E36, R36
CH 37 / CH 237	E37, R37
CH 38 / CH 238	E38, R38
CH 39 / CH 239	E39, R39

CH	Channel
CH 40 / CH 240	E40, R40
CH 41 / CH 241	E41, R41
CH 42 / CH 242	E42, R42
CH 43 / CH 243	E43, R43
CH 44 / CH 244	E44, R44
CH 45 / CH 245	E45, R45
CH 46 / CH 246	E46, R46
CH 47 / CH 247	E47, R47
CH 48 / CH 248	E48, R48
CH 49 / CH 249	E49, R49
CH 50 / CH 250	E50, R50
CH 51 / CH 251	E51, R51
CH 52 / CH 252	E52, R52
CH 53 / CH 253	E53, R53
CH 54 / CH 254	E54, R54
CH 55 / CH 255	E55, R55
CH 56 / CH 256	E56, R56
CH 57 / CH 257	E57, R57
CH 58 / CH 258	E58, R58
CH 59 / CH 259	E59, R59
CH 60 / CH 260	E60, R60
CH 61 / CH 261	E61, R61
CH 62 / CH 262	E62, R62
CH 63 / CH 263	E63, R63
CH 64 / CH 264	E64, R64
CH 65 / CH 265	E65, R65
CH 66 / CH 266	E66, R66
CH 67 / CH 267	E67, R67
CH 68 / CH 268	E68, R68
CH 69 / CH 269	E69, R69

CC	Channel
CC 01 / CC 201	S1
CC 02 / CC 202	S2
CC 03 / CC 203	S3
CC 04 / CC 204	S4
CC 05 / CC 205	S5
CC 06 / CC 206	S6
CC 07 / CC 207	S7
CC 08 / CC 208	S8
CC 09 / CC 209	S9
CC 10 / CC 210	S10
CC 11 / CC 211	S11
CC 12 / CC 212	S12
CC 13 / CC 213	S13
CC 14 / CC 214	S14
CC 15 / CC 215	S15
CC 16 / CC 216	S16
CC 17 / CC 217	S17
CC 18 / CC 218	S18
CC 19 / CC 219	S19
CC 20 / CC 220	S20
CC 21 / CC 221	S21
CC 22 / CC 222	S22
CC 23 / CC 223	S23
CC 24 / CC 224	S24
CC 25 / CC 225	S25
CC 26 / CC 226	S26
CC 27 / CC 227	S27
CC 28 / CC 228	S28
CC 29 / CC 229	S29
CC 30 / CC 230	S30

CC	Channel
CC 31 / CC 231	S31
CC 32 / CC 232	S32
CC 33 / CC 233	S33
CC 34 / CC 234	S34
CC 35 / CC 235	S35
CC 36 / CC 236	S36
CC 37 / CC 237	S37
CC 38 / CC 238	S38
CC 39 / CC 239	S39
CC 40 / CC 240	S40
CC 41 / CC 241	S41
CC 75 / CC 275	X
CC 76 / CC 276	Y, R3
CC 77 / CC 277	Z, ITALY C, R4
CC 78 / CC 278	Z+1, R5
CC 79 / CC 279	Z+2

CH	Channel
CH 102	F2
CH 103	F3
CH 104	F4
CH 105	F5
CH 106	F6
CH 107	F7
CH 108	F8
CH 109	F9
CH 110	F10
CH 121	F21
CH 122	F22
CH 123	F23
CH 124	F24
CH 125	F25
CH 126	F26
CH 127	F27
CH 128	F28
CH 129	F29
CH 130	F30
CH 131	F31
CH 132	F32
CH 133	F33
CH 134	F34
CH 135	F35
CH 136	F36
CH 137	F37
CH 138	F38
CH 139	F39
CH 140	F40

CH	Channel
CH 141	F41
CH 142	F42
CH 143	F43
CH 144	F44
CH 145	F45
CH 146	F46
CH 147	F47
CH 148	F48
CH 149	F49
CH 150	F50
CH 151	F51
CH 152	F52
CH 153	F53
CH 154	F54
CH 155	F55
CH 156	F56
CH 157	F57
CH 158	F58
CH 159	F59
CH 160	F60
CH 161	F61
CH 162	F62
CH 163	F63
CH 164	F64
CH 165	F65
CH 166	F66
CH 167	F67
CH 168	F68
CH 169	F69

CC	Frequency (MHz)
CC 110	116 - 124
CC 111	124 - 132
CC 112	132 - 140
CC 113	140 - 148
CC 114	148 - 156
CC 115	156 - 164
CC 116	164 - 172
CC 123	220 - 228
CC 124	228 - 236
CC 125	236 - 244
CC 126	244 - 252
CC 127	252 - 260
CC 128	260 - 268
CC 129	268 - 276
CC 130	276 - 284
CC 131	284 - 292
CC 132	292 - 300
CC 133	300 - 306
CC 141	306 - 311
CC 142	311 - 319
CC 143	319 - 327
CC 144	327 - 335
CC 145	335 - 343
CC 146	343 - 351
CC 147	351 - 359
CC 148	359 - 367
CC 149	367 - 375
CC 150	375 - 383
CC 151	383 - 391

CC	Frequency (MHz)
CC 152	391 - 399
CC 153	399 - 407
CC 154	407 - 415
CC 155	415 - 423
CC 156	423 - 431
CC 157	431 - 439
CC 158	439 - 447
CC 159	447 - 455
CC 160	455 - 463
CC 161	463 - 469

## Note:

- When two CH/CC numbers correspond to one Channel number, choose either one according to the current COUNTRY setting. When the COUNTRY setting is other than FRANCE, choose a two-digit CH/CC number. When the COUNTRY setting is FRANCE, choose a three-digit CH/CC number.
- Find the CH/CC number (CC110 to CC161) corresponding to the TV channel (SECAM-L system) from a French cable TV station, based on the broadcast frequency of the TV channel. When you do not know the broadcast frequency, please contact the cable TV station.
- The CH/CC numbers of CH102-CH169 and CC110-CC161 correspond to the TV channels being broadcast by a SECAM-L system. The other CH/CC numbers correspond to the TV channels being broadcast by a method other than a SECAM-L system.

# TV BUTTONS AND PARTS

## ■ Front Panel

< AV32L2EU/AV28L2EU >

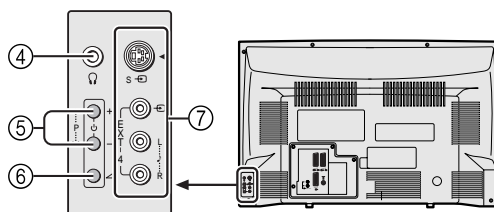
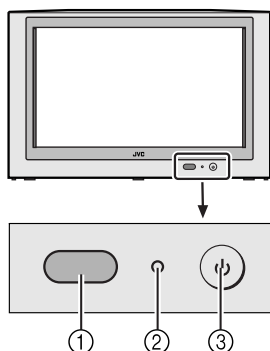

< AV32X10EU/AV28X10EU >

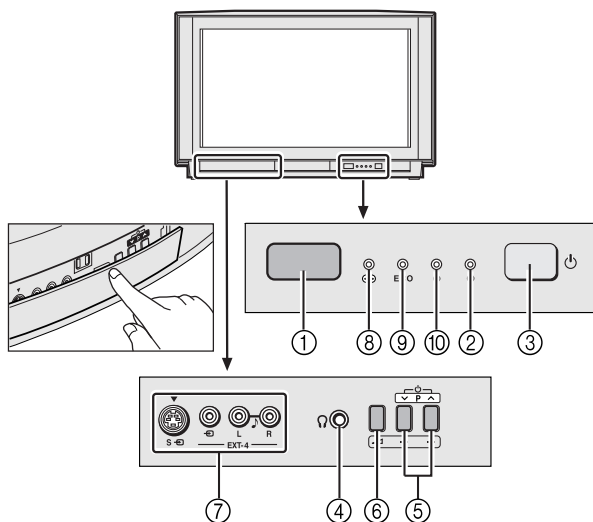

< AV28WH5EU >

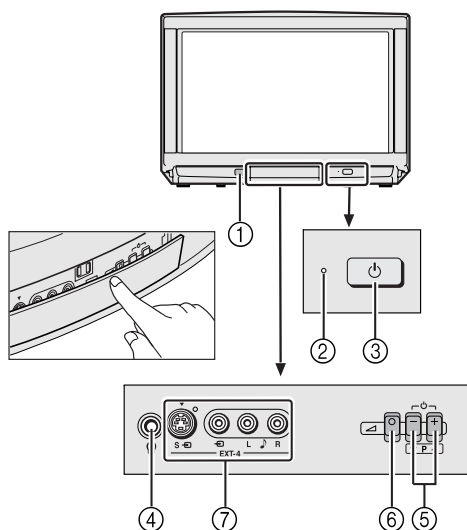

- ① Remote control sensor and ECO sensor

---

- ② Power lamp pages 3 and 6

---

- ③ Main power button pages 3 and 6

---

- ④ Headphone jack (mini jack) page 31

---

- ⑤ P  $\nabla/\blacktriangle$  buttons /  $-/+$  buttons page 8

- ⑥ (Volume) button page 8

---

- ⑦ EXT-4 terminal pages 19 and 31

---

- ⑧ HYPERSOUND lamp (Only AV32X10EU and AV28X10EU)
  - The HYPERSOUND lamp lights while the HYPERSOUND function is in use.

---

- ⑨ ECO lamp (Only AV32X10EU and AV28X10EU)
  - If you set the ECO MODE function to ON, the ECO lamp lights.

---

- ⑩ SLEEP TIMER lamp (Only AV32X10EU and AV28X10EU)
  - The SLEEP TIMER lamp lights while the SLEEP TIMER function is operating.

## ■ Rear Panel

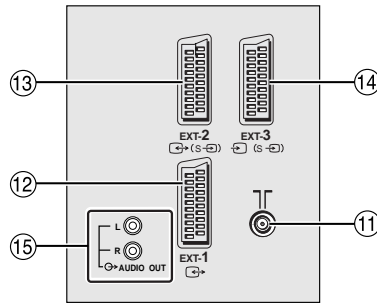

① Aerial socket	page 2
⑫ EXT-1 terminal	pages 2, 19 and 31
⑬ EXT-2 terminal	pages 2, 5, 19 and 31

⑭ EXT-3 terminal	pages 19 and 31
⑮ AUDIO OUT terminal (Excluding AV28WH5EU)	page 32

# TROUBLESHOOTING

If a problem arises while you are using the TV, please read this "Troubleshooting" well before you request having the TV repaired. You may be able to fix it easily by yourself. For example, if the AC plug is disconnected from the AC outlet, or the TV aerial has problems, you may think there is a problem with the TV itself.

### Important:

- This Troubleshooting guide only covers problems whose cause are not easy to determine. If a question arise when you are operating a function, read the page(s) corresponding to the operation of the function well, not this Troubleshooting guide.
- After you have followed the Troubleshooting description or the operating description of the functions concerned without any success, remove the AC plug from the AC outlet and request a repair of your TV. Do not attempt to repair the TV by yourself or remove the rear cover of the TV.

## If you cannot turn on the TV

- Is the AC plug connected to the AC outlet?
- Is the Power lamp lit? If not, press the Main power button.

## No picture/No sound

- Have you chosen a TV channel whose reception is extremely bad? In this case, the BLUE BACK function will be activated, the entire screen becomes blue, and the sound is muted. In spite of this, if you want to view the TV channel, follow the description "BLUE BACK" on page 21 to try to change the BLUE BACK function setting to OFF.
- Have you connected the headphones to the TV? Connecting the headphones to the TV causes sounds not to be issued from the TV speakers.
- Have you set the SPEAKER function to OFF? Follow the description "SPEAKER (Excluding AV28WH5EU)" on page 18 to confirm the SPEAKER function setting to try to solve the problem.
- If the SYSTEM setting for a TV channel is incorrect, it may prevent the sound from being issued. Follow the description "EDIT/MANUAL" on page 24 to use the MANUAL function to try to change the SYSTEM setting.

## Poor picture

- If noise totally obscures the picture (snow), the aerial or aerial cable may have trouble. Check the following to try to solve the trouble:

Has the TV and aerial been connected properly?

Has the aerial cable been damaged?

Is the aerial pointed to the right direction?

Is the aerial itself faulty?

- If the TV or aerial receives interference from the other devices, stripes or noise may appear in the picture. Move such devices as an amplifier, personal computer, or a hair dryer that can cause interference away from your TV, or try changing its location. If the aerial suffers interference from a radio tower or high-voltage wire, please contact your local dealer.
- If the TV receives interference from signal reflecting from mountains or building, double-pictures (ghosting) will occur. Try to change the aerial's direction or replace the antenna with the one with better directionality.
- Are your COLOUR SYSTEM settings for the TV channels correct? Follow the description "COLOUR SYSTEM" on page 17 to try to solve the trouble.
- Has COLOUR or BRIGHT been controlled properly? Follow the description "Picture Adjustment" on page 15 to try to adjust them properly.

- Videotaping teletext is not recommended because it may not record correctly.
- When a white and bright still image (such as a white dress) is displayed on the screen, the white part may look as if it were coloured. It is a phenomenon unavoidable due to the nature of the picture tube itself, and not due to a TV failure. When the picture disappears from the screen, the unnatural colours will also disappear.
- When viewing images from commercially available video software products, or videos from videotapes which have been recorded improperly, the top of the image may be distorted. This is due to the condition of the video signal, and not because of malfunction.
- The TV may emit a crackling sound due to a sudden change in temperature. It does not matter if a picture or sound does not show any abnormality. If you hear crackling sounds frequently while you are viewing the TV, other causes may be assumed. For precautionary purposes, request your service technician to inspect it.
- Touching the screen may cause you feel a slight electric shock due to its static electricity. It is an unavoidable phenomenon due to the construction of the picture tube. It is not a problem with the TV. You can rest assured that this static discharge does not have harmful influence over the human body.
- When a menu is displayed on the screen, the ZOOM mode may be automatically changed to the FULL mode. This is not a malfunction. When the menu disappears, the ZOOM mode will return to the previously set ZOOM mode.

### Poor sound

- Have you adjusted BASS or TREBLE properly? If not, follow the description "Sound Adjustment" on page 18 to try to adjust them properly.
- When the TV channel reception is poor, it can be hard to hear the stereo or bilingual sound. In this case, follow the description "STEREO / L•I" on page 18 to hear the sound more easily by changing it to a mono sound.

### Operation disabled

- Have the batteries of the remote control become exhausted? Follow the description "Putting Batteries into the Remote Control" on page 2 and replace them with new batteries to try to solve the problem.
- Have you attempted to use the remote control at the sides or rear of the TV or at a location more than seven meters apart from the TV location? Operate the remote control in the front of your TV or a location less than seven meters from your TV to try to solve the problem.
- When you are viewing a teletext programme, you cannot operate the menus. Press the **TV** button to return the teletext programme to the ordinary TV programme to try operating the menus.
- If the TV operation becomes disabled suddenly, press the Main power button on the TV and turn off the main power. Try to press the Main power button again to turn on the main power. If the TV returns to a normal state, it is not a failure.

### Other concerns

- When the SLEEP TIMER function operates, the TV is automatically turned off. If the TV is turned off suddenly, try to press the  (Standby) button to turn on the TV once again. At this time, if the TV resumes a normal state, there is no problem.
- When a WSS signal is included in the broadcast signal or the signal from an external device, or when the TV is receiving a control signal from an external device, the ZOOM mode will change automatically. When you want to return to the previous ZOOM mode, press the **ZOOM** button to choose the ZOOM mode again.
- If you bring a magnetised device such as a speaker near to your TV, a picture may be warped or unnatural colors appear at the corners of the screen. In this case, keep the device apart from your TV. If the speakers causes such phenomena, use the magnetic-shielded speakers instead.
- A picture may be tilted due to the influence of the earth's magnetism. In this case, use the "PICTURE TILT (Excluding AV28WH5EU)" on page 17 to complete the tilt.
- It takes a short period of time from the time an operation such as changing channels is performed until an image is displayed. This is not a malfunction. This is the time required for the image to stabilize before it can be displayed.

# SPECIFICATIONS

Item	Model	AV32L2EU*	AV28L2EU*
Broadcasting systems		CCIR B/G, I, D/K, L	
Colour systems		PAL, SECAM • The EXT terminals also support the NTSC 3.58/4.43 MHz system.	
Channels and frequencies		<ul style="list-style-type: none"> <li>E2-E12, E21-E69, S1-S41, X, Y, Z, Z+1, Z+2, ITALY A-H, ITALY H+1, ITALY H+2, F2-F10, F21-F69, R1-R12, R21-R69</li> <li>French cable TV channel of broadcast frequencies 116 - 172 MHz and 220 - 469 MHz</li> </ul>	
Sound-multiplex systems		A2 (B/G, D/K), NICAM (B/G, I, D/K, L) system	
Teletext systems		FLOF (Fastext), TOP, WST (World Standard System)	
Power requirements		220 - 240 V AC, 50 Hz	
Power consumption		Maximum: 189 W, Average: 140 W, Standby: 2.8 W	Maximum: 183 W, Average: 127 W, Standby: 2.8 W
Picture tube size		Viewable area 76 cm (measured diagonally)	Viewable area 66 cm (measured diagonally)
Audio output		Rated Power output: 7.5 W + 7.5 W	
Speakers		(20 cm × 4 cm) oval × 2	
EXT-1 terminal		Euroconnector (21-pin, SCART) • Video input, Audio L/R inputs and RGB inputs are available. • TV broadcast outputs (Video and Audio L/R) are available.	
EXT-2 terminal		Euroconnector (21-pin, SCART) • Video input, S-VIDEO (Y/C) input, Audio L/R inputs and RGB inputs are available. • Video and Audio L/R outputs are available. • T-V LINK functions are available.	
EXT-3 terminal		Euroconnector (21-pin, SCART) • Video input, S-VIDEO (Y/C) input and Audio L/R inputs are available.	
EXT-4 terminal		RCA connectors × 3 S-VIDEO connector × 1 • Video input, S-VIDEO (Y/C) input and Audio L/R inputs are available.	
AUDIO OUT terminal		RCA connectors × 2 • Variable audio L/R outputs are available. • Variable out 0-1 Vrms, low impedance	
Headphone jack		Stereo mini-jack (3.5 mm in diameter)	
Dimensions (W × H × D)		901 mm × 556 mm × 557 mm	800 mm × 500 mm × 498 mm
Weight		53.8 kg	41 kg
Accessories		Remote control unit × 1 (RM-C54) AAA/R03 dry cell battery × 2	

\* A basic model number. The actual model number may have characters added (such as "S" denoting silver) indicating the colour of the TV set.

**Design and specifications subject to change without notice.**

Pictures displayed on the screen using this TV's ZOOM functions should not be shown for any commercial or demonstration purpose in public places (cafes, hotels, etc.) without the consent of the owners of copyright of the original picture sources, as this constitutes an infringement of copyright.

## SPECIFICATIONS

Item	Model	AV32X10EU*	AV28X10EU*	AV28WH5EU*
Broadcasting systems		CCIR B/G, I, D/K, L		
Colour systems		PAL, SECAM • The EXT terminals also support the NTSC 3.58/4.43 MHz system.		
Channels and frequencies		<ul style="list-style-type: none"> <li>E2-E12, E21-E69, S1-S41, X, Y, Z, Z+1, Z+2, ITALY A-H, ITALY H+1, ITALY H+2, F2-F10, F21-F69, R1-R12, R21-R69</li> <li>French cable TV channel of broadcast frequencies 116 - 172 MHz and 220 - 469 MHz</li> </ul>		
Sound-multiplex systems		A2 (B/G, D/K), NICAM (B/G, I, D/K, L) system		
Teletext systems		FLOF (Fastext), TOP, WST (World Standard System)		
Power requirements		220 - 240 V AC, 50 Hz		
Power consumption		Maximum: 189 W, Average: 140 W, Standby: 2.8 W	Maximum: 183 W, Average: 127 W, Standby: 2.8 W	Maximum: 165 W, Average: 112 W, Standby: 2.8 W
Picture tube size		Viewable area 76 cm (measured diagonally)	Viewable area 66 cm (measured diagonally)	
Audio output		Rated Power output: 7.5 W + 7.5 W		Rated Power output: 5 W + 5 W
Speakers		(16 cm × 4 cm) oval × 2		10 cm round × 2
EXT-1 terminal		Euroconnector (21-pin, SCART) • Video input, Audio L/R inputs and RGB inputs are available. • TV broadcast outputs (Video and Audio L/R) are available.		
EXT-2 terminal		Euroconnector (21-pin, SCART) • Video input, S-VIDEO (Y/C) input, Audio L/R inputs and RGB inputs are available. • Video and Audio L/R outputs are available. • T-V LINK functions are available.		
EXT-3 terminal		Euroconnector (21-pin, SCART) • Video input, S-VIDEO (Y/C) input and Audio L/R inputs are available.		
EXT-4 terminal		RCA connectors × 3 S-VIDEO connector × 1 • Video input, S-VIDEO (Y/C) input and Audio L/R inputs are available.		
AUDIO OUT terminal		RCA connectors × 2 • Variable audio L/R outputs are available. • Variable out 0-1 Vrms, low impedance	—	
Headphone jack		Stereo mini-jack (3.5 mm in diameter)		
Dimensions (W × H × D)		855 mm × 550 mm × 568 mm	780 mm × 509 mm × 499 mm	716 mm × 489 mm × 496 mm
Weight		54.2 kg	40.2 kg	34.3 kg
Accessories		Remote control unit × 1 (RM-C54 (Silver) or RM-C50 (Black) is supplied.) AAA/R03 dry cell battery × 2		

\* A basic model number. The actual model number may have characters added (such as "S" denoting silver) indicating the colour of the TV set.

### Design and specifications subject to change without notice.

Pictures displayed on the screen using this TV's ZOOM functions should not be shown for any commercial or demonstration purpose in public places (cafes, hotels, etc.) without the consent of the owners of copyright of the original picture sources, as this constitutes an infringement of copyright.