



COLOR TELEVISION

INSTRUCTIONS

Thank you for buying this JVC color television.
To make sure you understand how to use your new TV, please read this manual thoroughly before you begin.

- AV-21W33**
- AV-25L33**
- AV-29W33**
- AV-21W33B**
- AV-25L33B**
- AV-29W33B**



Contents

Safety precautions	2
Preparation	3
1 Confirm which remote control you have ...	3
2 Insert the batteries into the remote control ...	3
3 Connecting the antenna and VCR	4
4 Connecting other devices	5
5 Connect the power cord to the AC outlet ...	5
6 Initial setting	6
Basic operation	7
Remote control buttons and functions	8
ECO SENSOR button	8
PICTURE MODE button	8
CLOSED CAPTION button	8
BASS button	8
OFF TIMER button	8
COLOR SYSTEM button	8
CHANNEL SCAN button	9
CINEMA SURROUND button	9
RETURN + button	9
DISPLAY button	9
MUTING button	9
Using the TV's menus	10
Basic operation	10
INPUT	11
PICTURE TILT	11
VNR	11
COMPRESS (16:9)	11
CLOSED CAPTION	12
CHILD LOCK	12
BLUE BACK	12
AUTO SHUTOFF	12
VIDEO-2 SET	13
AUTO CH PRESET	13
CHANNEL SKIP	14
LANGUAGE	14
MTS	14
Picture adjustment	15
Sound adjustment	15
AI VOLUME	15
Attaching the Twin Port Bass Blaster Unit	16
TV buttons and parts	17
Using the buttons on the TV	18
Troubleshooting	19
Specifications	Back cover



Safety precautions

WARNING

- To prevent fire or shock hazard, do not expose the TV to rain or moisture.

CAUTION

- Operate only from the power source indicated on the rear of the TV.
- Avoid damaging the power cord and mains plug. When you unplug the TV, pull it out by the mains plug. Do not pull on the power cord.
- Never block or cover the cabinet openings for ventilation. Never install the TV where good ventilation is unattainable. When installing this TV, leave spaces for ventilation around the TV more than the minimum distances shown in the diagram.
- Do not allow objects or liquid into the cabinet openings.
- In the event of a fault, unplug the TV and call a service technician. Do not attempt to repair it by yourself or remove the rear cover.
- The surface of the TV screen is easily damaged. Be very careful with it when handling the TV. Should the TV screen become soiled, wipe it with a soft dry cloth. Never rub it forcefully. Never use any cleaner or detergent on it.
- When you don't use this TV for a long period of time, be sure to unplug it.

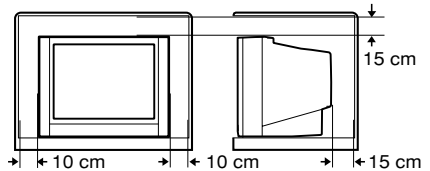

< AV-21W33B/AV-25L33B/AV-29W33B only >

The Twin Port Bass Blaster Unit is packaged together with the TV.
Before you use the TV, mount the Twin Port Bass Blaster Unit correctly on the TV.

Preparation

1 Confirm which remote control you have

Your TV comes with one of the two remote controls shown below. Functions you can operate differ depending on the type of remote control.

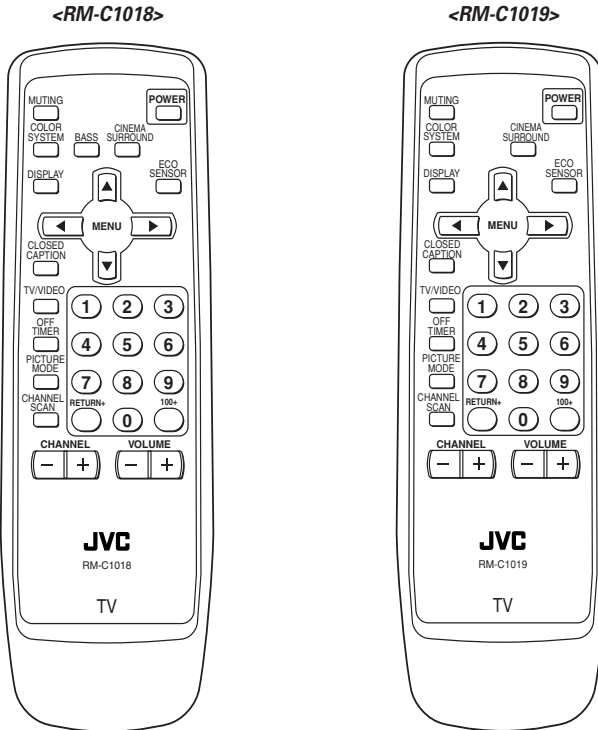

2 Insert the batteries into the remote control

Correctly insert two batteries, observing the ⊕ and ⊖ polarities and inserting the ⊖ end first.

CAUTION:

Follow the cautions printed on the batteries.

Notes:

- Use AA/R6/UM-3 dry cell batteries.
- If the remote control does not work properly, replace with new batteries.
The supplied batteries are for testing, not regular use.

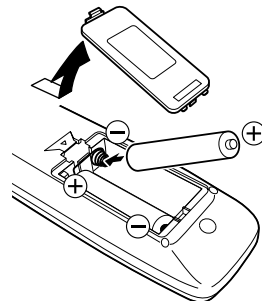

Preparation

3 Connecting the antenna and VCR

- Read the manuals provided with the devices. Depending on the device, the connection method may be different from the diagrams. Also the device settings may need to change depending on the connection method.
- Turn off all the devices including the TV.
- Connecting cables are not supplied.
- When connecting monaural audio to the TV, use the L/MONO jack.

Connecting the antenna

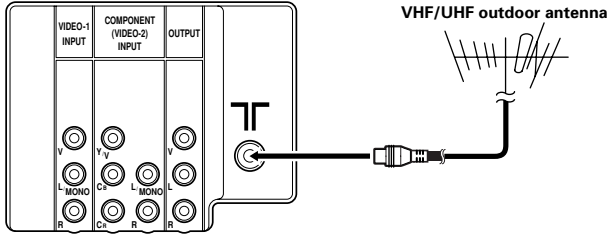

Connecting the antenna and VCR

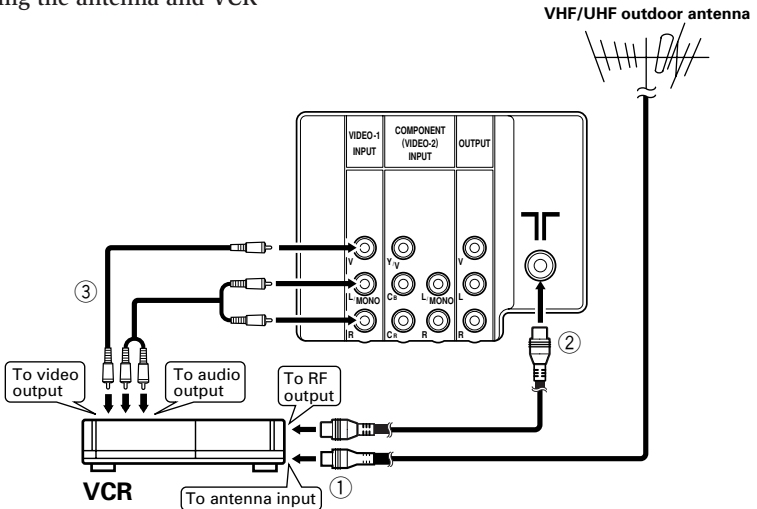

Preparation

4 Connecting other devices

If you are not connecting any other devices, skip step 4 and perform step 5.

- Use the headphones with a stereo mini jack (3.5 mm in diameter). When you connect the headphones, the TV speakers go off.
- The OUTPUT terminal outputs the video and sound signals which you are viewing on the TV. You can dub them onto the VCR connected to the OUTPUT terminal.
(The OUTPUT terminal cannot output component video signals. Also it cannot output any signals when the TV is turned off.)
- Connect components outputting a component signal (Y/C_B/C_R signal), such as a DVD player, to the VIDEO-2 terminal, and set VIDEO-2 SET function to “COMPONENT”. (See page 13.)
- The following illustrations are for the AV-29W33. Your TV’s front and rear panels may not look exactly like the illustrations.

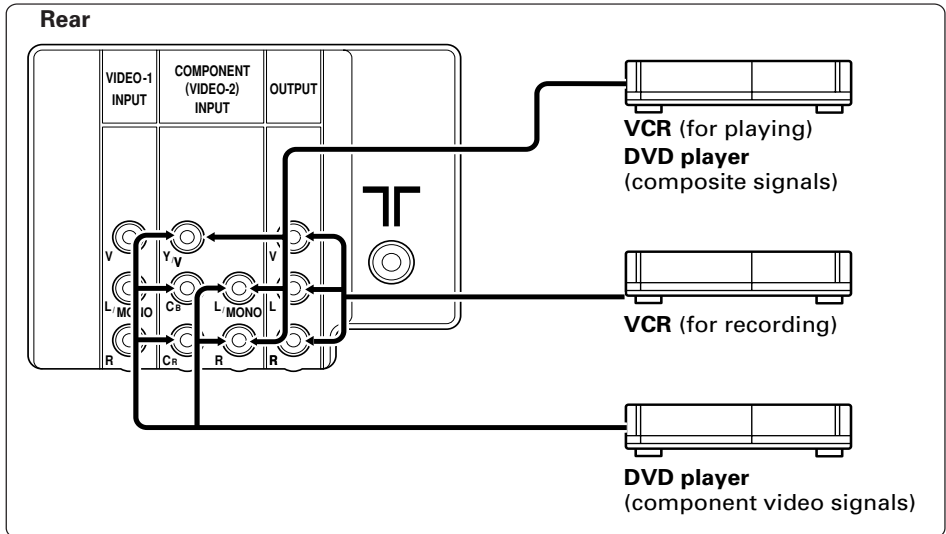
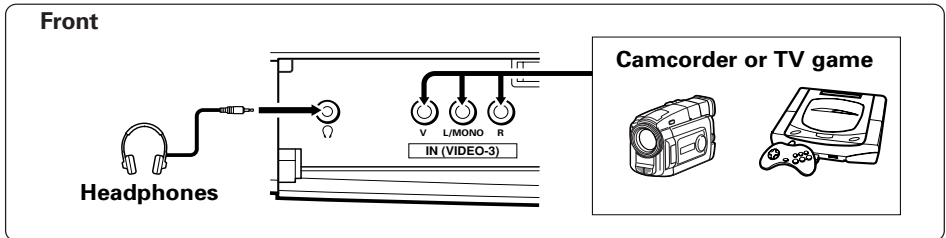

5 Connect the power cord to the AC outlet

Operate only from the power source indicated on the rear of the TV.

Preparation

6 Initial setting

When the TV is first turned on, it enters the initial setting mode, and the JVC logo is displayed. Follow the instructions on the on-screen display to perform the initial settings.

1 Press the Main power button on the TV.

The POWER lamp lights. After the JVC logo has been displayed, the TV automatically switches to the language setting mode.

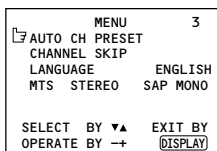

- The JVC logo does not appear if your TV has been turned on once before. In this case, use the LANGUAGE and AUTO CH PRESET functions to perform the initial settings. For details, see page 13 and 14.

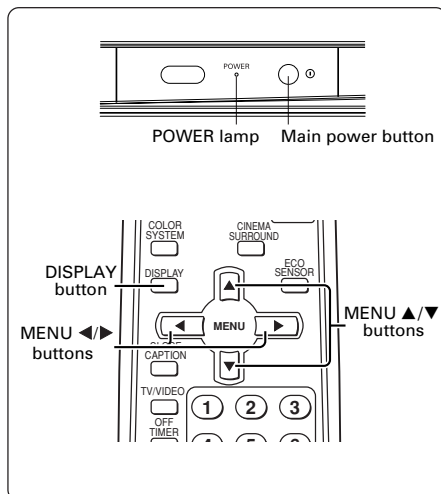

2 Press the MENU ◀/▶ buttons to select language.

3 Press the MENU ▲/▼ buttons to select "AUTO CH PRESET".

4 Press the MENU ◀/▶ buttons.

The sub-menu is displayed.

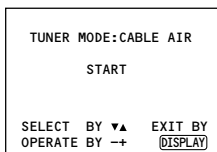

5 Press the MENU ◀/▶ buttons to select "CABLE" or "AIR".

6 Press the MENU ▲/▼ buttons to select "START".

7 Press the MENU ◀/▶ buttons to start the AUTO CH PRESET function.

">>> ON SEARCH" is displayed on the screen.

When all the TV channels that can be received on your TV have been preset, the display goes out and the AUTO CH PRESET function operation is completed.

To stop the AUTO CH PRESET function, press the MENU ◀/▶ buttons.

Basic operation

- The illustration below is for the remote control RM-C1019 supplied with L33 and W33 series models. Your remote control may not look exactly like the illustrations.

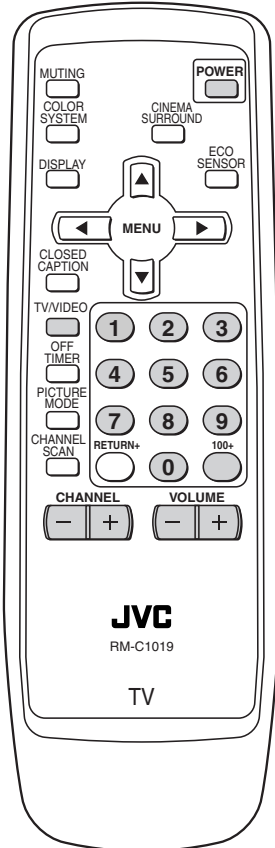

1 Press the POWER button to turn your TV on.

- If your TV does not turn on, press the Main power button on the TV then press the POWER button again.
- You can also turn on your TV by pressing any of the following buttons;
 - the CHANNEL +/- button
 - the TV/VIDEO button

2 Select a channel.

- Press the CHANNEL +/- button.
 - Up/down selection cannot be selected for channels to which the CHANNEL SKIP function has been set to "YES". See page 14.
- Press the Number buttons to enter the channel number.
 - When you want to select a channel number over 100, enter the two-digit number after pressing the 100+ button.

3 Press the VOLUME +/- button to adjust the sound.

4 To turn your TV off, press the POWER button.

- We recommend that you press the Main power button on the TV to turn the main power off if you do not plan to use your TV for a long time or if you wish to save energy.

Viewing Images from an External Device:

Press the TV/VIDEO button to select the VIDEO mode.

- You can also use the INPUT function to select the VIDEO mode. For details, refer to page 11.

If the picture is not clear:

Press the COLOR SYSTEM button to select another color system, see page 8.

- Color system cannot be changed in TV mode.

Remote control buttons and functions

ECO SENSOR button

You can adjust this TV so that the screen automatically adjusts to the optimum contrast according to the brightness of your room. This function reduces eye strain and the power consumption of this TV.

Press this button to select the desired mode.

DIGITAL ECO SENSOR DISPLAY:

The ECO SENSOR function switches on. In this mode, the clover mark indicating the brightness of your room is displayed for several seconds each time the brightness changes. The number of clover marks displayed on screen increases as your room becomes darker.

DIGITAL ECO SENSOR:

The ECO SENSOR function switches on. However, in this mode, the clover mark will not be displayed.

DIGITAL ECO SENSOR OFF:

The ECO SENSOR function switches off.

PICTURE MODE button

You can select one of three picture adjustment settings as you like.

Press this button to select a mode.

BRIGHT:

Heightens contrast and sharpness.

STANDARD:

Standardizes picture adjustments.

SOFT:

Softens contrast and sharpness.

- Pressing this button returns all the picture settings in "MENU 4" to their default settings.

CLOSED CAPTION button

If they are included in a program, you can view closed captions or text information.

Press this button to select the mode.

→ OFF → CLOSED CAPTION → TEXT

- To change caption or text channels see page 12.

BASS button

< AV-21W33B/AV-25L33B/AV-29W33B only >

You can enjoy a powerful bass sound by using the SUPER BASS (Bass Reflex) function.

Press this button to turn the SUPER BASS function on or off.

- To use this function, you must first mount the Twin Port Bass Blaster Unit packaged with the TV on top of the TV. For details, see page 16.

OFF TIMER button

You can set the TV to automatically turn off after a set time.

Press this button to select the period of time.

- You can set the period of time to a maximum of 120 minutes in 10 minute increments.
- 1 minute before the OFF TIMER function turns off the TV, "GOOD NIGHT!" appears.

To display the remaining time, press this button once.

To cancel the OFF TIMER function, press this button to set the period of time to 0.

- The OFF TIMER function will not turn off the TV's main power.

COLOR SYSTEM button

If the picture is not clear or no color appears, change the current color system to another color system.

Press this button to select the color system.

In TV mode:

NTSC3.58 (fixed)

In VIDEO mode:

→ AUTO → NTSC3.58
PAL ← NTSC4.43 ←

AUTO:

Automatic color system selection

- If the picture is abnormal in the AUTO mode, change the AUTO mode to another color system.
- Only in VIDEO mode, "COLOR SYSTEM" is displayed in MENU 2 and can be changed.

Remote control buttons and functions

CHANNEL SCAN button

You can quickly view all TV channels programs that you can view on your TV, and search for the program you want to view.

1 Press this button to start scanning TV channels.

The TV channel programs are each displayed for several seconds.

- The programs of TV channels for which the CHANNEL SKIP function is set to “YES” are not displayed.

2 When you find the program you want to view, press this button again to stop scanning.

CINEMA SURROUND button

You can enjoy an enhanced sound for a wider audience by using CINEMA SURROUND function.

Press this button to select one of the CINEMA SURROUND mode.

HIGH/LOW:

When you listen to the stereo sound, please select HIGH mode or LOW mode. You can enjoy the sound for a wider audience similar to the experience at the theatre.

- In case that you setting up the CINEMA SURROUND function to HIGH mode, there may be slight volume distortion. In case that occurs, please switch the HIGH mode to LOW mode, the effect of CINEMA SURROUND functions will be less noticeable, however, the volume distortion will be corrected.

MONO SURROUND:

Select the MONO SURROUND mode, when you listen to the mono sound. You can enjoy the sound for a wider audience similar to stereo sound.

OFF:

The CINEMA SURROUND function switches off.

RETURN + button

You can set a channel you frequently view to the Return Channel and you can view that channel at any time with one-touch.

To set the channel to the Return Channel:

1 Select the channel you want to set to the Return Channel.

2 Press this button and hold until the message “RETURN PLUS PROGRAMMED!” appears.

- When you turn off the TV, the Return Channel setting is cancelled.

To view the Return Channel:

Press this button.

- You can view two channels (current channel and Return Channel) alternately by pressing this button.

To cancel the Return Channel setting:

Press this button and hold until the message “RETURN PLUS CANCELLED!” appears.

If no channel is set to the Return Channel:

You can view the channel selected right before the current channel by pressing this button.

DISPLAY button

You can continuously display the current channel number or VIDEO mode on the screen.

Press this button.

To turn the display off, press this button again.

- When selecting a VIDEO mode with no signal, indication of the VIDEO mode becomes fixed on the screen.

MUTING button

You can turn the sound off instantly.

Press this button.

To turn the sound on, press this button again.

Using the TV's menus

This TV has a number of functions you can operate using the menus. To use all your TV's functions fully, you need to understand how to use the menus.

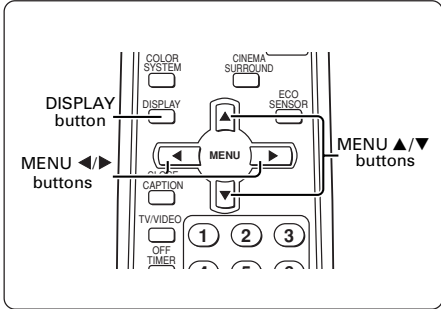

4 Press the MENU ◀/▶ buttons to change function settings.

Example:

Changes the AUTO SHUTOFF setting.

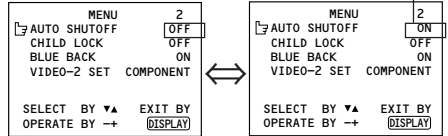

- With some functions, the operation method may differ.

Basic operation

1 Press the MENU ▲/▼ buttons. One of the 5 menus is displayed.

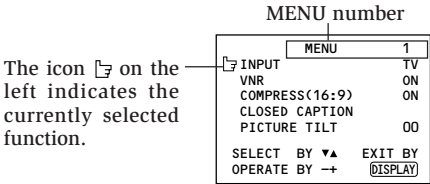

2 Repeatedly press the MENU ▲/▼ buttons to display a desired menu.

- If you hold down the ▼ button, the next menu is displayed.
- If the selected function is on the first line, pressing the ▲ button displays the preceding menu.

3 Repeatedly press the MENU ▲/▼ buttons to select a desired function.

5 Press the DISPLAY button to turn the display off.

- To operate a menu using the buttons on the front panel of the TV, refer to “Operating menus” on page 18.

Using the TV's menus

INPUT

You can view images from VCRs or other devices connected to your TV.

- 1 Press **MENU ▲/▼** to display the "MENU 1" menu, then select "INPUT".

MENU		1
INPUT	TV	
VNR	ON	
COMPRESS(16:9)	ON	
CLOSED CAPTION		
PICTURE TILT	00	
SELECT BY ▼▲	EXIT BY	
OPERATE BY →	DISPLAY	

- 2 Press **MENU ◀/▶** to select the "VIDEO-1", "VIDEO-2" or "VIDEO-3" mode.

TV mode changes to VIDEO mode.

To return to TV mode, repeat step 1 and 2 and set to TV mode.

PICTURE TILT

< AV-29W33 and AV-29W33B only >

There are cases where the Earth's magnetic force may make the picture tilt. If this happens, you can correct the picture tilt.

- 1 Press **MENU ▲/▼** to display the "MENU 1" menu, then select "PICTURE TILT".

MENU		1
INPUT	TV	
VNR	ON	
COMPRESS(16:9)	ON	
CLOSED CAPTION		
PICTURE TILT	00	
SELECT BY ▼▲	EXIT BY	
OPERATE BY →	DISPLAY	

- 2 Continue pressing **MENU ◀/▶** until the picture becomes level.

VNR

You can reduce picture noise.

- 1 Press **MENU ▲/▼** to display the "MENU 1" menu, then select "VNR".

MENU		1
INPUT	TV	
VNR	ON	
COMPRESS(16:9)	ON	
CLOSED CAPTION		
PICTURE TILT	00	
SELECT BY ▼▲	EXIT BY	
OPERATE BY →	DISPLAY	

- 2 Press **MENU ◀/▶** to select "ON".

To cancel the VNR function, select "OFF".

COMPRESS (16:9)

This function converts a normal picture (4:3 aspect ratio) into a wide picture (16:9 aspect ratio).

Use for pictures with a 16:9 aspect ratio that have been squeezed into a normal picture (4:3 aspect ratio), to restore their original dimensions.

- 1 Press **MENU ▲/▼** to display the "MENU 1" menu, then select "COMPRESS (16:9)".

MENU		1
INPUT	TV	
VNR	ON	
COMPRESS(16:9)	ON	
CLOSED CAPTION		
PICTURE TILT	00	
SELECT BY ▼▲	EXIT BY	
OPERATE BY →	DISPLAY	

- 2 Press **MENU ◀/▶** to select "ON".



To cancel the COMPRESS (16:9) function, select "OFF".

Using the TV's menus

CLOSED CAPTION

You can view closed captions or text information.

- 1 Press **MENU ▲/▼** to display the "MENU 1" menu, then select "CLOSED CAPTION".

MENU	1
INPUT	TV
VNR	ON
COMPRESS(16:9)	ON
CLOSED CAPTION	ON
PICTURE TILT	00
SELECT BY ▼▲	EXIT BY
OPERATE BY →←	DISPLAY

- 2 Press **MENU ◀/▶**.

The sub-menu is displayed.

CAPTION:CC1 CC2 CC3 CC4	
TEXT :T1 T2 T3 T4	
SELECT BY ▼▲	EXIT BY
OPERATE BY →←	DISPLAY

- 3 Press **MENU ▲/▼** to select "CAPTION" or "TEXT".
- 4 Press **MENU ◀/▶** to select the caption or text channel.

CHILD LOCK

You can disable the front control buttons of the TV.

When this function is set to "ON", the TV can be operated using only the remote control. Use this function to prevent children from operating the TV without parental consent.

- 1 Press **MENU ▲/▼** to display the "MENU 2" menu, then select "CHILD LOCK".

MENU	2
AUTO SHUTOFF	ON
CHILD LOCK	ON
BLUE BACK	ON
VIDEO-2 SET	COMPONENT
SELECT BY ▼▲	EXIT BY
OPERATE BY →←	DISPLAY

- 2 Press **MENU ◀/▶** to select "ON".

To cancel the CHILD LOCK function, select "OFF".

- The CHILD LOCK function is canceled when you turn the power off.

BLUE BACK

You can mute the sound and change the picture into a blue screen while no signals are received by the TV, or when the signals are unstable.

- 1 Press **MENU ▲/▼** to display the "MENU 2" menu, then select "BLUE BACK".

MENU	2
AUTO SHUTOFF	ON
CHILD LOCK	ON
BLUE BACK	ON
VIDEO-2 SET	COMPONENT
SELECT BY ▼▲	EXIT BY
OPERATE BY →←	DISPLAY

- 2 Press **MENU ◀/▶** to select "ON".

To cancel the BLUE BACK function, select "OFF".

- To view a broadcast even when the reception signal is poor, set the BLUE BACK function to "OFF".
- Even when the BLUE BACK function is set to "OFF", the sound may not be audible.

AUTO SHUTOFF

You can set your TV to turn off if no signals are received for about 15 minutes or longer after the end of a broadcast.

- 1 Press **MENU ▲/▼** to display the "MENU 2" menu, then select "AUTO SHUTOFF".

MENU	2
AUTO SHUTOFF	ON
CHILD LOCK	ON
BLUE BACK	ON
VIDEO-2 SET	COMPONENT
SELECT BY ▼▲	EXIT BY
OPERATE BY →←	DISPLAY

- 2 Press **MENU ◀/▶** to select "ON".

To cancel the AUTO SHUTOFF function, select "OFF".

- The AUTO SHUTOFF function does not turn off the TV's main power.
- The AUTO SHUTOFF will not work for a VIDEO mode.

Using the TV's menus

VIDEO-2 SET

Set the VIDEO-2 SET correctly according to the video signal input from the external device connected to the VIDEO-2 terminal. If this setting is incorrect, images will not be displayed.

- 1 Press MENU ▲/▼ to display the "MENU 2" menu, then select "VIDEO-2 SET".

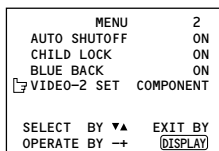

- 2 Set the VIDEO-2 SET according to the video signal input from the VIDEO-2 terminal.

If a normal video signal (composite video signal) is input:

Press the MENU ◀/▶ buttons to select "VIDEO".

If a component video signal (Y/C_B/C_R signals) is input:

Press the MENU ◀/▶ buttons to select "COMPONENT".

AUTO CH PRESET

You can automatically preset all TV channels that can be received by your TV to channels.

- 1 Press MENU ▲/▼ to display the "MENU 3" menu, then select "AUTO CH PRESET".

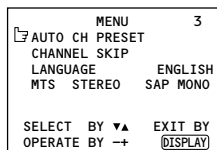

- 2 Press MENU ◀/▶ .

The sub-menu is displayed.

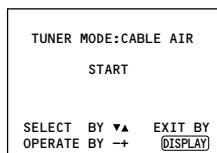

- 3 Press MENU ◀/▶ to select "CABLE" or "AIR".

- 4 Press MENU ▲/▼ to select "START".

- 5 Press MENU ◀/▶ to start the AUTO CH PRESET function.

">>> ON SEARCH" is displayed on the screen.

When all the TV channels that can be received on your TV have been preset, the display goes out and the AUTO CH PRESET function operation is completed.

To stop the AUTO CH PRESET:

Press the MENU ◀/▶ button.

Using the TV's menus

CHANNEL SKIP

You can set undesired channels to be skipped. Channels set to be skipped cannot be selected by the CHANNEL $-/+$ buttons nor the CHANNEL SCAN button.

- 1 Press MENU $\blacktriangle/\blacktriangledown$ to display the "MENU 3" menu, then select "CHANNEL SKIP".

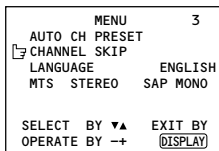

- 2 Press MENU $\blacktriangleleft/\blacktriangleright$.

The sub-menu is displayed.

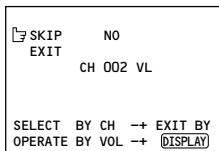

- 3 Press CHANNEL $-/+$ to select the channel you want to skip.
- 4 Press VOLUME $-/+$ to select "YES".
The channel is set to be skipped.
To cancel the CHANNEL SKIP function, select "NO".
- 5 Repeat steps 3 and 4 if you want to set another channel to skip.

To turn the display off:

- 1 Press MENU \blacktriangledown to select "EXIT".

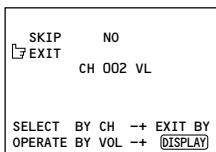

- 2 Press VOLUME $-/+$ to turn the display off.

LANGUAGE

You can select the language for the on-screen display.

- 1 Press MENU $\blacktriangle/\blacktriangledown$ to display the "MENU 3" menu, then select "LANGUAGE".

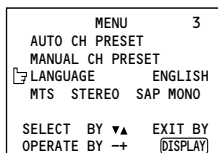

- 2 Press MENU $\blacktriangleleft/\blacktriangleright$ to select language.

The on-screen display indications are in the selected language.

MTS

< Stereo model only >

You can select a MTS (Multi-Channel Television Sound) setting for stereo, mono and SAP (Second Audio Programs).

- 1 Press MENU $\blacktriangle/\blacktriangledown$ to display the "MENU 3" menu, then select "MTS".

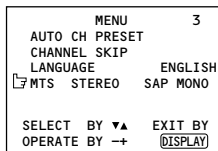

- 2 Press MENU $\blacktriangleleft/\blacktriangleright$ to select the mode.

- Select "MONO" to reduce excess noise in a program or channel.

Using the TV's menus

Picture Adjustments

You can adjust the picture as you like.

- 1 Press **MENU ▲/▼** to display the "MENU 4" menu.

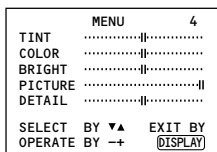

- 2 Press **MENU ▲/▼** to select an item and press **MENU ◀/▶** to adjust it.

TINT* - : Reddish + : Greenish
COLOR - : Lighter + : Deeper
BRIGHT - : Darker + : Brighter
PICTURE - : Lower + : Higher
DETAIL - : Softer + : Sharper

* TINT (tint) is displayed only when viewing images from NTSC 3.58 or NTSC 4.43 color systems.

Sound Adjustments

You can adjust the sound as you like.

- 1 Press **MENU ▲/▼** to display the "MENU 5" menu.

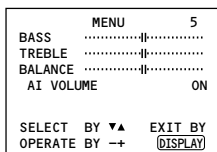

- 2 Press **MENU ▲/▼** to select an item and press **MENU ◀/▶** to adjust it.

TREBLE - : Weaker + : Stronger
BASS - : Weaker + : Stronger
BALANCE - : Left + : Right

AI VOLUME

You can prevent the sudden increase or decrease of volume that occurs when changing channels or switching VIDEO modes.

- 1 Press **MENU ▲/▼** to display the "MENU 5" menu, then select "AI VOLUME".

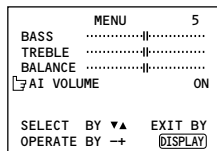

- 2 Press **MENU ◀/▶** to select "ON".

To cancel the AI VOLUME function, select "OFF".

- The AI VOLUME function may not operate as expected if the sound input level from a broadcast station (or video software) is extremely low.
- The AI VOLUME function for TV mode and VIDEO mode can be set separately. For example, you can set it to be off in TV mode and on in VIDEO mode. If you set the AI VOLUME function while viewing a TV channel, the setting is registered as the setting for TV mode. If you set the AI VOLUME function while viewing images from a VIDEO terminal, the setting is registered as the setting for VIDEO mode.

Attaching the Twin Port Bass Blaster Unit

< AV-21W33B/AV-25L33B/AV-29W33B only >

The Twin Port Bass Blaster Unit is packaged together with the TV. Before you use the TV, mount the unit correctly on the TV.

Note:

- The SUPER BASS functions do not work unless the Twin Port Bass Blaster Unit is connected correctly to the TV. For details on the SUPER BASS functions, see page 8.

CAUTION:

- The Twin Port Bass Blaster Unit is just placed on top of the TV and is not held in place by a screw. When you use the unit, pay attention to the following cautions. Otherwise, the unit or TV may fall over and be damaged, or cause unexpected injury.
 - Do not rest your hands or elbows on the unit.
 - Do not move the TV with the Twin Port Bass Blaster Unit mounted on top of the TV. Before you move the TV, be sure to remove the unit.
 - Do not move the TV by holding the Twin Port Bass Blaster Unit.

- 1 Place the unit on top of the TV making sure that the mounting pin on the bottom of the Twin Port Bass Blaster Unit fits into the mounting hole on the top of the TV.**

- When you mount the unit, make sure that the mounting pin fits properly into the mounting hole. Otherwise, it may slide off the top of the TV. This may cause damage or cause unexpected injury.

- 2 Firmly insert the Twin Port Bass Blaster Unit connector into the BASS SPEAKER OUT terminal.**

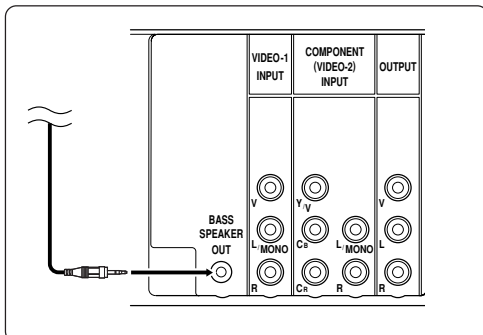
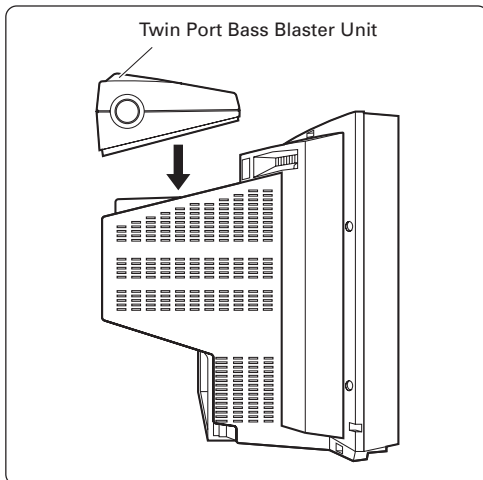

TV buttons and parts

Front

< AV-29W33 and AV-29W33B >

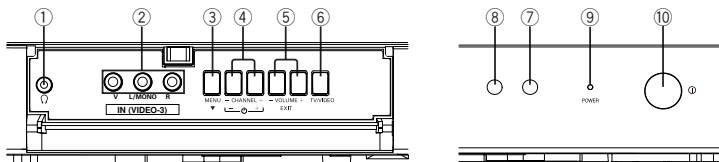

< AV-25L33 and AV-25L33B >

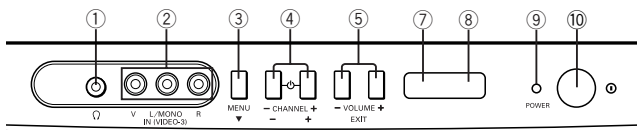

< AV-21W33 and AV-21W33B >

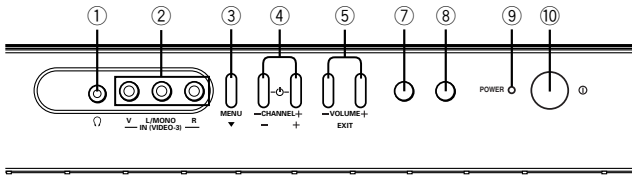

- | | |
|-----------------------|-------------------------|
| ① Headphone jack | ⑥ TV/VIDEO button |
| ② VIDEO-3 terminal | ⑦ ECO sensor |
| ③ MENU button | ⑧ Remote control sensor |
| ④ CHANNEL +/- buttons | ⑨ POWER lamp |
| ⑤ VOLUME +/- buttons | ⑩ Main power button |

Rear

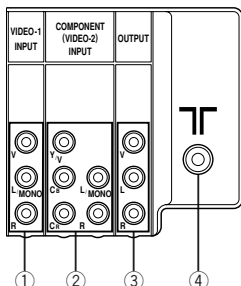

- | |
|--------------------------------------|
| ① VIDEO-1 INPUT terminal |
| ② COMPONENT (VIDEO-2) INPUT terminal |
| ③ OUTPUT terminal |
| ④ Antenna socket |

Using the buttons on the TV

Basic operation

• Check to make sure the CHILD LOCK function is set to “OFF”. When the CHILD LOCK function is set to “ON”, the TV cannot be operated using the front control buttons. For details, see “CHILD LOCK” on page 12.

- 1 Press CHANNEL **-/+** to turn the TV on from standby mode.
- 2 Press CHANNEL **-/+** to select a channel.
- 3 Press VOLUME **-/+** to adjust the volume.
- 4 To turn your TV off, press the Main power button to turn off the TV’s main power.

To change the TV mode to the VIDEO mode:

- Press the TV/VIDEO button if the TV has one. See page 7.
- If the TV has no TV/VIDEO button, select the VIDEO mode with the INPUT function in “MENU 1”.

Operating menus

You can operate functions in menus using the front control buttons on the TV.

- 1 Press MENU **▼** to display a menu.
- 2 Press MENU **▼** repeatedly to display the menu you want to use.
- 3 Press MENU **▼** to select the desired function or item.
- 4 Press MENU **◀/▶** or VOLUME **-/+** to carry out the desired operation.
For details, see the description for each function.
- 5 Press VOLUME **-/+** to turn the menu display off.

Troubleshooting

If there is no picture or the TV does not operate normally, make sure the problem isn't due to the reasons indicated below.

If the problem persists even after taking the measures indicated, please contact a service technician.

Cannot turn the TV on

- Press the Main power button on the TV.
- Connect the power cord to the AC outlet.

The screen turns blue

- Is the BLUE BACK function on? (see page 12.)

Remote control inoperable

- Replace the batteries. (see page 3.)

Buttons on front of the TV do not work

- Switch the CHILD LOCK function off. (see page 12.)

TV does not respond immediately

- Press the main power button on the TV to turn off the main power. Press the main power button again to turn on the TV. If the TV returns to a normal state, operation is normal.

The TV turns off suddenly

- Is the OFF TIMER function set to operate? (see page 8.)
- Is the AUTO SHUTOFF function on? (see page 12.)

Poor sound

- Adjust the sound settings. (see page 15.)

Poor picture

- Press the COLOR SYSTEM button to select another color system. (see page 8.). However, color system cannot be changed in TV mode.
- Adjust the picture settings. (see page 15.)
- Is a component signal output device, such as a DVD player, connected correctly? (see page 5.)
- Is the "VIDEO-2 SET" function setting correct? (see page 13.)
- If noise (snow) totally blocks out the picture, check the following.
 - Have the TV and antenna been connected properly?
 - Has the antenna cable been damaged?
 - Is the antenna pointing in the right direction?
 - Is the antenna itself faulty?
- If the TV or antenna suffer interference from other equipment, stripes or noise may appear in the picture. Move any equipment which can cause interference away from the TV.
- If the TV or antenna suffer interference from signals reflecting from mountains or buildings, double-pictures (ghosting) will occur. Change the antenna's direction or replace it with an antenna with better directionality.
- When a white and bright still image (such as a white dress) is displayed on the screen, the white part may look as if it is colored. When the image disappears from the screen, the unnatural colors will also disappear.

The picture is tilted

< AV-29W33 and AV-29W33B only >

- A picture may be tilted due to the influence of the earth's magnetism. In this case, use the PICTURE TILT function to adjust the tilt. (see page 11.)

Screen is 80% black

- Press the CLOSED CAPTION button to select "OFF". (see page 8.)

Specifications

TV RF systems

M, N

Color systems

NTSC 3.58 (in TV mode only)

NTSC 3.58/NTSC 4.43, PAL (in VIDEO mode only)

Channels

VHF low channel (VL), VHF high channel (VH), UHF channel (U)

Receives cable channels in mid band, super band and hyper band.

External input / output

VIDEO-1: VIDEO input, AUDIO L/R input

VIDEO-2/COMPONENT: VIDEO input, AUDIO L/R input,
COMPONENT VIDEO (Y/C_B/C_R) input

VIDEO-3: VIDEO input, AUDIO L/R input

OUTPUT: VIDEO output, AUDIO L/R output

Headphone jack: stereo mini jack (3.5 mm diameter)

Sound-multiplex systems < Stereo models only >

MTS (Multi-Channel Television Sound)

Design and specifications subject to change without notice.

JVC

VICTOR COMPANY OF JAPAN, LIMITED