



COLOUR TELEVISION

- AV-29J314
- AV-29J534
- AV-29V314
- AV-29V514
- AV-29V534

- AV-25V314
- AV-25V514

- AV-21V314
- AV-21V514
- AV-21V534
- AV-21W314

EQUALIZER • CINEMA SURROUND • COMPONENT INPUT

Contents

Knowing your TV's features	3
Remote control buttons and basic functions	4
TV buttons and functions	6
Setting up your TV	7
Basic setting for picture	9
Advanced setting for picture	11
Basic setting for sound	12
Advanced setting for sound	13
Favorite channel and video setting	14
Customized setting	15
TV channel presetting	17
Additional preparation	20
Troubleshooting	22
Specifications	23

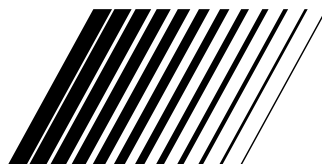

INSTRUCTIONS

Thank you for buying this JVC colour television.
To make sure you understand how to use your new TV, please read this manual thoroughly before you begin.

WARNING: TO PREVENT FIRE OR SHOCK HAZARD, DO NOT EXPOSE THIS APPLIANCE TO RAIN OR MOISTURE.

CAUTION: TO ENSURE PERSONAL SAFETY, OBSERVE THE FOLLOWING RULES REGARDING THE USE OF THIS TV.

- 1 Operate only from the power source indicated on the rear of the TV.
- 2 Avoid damaging the power cord and mains plug. When unplugging the TV, grasp the mains plug. Do not pull on the power cord.
- 3 Never block or cover the ventilation openings.
Never install the TV where good ventilation is unattainable.
When installing this TV, leave spaces for ventilation around the TV of more than the minimum distances as shown.

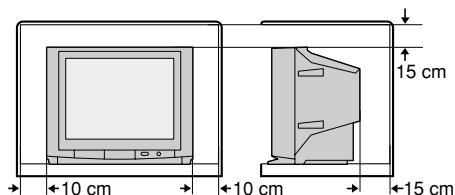

- 4 Do not allow objects or liquid into the cabinet openings.
- 5 In the event of a fault, unplug the unit and call a service technician. Do not attempt to repair it yourself or remove the rear cover.
- 6 The surface of the TV screen is easily damaged. Be very careful with it when handling the TV. Should the TV screen become soiled, wipe it with a soft dry cloth. Never rub it forcefully. Never use any cleaner or detergent on it.

- 7 If you are not going to use this TV for a long period of time, be sure to disconnect the AC plug from the AC socket.
- 8 The apparatus shall not be exposed to dripping or splashing and that no objects filled with liquids, such as vases, shall be placed on the apparatus.

WARNING: <AV-21W314 only>

A REMOVABLE PLASTIC COVER IS FIXED TO THE TELEVISION'S FRONT AUDIO/VIDEO CONNECTOR. TO PREVENT THIS COVER FROM BEING ACCIDENTALLY SWALLOWED BY BABIES OR CHILDREN, REMOVE IT FROM THE TELEVISION AND STORE IT IN A SAFE PLACE. IF THE COVER IS SWALLOWED SEEK THE ADVICE OF A DOCTOR IMMEDIATELY.

Knowing your TV's features

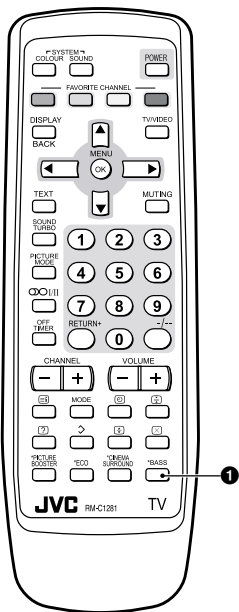

Main features

A2/NICAM (STEREO / I-II)	You can listen to the stereo sound or bilingual sound from TV programme broadcasting by A2 or NICAM Sound-multiplex system.
FAVORITE CH (Channel)	You can register up to four favorite channels for quick recall with one press.
AI ECO	TV detects the brightness of your room and automatically adjust the picture brightness to a suitable level for a better eye care.
AI VOLUME	TV adjusts the volume automatically to the same level for all TV channels to avoid sudden change of the volume when selecting different TV channel.
VNR	You can reduce the picture noise when viewing noisy TV programmes or video sources.
WHITE BALANCE	You can choose one of three tones of white to match the video source such as movie, sports, etc. Changing WHITE BALANCE affects the appearance of all other colours on the screen.

Confirm your TV's functions

Some functions written in this instruction manual may not be available for your TV. Please see the chart below and check the functions that are equipped for your TV's model number. The model number is indicated at the rear of your TV. When you press a button concerned to a function that is not available for your TV, it does not work and the logo "Ø" appears on the screen. For a function that is not available for your TV, it is not displayed in the menu.

No.	Function	Model No.										
		AV-29V534	AV-29J534	AV-29V514	AV-29V314	AV-29J314	AV-25V514	AV-25V314	AV-21V514	AV-21V314	AV-21W314	AV-21V534
①	*BASS	○	—	—	—	—	—	—	—	—	—	○
—	PICTURE TILT	○	○	—	—	—	—	—	—	—	—	—

Remote control buttons and basic functions

No.	Press	To
1	POWER	Turn on or off the TV from standby mode.
2	MENU/OK	Display menu and confirm selected function.
3	▲ / ▼ / ◀ / ▶	Select and adjust menu function.
4	CHANNEL +/-	Select the desired channel number.
5	VOLUME +/-	Adjust the volume level.
6	TV/VIDEO	Select TV or video terminal input.
7	MUTING	Turn off the volume. Press this button again to resume the volume.
8	DISPLAY	Display the programme number or video terminal number, stereo/bilingual broadcast system and PR list (channel list) on the screen. You can select the channel using the PR list. 1 Press the DISPLAY button once to display the PR list. 2 Press ▲ / ▼ / ◀ / ▶ buttons to choose a channel, then press the MENU/OK button. You can confirm the favorite channels in the PR list. The channels set to favorite channels are indicated with coloured mark.
9	0~9, -/--	Select the programme number. For two digits programme number, press -/--, then press the number button.
10	RETURN +	a) Return to the frequently view channel with one touch. 1 Choose the channel you want to register. 2 Press and hold RETURN+ button until "RETURN PLUS PROGRAMMED!" appears. To cancel, press and hold RETURN+ button until "RETURN PLUS CANCELED!" appears. b) Return to the previously viewed channel, if you have not set or have cancelled the Return channel as above.

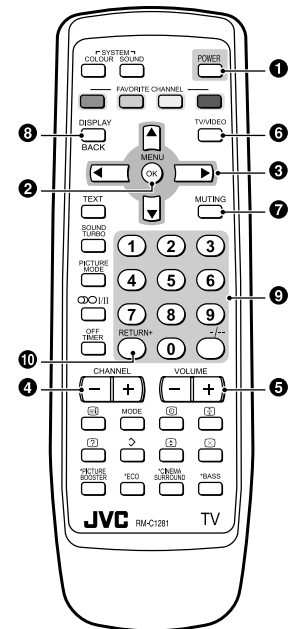

Remote control buttons and basic functions (continued)

How to operate menus and menu locations

To	Operation	Note
Display the MENU	Press the MENU/OK button ②.	To exit the MENU, press the DISPLAY button ③ or choose EXIT menu.
Display the top menu	Press ▲/▼ buttons ③ to choose a menu title. Then press MENU/OK button ②.	Press ▼ button ③ to display the next page for more functions.
Display the 2nd menu	Press ▲/▼ buttons ③ to choose a menu title. Then press MENU/OK button ②.	
Display the 3rd menu	Press ▲/▼ buttons ③ to choose a menu title. Then press MENU/OK button ②.	
Return to the previous menu	Press the DISPLAY button ③.	—
Choose the setting of a function	Press ▲/▼ buttons ③ to choose a function. Then press the ◀/▶ buttons ③ to change the setting.	Press the MENU/OK button ② to exit from the menu.
Adjust the effect level of a function	Press ▲/▼ buttons ③ to choose a function. Then press the ◀/▶ buttons ③ to adjust the effect level.	
Display the sub menu of a function.	Press the ▲/▼ buttons ③ to choose a function. Then press MENU/OK buttons ② to display the sub menu.	—

The following chart shows locations of functions in menus. In this manual, location of a function is described as follows:

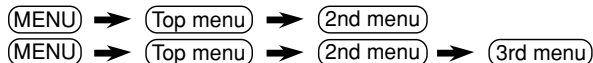

Note: Some functions have the 4th menus as the sub-menus.

	Top menu	2nd menu	Location	3rd menu	Location	
MENU	INPUT	EXT. INPUT	P.16	—	—	
		DISPLAY	P.16	—	—	
	PICTURE * If you want to adjust PICTURE SETTING menu, you must set PICTURE MODE menu to USER.	PICTURE MODE	P.9	—	—	
		PICTURE SETTING	P.10	—	—	
		WHITE BALANCE	P.10	—	—	
		PICTURE FEATURES	—	—	VNR	P.15
			—	—	FAVORITE CH SETTING	P.14
	—		—	VIDEO SETTING	P.14	
	—		—	COLOUR SYSTEM	P.9	
	—	—	COMPRESS (16:9)	P.11		
	—	—	PICTURE TILT	P.11		
	SOUND * If you want to adjust EQUALIZER menu, you must set SOUND MODE menu to USER.	STEREO/!J	P.13	—	—	
		AI VOLUME	P.13	—	—	
		SOUND MODE	P.12	—	—	
		EQUALIZER	P.13	—	—	
		BALANCE	P.12	—	—	
		SOUND TURBO	P.12	—	—	
	FEATURES	CINEMA SURROUND	P.13	—	—	
		SUPER BASS	P.12	—	—	
		OFF TIMER	P.15	—	—	
CHILD LOCK		P.15	—	—		
INSTALL	AI ECO SENSOR	P.11	—	—		
	AUTO PROGRAM	P.17	—	—		
	EDIT/MANUAL	P.17	DELETE, MOVE, MANUAL, INSERT	P.17- P.18		
	LANGUAGE	P.17	LANGUAGE	P.15		
	BLUE BACK	P.11	—	—		
	AUTO SHUTOFF	P.18	—	—		
	VIDEO-2 SETTING	P.18	—	—		
AI ECO DISPLAY	P.11	—	—			
EXIT	—	—	—	—		

TV buttons and functions

The illustrations shown below is for 29V and 29J series only, which are used for explanation purpose. Your TV may not look exactly the same as illustrated.

Front of the TV

29V Series

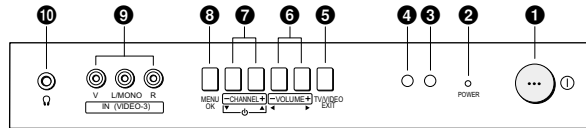

29J Series

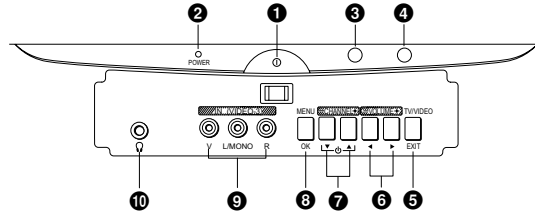

Rear of the TV

For models without Bass

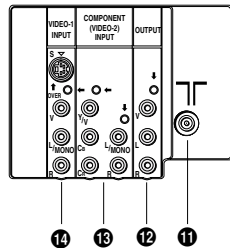

For models with Bass

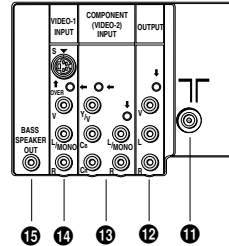

No.	Button/terminal	Description	Page
①	① (main power)	Press to turn on or turn off the TV's main power.	-
②	POWER lamp	Indicate the TV is being turned on or off. No colour: TV's main power is being turned off. Red : TV's main power is being turned on. Note: When you turn off the power switch while TV is in standby mode, the light of power lamp will be off in 10 -15 seconds.	-
③	ECO sensor		-
④	Remote control sensor		-
⑤	TV/ VIDEO	Press to select TV or video mode.	-
⑥	VOLUME +/-	Press to adjust the volume level.	-
⑦	CHANNEL +/-	Press to select the desired channel.	-
⑧	MENU	Press to display the menu.	-
⑨	IN (VIDEO-3)	Video and audio input jacks for VIDEO-3 mode.	20
⑩	Headphone jack.		20
⑪	Aerial socket.		7
⑫	OUTPUT	Video and audio output jacks. (The component video signal cannot be output.)	20
⑬	COMPONENT (VIDEO-2) INPUT	Video or component video, and audio input jacks for VIDEO-2 mode. You can select the input signal by setting the "VIDEO-2 SETTING" function (see page 16).	20
⑭	VIDEO-1 INPUT	Video or S-VIDEO, and audio input jacks for VIDEO-1 mode	7
⑮	BASS SPEAKER OUT	Twin Port Bass Blaster Unit output terminal.	21

How to operate the menus with the TV button

TV button	Work as same as the button on the remote control unit	Note
MENU	MENU/OK button	To display main menu and exit menu after finish setting.
CHANNEL +/-	▲/▼ button	To select menu function.
VOLUME +/-	◀▶ button	To adjust the desired function.

Setting up your TV

CAUTION

- Turn off the equipment including the TV before connecting.

1 Connecting the aerial cable.

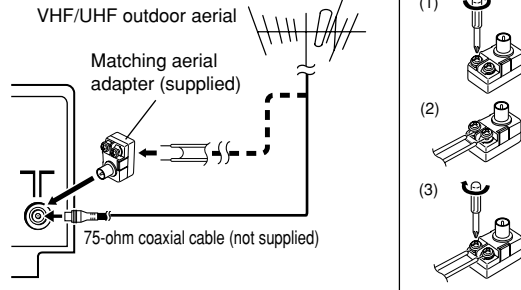

If you connect a VCR, connect the aerial output jack of your VCR and the aerial jack on the TV with the aerial cable. Then connect the output jacks of your VCR and the VIDEO-1 input jacks of the TV with the video cable (or S-VIDEO cable if available) and audio cables. For details, see the manual of your VCR.

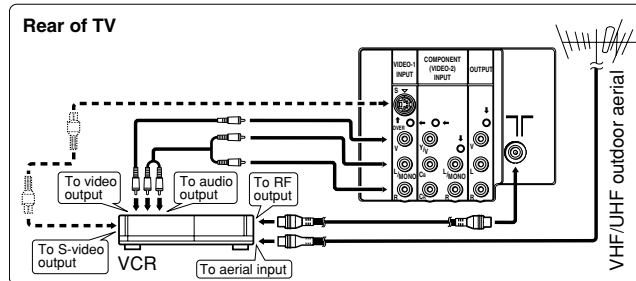

The illustration shown is just a sample. It may not be same as your TV.

2 Connecting the compatible main plug to the AC outlet.

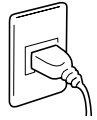

3 Inserting batteries into the remote control.

Insert two batteries by following the ⊕ and ⊖ polarities and inserting the ⊖ end first.

CAUTION:

Follow the cautions printed on the batteries.

Notes:

- Use AA/R6/UM-3 dry cell batteries.
- If the remote control does not work properly, fit new batteries. The supplied batteries are for testing, not regular use.

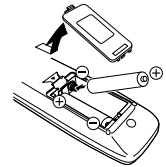

4 Turn on the TV by pressing the main power button.

JVC logo appears on the screen.

JVC

Setting up your TV (continued)

5 Making the initial settings

Set up your TV by pressing MENU/OK button or waiting for 15 seconds, then the TV will operate by following steps as below:

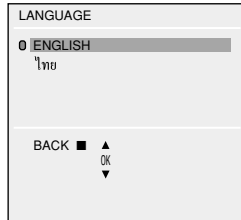

- Press ▲/▼ button to select your desired language.

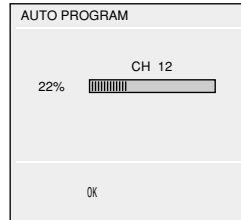

- TV will start searching for the channels.

To stop AUTO PROGRAM, press MENU/OK button.



- Press the red button to cancel the SETUP TOUR RESTART function.
If you want to make initial settings again when the next time you turn on the TV, press the MENU/OK button to activate the SETUP TOUR RESTART function.

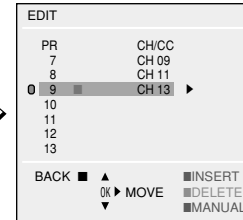

- To complete the initial setting, press the MENU/OK button. To edit the channel list, see page 17.

If the JVC logo does not appear, use LANGUAGE, and AUTO PROGRAM functions to make the initial settings. Those functions are located in the INSTALL menu.

If the JVC logo appears, although you had made the initial settings, press the TV/VIDEO button to exit from initial settings.

Basic setting for picture

COLOUR SYSTEM

You can select the appropriate colour system when the picture is not clear or no colour appears.

Press the COLOUR SYSTEM button to select a setting.

<AV-29J314/AV-29V314/AV-25V314/AV-21V314/AV-21W314>

In TV mode:

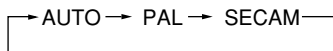

<Other Models>

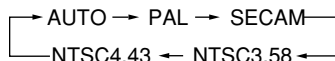

In VIDEO mode:

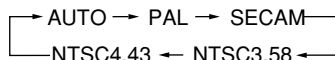

To operate this function with a menu:

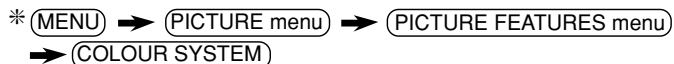

For the colour system in each country or region, see the table below:

Area	Country or Region	System
Asia, Middle East	Bahrain, Kuwait, Oman, Qatar, United Arab Emirates, Yemen, etc.	PAL
	Indonesia, Malaysia, Singapore, Thailand, India, etc.	PAL
	China, Vietnam, etc.	PAL
	Hong Kong, etc.	PAL
	Islamic Republic of Iran, Lebanon, Saudi Arabia, etc.	SECAM
Europe	Philippines, Taiwan, Myanmar, etc.	NTSC
	Russia, etc.	SECAM
	Czech Republic, Poland, etc.	PAL
	Germany, Holland, Belgium, etc.	PAL
Oceania	UK, etc.	PAL
	Australia, New Zealand, etc.	PAL
Africa	Republic of South Africa, etc.	PAL
	Nigeria, etc.	PAL
	Egypt, Morocco, etc.	SECAM

PICTURE MODE

You can choose the desired picture setting with one-touch.

Press the PICTURE MODE button to select a setting.

SOFT	Softens contrast and sharpness.
BRIGHT	Heightens contrast and sharpness.
STANDARD	Standard picture setting.
USER	You can change this picture setting as you like. Select USER and adjust following items in the PICTURE SETTING menu. (CONTRAST, BRIGHT, SHARP, COLOUR, TINT*)

*TINT can only be adjusted in NTSC system.

To operate this function with a menu:

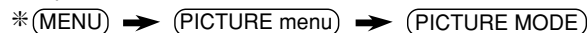

To return the USER setting to the default, press the blue button when the PICTURE SETTING menu appears.

* About the basic operations of the menu, please see the "How to operate menus and menus locations" on page 5.

Basic setting for picture (continued)

Adjusting the picture - USER

You can adjust the desired picture setting when selecting USER in PICTURE MODE.

1 Select the USER in PICTURE MODE under PICTURE menu.

* (MENU) → (PICTURE menu) → (PICTURE MODE)
→ (USER)

2 Select the PICTURE SETTING in PICTURE menu, then adjust the setting.

* (MENU) → (PICTURE menu) → (PICTURE SETTING)

CONTRAST	◀ : Lower contrast	▶ : Higher contrast
BRIGHT	◀ : Darker	▶ : Brighter
SHARP	◀ : Softer	▶ : Higher
COLOUR	◀ : Lighter	▶ : Deeper
TINT*	◀ : Reddish	▶ : Greenish

*TINT can only be adjusted in NTSC system.

WHITE BALANCE

You can change the white balance of the picture to better match the type of video being viewed.

Select the WHITE BALANCE in the PICTURE menu, then choose the desired setting.

* (MENU) → (PICTURE menu) → (WHITE BALANCE)

NORMAL	Normal white balance.
COOL	Bluish white.
WARM	Reddish white.

* About the basic operations of the menu, please see the “How to operate menus and menu locations” on page 5.

Advanced setting for picture

AI ECO SENSOR (ECO)

You can adjust TV screen contrast according to the brightness of your room.

Press the ECO button to select the desired mode.

1	Mild contrast (recommended).
2	Even contrast.
OFF	Cancel the function.

To operate this function with a menu:

* (MENU) → (FEATURES menu) → (AI ECO SENSOR)

You can display the graphic of AI ECO SENSOR on the screen. Select the AI ECO DISPLAY in the INSTALL menu, then choose ON or OFF.

* (MENU) → (INSTALL menu) → (AI ECO DISPLAY)

Correcting the Slanting Picture (PICTURE TILT)

You can correct the picture tilt caused by the earth's magnetic force.

1 Select the PICTURE TILT in the PICTURE FEATURES menu under PICTURE menu, then press MENU/OK button.

* (MENU) → (PICTURE menu) → (PICTURE FEATURES menu) → (PICTURE TILT)

The following display appears.

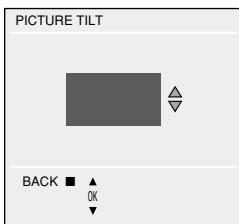

2 Press the ▲/▼ buttons until the picture become level. Then press the MENU/OK button.

COMPRESS (16:9)

You can convert a normal picture (4:3 aspect ratio) into a wide picture (16:9 aspect ratio).

Select the COMPRESS (16:9) in the PICTURE FEATURES menu under PICTURE menu, then choose ON or OFF.

* (MENU) → (PICTURE menu) → (PICTURE FEATURES menu) → (COMPRESS (16:9))

BLUE BACK

You can set the TV to automatically change to a blue screen and mute the sound if the signal is weak or absent, or when there is no input from an antenna.

Select the BLUE BACK in the INSTALL menu, then choose ON or OFF.

* (MENU) → (INSTALL menu) → (BLUE BACK)

If you wish to continue viewing the poor picture, cancel the BLUE BACK function.

* About the basic operations of the menu, please see the “How to operate menus and menus locations” on page 5.

Basic setting for sound

SOUND SYSTEM

You can select an appropriate sound system when abnormal sound occurs even when the picture appears normally. Press the SOUND SYSTEM button to select a setting.

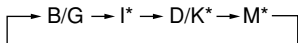

* The sound system of I, D/K and M are not available for 314 series.

This function is not available in video mode.

For the sound system in each country or region, see the table below:

Area	Country or Region	System
Asia, Middle East	Bahrain, Kuwait, Oman, Qatar, United Arab Emirates, Yemen, etc.	B/G
	Indonesia, Malaysia, Singapore, Thailand, India, etc.	B/G
	China, Vietnam, etc.	D/K
	Hong Kong, etc.	I
	Islamic Republic of Iran, Lebanon, Saudi Arabia, etc.	B/G
Europe	Philippines, Taiwan, Myanmar, etc.	M
	Russia, etc.	D/K
	Czech Republic, Poland, etc.	D/K
	Germany, Holland, Belgium, etc.	B/G
	UK, etc.	I
Oceania	Australia, New Zealand, etc.	B/G
Africa	Republic of South Africa, etc.	I
	Nigeria, etc.	B/G
	Egypt, Morocco, etc.	B/G

SUPER BASS (BASS)

You can enjoy powerful bass sound with the Twin Port Bass Blaster unit.

Press the BASS button to select ON or OFF.

To operate this function with a menu:

* (MENU) ➔ (SOUND menu) ➔ (SUPER BASS)

For attaching the Twin Port Bass Blaster unit, please see in page 21.

SOUND MODE

You can choose the desired sound setting.

Select the SOUND MODE in SOUND menu, then choose the setting.

* (MENU) ➔ (SOUND menu) ➔ (SOUND MODE)

USER	You can change this sound setting as you like. Select USER and adjust the frequencies in EQUALIZER (100, 300, 1K, 3K, 8K Hz). For details, see "EQUALIZER" on page 13.
DYNAMIC	Emphasize on both vocal sound and music.
MUSIC	Emphasize on music effect.
NEWS	Emphasize on vocal sound.

BALANCE

You can adjust the volume balance between the left and right speakers.

Select the BALANCE in SOUND menu, then adjust the setting.

* (MENU) ➔ (SOUND menu) ➔ (BALANCE)

SOUND TURBO

You can enjoy the emphatic low and high frequency levels.

Press the SOUND TURBO to select ON or OFF.

To operate this function with a menu:

* (MENU) ➔ (SOUND menu) ➔ (SOUND TURBO)

* About the basic operations of the menu, please see the "How to operate menus and menus locations" on page 5.

Advanced setting for sound

CINEMA SURROUND

You can enjoy an enhanced sound for wider audience.
Press the CINEMA SURROUND button to select a setting.

OFF	Cancel the function.
LOW	Listen to sound with less wider audience effect.
HIGH	Listen to sound with more wider audience effect.
MONO	Listen to mono sound with stereo effect.

To operate this function with a menu:



* (MENU) → (SOUND menu) → (CINEMA SURROUND)

If slight volume distortion occurs when you select HIGH mode, change the setting to LOW mode. The CINEMA SURROUND effect will be less noticeable.

If you use CINEMA SURROUND and SOUND TURBO together, volume distortion might occur.

STEREO / I-II (I/II)

You can enjoy the stereo and bilingual broadcasted programmes.
Press the  I/II button to select the desired mode.

	Select stereo sound.
	Select monaural sound.
I	Select bilingual I (sub I).
II	Select bilingual II (sub II).
MONO	Cancel the Multi Sound function, and the sound becomes monaural.

This function is not available in video mode.

To operate this function with a menu:

* (MENU) → (SOUND menu) → (STEREO / I-II)

EQUALIZER

You can adjust the sound level of each frequencies when selecting USER mode in SOUND MODE.

1 Select the USER in SOUND MODE under SOUND menu.

* (MENU) → (SOUND menu) → (SOUND MODE) → (USER)

2 Select the EQUALIZER in SOUND menu.

* (MENU) → (SOUND menu) → (EQUALIZER)

The following display appears.

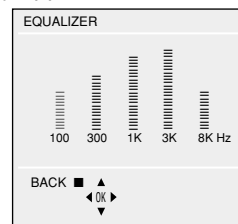

3 Select and adjust the desired frequencies.

4 Press the MENU/OK button to exit the menu.

Adjust high frequency will affect higher pitch sound and vice versa.

AI VOLUME

You can adjust the volume of all the channels and video inputs to the same level automatically.

Select the AI VOLUME in SOUND menu, then choose ON or OFF.

* (MENU) → (SOUND menu) → (AI VOLUME)

* About the basic operations of the menu, please see the “How to operate menus and menus locations” on page 5.

Favorite channel and video setting

To register the favorite channel

You can register and recall 4 favorite channels by using the colour buttons (red, green, yellow, blue).

- 1 In TV mode, select a TV channel (PR01-99) you desired to register.
- 2 Press and hold a colour button for 3 seconds or more.
“FAVORITE CHANNEL ■ PROGRAMMED!” appears on the screen and current channel is registered.
- 3 To register other favorite channels, repeat Step 1 to 2.
To recall the favorite channel, press the colour button.
When the TV is in menu mode, favorite channel function is not available.

To adjust favorite channel setting (FAVORITE CH SETTING)

You can adjust the picture and sound settings for the favorite channels.

- 1 Display the PICTURE menu and select FAVORITE CH SETTING in PICTURE FEATURES menu.
* (MENU) → (PICTURE menu) → (PICTURE FEATURES menu) → (FAVORITE CH SETTING)
- 2 Select FAVORITE CHANNEL in FAVORITE CH SETTING menu, then choose the desired favorite channel.
* (FAVORITE CH SETTING) → (FAVORITE CHANNEL)
- 3 Select EFFECT, then press ◀▶ button to choose ON.
To cancel the settings, choose OFF.

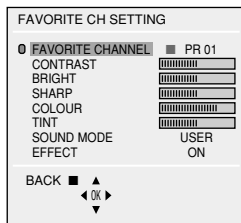

- 4 Select the desired item that you wish to adjust.

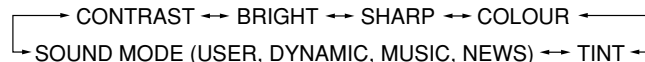

- 5 Press the MENU/OK button to exit the menu.

To adjust the video setting (VIDEO SETTING)

You can adjust the picture and sound settings for video inputs.

- 1 Display the PICTURE menu and select VIDEO SETTING in PICTURE FEATURES menu.
* (MENU) → (PICTURE menu) → (PICTURE FEATURES menu) → (VIDEO SETTING)
- 2 Select VIDEO STATUS in VIDEO SETTING menu, then choose the desired video input.
* (VIDEO SETTING) → (VIDEO STATUS)
- 3 Select EFFECT, then press ◀▶ button to choose ON.
To cancel the settings, choose OFF.

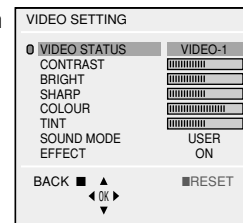

- 4 Select the desired item that you wish to adjust.

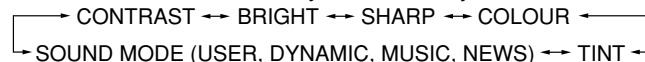

- 5 Press the MENU/OK button to exit the menu.

* About the basic operations of the menu, please see the “How to operate menus and menus locations” on page 5.

Customized setting

VNR

You can reduce the noise.

Select the VNR in the PICTURE FEATURES menu under PICTURE menu, then choose a setting of VNR function.

* (MENU) → (PICTURE menu) → (PICTURE FEATURES menu)
→ (VNR)

OFF	VNR is turned off.
AUTO	Effect of VNR is automatically controlled.
MIN	Effect of VNR becomes minimum level.
MAX	Effect of VNR becomes maximum level.

If you select MAX, the picture becomes softer even if the original picture is sharp.

LANGUAGE

You can choose your desired on screen display language.

Select the LANGUAGE in the INSTALL menu, then choose a language.

* (MENU) → (INSTALL menu) → (LANGUAGE)

CHILD LOCK

You can disable the front control buttons of the TV.

Select the CHILD LOCK in the FEATURES menu, then choose ON or OFF.

* (MENU) → (FEATURES menu) → (CHILD LOCK)

OFF TIMER

You can set the TV to turn off automatically to standby mode after a set time.

Press the OFF TIMER button to select a desired period of time.

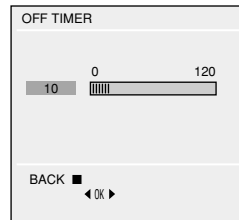

You can set the period of time to a maximum of 120 minutes in 10 minutes step.

To operate this function with a menu:

* (MENU) → (FEATURES menu) → (OFF TIMER)

When the elapsed of time left one minute, "GOOD NIGHT!" appears on the screen.

You can display the OFF TIMER menu again to confirm or change the remaining time.

* About the basic operations of the menu, please see the "How to operate menus and menus locations" on page 5.

Customized setting (continued)

AUTO SHUTOFF

You can set the TV to turn off automatically when no signal is received for about 15 minutes or longer after the end of a broadcast.

Select AUTO SHUTOFF in INSTALL menu, then choose ON or OFF.

* (MENU) ➔ (INSTALL menu) ➔ (AUTO SHUTOFF)

The AUTO SHUTOFF function does not turn off the TV's main power.

The AUTO SHUTOFF function is not available in video mode.

VIDEO-2 SETTING

You can set the VIDEO-2 SETTING according to the video signal output from the external devices connected to the VIDEO-2 terminal.

Select the VIDEO-2 SETTING in INSTALL menu, then choose a setting.

* (MENU) ➔ (INSTALL menu) ➔ (VIDEO-2 SETTING)

VIDEO If a normal video signal (composite video signal) is input.

COMPONENT If a component video signal (Y/Cb/Cr) is input.

For connecting methods, see "Additional Preparation" on page 20.

* About the basic operations of the menu, please see the "How to operate menus and menus locations" on page 5.

EXT. INPUT (TV/VIDEO)

You can select TV or video terminal input with one touch.

Press the TV/VIDEO button to select an input.

To operate this function with a menu:

* (MENU) ➔ (INPUT menu) ➔ (EXT. INPUT)

DISPLAY

You can display the programme number, video terminal number and PR list on the screen.

Press the DISPLAY button to select the desired mode:

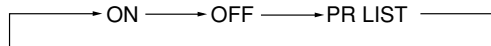

Choose a TV channel or a VIDEO terminal.

- 1 Press the DISPLAY button to display the PR LIST.
- 2 Select a programme number or video terminal by pressing the ▲/▼ button to move up/down on the programme number or press the ◀/▶ button to skip for each 7 programme numbers, then press MENU/OK button.

PR LIST		
PR		CH/CC
AV		
1	■	CH 03
2	■	CH 05
3	■	CH 07
4	■	CH 09
5		CC 04
6		CC 05

▲
-7 ◀ 00 ▶ +7
▼

To operate this function with a menu:

* (MENU) ➔ (INPUT menu) ➔ (DISPLAY)

* About the basic operations of the menu, please see the "How to operate menus and menus locations" on page 5.

TV channel presetting

To register the TV channels automatically

You can register the TV channels into the TV's channel list automatically.

- 1 Display the INSTALL menu.

* (MENU) ➔ (INSTALL menu)

- 2 Choose AUTO PROGRAM, then press the MENU/OK button. AUTO PROGRAM function starts, and the channels received are registered in the channel list (PR list) automatically.

- 3 "SETUP TOUR RESTART?" appears.

To start the SETUP TOUR	Press the MENU/OK button. Then proceed to step 5 of "Setting up your TV" on page 8.
-------------------------	---

To skip the SETUP TOUR	Press the Red button.
------------------------	-----------------------

- 4 The EDIT menu appears.

To edit the channel list	Proceed to the Step 3 of "To edit the channel list (PR LIST)" on page 18.
--------------------------	---

If a channel is not registered	Proceed to the Step 3 of "To register the TV channels manually" on this page.
--------------------------------	---

To exit the menu	Press the MENU/OK button.
------------------	---------------------------

For details of "SETUP TOUR", see page 8.

To register the TV channels manually (MANUAL in the EDIT menu)

You can register the TV channels into the TV's channel list manually.

- 1 Display the INSTALL menu.

* (MENU) ➔ (INSTALL menu)

- 2 Choose EDIT/MANUAL, then press the MENU/OK button. EDIT menu appears.

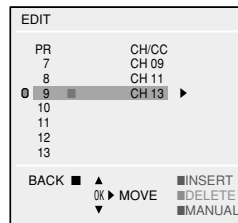

- 3 Choose the channel which you want to register.
 - 4 Press the blue button to activate the MANUAL function. The sound system of the channel appears at the right of the CH/CC number.
 - 5 Press the ► button to choose an appropriate sound system. For details, see "SOUND SYSTEM" on page 12.
 - 6 Press the green or red button to search for the TV channel. Searching stops when a channel is found and displayed.
 - 7 Repeat step 5 until your desired TV channel appears
- | | |
|--------------------------|--|
| If the reception is poor | Press the blue or yellow button to fine tune the TV channel. |
| If noisy sound is heard | Press the ► button to choose an appropriate sound system. |
- 8 Press the MENU/OK button to exit the menu.

* About the basic operations of the menu, please see the "How to operate menus and menus locations" on page 5.

TV channel presetting (continued)

To edit the channel list (PR LIST) (MOVE and DELETE in the EDIT menu)

You can edit the TV channel list as you like.

Note: After this operation, other channel's PR numbers will be changed.

- 1 Display the INSTALL menu.

* (MENU) ➔ (INSTALL menu)

- 2 Choose EDIT/MANUAL, then press the MENU/OK button. EDIT menu appears.

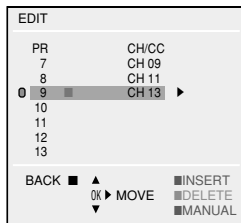

- 3 Choose the channel which you want to change PR number, or delete.

- 4 Do the following action:

To change the PR number (MOVE)	Press the ▶ button. Then move it to the PR number you want to use it for the channel. Finally press the ◀ button.
--------------------------------	---

To delete the channel (DELETE)	Press the yellow button.
--------------------------------	--------------------------

- 5 Press the MENU/OK button to exit the menu.

To add in the new channel (INSERT in the EDIT menu)

You can add in the new channel in the TV channel list as you like. You need to find the “CH/CC” number for the TV channel. Find the “CH/CC” number corresponding to the channel number of the TV channel from the attached sheet “CH/CC number list” on page 19.

- 1 Display the INSTALL menu.

* (MENU) ➔ (INSTALL menu)

- 2 Choose EDIT/MANUAL, then press the MENU/OK button. EDIT menu appears.

- 3 Choose the PR number for which you will register a new TV channel. When you add a new TV channel of NTSC-M system, press the SOUND SYSTEM button to change the sound system to M. Then proceed to the next step.

- 4 Press the green button, then press ▲/▼ buttons to choose “CC” or “CH”.

- 5 Press the number button to enter the remaining CH/CC number.

The TV starts to search the TV channel, and the picture of the TV channel appears. If the TV finds no TV channel, a noisy picture appears.

When a TV channel has already been registered in PR99, using the INSERT function deletes that TV channel.

* About the basic operations of the menu, please see the “How to operate menus and menus locations” on page 5.

TV channel presetting (continued)

CH/CC number

When you want to use the INSERT function on page 18, find the CH/CC number corresponding to the channel number of the TV channel from this table.

Channel No. Country

US United States, Philippines, etc..

CCIR Middle East, Southeast Asia, etc..

OIRT Eastern Europe, Russia, Vietnam, etc..

AUSTRALIA Australia, etc..

Channel

CH	US	CCIR	OIRT	AUSTRALIA
CH 02	US-2	E2	R1	AU-0
CH 03	US-3	E3		AU-1
CH 04	US-4	E4	R2	AU-2
CH 05	US-5	E5	R6	AU-6
CH 06	US-6	E6	R7	AU-7
CH 07	US-7	E7	R8	AU-8
CH 08	US-8	E8	R9	AU-9
CH 09	US-9	E9		
CH 10	US-10	E10	R10	AU-10
CH 11	US-11	E11	R11	AU-11
CH 12	US-12	E12	R12	
CH 13	US-13			
CH 14	US-14, W+29			
CH 15	US-15, W+30			
CH 16	US-16, W+31			
CH 17	US-17, W+32			
CH 18	US-18, W+33			
CH 19	US-19, W+34			
CH 20	US-20, W+35			
CH 21	US-21, W+36	E21		
CH 22	US-22, W+37	E22		
CH 23	US-23, W+38	E23		
CH 24	US-24, W+39	E24		
CH 25	US-25, W+40	E25		
CH 26	US-26, W+41	E26		
CH 27	US-27, W+42	E27		
CH 28	US-28, W+43	E28		
CH 29	US-29, W+44	E29		
CH 30	US-30, W+45	E30		
CH 31	US-31, W+46	E31		
CH 32	US-32, W+47	E32		

CH	US	CCIR	OIRT	AUSTRALIA
CH 33	US-33, W+48	E33		
CH 34	US-34, W+49	E34		
CH 35	US-35, W+50	E35		
CH 36	US-36, W+51	E36		
CH 37	US-37, W+52	E37		
CH 38	US-38, W+53	E38		
CH 39	US-39, W+54	E39		
CH 40	US-40, W+55	E40		
CH 41	US-41, W+56	E41		
CH 42	US-42, W+57	E42		
CH 43	US-43, W+58	E43		
CH 44	US-44, W+59	E44		
CH 45	US-45, W+60	E45		
CH 46	US-46, W+61	E46		
CH 47	US-47, W+62	E47		
CH 48	US-48, W+63	E48		
CH 49	US-49, W+64	E49		
CH 50	US-50, W+65	E50		
CH 51	US-51, W+66	E51		
CH 52	US-52, W+67	E52		
CH 53	US-53, W+68	E53		
CH 54	US-54, W+69	E54		
CH 55	US-55, W+70	E55		
CH 56	US-56, W+71	E56		
CH 57	US-57, W+72	E57		
CH 58	US-58, W+73	E58		
CH 59	US-59, W+74	E59		
CH 60	US-60, W+75	E60		
CH 61	US-61, W+76	E61		
CH 62	US-62, W+77	E62		
CH 63	US-63, W+78	E63		
CH 64	US-64, W+79	E64		
CH 65	US-65, W+80	E65		
CH 66	US-66, W+81	E66		
CH 67	US-67, W+82	E67		
CH 68	US-68, W+83	E68		
CH 69	US-69, W+84	E69		

CC	US	CCIR	OIRT	AUSTRALIA
CC 01		S-1		AU-5
CC 02		S-2		
CC 03		S-3		
CC 04		S-4		
CC 05		S-5		
CC 06		S-6		AU-5A
CC 07		S-7		
CC 08		S-8		
CC 09		S-9		
CC 10		S-10		
CC 11		S-11		
CC 12		S-12		
CC 13		S-13		
CC 14	A	S-14		
CC 15	B	S-15		
CC 16	C	S-16		
CC 17	D	S-17		

CC	US	CCIR	OIRT	AUSTRALIA
CC 18	E	S-18		
CC 19	F	S-19		
CC 20	G	S-20		
CC 21	H	S-21		
CC 22	I	S-22		
CC 23	J	S-23		
CC 24	K	S-24		
CC 25	L	S-25		
CC 26	M	S-26		
CC 27	N	S-27		
CC 28	O	S-28		
CC 29	P	S-29		
CC 30	Q	S-30		
CC 31	R	S-31		
CC 32	S	S-32		
CC 33	T	S-33		
CC 34	U	S-34		
CC 35	V	S-35		
CC 36	W	S-36		
CC 37	W+1	S-37		
CC 38	W+2	S-38		
CC 39	W+3	S-39		
CC 40	W+4	S-40		
CC 41	W+5	S-41		
CC 42	W+6			
CC 43	W+7			
CC 44	W+8			
CC 45	W+9			
CC 46	W+10			
CC 47	W+11			
CC 48	W+12			
CC 49	W+13			
CC 50	W+14			
CC 51	W+15			
CC 52	W+16			
CC 53	W+17			
CC 54	W+18			
CC 55	W+19			
CC 56	W+20			
CC 57	W+21			
CC 58	W+22			
CC 59	W+23			
CC 60	W+24			
CC 61	W+25			
CC 62	W+26			
CC 63	W+27			
CC 64	W+28			
CC 75		X		
CC 76		Y	R3	
CC 77		Z	R4	AU-3
CC 78		Z+1	R5	
CC 79		Z+2		AU-4
CC 95	A-5			
CC 96	A-4			
CC 97	A-3			
CC 98	A-2			
CC 99	A-1			

Additional preparation

The illustrations shown in this section are for 29V and 29J series only, which are used for explanation purpose. Your TV may not look exactly the same as illustrated.

Before connecting

- Read the manuals provided with the devices for the proper connection.
- Turn off all the devices including the TV.
- Note that connecting cables are not supplied.

Connecting to front video input terminal

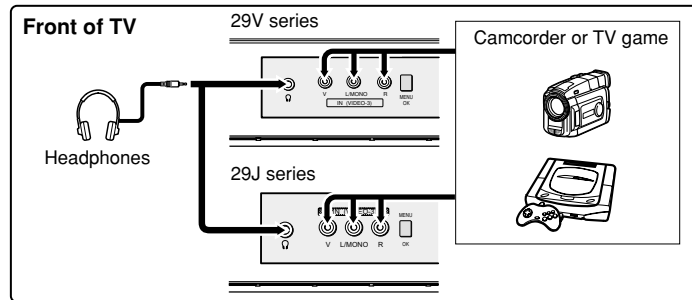

Connecting to rear component/video input terminal and output terminal

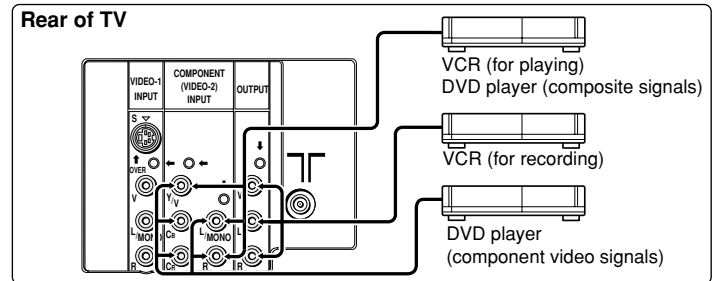

When you use VIDEO-1 INPUT, you should choose to connect S-VIDEO or video input. If S-VIDEO connector and video input are connected at the same time, no picture displays on the screen and the message "PLEASE DISCONNECT VIDEO-1 CABLE!" appears. In this case, you should disconnect either S-VIDEO or video input.

When connecting to COMPONENT (VIDEO-2) input, depending on the connection, choose the appropriate video input using the menu (see page 16).

Additional preparation (continued)

Attaching the Twin Port Bass Blaster Unit

<AV-29J534/AV-29V534/AV-21V534 only>

The Twin Port Bass Blaster Unit is packaged together with the TV. Before you use the TV, mount the Twin Port Bass Blaster unit correctly on the TV.

- The SUPER BASS (BASS) function do not work unless the Twin Port Bass Blaster Unit is connected correctly to the TV. For details on the SUPER BASS (BASS) function, see page 12.
- 1 Place the unit on top of the TV making sure that the mounting pin on the bottom of the unit fits into the mounting hole on the top of the TV.
 - When you mount the unit, make sure that the mounting pin fits properly into the mounting hole. Otherwise, it may slide off the top of the TV. This may cause damage or cause unexpected injury.

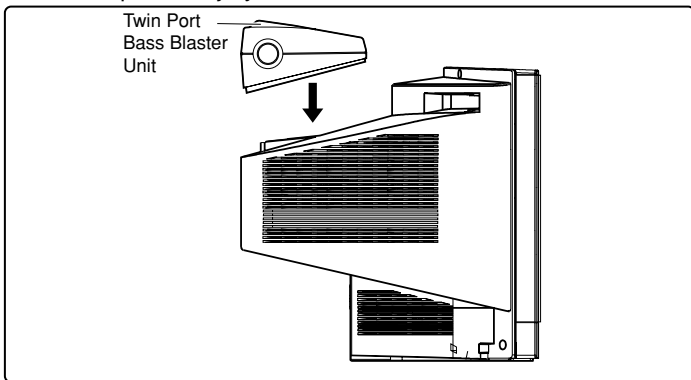

- 2 Firmly insert the Twin Port Bass Blaster Unit connector into the BASS SPEAKER OUT terminal.

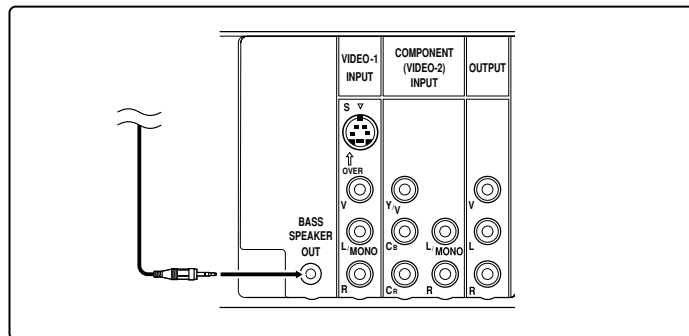

CAUTION:

The Twin Port Bass Blaster Unit is just placed on top of the TV and is not held in place by a screw. When using the unit, pay attention to the following cautions. Otherwise, the unit or TV may fall over and be damaged, or cause unexpected injury.

- Do not rest your hands or elbows on the Twin Port Bass Blaster Unit.
- Do not move the TV with the Twin Port Blaster Unit mounted on top of the TV. Before you move the TV, be sure to remove the unit.
- Do not move the TV by holding the Twin Port Bass Blaster Unit.

Troubleshooting

If a problem occurs when you are using the TV, check the below troubleshooting guide before calling for repair.

• No picture, no sound	• Deactivate the BLUE BACK function if it is turned on. • Choose the appropriate sound system. Refer to "SOUND SYSTEM" on page 12.
• Snowy picture	• Check the aerial cable and its connection with the TV.
• Stripes appear on the picture	• Interference occurs caused by other devices such as an amplifier, personal computer, or a hair drier. Move such devices away from your TV.
• Double-pictures (ghosting) occur	• Interference occurs caused by signal reflecting from mountains or building. Try to adjust the aerial's direction or use a better directionality antenna.
• Poor picture	• Choose the appropriate colour system. Refer to "COLOUR SYSTEM" on page 9. • Adjust the COLOUR or BRIGHT setting. Refer to "Adjusting the picture - USER" on page 10.
• White and bright still image look as if it were coloured	• Inevitable phenomenon due to the nature of the picture tube. This is not a malfunction.
• Top of the image from software products or video tape is distorted	• This is due to the condition of the video signal whereby the image was not recorded properly. This is not a malfunction.
• Poor sound	• Adjust the sound frequency properly. Refer to "EQUALIZER" on page 13.
• Stereo or bilingual sound is unclear	• TV channel reception is poor. Change the stereo/ bilingual mode to mono sound (see page 13).

• Cannot operate the remote control	• The batteries may be exhausted. Replace with new batteries (see page 7). • Ensure that you are operating the remote less than seven meters from the front of your TV.
• Cannot operate the menus	• Press TV/VIDEO button to return to TV mode and try operating the menus.
• Cannot operate the front control buttons	• Deactivate the CHILD LOCK function if it is turned on (see page 15).
• TV is turned off suddenly	• This may due to the AUTO SHUT OFF function is activated. Press the POWER button to turn on the TV.
• Colour patches appear at the corner of the screen	• This may due to the magnetized device such as a speaker near to your TV. Keep the device apart from your TV. Alternately, you can also use the magnetic-shielded speaker.
• Picture is tilted	• This may due to the earth magnetism. Refer to "PICTURE TILT" on page 11 to correct the tilt.
• Image takes a short period to be displayed	• Image required time to stabilize before display. This is not a malfunction.
• TV may emitted crackling sound	• This is due to a sudden change in temperature and it is not a malfunction. If the crackling sound is too frequent, request your service technician for inspection.
• Feel a slight electric shock when touching the TV screen	• This is due to the static electricity of the picture tube and it will not harm the human body. This is not a malfunction.

Specifications

Model	AV-29J314	AV-29V314	AV-25V314	AV-21V314	AV-21W314
TV RF system	B, G				
Colour system	(RF mode)	PAL, SECAM			
	(VIDEO mode)	PAL, SECAM, NTSC 3.58 MHz, NTSC 4.43 MHz			
Channel and Frequencies	VHF low channel (VL) : 46.25 to 168.25 MHz VHF high channel (VH) : 175.25 to 463.25 MHz UHF channel (U) : 471.25 to 863.25 MHz *Receives cable channel in mid band (X to Z, S1 to S10), super band (S11 to S20) and hyper band (S21 to S41)				
Power input	AC 110 to 240 V, 50/60 Hz (operating AC 90 to 260 V, 50/60 Hz)				
Power consumption	MAX: 166 W AVG: 109 W	MAX: 166 W AVG: 109 W	MAX: 151 W AVG: 102 W	MAX: 121 W AVG: 81 W	MAX: 121 W AVG: 81 W
Screen size (Measured diagonally)	Picture tube: 727.4 mm Visible area: 676.0 mm	Picture tube: 727.4 mm Visible area: 676.0 mm	Picture tube: 649.0 mm Visible area: 597.0 mm	Picture tube: 546.9 mm Visible area: 508 mm	Picture tube: 546.9 mm Visible area: 508 mm
Audio output (Rated power output)	10 W + 10 W		7 W + 7 W		
Speakers	(6.5 x 13) cm X2				
External input/output	VIDEO-1: S-VIDEO input, VIDEO input, AUDIO L/R input VIDEO-2/COMPONENT: VIDEO input, AUDIO L/R input, COMPONENT VIDEO (Y/C _B /C _R) input VIDEO-3: VIDEO input, AUDIO L/R input OUTPUT: VIDEO output, AUDIO L/R output Headphone jack: Stereo mini jack (3.5 mm diameter)				
Dimension (W x H x D)	731 X 622 X 494.5 mm	812 X 584.2 X 520.5 mm	728 X 536 X 481.5 mm	649 X 465.5 X 473.5 mm	649 X 465.5 X 471.5 mm
Weight	42 kg	41 kg	33 kg	24 kg	24 kg
Accessories	<ul style="list-style-type: none"> • Remote control unit: RM-C1281 X 1 • AA/R6/UM-3 dry cell battery X 2 • Matching aerial adapter X 1 				

Design and specifications subject to change without notice.

Specifications (continued)

Model	AV-29J534	AV-29V534	AV-29V514	AV-25V514	AV-21V534	AV-21V514
TV RF system	B, G, I, D, K, M					
Colour system (RF mode and VIDEO mode)	PAL, SECAM, NTSC 3.58 MHz, NTSC 4.43 MHz					
Channel and Frequencies	VHF low channel (VL) : 46.25 to 168.25 MHz VHF high channel (VH) : 175.25 to 463.25 MHz UHF channel (U) : 471.25 to 863.25 MHz *Receives cable channel in mid band (X to Z, S1 to S10), super band (S11 to S20) and hyper band (S21 to S41)					
Power input	AC 110 to 240 V, 50/60 Hz (operating AC 90 to 260 V, 50/60 Hz)					
Power consumption	MAX: 215 W AVG: 130 W	MAX: 215 W AVG: 130 W	MAX: 166 W AVG: 109 W	MAX: 151 W AVG: 102 W	MAX: 143 W AVG: 91 W	MAX: 121 W AVG: 81 W
Screen size (Measured diagonally)	Picture tube: 727.4 mm Visible area: 676.0 mm	Picture tube: 727.4 mm Visible area: 676.0 mm	Picture tube: 727.4 mm Visible area: 676.0 mm	Picture tube: 649.0 mm Visible area: 597.0 mm	Picture tube: 546.9 mm Visible area: 508 mm	Picture tube: 546.9 mm Visible area: 508 mm
Audio output (Rated power output)	7 W + 7 W + 13 W		10 W + 10 W	7 W + 7 W	7 W + 7 W + 13 W	7 W + 7 W
Speakers	(6.5 x 13) cm X 2 (Ø 13) cm X 1		(6.5 x 13) cm X 2		(6.5 x 13) cm X 2 (Ø 13) cm X 1	(6.5 x 13) cm X 2
External input/output	VIDEO-1: S-VIDEO input, VIDEO input, AUDIO L/R input VIDEO-2/COMPONENT: VIDEO input, AUDIO L/R input, COMPONENT VIDEO (Y/C _B /C _R) input VIDEO-3: VIDEO input, AUDIO L/R input OUTPUT: VIDEO output, AUDIO L/R output Headphone jack: Stereo mini jack (3.5 mm diameter)					
Dimension (W x H x D)	731 X 622 X 494.5 mm	812 X 584.2 X 520.5 mm	812 X 584.2 X 520.5 mm	728 X 536 X 481.5 mm	649 X 478 X 473.5 mm	649 X 465.5 X 473.5 mm
Weight	44.4 kg	43.4 kg	41 kg	33 kg	26.4 kg	24 kg
Accessories	<ul style="list-style-type: none"> • Remote control unit: RM-C1281 X 1 • AA/R6/UM-3 dry cell battery X 2 • Matching aerial adapter X 1 					

Design and specifications subject to change without notice.

JVC