



JVC

AV-28KT1BUF
AV-28KT1SUF

ENGLISH
FRANÇAIS
DEUTSCH
ITALIANO
CASTELLANO
NEDERLANDS
PORTUGUÊS

JVC
VICTOR COMPANY OF JAPAN, LIMITED

COLOUR TELEVISION

INSTRUCTIONS

TELEVISEUR COULEUR
FARBFERNSEHGERÄT
TELEVISORE A COLORI
TELEVISOR A COLOR
KLEURENTELEVISIE
TELEVISOR A CORES

MANUEL D'INSTRUCTIONS
BEDIENUNGSANLEITUNG
ISTRUZIONI
MANUAL DE INSTRUCCIONES
GEBRUIKSAANWIJZING
INSTRUÇÕES



50038905



0503-JVC



Contents

Safety Precautions	1
Remote Control Buttons	2
Control Panel Buttons	3
Antenna Connections	3
Preparation	4
Features	4
Before Switching on your TV	4
Power connection	4
Aerial Connections	4
How to connect the external equipments	4
Inserting batteries in the remote control handset	4
Switching the TV ON/OFF	4
To switch the TV on	4
To switch the TV off	4
Initial Settings	4
T-V LINK	5
Operating with the onset buttons	6
Operating with Remote Control	6
Menu System	6
Sound Menu	6
Picture Menu	7
Feature Menu	8
Install (Installation) Menu	9
Decoder(EXT-2)	10
Program (Programming) Menu	10
To start Auto Program (AUTOSTORE)	11
Other Features	11
Sound Mute	11
Information on Screen	11
To Display the Time	11
Picture Mode	11
VCR Control Buttons	11
Teletext	12
To operate Teletext	12
To select a page of Teletext	12
To Select Index Page	12
Searching for a teletext page while watching TV	12
To Select Double Height Text	12
To Reveal "concealed" Information	12
To Stop Automatic Page Change	12
To Select a Subcode Page	12
To exit Teletext	12
Fastext and Toptext	12
Connect the External Equipments	13
Via the Euroconnector	13
T-V LINK compatible VCR	13
RGB mode	13
EXT-2S Mode	13
Via the RCA jacks	13
Via the ANT (aerial) socket	13
TV and Video Recorder (VCR)	13
NTSC Playback	13
Copy Facility	13
Connecting Headphones	13
Tips	15
Specifications	15

Safety Precautions

1. Power Source

The receiver should be operated only from a **220-240V AC, 50 Hz.** Outlet. Ensure you select the correct voltage setting for your convenience.

2. Power Cord

The power supply cord should be placed so that they are not likely to be walked on or pinched by items placed upon them or against them. Pay particular attention to cord where they enter the plug, power outlet, and the point where they exit from the receiver.

3. Moisture and Water

Do not use this equipment in a humid and damp place (avoid the bathroom, the sink in the kitchen, and near the washing machine). Do not expose this equipment to rain or water and do not place objects filled with liquids on it as this may be dangerous.

4. Cleaning

Before cleaning, unplug the receiver from the main supply outlet. Do not use liquid or aerosol cleaners. Use with soft and dry cloth.

5. Ventilation

The slots and openings on the receiver are intended for ventilation and to ensure reliable operation. To prevent overheating, these openings must not be blocked or covered in any way.

6. Lightning

In case of storm and lightning or when going on holiday, disconnect the power cord from the wall outlet.

7. Replacement Part

When replacement parts are required, be sure the service technician has used replacement parts which are specified by the manufacturer or have the same specifications as the original one. Unauthorized substitutions may result in fire, electrical shock, or other hazards.

8. Servicing

Please refer all servicing to qualified personnel. Do not remove cover as this may result in electric shock.

9. Flame sources

Do not place naked flame sources on the apparatus.

10. Stand-By

Do not leave your TV stand-by or operating condition when you leave your house.

Warning!

Any intervention contrary to regulations, in particular, any modification of high voltage or a replacement of the picture tube may lead to an increased concentration of x-rays. Any television modified in this way no longer complies with license and must not be operated.

Instructions for waste disposal:

Packaging and packaging aids are recyclable and should principally be recycled. Packaging materials, such as foil bag, must be kept away from children.

Batteries, including those which are heavy metal-free, should not be disposed of with household waste. Please dispose of used batteries in an environmentally sound manner. Find out about the legal regulations which apply in your area.

Remote Control Buttons

- ① = Stand By / Power
- ② **0 - 9** = Direct Program
- ③ **STANDARD** Button (Picture Mode Change)
- ④ Colour Buttons
RED: Zoom (Picture Size) Change
GREEN: Hyper Sound
YELLOW: Factory Settings in Picture Menu
- ⑤ **MENU** = Menu Button
- ⑥ **▲ (P^)** = Cursor Up / Programme Up
- ⑦ **▶ (⇨)** = Cursor Right / Volume +
- ⑧ Teletext Control Buttons
- ⑨ VCR Control Buttons
- ⑩ **▼ (Pv)** = Cursor Down / Programme Down
- ⑪ **◀ (⇧)** = Cursor Left / Volume -
- ⑫ **AV** = AV Button
- ⑬ **i** = Information Button
- ⑭ = Mute

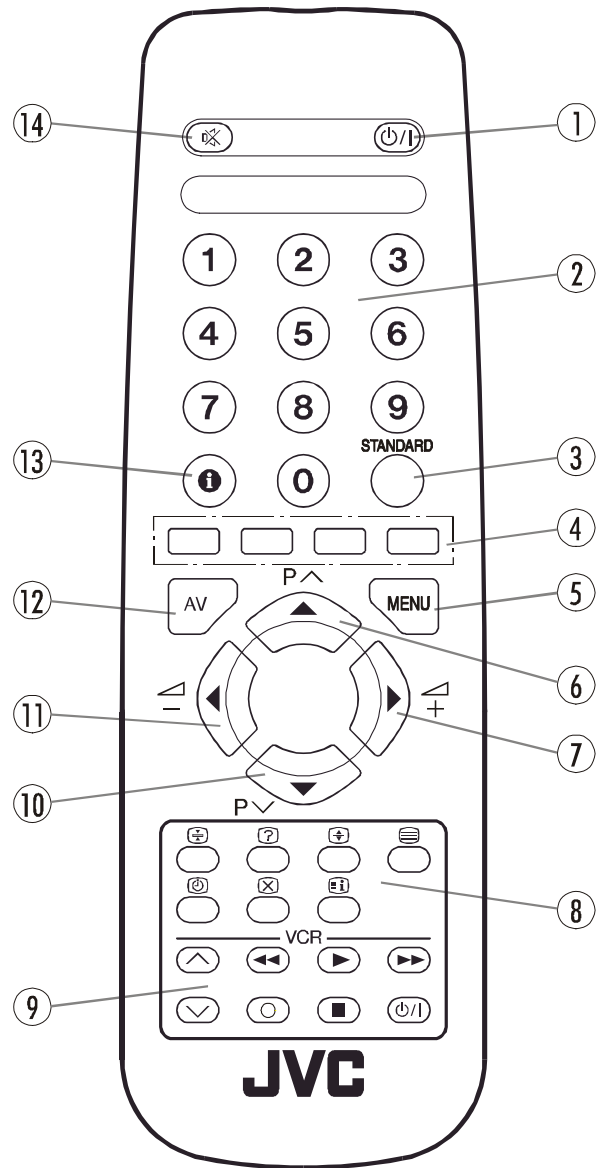

CAUTION
RISK OF ELECTRIC SHOCK



The lightning flash with arrowhead symbol, within an equilateral triangle, is intended to alert the user to the presence of uninsulated "dangerous voltage" within the product's enclosure that may be of sufficient magnitude to constitute a risk of electric shock of persons.

The exclamation point within an equilateral triangle is intended to alert the user to the presence of important operating and maintenance (servicing) instructions in the literature accompanying the appliance.

Control Panel Buttons

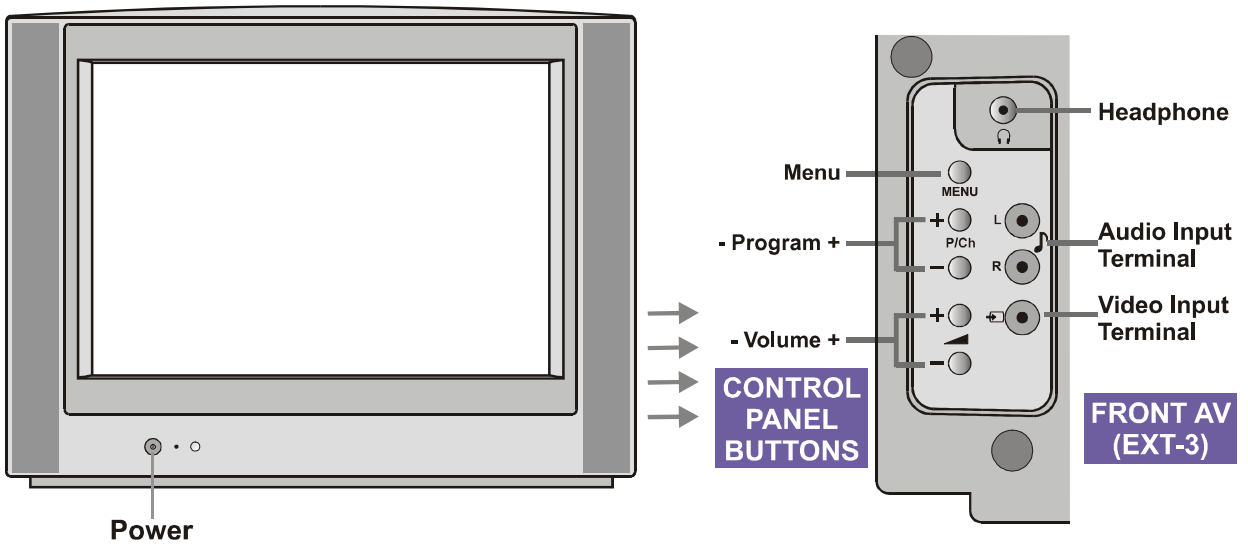

Antenna Connections

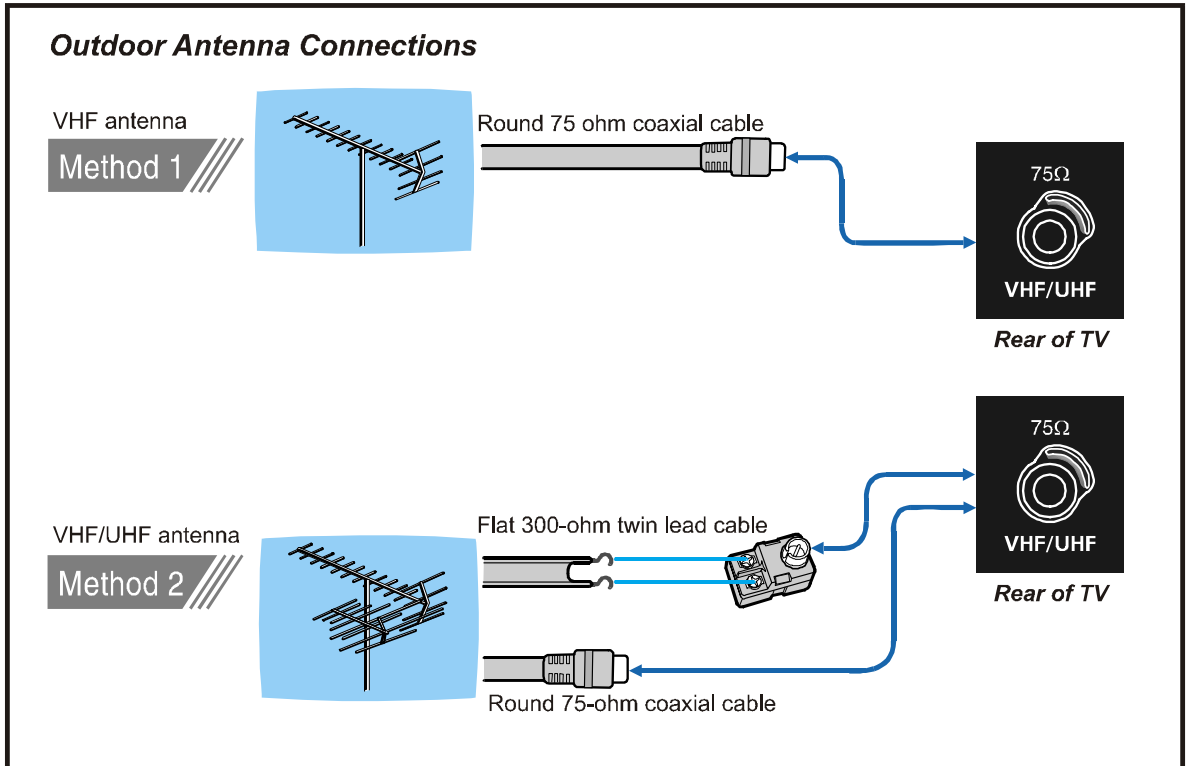

Preparation

Place TV on a solid surface.

For ventilation, leave a space of at least 10 cm free all around the set. To prevent any fault and unsafe situations, please do not place any objects on top of the set.

“Use this apparatus in tropical and moderate climates.”

Features

- It is a remote controlled colour television.
- 100 programmes from VHF, UHF bands or cable channels can be preset.
- It can tune cable channels.
- Controlling the TV is very easy by its menu driven system.
- It has two Euroconnector sockets for external devices (such as video recorder, video games, audio set, etc.)
- Front AV (EXT-3) Input available.
- Stereo sound systems (German+Nicam) are available.
- Full function Teletext (Fastext, Toplevel).
- It is possible to connect headphone.
- Direct channel access.
- AUTO PROGRAM (Automatic Programming System).
- All programmes can be named.
- Forward or backward automatic tuning.
- Sleep timer.
- Child Lock.
- Blue Background.
- T-V Link.
- Automatic sound mute when no transmission.
- When no valid signal is detected, after 5 minutes the TV switches itself automatically to stand-by mode.
- WSS (Wide Screen Signaling).
- NTSC Playback.

Before Switching on your TV

Power connection

Important: The TV set is designed to operate on **220-240 V AC, 50 Hz**.

- After unpacking, allow the TV set to reach the ambient room temperature before you connect the set to the mains.

Aerial Connections

- Connect the aerial plug to the aerial input socket located at the back of the TV.

How to connect the external equipments

See “Connect the External Equipments” on page 14.

- See the instruction manuals provided with the external devices too.

Inserting batteries in the remote control handset

- Remove the battery cover located on the back of the handset by gently pulling upwards from the indicated part.
- Insert two **AA (R6)** or equivalent type batteries inside.
- Replace the battery cover.

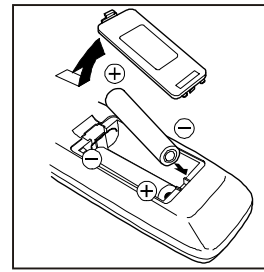

NOTE: Remove batteries from remote control handset when it is not to be used for a long period. Otherwise it can be damaged due to a leakage of batteries.

Switching the TV ON/OFF

You can operate your TV either using the remote control handset or directly using the TV onset buttons.

To switch the TV on

Your TV will switch on in two steps:

- 1- Press the power button located on the front of the TV. Then the TV switches itself to standby mode and the **RED LED** located below the TV turns on.

- 2- To switch on the TV from stand-by mode either:

Press a digit button on the remote control so that a programme number is selected,

or,

Press Standby / Power Button or Programme Up and Down buttons on the TV or on the remote control respectively, so the TV will switch on and the **RED** Led will turn **GREEN**.

To switch the TV off

- Press the stand-by button on the remote control, so the TV will switch to stand-by mode and the **GREEN LED** will become **RED**, or,
- Press the power button located on the front of the TV.

Initial Settings

The message “**PLEASE CHECK ANTENNA CABLE AUTO. PROGRAMMING SYSTEM**” will be displayed when you turn on your TV for the first time.

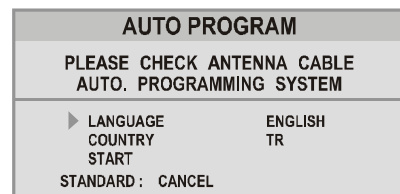

- 1- Select **LANGUAGE** with “P ^” or “P v” button, then press the “◀” or “▶” button to select a menu language.

- 2- Select **COUNTRY** with “P ^” or “P v” button, then press the “◀” or “▶” button to select the country you are now located.

- 3- Select **START** with “P ^” or “P v” button, then press the “right” button to start **AUTO PROGRAM**

AUTO PROGRAM, (Automatic Programming System) automatically programmes the received channels in your TV's programme numbers. During **AUTO PROGRAM**, “**AUTO PROGRAM IS RUNNING PLEASE WAIT**” will be displayed.

After **AUTO PROGRAM** is finalized, the “**PROGRAM**” menu appears.

To cancel **AUTO PROGRAM**, press the “**STANDARD**” button.

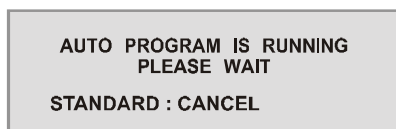

PROGRAM		
01 C 12	11 ----	21 ----
02 C 23	12 ----	22 ----
03 C 45	13 ----	23 ----
04 C 47	14 ----	24 ----
05 C 50	15 ----	25 ----
06 C 55	16 ----	26 ----
07 ----	17 ----	27 ----
08 ----	18 ----	28 ----
09 ----	19 ----	29 ----
10 ----	20 ----	30 ----
NAME	INSERT	
DELETE	AUTOSTORE	
i : T-V LINK		

You can delete a channel, insert a channel into a programme number, or re-start **AUTO PROGRAM** with the “**PROGRAM**” menu. For details, see “**Program (Programming) menu**” on page 10.

4- If you do not have a T-V LINK compatible VCR, press “**STANDARD**” button to exit the menu.

If you have a T-V LINK compatible VCR connected to the **EXT.2** terminal, press “**i**” button to display “**T-V LINK**” menu. Then follow the operating procedure “**Downloading data to VCR**” in the following “**T-V LINK**” section.

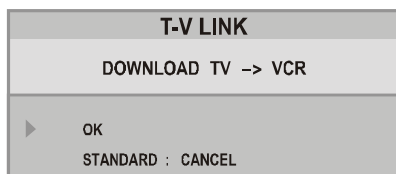

If the message “**PLEASE CHECK ANTENNA CABLE AUTO. PROGRAMMING SYSTEM**” does not appear, or if you want to modify the settings later, you can do manually with the “**FEATURE**”, “**INSTALL**” and “**PROGRAM**” menus.

T-V LINK

When a T-V LINK compatible VCR is connected to the **EXT.2** Terminal on the TV, it is easier to set up the VCR and to view videos. T-V LINK uses the following features:

To use T-V LINK functions:

A “**T-V LINK compatible VCR**” means a JVC video cassette recorder with the T-V LINK logo, or with one of the following logos. However, these VCRs may support some or all of the features described earlier. For details, see your VCR instruction manual.

“**Q-LINK**” (a trademark of Panasonic Corporation)

“**Data Logic**” (a trademark of Metz Corporation)

“**Easy Link**” (a trademark of Phillips Corporation)

“**Megalogic**” (a trademark of Grundig Corporation)

“**SMARTLINK**” (a trademark of Sony Corporation)

Downloading data to VCR:

The VCR will automatically download the registered data on the TV channels from the TV. This means you do not need to set up the programme channels on your VCR manually.

The “**T-V LINK**” menu will be displayed when you press the “**i**” button while “**PROGRAM**” menu is displayed, or whenever the “**INSTALL**” menu operations are performed.

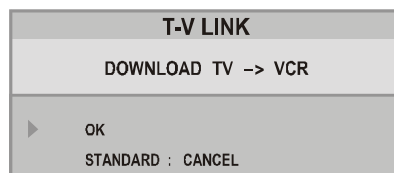

Press “**▶**” button to start downloading data to VCR.

• If you do not want to do, press the “**STANDARD**” button to exit the menu.



When “**FEATURE NOT AVAILABLE...**” is displayed:

If “**FEATURE NOT AVAILABLE...**” is displayed, the download was not performed correctly. Before trying to download again, check that:

- The VCR power is turned on
- The VCR is T-V LINK compatible
- The VCR is connected to the **EXT.2** terminal
- The SCART cable is fully wired.

Direct Rec:

“What You See Is What You Record”

You can easily record to VCR the images that you are watching on the TV. For details, read the manual for your VCR. Use your VCR controls. You cannot carry out Direct Rec using your TV’s control.

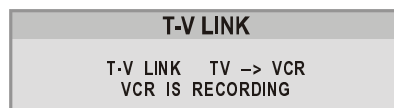

When the VCR is not ready (for example when there is no tape inserted), “**NO RECORDING**” is displayed.

In the following situations, the VCR will stop recording if the TV is turned off, if the TV channel or input is changed, or if the menu is displayed on the TV:

- When recording images from an external device connected to the TV. (for example a camcorder)
- When recording a TV channel after it has been unscrambled on a decoder.
- When recording a TV channel by using the TV’s output because the VCR’s own tuner cannot properly receive that channel.

TV auto power on/VCR image view:

When the VCR starts playing, the TV automatically turns on and the images from **EXT.2 (EXT-2)** terminal appear on the screen.

This function does not happen if your TV’s main power is turned off. Set your TV’s main power to on (standby mode).

Operating with the onset buttons

Volume setting and programme selection can be made using the buttons on the right side of the TV.

Volume Setting:

- Press “-” button to decrease volume or “+” button to increase volume, so a volume level scale will be displayed on the screen.

Programme Selecting:

- Press “**P/Ch+**” button to select next programme or “**P/Ch-**” button to select the previous programme.

Entering Main Menu:

- Press “**MENU**” button to enter main menu. In the main menu select submenu using “**P/Ch+**” or “**P/Ch-**” button and enter the submenu using “+” or “-” button. To learn the usage of the menus, refer to “**Menu System**” on **page 6**.

Operating with Remote Control

The remote control handset of your TV is designed to control all the functions of the model you selected. The functions will be described in accordance with the menu system of your TV.

Functions which you can use out of menu system are described below.

Volume Setting:

Press “+” button to increase volume.

Press “-” button to decrease volume.

Programme Selecting (Previous or next programme):

- Press “**P** ” button to select the previous programme.
- Press “**P** ” button to select the next programme.

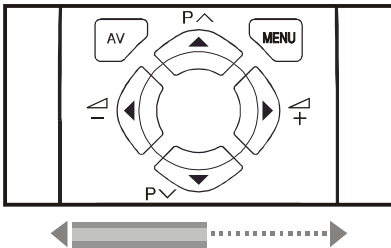

Programme Selecting (direct access):

Press digit buttons on the remote control handset to select programmes between 0 and 9. TV will switch to the selected program after a short delay.

- For a two digit program number enter the second digit after pressing the first digit within 2 seconds.

Menu System

Your TV has been designed with a menu system. Display “**MENU**” (main menu) and enter one of five menus (**SOUND**, **PICTURE**, **FEATURE**, **INSTALL** and **PROGRAM**).

- 1- Press “**MENU**” button to display “**MENU**” (main menu). The menu titles will be displayed in the main menu.
 - 2- Press “**P** ” or “**P** ” button to select a menu title, then press “” or “” button to enter the menu.
- To exit a menu, press “**STANDARD**” button.
 - To go to the previous menu, press “**MENU**” button.

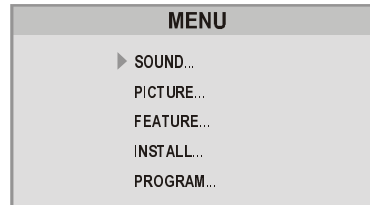

Sound Menu

To change sound settings:

- Press “**MENU**” button, now you are in main menu. In the main menu, **SOUND** will be the first selected option. Enter the sound menu pressing “” or “” button.

Setting Volume:

As you enter the sound menu, Volume will be the first selected option.

- Press “” button to increase volume.
- Press “” button to decrease volume.

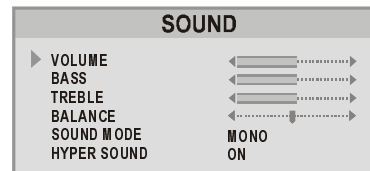

Setting Bass Level:

- Using “**P** ” or “**P** ” button select Bass.
- Press “” button to increase bass level.
- Press “” button to decrease bass level.

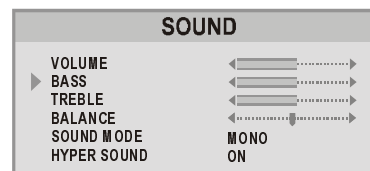

Setting Treble Level:

- Using “**P** ” or “**P** ” button select Treble.
- Press “” button to increase treble level.
- Press “” button to decrease treble level.

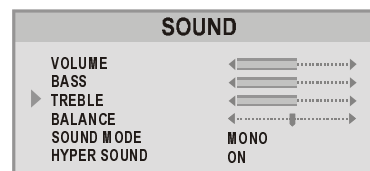

Setting Balance:

- Using "P ^" or "P v" button select Balance.
- Press "▶" button to change balance rightward.
- Press "◀" button to change balance leftward.

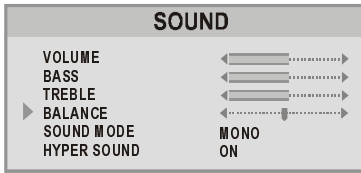

Selecting Sound Mode:

You can choose **MONO**, **STEREO** or **DUAL I-II** mode, only if the selected channel supports that mode.

- Using "P ^" or "P v" button select Sound Mode.
- Press "◀" or "▶" button to change Sound Mode.
- If the TV channel you are watching broadcasts in two languages (e.g. Eurosport), you can select the dubbed or the original language.
- When the stereo broadcast is received poorly, you can change from stereo to mono sound so that you can hear the broadcast more clearly and easily.

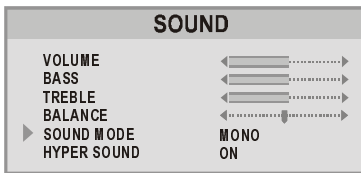

Hyper Sound:

You can use this feature to switch on or off Hyper Sound. Pressing "◀" or "▶" button will turn on or off this feature. If the current sound system is **MONO** and the Hyper Sound is set **ON**, then the sound will be heard as if it is **STEREO**. If the current sound system is **STEREO**, switching Hyper Sound on will make the sound deeper. Switching it off will make no change in **MONO** and **STEREO**.

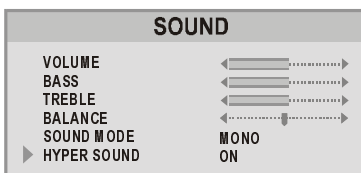

Hyper Sound can be set On or Off also by GREEN button.

Picture Menu

To change picture settings:

- Press "MENU" button, now you are in main menu. In the main menu, select **PICTURE** using "P ^" or "P v" button, then enter the picture menu pressing "◀" or "▶" button.

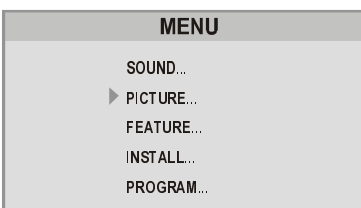

Note: When Picture Mode is not "**MANUAL**", **BRIGHTNESS**, **CONTRAST** and **COLOUR** options can not be reached by "P ^" or "P v" buttons.

Factory Settings:

In the Picture Menu if you press the **YELLOW** button the adjustments switches themselves to the factory settings.

Setting Brightness:

You can change **Brightness** only when Picture Mode is selected **MANUAL**.

Using "P ^" or "P v" button select Brightness.

- Press "▶" button to increase Brightness.
- Press "◀" button to decrease Brightness.

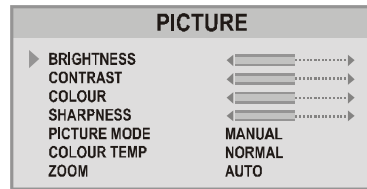

Setting Contrast:

You can change **Contrast** only when Picture Mode is selected **MANUAL**.

- Using "P ^" or "P v" button select Contrast.
- Press "▶" button to increase Contrast level.
- Press "◀" button to decrease Contrast level.

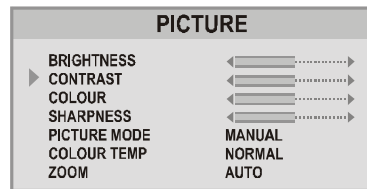

Setting Colour:

You can change **Colour** only when Picture Mode is selected **MANUAL**.

- Using "P ^" or "P v" button select Colour.
- Press "▶" button to increase Colour level.
- Press "◀" button to decrease Colour level.

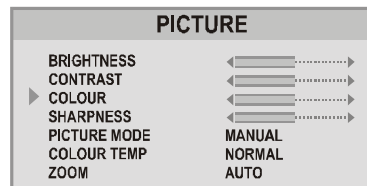

Setting Sharpness:

- Using "P ^" or "P v" button select Sharpness.
- Press "▶" button to increase Sharpness level.
- Press "◀" button to decrease Sharpness level.

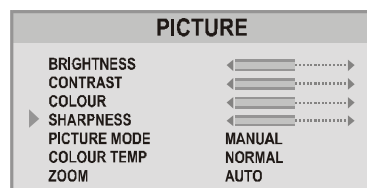

Setting Hue (In AV mode only) :

- Using "P ^" or "P v" button select Hue.
- Press "▶" button to increase Hue level.
- Press "◀" button to decrease Hue level.

Hue adjust is functional only when NTSC 3.58/4.43 is applied in AV mode. It does not appear when other colour systems used.

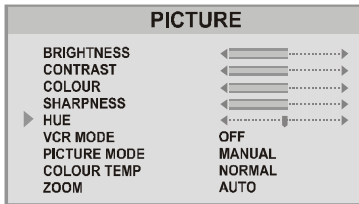

Setting VCR Mode (In AV mode only) :

- Using "P ^" or "P v" button select VCR MODE.
- When you watch a picture from your VCR and the picture is unstable, you may improve it by changing the "VCR MODE" setting from "ON" to "OFF".

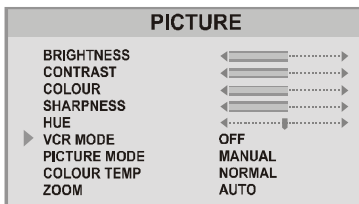

Picture Mode

This item is used to change the picture mode. By pressing "◀" or "▶" button you may choose one of these options: **BRIGHT, STANDARD, SOFT, MANUAL.**

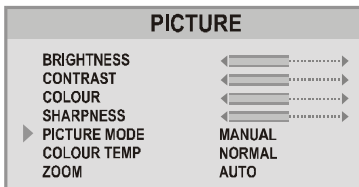

Colour Temp

This item is used to change the Colour Temperature. By pressing "◀" or "▶" button you may choose one of these options: **COOL, WARM, NORMAL.**

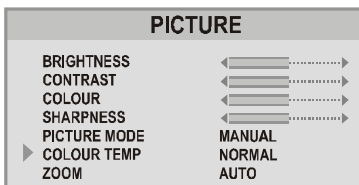

Zoom

This item is used to change the picture size. By pressing "◀" or "▶" button you may choose one of these options: **"AUTO", "4:3" and "16:9".**

- **4:3** This option forces the picture ratio to 4:3 mode.
- **16:9** This option forces the picture ratio to 16:9 mode.
- **AUTO** This allows to change the picture mode automatically, according to the transmission of the selected chan-

nel. For example, your TV is 4:3 mode, but the transmission of that channel is in 16:9 mode. If you select the AUTO mode, the TV is switched to 16:9 mode automatically. If the TV is in 4:3 mode and the picture ratio of the channel is also 4:3, there will be no affect selecting the picture mode to AUTO mode.

WSS feature is only used in TV and EXT-3 modes. For the Zoom selection in EXT-1 and EXT-2 the pin 8 (of Scart) value is used. In RGB mode the Zoom can be **"AUTO", "4:3" and "16:9"** mode.

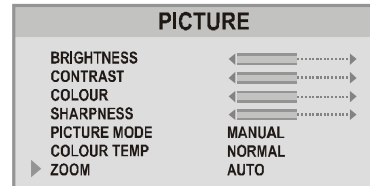

Zoom can be set to desired mode by RED button.

Feature Menu

- Press "MENU" button, now you are in main menu. In the main menu, select **FEATURE**, using "P ^" or "P v" button. Then enter the feature menu pressing "◀" or "▶" button.

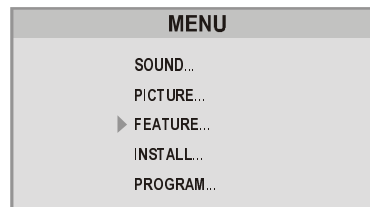

Sleep Timer

The sleep timer is used to turn the TV off after a defined period. Press "◀" or "▶" button to choose a period of time after selecting this item. The timer can be programmed between Off and 120 minutes in steps of 10 minutes. (**OFF, 010, 020, 030, 040, ,120.**)

If sleep timer is activated, at the end of the selected the time, the TV goes automatically to stand-by mode.

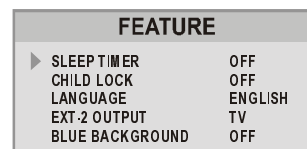

Child lock:

You can disable the control panel buttons (except the POWER button) with this item.

Press "◀" or "▶" button to change the setting to On or Off after selecting this item.

When you set this item to On, the TV can be operated only by using the remote control handset.

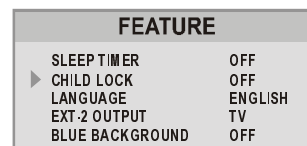

Warning: If Child Lock item is set to ON, the TV can not be operated by VCR.

Language:

Menu Language can be selected by pressing “◀” or “▶” button on **Language** item.

FEATURE	
SLEEP TIMER	OFF
CHILD LOCK	OFF
▶ LANGUAGE	ENGLISH
EXT-2 OUTPUT	TV
BLUE BACKGROUND	OFF

Setting External Source Output

- You can use this menu to select the internal or external source that will be output at **EXT.2** terminal.
- In the “**FEATURE**” menu select “**EXT-2 OUTPUT**” using “P ^” or “P v” button. Then select the source you want to be output at **EXT.2** pressing “◀” or “▶” button (one of the sources: **TV, EXT-1** or **EXT-3 (Front AV)**).

FEATURE	
SLEEP TIMER	OFF
CHILD LOCK	OFF
LANGUAGE	ENGLISH
▶ EXT-2 OUTPUT	TV
BLUE BACKGROUND	OFF

Blue Background During No-Signal

The **Blue Background** feature can be set by “◀” or “▶” button to either **ON** or **OFF**.

FEATURE	
SLEEP TIMER	OFF
CHILD LOCK	OFF
LANGUAGE	ENGLISH
EXT-2 OUTPUT	TV
▶ BLUE BACKGROUND	OFF

Install (Installation) Menu

You can store a channel manually, or modify the current settings of a channel (for example, fine-tuning a channel).

You can also changing the colour system, or change the **DECODER(EXT-2)** setting.

- Press “**MENU**” button to display the main menu.
- Press “P ^” or “P v” button to select “**INSTALL**” item. Then “◀” or “▶” button to display the “**INSTALL**” menu.

MENU	
SOUND...	
PICTURE...	
FEATURE...	
▶ INSTALL...	
PROGRAM...	

Note:

- If you want to modify the current settings of a channel, select the channel of which you want to modify the setting. Then display the main menu on screen.
- In AV mode, you can change only the “**COLOUR SYSTEM**” item.

INSTALL	
▶ PROGRAMME	P4
BAND	S
CHANNEL	6
STANDARD	BG
COLOUR SYSTEM	PAL
DECODER(EXT-2)	ON
FINE TUNING	◀.....▶
SEARCH	◀.....▶
STORE	

1. **PROGRAMME** will be the first selected item as you enter the **INSTALL** menu. Pressing “◀” or “▶” button select the programme number where you want to the tuned channel to be stored. (You may also type the programme number using the digit buttons)

Note:

- Do not use **PROGRAMME** item when you modify the current programme number's setting. If you select other programme number by mistake, the selected programme number's setting will be changed.
2. Press “P ^” or “P v” button to select **BAND**. Using “◀” or “▶” button to select the band in which you want to search a channel.
 3. Press “P ^” or “P v” button to select **SEARCH**. Press “◀” or “▶” button to start searching. (Press “▶” button to search forward. Press “▶” to search backwards.)
 - If the found channel is not the desired one, press “◀” or “▶” button to start searching again.
 - To stop searching before a channel is found, press the reverse direction button. For example, when the TV is searching forward with “▶” button, press “◀” button to stop searching.
 - If you know the channel number which you want to find, you can find the channel directly. Follow the step 4 to select the correct standard, then press “P ^” or “P v” to select **CHANNEL** again, and press “◀” or “▶” button to select the channel number, or enter the number with the digit buttons.
 4. If the sound or picture is abnormal, change the standard (broadcasting system) of new channel. Press “P ^” or “P v” button to select **STANDARD**, then press “◀” or “▶” button to change the correct one.
 - The indicated number will be changed when you change the standard.
- B/G : C02-C12, C21-C73 / S01-S41 / S75-S79**
D/K : 01-C12, C21-C69 / S01-S19, S22-S41
L : C01-C73 / S01-S41 / S75-S77
L' : C04-C09
5. If the picture is not clear or no colour appears, change the colour system to display the picture normally. Press “P ^” or “P v” button to select **COLOUR SYSTEM**, then press “◀” or “▶” button to choose the correct one.
 - In TV mode: **PAL / SECAM**
 - In AV mode: **AUTO / PAL / SECAM / NTSC 3.58 / NTSC 4.43**
 6. If the channel reception is poor, fine-tune the channel. Press “P ^” or “P v” to select **FINE TUNING**, then press “◀” or “▶” button to fine-tune the channel.
 7. After the all settings are completed, store the new channel's setting to the programme number which you selected. Press “P ^” or “P v” to select **STORE**, then press “◀” or “▶” button to store it. “**T-V LINK**” menu will appear after the TV stores the settings.

T-V LINK	
DOWNLOAD TV -> VCR	
▶ OK	
STANDARD : CANCEL	

- If you do not have a T-V LINK compatible VCR, press **"STANDARD"** button to exit the menu.

If you have a T-V LINK compatible VCR connected to the EXT.2 terminal, press **"i"** button to display **"T-V LINK"** menu. Then follow the operating procedure **"Downloading the data to VCR"** on **page 5** to transmit the Programme table data to the VCR.

To change the Colour system:

If the picture is not clear or no colour appears, choose the correct colour system to display the picture normally.

- Press **"P ^"** or **"P v"** button to select **COLOUR SYSTEM**, then press **"◀"** or **"▶"** button to choose the correct one.
 - In TV mode: **PAL / SECAM**
 - In AV mode: **AUTO / PAL / SECAM / NTSC 3.58 / NTSC 4.43**
- Press **"P ^"** or **"P v"** to select **STORE**, then press **"◀"** or **"▶"** button to store it.
- When **"T-V LINK"** menu appears, follow the step 4.

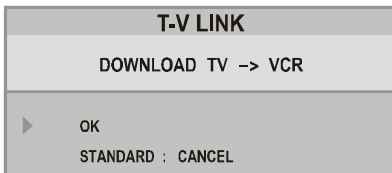

- If you do not have a T-V LINK compatible VCR, press **"STANDARD"** button to exit the menu.

If you have a T-V LINK compatible VCR connected to the EXT.2 terminal, follow the operating procedure **"Downloading the data to VCR"** on **page 5** to transmit the Programme table data to the VCR.

Decoder(EXT-2)

If you have a decoder connected to a T-V LINK compatible VCR, which in turn is connected to the EXT.2 terminal, use **DECODER(EXT-2)** to unscramble the scrambled TV channels.

- Exit the menu.
- Turn on the decoder power.
- Display the scrambled TV channel on the TV. Even if the decoder is working, a scrambled picture appears.
- Display the **"INSTALL"** menu again.
- Press **"P ^"** or **"P v"** button to select **DECODER(EXT-2)**, then press **"◀"** or **"▶"** button to set to **"ON"**
- Press **"P ^"** or **"P v"** to select **STORE**, then press **"◀"** or **"▶"** button to store it. **"T-V LINK"** menu will appear after the TV stores the setting.

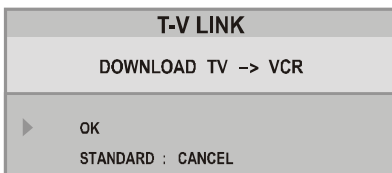

- Follow the operating procedure **"Downloading the data to VCR"** on **page 5** to transmit the revised programme table data to the VCR.

- If you do not want to transmit, press **"STANDARD"** button to exit the menu.

Note:

You can only use this item if you have a decoder connected to a **T-V LINK** compatible **VCR** to **EXT.2** terminal. Setting this item to **"ON"** by mistake causes the picture/sound of a TV channel you are currently viewing to disappear.

If this item has been set to **"ON"** but the TV channel cannot be unscrambled, check the following:

- Has the decoder been connected to the VCR properly according to the VCR and Decoder instruction manuals?
- Can the TV channel be unscrambled with a decoder?
- Do you need to change the VCR settings in order to connect the decoder? Confirm that the VCR is set properly by rechecking the VCR instruction manual.

Program (Programming) Menu

You can use the Program (Programming) menu to delete a channel, to change the programme number of a channel, to give a channel name to a channel, and to start the **AUTO PROGRAM (AUTOSTORE)** function.

- Press **"MENU"** button to display the main menu.
- Press **"P ^"** or **"P v"** button to select **"PROGRAM"** item, then **"◀"** or **"▶"** button to display the **"PROGRAM"** menu.

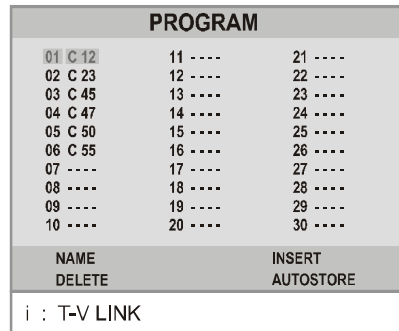

To choose a channel in the PROGRAM menu:

- Press **"P ^"** / **"P v"** / **"◀"** / **"▶"** button. The programme number that you choose is high-lighted in the **PROGRAM** menu and you can view the picture of that channel.

Caution:

Using **"DELETE"** or **"INSERT"** function rewrite the current channel list in the **PROGRAM** menu. Therefore, the programme numbers of some of channels will change.

When you complete the settings of PROGRAM menu:

If you have a T-V LINK compatible VCR, press the **"i"** button to display the T-V LINK menu. Then follow the operating procedure **"Downloading the data to VCR"** on **page 5** to transmit the Programme table data to the VCR.

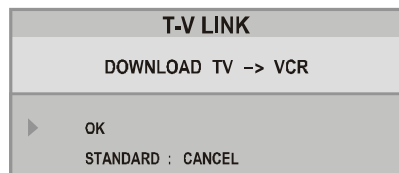

If you do not have a T-V LINK compatible VCR, press **"STANDARD"** button to exit the menu.

To give a channel name (NAME):

1. Choose the channel you want to give a channel name.
2. Press the RED button to enter the NAME mode.
3. Press “◀” or “▶” button to choose the position, and press “P^” or “P∨” button to choose each character of channel name.
4. Press the RED button to store the channel name.
 - To cancel the NAME mode, press the BLUE button.

To delete a channel (DELETE):

1. Choose the channel you want to delete.
2. Press the YELLOW button to enter the DELETE mode.
3. Press the YELLOW button to delete it.
 - To cancel this DELETE mode, press the BLUE button.

To change the programme number of a channel (INSERT):

1. Choose the channel you want to change the programme number.
2. Press the GREEN button to enter the INSERT mode.
3. Press “P^” / “P∨” / “◀” / “▶” button to choose new programme number.
4. Press the GREEN button to insert the channel to the chosen programme number.
 - To cancel this INSERT mode, press the BLUE button.

To start Auto Program (AUTOSTORE)

AUTO PROGRAM automatically programmes the received channels in your TV's programme numbers.

1. Press the **BLUE** button to enter the **AUTOSTORE** mode. A warning message appears.

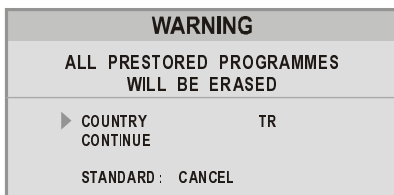

- To cancel the **AUTOSTORE** mode, press the “**STANDARD**” button.
2. Press “P^” or “P∨” button to choose the “**COUNTRY**”, then press “◀” or “▶” button the choose country you are now located.
 3. Press “P^” or “P∨” button to choose the “**CONTINUE**”, then press “▶” button to start **AUTO PROGRAM** The following message appears.

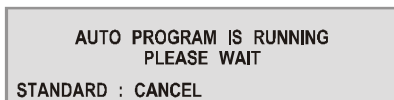

- To cancel the **AUTO PROGRAM**, press the “**STANDARD**” button.
4. After **AUTO PROGRAM** is finalized, the **PROGRAM** menu appears again.

Other Features

Sound Mute

To cut off the sound of the TV, press “M” button. The sound will be cut off. To cancel mute, press “M” or “▲” or “▼” button. The volume level will be the same as the level before mute when you cancel mute.

Information on Screen

First pressing the “i” button displays the current status “**Programme number**”, “**Station name**” and “**Sound status**”.

Pressing this button again displays the current time.

Pressing this button once more remove the on-screen display.

To Display the Time

- While watching a TV programme with Teletext transmission press “i” button twice. The current time information, captured from Teletext will be displayed at the upper left corner of the screen.
- If the programme being watched does not have Teletext transmission, no time information will be displayed.
- The time information will disappear after pressing “i” button again.

Picture Mode

You can change **Picture Mode** settings by pressing “**STANDARD**” button when no menu appears.

VCR Control Buttons

The buttons can be used to operate a JVC brand VCR. Pressing the button having the same appearance as the original remote control button of a device makes the function work in the same way as the original remote control.

Press the VCR Control Button to control your VCR.

Note:

- If your device is not made by JVC, these buttons cannot be used.
- Even if your device is made by JVC, some of these buttons or any one of the buttons may not work, depending on the device.
- You can use the ^ / ∨ buttons to choose a TV channel which the VCR will receive.

Teletext

Teletext is an information system that displays text on your TV screen. Using the Teletext information system you can view a page of information on a subject that is available in the list of contents (index).

No on screen display will be available in text mode.

No contrast, brightness or colour control, but volume control is available in text mode.

To operate Teletext

- Select a TV station on which Teletext is being transmitted.
- Press (teletext) "☰" button. Usually the list of contents (index) is displayed on the screen.

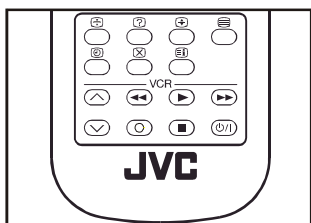

To select a page of Teletext

- Press the appropriate digit buttons for the required Teletext page number.

The selected page number is displayed at the top left corner of the screen. The Teletext page counter searches until the selected page number is located, so that the desired page is displayed on the screen.

- Press "P ^" button to move the Teletext screen forward one page at a time.
- Press "P v" button to move the Teletext screen backward one page at a time.

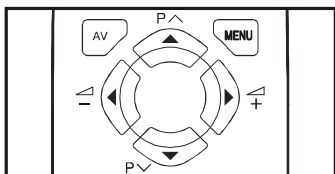

To Select Index Page

- To select the page number of the index (generally page 100), press "☰" button.

Searching for a teletext page while watching TV

- In the Teletext mode pressing "☒" button will switch the screen to the TV mode. In the TV mode enter a page number using digit buttons. As you enter last digit of page number, "☰" sign will replace the page number and flash until the entered page number is found. Then the page number will replace "☰" sign again. Now you can display this teletext page pressing "☒" button.

To Select Double Height Text

- Press "☰" button for the top half of the information page to be displayed in double height text.
- Press "☰" button again for the bottom half of the information page to be displayed in double height text.
- Press "☰" button once more for the full page of normal height text.

To Reveal "concealed" Information

- Pressing "?" button once will reveal answers on a quiz or games page.
- Pressing "?" button again will conceal the revealed answers.

To Stop Automatic Page Change

The teletext page you have selected may contain more information than what is on the screen; the rest of the information will be displayed after a period of time.

- Press "☒" button to stop the automatic page change.
- Press "☒" button again to allow the next page to be displayed.

To Select a Subcode Page

Subcode pages are subsections of long Teletext pages that can only be displayed on the screen one section at a time.

- Select the required Teletext page.
- Press "☰" button.
- Select the required subcode page number by pressing four digit buttons (e.g. 0001).
- If the selected subcode page is not displayed in a short time, press "☒" button. TV programme will be displayed on the screen.
- Teletext page number will be displayed on the upper left corner of the screen when the selected page is found.
- Press "☒" button to display the selected Teletext page.

To exit Teletext

- Press "☰" button. The screen will switch to TV mode.

Fastext and Toptext

Teletext mode will be selected according to transmission automatically.

Your CTV supports the 7 page Teletext system. When the page number of any of the 7 pages in memory is entered, the system will not search for the requested page; instead it will display the page automatically.

- Press "P ^" button to move the Teletext screen forward one page at a time.
- Press "P v" button to move the Teletext screen backward one page at a time.

For Fastext and Toptext

The subject-heading for the information may have a particular colour or can be in a form located in a coloured box.

- Press an appropriate **RED, GREEN, YELLOW** or **BLUE** button in order to reach the relevant page quickly.

For TOPTXT

If Toptext transmission is present, colour coded buttons will appear in status row.

If Toptext transmission is not present, status row will not appear.

In Toptext mode the "P ^" or "P v" commands will request the next or previous page respectively. If Toptext transmission is not available, in case of operation of these commands, wraparound occurs. For example page 100 appears to be one greater than page 199.

Connect the External Equipments

Via the Euroconnector

Your TV set has two Euroconnector sockets. If you want to connect equipments (e.g. video recorder, decoder, etc.) which have Euroconnectors, to your TV, use the **EXT.1 (EXT-1)** or **EXT.2 (EXT-2)** terminals.

If an external device is connected via Euroconnector sockets TV is switched to AV mode automatically.

T-V LINK compatible VCR

Be sure to connect the T-V LINK compatible VCR to the EXT-2 terminal. If not, the T-V LINK function will not work properly.

- When connecting a T-V LINK compatible VCR to the EXT-2 terminal, be sure to connect the decoder to the VCR. If not, the **T-V LINK** function may not work properly. And then set the **DECODER(EXT-2)** function for the channel to **ON** to unscramble a scrambled channel. For details, see "**Decoder(EXT-2)**" on **page 10**.

RGB mode

If an equipment can output the **RGB** signals, connect it to the **EXT.1 (EXT-1)** terminal.

EXT-2S Mode

If the equipment connected to your TV set supports S-Video (Y/C) output from Euroconnector, you can have a better picture quality by selecting **EXT-2S** mode and connecting your equipment to the **EXT.2 (EXT-2S)** terminal of TV. See your equipment's booklet to check if your equipment has such feature.

Via the RCA jacks

If you have an equipment (such as a Camcorder) which has the RCA jacks, connect it to the **Front AV (EXT-3)** terminal with the video and audio cables.

- If the equipment has the mono audio jack, connect it to the **AUDIO-L** jack.

Via the ANT (aerial) socket

If your equipment does not have an Euroconnector or RCA jacks, connect it to the TV with an aerial cable. For details, see the manual provided with the equipment.

- To store the test signal that comes from the equipment, see "**INSTALL Menu**" on **page 9** and store it to the programme number 0. You can watch images from that equipment to select the programme number which you stored the test signal.

TV and Video Recorder (VCR)

- Connect the Video Recorder to the ANT (antenna input) socket of the TV with the aerial cable.
- Connect the Video Recorder to the **EXT.1 (EXT-1)** or **EXT.2 (EXT-2)** terminal with the SCART cable, or connect it to the **Front AV (EXT-3)** terminal with the audio and video cables.

NTSC Playback

Connect a NTSC video recorder to a terminal. Then press "**AV**" button to select the corresponding AV mode.

NTSC 3.58/4.43 system is detected automatically in AV mode.

Copy Facility

You can output the video and audio signals which inputs from **TV** or **EXT.1 (EXT-1)** terminal to the video recorder connected to the **EXT.2 (EXT-2)** terminal.

- To select the output source, see "**Setting External Source Output**" on **page 9**.

Connecting Headphones

Use the stereo headphone socket of your TV, to connect headphones.

Connect the External Equipments

Before connecting anything

- Switch off all equipments including the TV.
- Read the manuals provided with the equipments.

To select an AV mode

Pressing "AV" button on the remote control selects one of AV modes (EXT-1, RGB, EXT-2, EXT-2S and EXT-3).

- To return to the TV mode, repeatedly press "AV" button.

EXT.1 (EXT-1) terminal: Euroconnector (21-pin, SCART)

- Video input, Audio L/R inputs and RGB inputs are available.
- TV broadcast outputs (Video and Audio L/R) are available.

EXT.2 (EXT-2) terminal: Euroconnector (21-pin, SCART)

- Video input, S-VIDEO (Y/C) input and Audio L/R inputs are available.
- Video and Audio L/R outputs are available. (See "Setting External Source Output" on page 9.)
- T-V LINK functions are available. (See "T-V LINK compatible VCR" on page 13.)

EXT.3 (EXT-3) (Front AV) terminal: RCA connectors x 3

- Video input and Audio L/R inputs are available.

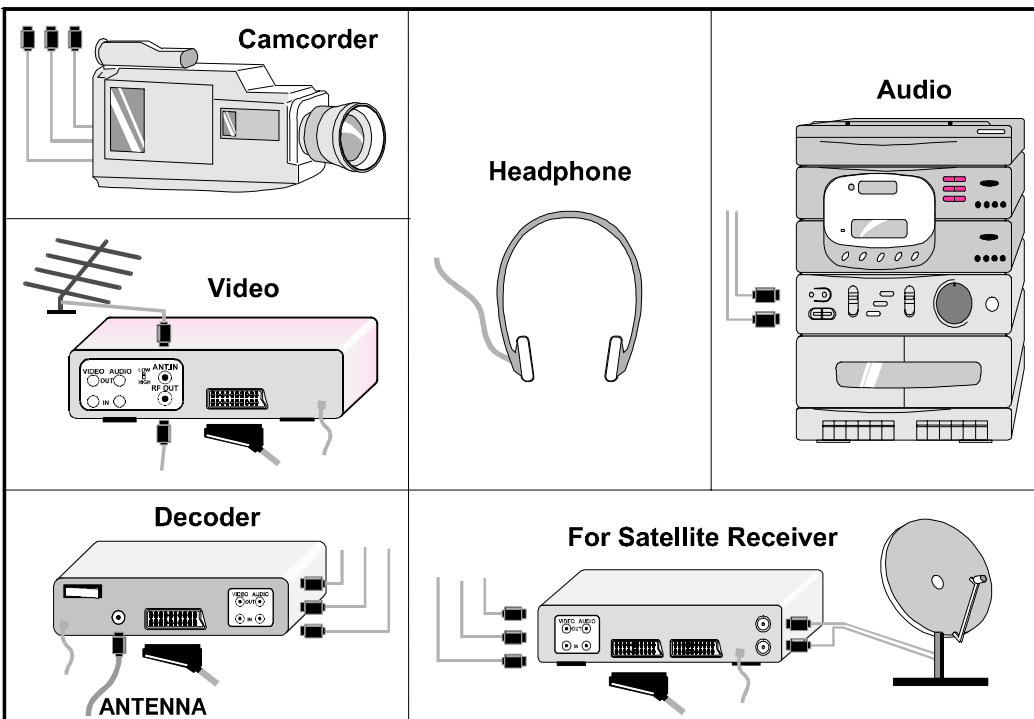
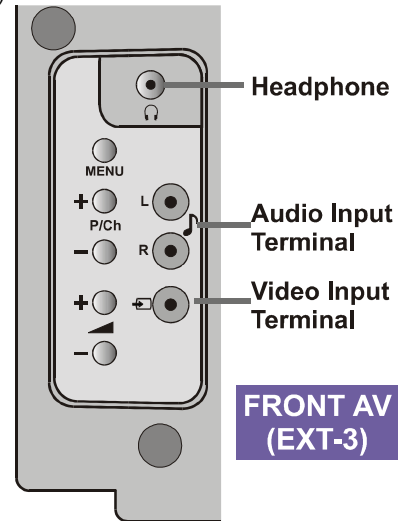
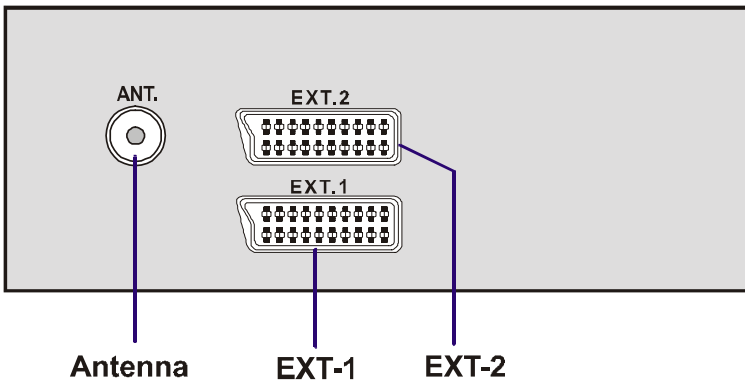

Tips

Care of the Screen

Clean the screen with a slightly damp, soft cloth. Do not use abrasive solvents as they may damage the TV screen coating layer.

Poor Picture

Have you selected the correct TV system? Is your TV set or house aerial located too close to the loudspeakers, non-earthed audio equipment or neon lights, etc. ?

Mountains or high buildings can cause double pictures or ghost images. Sometimes you can improve the picture quality by changing the direction of the aerial.

The picture quality may degrade when two peripherals are connected to the TV at the same time. In such a case, disconnect one of the peripherals.

No Picture

Is the aerial connected properly? Are the plugs connected tightly to the aerial socket? Is the aerial cable damaged? Are suitable plugs used to connect the aerial? If you are in doubt, consult your dealer.

No Picture means that your TV is not receiving any transmission. Have you pressed the correct keys on the remote control? Try once more.

Sound

Sound is coming from only one of the speakers. Is the balance set to one direction extreme? See **SOUND** menu.

Remote Control

Your TV no longer responds to the remote control. Perhaps the batteries are exhausted. If so you can still use the local buttons at the right side of your TV.

Have you selected the wrong menu? Press "**STANDARD**" button to return to TV mode or press "**MENU**" button to return to the previous menu.

No solution

Switch your TV set off and on. If this does not work, call the service personnel; never attempt to repair it yourself.

Specifications

TV BROADCASTING

PAL SECAM B/G D/K L/L'

RECEIVING CHANNELS

VHF (BAND I/III)

UHF (BAND U)

HYPERBAND

CABLE-TV (**B/G**: S01-S41 / S75-S79

D/K: S01-S19, S22-S41

L: S01-S41 / S75-S77)

NUMBER OF PRESET CHANNELS

100

CHANNEL INDICATOR

ON SCREEN DISPLAY

RF AERIAL INPUT

75 Ohm Unbalanced

OPERATING VOLTAGE

220-240V AC, 50 Hz.

SOUND-MULTIPLEX SYSTEMS

German + Nicam Stereo

PICTURE TUBE

28" 4:3

AUDIO OUTPUT POWER (W_{RMS}) (%10 THD)

2 x 10

POWER CONSUMPTION (W) (max)

120 Watt

DIMENSIONS (WxHxD) (mm)

DIMENSIONS			
W	H	D	Weight (kg)
760	570	473	33