



JVC

ENGLISH

AV-28F3SJ

JVC

COLOUR TELEVISION

INSTRUCTIONS



50056683

1004-MKH-VT-VT



Contents

Safety Precautions	1
Warning	2
Guidelines for safe operation	2
Remote Control Buttons	3
Control Panel Buttons	4
Antenna Connections	4
Preparation	5
Features	5
Before Switching on your TV	5
Power connection	5
Aerial Connections	5
How to connect the external equipments	5
Inserting batteries in the remote control handset	5
Switching the TV ON/OFF	5
To switch the TV on	5
To switch the TV off	5
Initial Settings	5
T-V LINK	6
Operating with the onset buttons	7
Operating with Remote Control	7
Menu System	7
Sound Menu	7
Picture Menu	8
Feature Menu	10
Install (Installation) Menu	10
Using the Decoder (EXT-2) function	11
Program (Programming) Menu	12
To start AUTO PROGRAM (AUTOSTORE)	12
Other Features	12
Sound Mute	12
Stereo / Bilingual	12
Information on Screen	12
To Display the Time	13
Picture	13
VCR / DVD Control Buttons and VCR /  / DVD Switch	13
Teletext	13
To operate Teletext	13
To select a page of Teletext	13
To Select Index Page	13
Searching for a teletext page while watching TV	13
To Select Double Height Text	13
To Reveal "concealed" Information	14
To Stop Automatic Page Change	14
To Select a Subcode Page	14
To exit Teletext	14
Fastext and Topext	14
Connect the External Equipments	14
Via the Euroconnector	14
T-V LINK compatible VCR	14
RGB mode	14
EXT-2S Mode	14
Via the RCA jacks	14
Via the ANT (aerial) socket	14
TV and Video Recoder (VCR)	14
NTSC Playback	16
Copy Facility	16
Connecting Headphones	16
Tips	16
Specifications	16

Safety Precautions

1. Power Source

The receiver should be operated only from a **220-240V AC, 50 Hz.** outlet. Ensure you select the correct voltage setting for your convenience.

2. Power Cord

The power supply cord should be placed so that they are not likely to be walked on or pinched by items placed upon them or against them. Pay particular attention to cord where they enter the plug, power outlet, and the point where they exit from the receiver.

3. Moisture and Water

Do not use this equipment in a humid and damp place (avoid the bathroom, the sink in the kitchen, and near the washing machine). Do not expose this equipment to rain or water and do not place objects filled with liquids on it as this may be dangerous.

4. Cleaning

Before cleaning, unplug the receiver from the main supply outlet. Do not use liquid or aerosol cleaners. Use with soft and dry cloth.

5. Ventilation

The slots and openings on the receiver are intended for ventilation and to ensure reliable operation. To prevent overheating, these openings must not be blocked or covered in any way.

6. Lightning

In case of storm and lightning or when going on holiday, disconnect the power cord from the wall outlet.

7. Replacement Part

When replacement parts are required, be sure the service technician has used replacement parts which are specified by the manufacturer or have the same specifications as the original one. Unauthorized substitutions may result in fire, electrical shock, or other hazards.

8. Servicing

Please refer all servicing to qualified personnel. Do not remove cover as this may result in electric shock.

9. Flame sources

Do not place naked flame sources on the apparatus.

10. Stand-By

Do not leave your TV stand-by or operating condition when you leave your house.

Warning!

Any intervention contrary to regulations, in particular, any modification of high voltage or a replacement of the picture tube may lead to an increased concentration of x-rays. Any television modified in this way no longer complies with license and must not be operated.

Instructions for waste disposal:

Packaging and packaging aids are recyclable and should principally be recycled. Packaging materials, such as foil bag, must be kept away from children.

Batteries, including those which are heavy metal-free, should not be disposed of with household waste. Please dispose of used batteries in an environmentally sound manner. Find out about the legal regulations which apply in your area.

Warning

DO NOT cut off the mains plug from this equipment.

If the plug fitted is not suitable for the power points in your home or the cable is too short to reach a power point, then obtain an appropriate safety approved extension lead or adaptor or consult your dealer.

If nonetheless the mains plug is cut off, remove the fuse and dispose of the plug immediately, to avoid a possible shock hazard by inadvertent connection to the mains supply.

If a new mains plug has to be fitted, then follow the instruction given below:

Important

Do not make any connection to the larger terminal which is marked with the letter E or by the safety earth symbol “ \perp ” or coloured green or green-and-yellow.

The wires in the mains lead on this product are coloured in accordance with the following code:

Blue: Neutral

Brown: Live

As these colours may not correspond with the coloured marking identifying the terminals in your plug proceed as follows:

The wire which is coloured blue must be connected to the terminal which is marked with the letter N or coloured black.

The wire which is coloured brown must be connected to the terminal which is marked with the letter L or coloured red.

When replacing the fuse only a correctly rated approved type should be used and be sure to re-fit the fuse cover.

If in doubt — consult a competent electrician.

How to replace the fuse

Open the fuse compartment with a blade screwdriver, and replace the fuse.

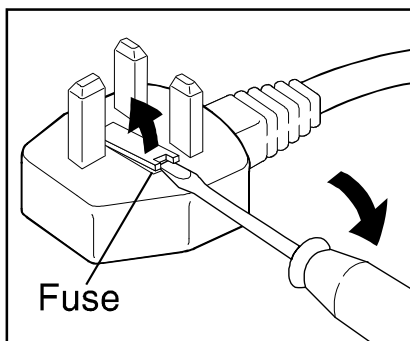
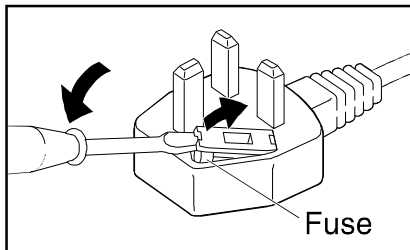

Guidelines for safe operation

This equipment has been designed and manufactured to comply with international safety standards.

However, as with any electrical appliance, care must be taken to ensure optimal results and operational safety.

- Before attempting to use this equipment, read the operating instructions thoroughly.
- Ensure that all electrical connections (including the mains plug, extension leads, etc.) have been made in accordance with the manufacturer's instructions.
- If ever in doubt about the installation, operation or safety of this equipment, consult your dealer.
- Handle all glass panels or covers with care.
- Never operate this equipment if it appears damaged or operates abnormally. Turn the power off, disconnect the main power plug and consult your dealer.
- Never remove any affixed panels or covers. Doing so may result in electrical shock.
- Never leave this equipment operating unattended unless otherwise specifically stated that it is designed to do so or in standby mode. Only use the designated power switch to turn off the power and ensure that all potential users are instructed how to do so. Make special arrangements for infirm or handicapped persons.
- Never listen to headphones at high volume. Doing so may damage your hearing.
- Never obstruct the ventilation of this equipment. Doing so may cause overheating and result in a malfunction or damage.
- Never use makeshift stands or attempt to affix legs with wood screws. When using a manufacturer's approved stand or legs, use only the fixtures provided and follow the installation instructions.
- Never allow this equipment to be exposed to rain or moisture.
- Never allow anyone, especially children, to insert anything into an opening in the case. Doing so may result in a fatal electrical shock.
- Never guess or take chances with electrical equipment of any kind. It is better to be safe than sorry.

Remote Control Buttons

- ① = Stand By / Power
- ② **0 - 9** = Direct Program
- ③ Yellow Button / Factory Settings in Picture Menu
- ④ Blue Button
- ⑤ **PICTURE** = Picture Mode Change
- ⑥ (P^) = Programme Up (Cursor Up)
- ⑦ **MENU** = Menu Button
- ⑧ (P-) = Cursor Right / Volume +
- ⑨ (P^v) = Programme Down (Cursor Down)
- ⑩ Teletext / VCR /DVD Control Buttons
- ⑪ = Stereo / Bilingual Button
- ⑫ = VCR / / DVD Switch
- ⑬ = Information Button / T-V Link in Program Menu
- ⑭ (P<) = Cursor Left / Volume -
- ⑮ **AV** = AV Button
- ⑯ = Teletext Button
- ⑰ **ZOOM** = Zoom (Picture Size) Change / Red Button
- ⑱ = Hyper Sound / Green Button
- ⑲ = Mute

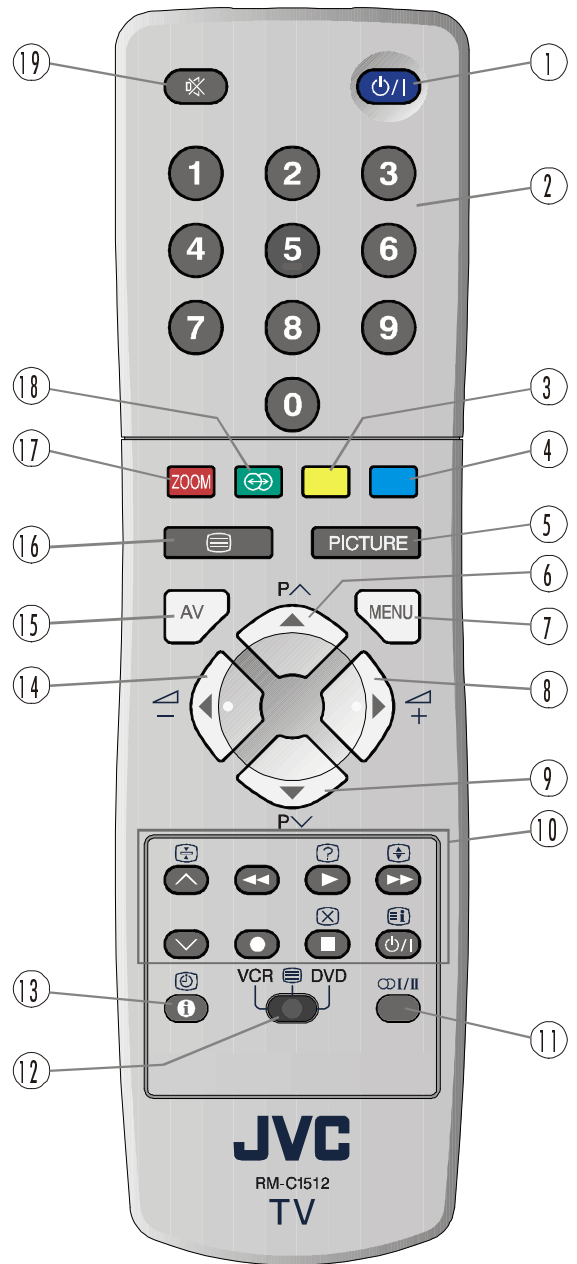

CAUTION
RISK OF ELECTRIC SHOCK



The lightning flash with arrowhead symbol, within an equilateral triangle, is intended to alert the user to the presence of uninsulated "dangerous voltage" within the product's enclosure that may be of sufficient magnitude to constitute a risk of electric shock of persons.

The exclamation point within an equilateral triangle is intended to alert the user to the presence of important operating and maintenance (servicing) instructions in the literature accompanying the appliance.

Control Panel Buttons

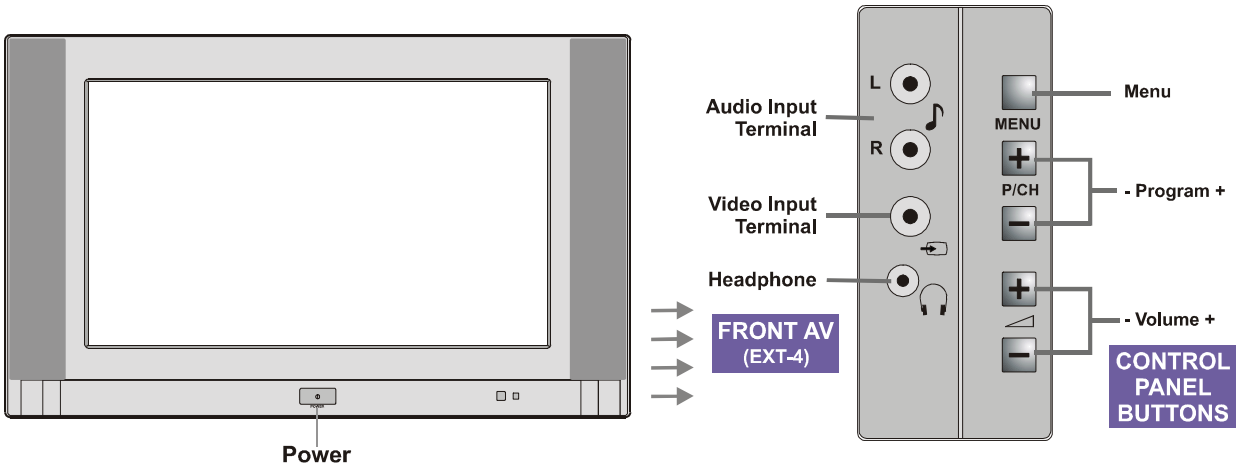

Antenna Connections

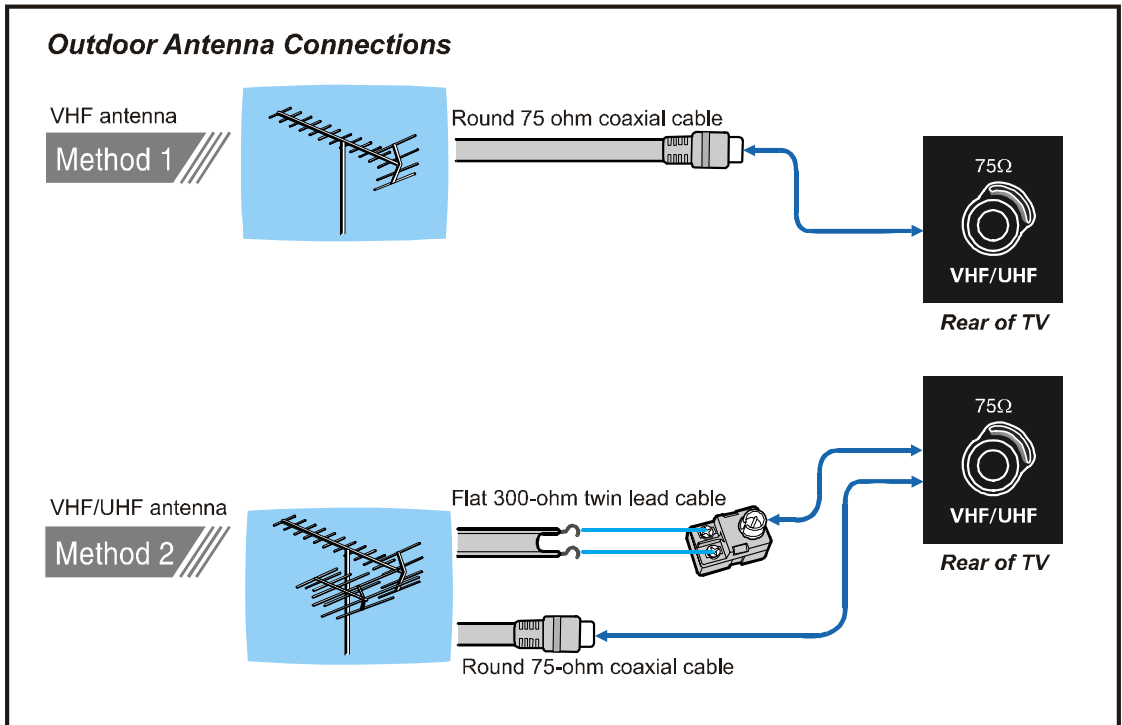

Preparation

Place TV on a solid surface.

For ventilation, leave a space of at least 10 cm free all around the set. To prevent any fault and unsafe situations, please do not place any objects on top of the set.

“Use this apparatus in tropical and moderate climates.”

Features

- It is a remote controlled colour television.
- 100 programmes from VHF, UHF bands or cable channels can be preset.
- It can tune cable channels.
- Controlling the TV is very easy by its menu driven system.
- It has three Euroconnector sockets for external devices (such as video recorder, video games, audio set, etc.)
- Front AV (EXT-4) Input available.
- Stereo sound systems (Nicom) are available.
- Full function Teletext (Fastext, Toptext).
- It is possible to connect headphone.
- Direct channel access.
- AUTO PROGRAM (Automatic Programming System).
- All programmes can be named.
- Forward or backward automatic tuning.
- Sleep timer.
- Child Lock.
- Blue Background.
- Panoramic Mode.
- Comb Filter : Digital circuitry to make adjustments providing outstanding picture quality with sharp, crisp edges, while virtually eliminating dot crawl.
- CTI : (Colour Transient Improvement) Improvement of horizontal transitions of chrominance (colour) signals.
- T-V Link.
- Automatic sound mute when no transmission.
- When no valid signal is detected, after 5 minutes the TV switches itself automatically to stand-by mode.
- WSS (Wide Screen Signaling).
- NTSC Playback.

Before Switching on your TV

Power connection

Important: The TV set is designed to operate on **220-240 V AC, 50 Hz.**

- After unpacking, allow the TV set to reach the ambient room temperature before you connect the set to the mains.

Aerial Connections

- Connect the aerial plug to the aerial input socket located at the back of the TV.

How to connect the external equipments

See “**Connect the External Equipments**” on **page 15.**

- See the instruction manuals provided with the external devices too.

Inserting batteries in the remote control handset

- Remove the battery cover located on the back of the handset by gently pulling upwards from the indicated part.
- Insert two **AA (R6)** or equivalent type batteries inside.

- Replace the battery cover.

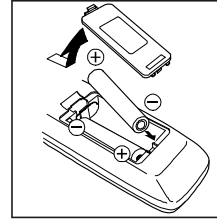

NOTE: Remove batteries from remote control handset when it is not to be used for a long period. Otherwise it can be damaged due to any leakage of batteries.

Switching the TV ON/OFF

You can operate your TV either using the remote control handset or directly using the TV onset buttons.

To switch the TV on

Your TV will switch on in two steps:

- 1- Press the power button located on the front of the TV. Then the TV switches itself to standby mode and the **RED LED** located below the TV turns on.

- 2- To switch on the TV from stand-by mode either:

Press a digit button on the remote control so that a programme number is selected,

or,

Press Standby / Power Button or Programme Up and Down buttons on the TV or on the remote control respectively, so the TV will switch on and the **RED** Led will turn **GREEN.**

To switch the TV off

- Press the stand-by button on the remote control, so the TV will switch to stand-by mode and the **GREEN LED** will become **RED,** or,
- Press the power button located on the front of the TV.

Initial Settings

The message “**PLEASE CHECK ANTENNA CABLE AUTO. PROGRAMMING SYSTEM**” will be displayed when you turn on your TV for the first time.

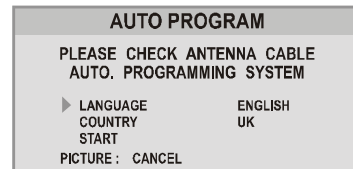

- 1- Select **LANGUAGE** with “**P ^**” or “**P v**” button, then press the “**◀**” or “**▶**” button to select a menu language.

- 2- Select **COUNTRY** with “**P ^**” or “**P v**” button, then press the “**◀**” or “**▶**” button to select the country you are now located.

- 3- Select **START** with “**P ^**” or “**P v**” button, then press the “right” button to start **AUTO PROGRAM.**

AUTO PROGRAM, (Automatic Programming System) automatically programmes the received channels in your TV's programme numbers. During **AUTO PROGRAM,** “**AUTO PROGRAM IS RUNNING PLEASE WAIT**” will be displayed. After **AUTO PROGRAM** is finalized, the “**PROGRAM**” menu appears.

To cancel **AUTO PROGRAM**, press the **"PICTURE"** button.

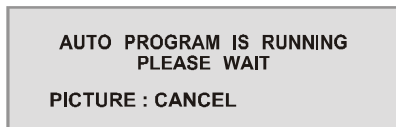

PROGRAM		
01 C 12	11 ----	21 ----
02 C 23	12 ----	22 ----
03 C 45	13 ----	23 ----
04 C 47	14 ----	24 ----
05 C 50	15 ----	25 ----
06 C 55	16 ----	26 ----
07 ----	17 ----	27 ----
08 ----	18 ----	28 ----
09 ----	19 ----	29 ----
10 ----	20 ----	30 ----
NAME	INSERT	
DELETE	AUTOSTORE	
i : T-V LINK		

You can delete a channel, insert a channel into a programme number, or re-start **AUTO PROGRAM** with the **"PROGRAM"** menu. For details, see **"PROGRAM (Programming) menu"** on **page 11**.

4- If you do not have a T-V LINK compatible VCR, press **"PICTURE"** button to exit the menu.

If you have a T-V LINK compatible VCR connected to the **EXT.2** terminal, press **"(i)"** button to display **"T-V LINK"** menu. Then follow the operating procedure **"Downloading data to VCR"** in the following **"T-V LINK"** section.

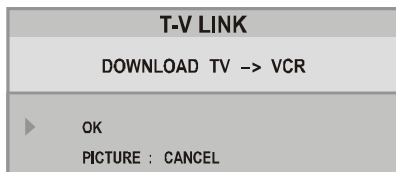

If the message **"PLEASE CHECK ANTENNA CABLE AUTO. PROGRAMMING SYSTEM"** does not appear, or if you want to modify the settings later, you can do manually with the **"FEATURE"**, **"INSTALL"** and **"PROGRAM"** menus.

For users in the UK:

If you have any problems setting up your new TV, please call the **JVC Helpline** on **0870 330 5000**.

For users in the Republic of Ireland:

If you have any problems setting up your new TV, please contact your local **JVC** dealer.

T-V LINK

When a T-V LINK compatible VCR is connected to the **EXT.2** Terminal on the TV, it is easier to set up the VCR and to view videos. T-V LINK uses the following features:

To use T-V LINK functions:

A **"T-V LINK compatible VCR"** means a JVC video cassette recorder with the T-V LINK logo, or with one of the following logos. However, these VCRs may support some or all of the features described earlier. For details, see your VCR instruction manual.

- "Q-LINK"** (a trademark of Panasonic Corporation)
- "Data Logic"** (a trademark of Metz Corporation)
- "Easy Link"** (a trademark of Phillips Corporation)

- "Megalogic"** (a trademark of Grundig Corporation)
- "SMARTLINK"** (a trademark of Sony Corporation)

Downloading data to VCR:

The VCR will automatically download the registered data on the TV channels from the TV. This means you do not need to set up the programme channels on your VCR manually.

The **"T-V LINK"** menu will be displayed when you press the **"(i)"** button while **"PROGRAM"** menu is displayed, or whenever the **"INSTALL"** menu operations are performed.

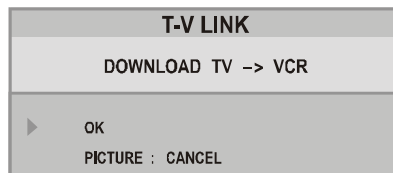

Press **"▶"** button to start downloading data to VCR.

- If you do not want to do, press the **"PICTURE"** button to exit the menu.



When **"FEATURE NOT AVAILABLE..."** is displayed:

If **"FEATURE NOT AVAILABLE..."** is displayed, the download was not performed correctly. Before trying to download again, check that:

- The VCR power is turned on
- The VCR is T-V LINK compatible
- The VCR is connected to the **EXT.2** terminal
- The SCART cable is fully wired.

Direct Rec:

"What You See Is What You Record"

You can easy record to VCR the images that you are watching on the TV. For details, read the manual for your VCR, Use your VCR controls. You cannot carryout Direct Rec using your TV's control.

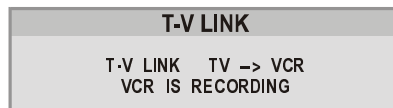

When the VCR is not ready (for example when there is no tape inserted), **"NO RECORDING"** is displayed.

In the following situations, the VCR will stop recording if the TV is turned off, if the TV channel or input is changed, or if the menu is displayed on the TV:

- When recording images from an external device connected to the TV. (For example a camcorder)
- When recording a TV channel after it has been unscrambled on a decoder.
- When recording a TV channel by using the TV's output because the VCR's own tuner cannot properly receive that channel.

TV auto power on/VCR image view:

When the VCR starts playing, the TV automatically turns on and the images from **EXT.2 (EXT-2)** terminal appear on the screen.

This function does not happen if your TV's main power is turned off. Set your TV's main power to on (standby mode).

Operating with the onset buttons

Volume setting and programme selection can be made using the buttons on the right side of the TV.

Volume Setting:

- Press “▲-” button to decrease volume or “▲+” button to increase volume, so a volume level scale will be displayed on the screen.

Programme Selecting:

- Press “P/Ch+” button to select next programme or “P/Ch-” button to select the previous programme.

Entering Main Menu:

- Press “MENU” button to enter main menu. In the main menu select submenu using “P/Ch+” or “P/Ch-” button and enter the submenu using “▲+” or “▲-” button. To learn the usage of the menus, refer to “Menu System” on page 7.

Operating with Remote Control

The remote control handset of your TV is designed to control all the functions of the model you selected. The functions will be described in accordance with the menu system of your TV.

Functions which you can use out of menu system are described below.

Volume Setting:

Press “▲+” button to increase volume.

Press “▲-” button to decrease volume.

Programme Selecting (Previous or next programme):

- Press “P ∨” button to select the previous programme.
- Press “P ∧” button to select the next programme.

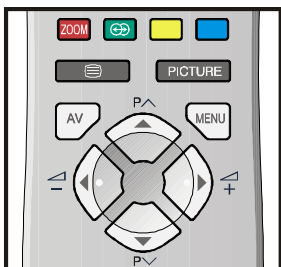

Programme Selecting (direct access):

Press digit buttons on the remote control handset to select programmes between 0 and 9. TV will switch to the selected program after a short delay.

- For a two digit program number enter the second digit after pressing the first digit within 2 seconds.

Menu System

Your TV has been designed with a menu system. Display “MENU” (main menu) and enter one of five menus (SOUND, PICTURE, FEATURE, INSTALL and PROGRAM).

- 1- Press “MENU” button to display “MENU” (main menu). The menu titles will be displayed in the main menu.
- 2- Press “P ∧” or “P ∨” button to select a menu title, then press “◀” or “▶” button to enter the menu.
 - To exit a menu, press “PICTURE” button.
 - To go to the previous menu, press “MENU” button.

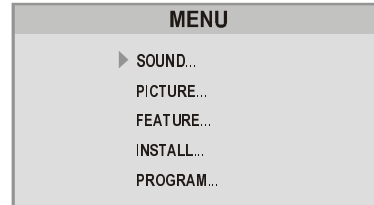

Sound Menu

To change sound settings:

- Press “MENU” button, now you are in main menu. In the main menu, SOUND will be the first selected option. Enter the sound menu pressing “◀” or “▶” button.

Setting Volume:

As you enter the sound menu, Volume will be the first selected option.

- Press “▶” button to increase volume.
- Press “◀” button to decrease volume.

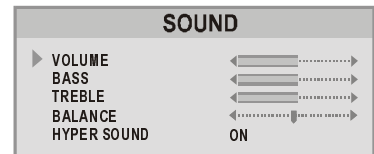

Setting Bass Level:

- Using “P ∧” or “P ∨” button select Bass.
- Press “▶” button to increase bass level.
- Press “◀” button to decrease bass level.

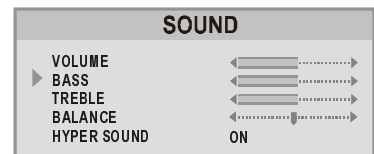

Setting Treble Level:

- Using “P ∧” or “P ∨” button select Treble.
- Press “▶” button to increase treble level.
- Press “◀” button to decrease treble level.

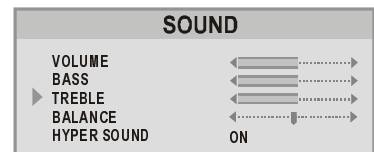

Setting Balance:

- Using “P ^” or “P v” button select Balance.
- Press “▶” button to change balance rightward.
- Press “◀” button to change balance leftward.

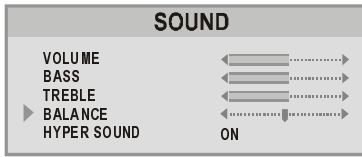

Hyper Sound:

You can use this feature to switch on or off Hyper Sound. Pressing “◀” or “▶” button will turn on or off this feature. If the current sound system is **MONO** and the Hyper Sound is set **ON**, then the sound will be heard as if it is **STEREO**. If the current sound system is **STEREO**, switching Hyper Sound on will make the sound deeper. Switching it off will make no change in **MONO** and **STEREO**.

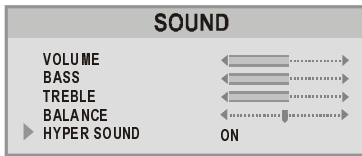

Hyper Sound can be set On or Off also by GREEN button.

Picture Menu

To change picture settings:

- Press “MENU” button, now you are in main menu. In the main menu, select **PICTURE** using “P ^” or “P v” button, then enter the picture menu pressing “◀” or “▶” button.

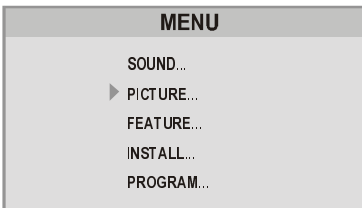

Note: When Picture Mode is not “**MANUAL**”, BRIGHTNESS, CONTRAST and COLOUR options can not be reached by “P ^” or “P v” buttons.

Factory Settings:

In the Picture Menu if you press the **YELLOW** button the adjustments switches themselves to the factory settings.

Setting Brightness:

You can change **Brightness** only when Picture Mode is selected **MANUAL**.

Using “P ^” or “P v” button select Brightness.

- Press “▶” button to increase Brightness.
- Press “◀” button to decrease Brightness.

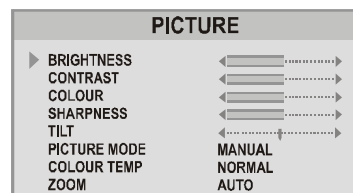

Setting Contrast:

You can change **Contrast** only when Picture Mode is selected **MANUAL**.

- Using “P ^” or “P v” button select Contrast.
- Press “▶” button to increase Contrast level.
- Press “◀” button to decrease Contrast level.

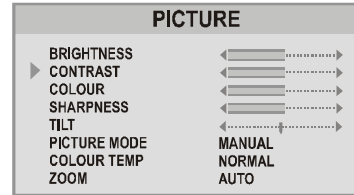

Setting Colour:

You can change **Colour** only when Picture Mode is selected **MANUAL**.

- Using “P ^” or “P v” button select Colour.
- Press “▶” button to increase Colour level.
- Press “◀” button to decrease Colour level.

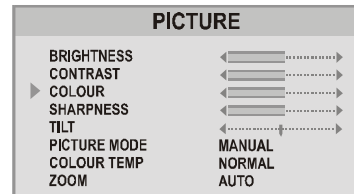

Setting Sharpness:

- Using “P ^” or “P v” button select Sharpness.
- Press “▶” button to increase Sharpness level.
- Press “◀” button to decrease Sharpness level.

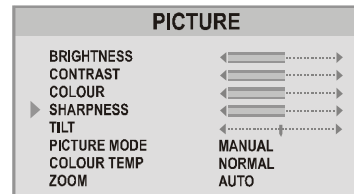

Setting Tilt:

- Using “P ^” or “P v” button select Tilt.
- Press “▶” button to increase tilt level.
- Press “◀” button to decrease tilt level.

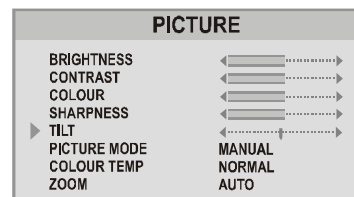

Setting Hue (In AV mode only) :

- Using “P ^” or “P v” button select Hue.
- Press “▶” button to increase Hue level.
- Press “◀” button to decrease Hue level.

Hue adjust is functional only when NTSC 3.58/4.43 is applied in AV mode. It does not appear when other colour systems used.

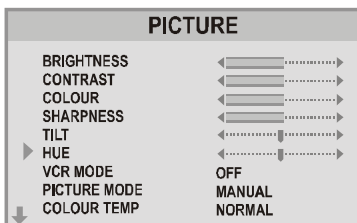

Setting VCR Mode (In AV mode only) :

- Using "P ^" or "P v" button select VCR MODE.
- When you watch a picture from your VCR and the picture is unstable, you may improve it by changing the "VCR MODE" setting from "ON" to "OFF".

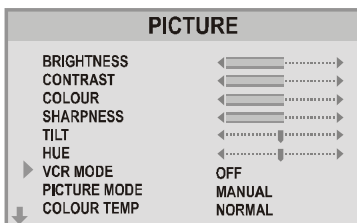

Picture Mode:

This item is used to change the picture mode. By pressing "◀" or "▶" button you may choose one of these options: **BRIGHT, STANDARD, SOFT, MANUAL.**

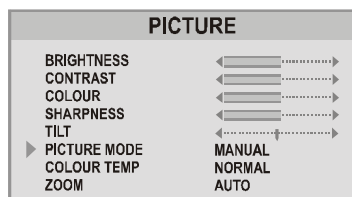

Colour Temp:

This item is used to change the Colour Temperature. By pressing "◀" or "▶" button you may choose one of these options: **COOL, WARM, NORMAL.**

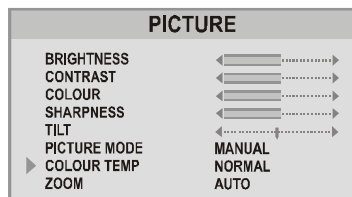

Zoom:

You can change the screen size according to the picture aspect ratio. Choose the optimum one from the following **ZOOM** modes.

AUTO:

When a **WSS (Wide Screen Signalling)** signal, which shows the aspect ratio of the picture, is included in the broadcast signal or the signal from an external device, the TV automatically changes the **ZOOM** mode to **16:9 ZOOM** mode or **FULL** mode according to the **WSS** signal.

If a **WSS** signal is not included, the picture is displayed in the **PANORAMIC** mode.

- When the **AUTO** mode does not function correctly due to poor **WSS** signal quality or when you want to change the **ZOOM** mode, change to another **ZOOM** mode manually.

REGULAR:

Use to view a normal picture (4:3 aspect ratio) as this is its original shape.



PANORAMIC:

This stretches the left and right sides of a normal picture (4:3 aspect ratio) to fill the screen, without making the picture appear unnatural.



- The top and bottom of the picture are slightly cut off.

14:9 ZOOM:

This zooms up the wide picture (14:9 aspect ratio) to the upper and lower limits of the screen.



16:9 ZOOM:

This zooms up the wide picture (16:9 aspect ratio) to the full screen.



16:9 ZOOM S:

This zooms up the wide picture (16:9 aspect ratio) with subtitles to the full screen.



FULL:

This uniformly stretches the left and right sides of a normal picture (4:3 aspect ratio) to fill the wide TV screen.



- For 16:9 aspect ratio pictures that have been squeezed into a normal picture (4:3 aspect ratio), use the **FULL** mode to restore the picture to its original shape.

Choose the ZOOM mode:

Press the "◀" or "▶" button to choose a **ZOOM** mode.

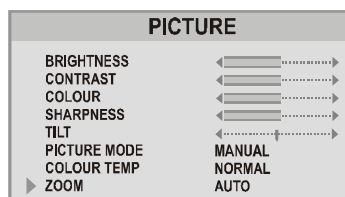

- You can choose the **ZOOM** mode by pressing the “**ZOOM**” (**RED**) button when no menu appears on the screen.
- The **ZOOM** mode may be automatically changed by the control signal from an external device. When you want to return the previous **ZOOM** mode, choose the **ZOOM** mode again.

Adjusting the visible area of the picture:

If subtitles or the top (or bottom) of the picture are cut off, you can adjust the visible area of the picture manually.

- Press “**ZOOM**” button once.

The **ZOOM** mode indicator appears. The **ZOOM** mode will not be changed.

- While it is displayed, press “**P** ^” or “**P** v” to change the position of the picture.

- You cannot adjust the visible area in **REGULAR** or **FULL** mode.



Feature Menu

- Press “**MENU**” button, now you are in main menu. In the main menu, select **FEATURE**, using “**P** ^” or “**P** v” button. Then enter the feature menu pressing “◀” or “▶” button.

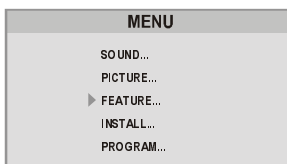

Sleep Timer:

The sleep timer is used to turn the TV off after a defined period. Press “◀” or “▶” button to choose a period of time after selecting this item. The timer can be programmed between Off and 120 minutes in steps of 10 minutes. (**OFF, 010, 020, 030, 040, ,120.**)

If sleep timer is activated, at the end of the selected the time, the TV goes automatically to stand-by mode.

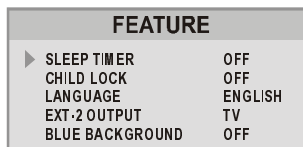

Child lock:

You can disable the control panel buttons (except the POWER button) with this item.

Press “◀” or “▶” button to change the setting to On or Off after selecting this item.

When you set this item to On, the TV can be operated only by using the remote control handset.

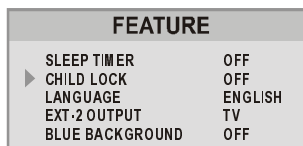

Warning: If Child Lock item is set to ON, the TV can not be operated by VCR.

Language:

Menu Language can be selected by pressing “◀” or “▶” button on **Language** item.

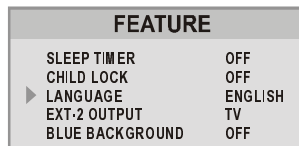

Setting External Source Output:

- You can use this menu to select the internal or external source that will be output at **EXT.2** terminal.
- In the “**FEATURE**” menu select “**EXT-2 OUTPUT**” using “**P** ^” or “**P** v” button. Then select the source you want to be output at **EXT.2** pressing “◀” or “▶” button (one of the sources: **TV, EXT-1, EXT-3** or **EXT-4 (Front AV)**).

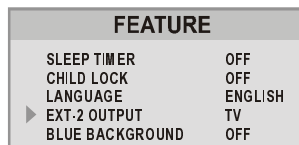

Blue Background During No-Signal:

The **BLUE BACKGROUND** feature can be set by “◀” or “▶” button to either **ON** or **OFF**.

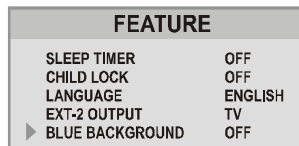

Install (Installation) Menu

You can store a channel manually, or modify the current settings of a channel (for example, fine-tuning a channel).

You can also changing the colour system, or change the **DECODER(EXT-2)** setting.

- Press “**MENU**” button to display the main menu.
- Press “**P** ^” or “**P** v” button to select “**INSTALL**” item. Then “◀” or “▶” button to display the “**INSTALL**” menu.

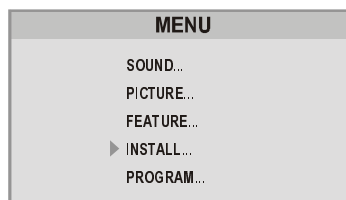

Note:

- If you want to modify the current settings of a channel, select the channel of which you want to modify the setting. Then display the main menu on screen.
- In AV mode, you can change only the “**COLOUR SYSTEM**” item.

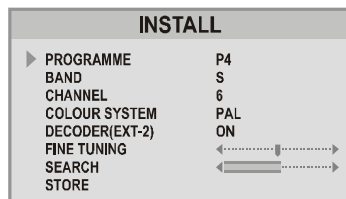

1. **PROGRAMME** will be the first selected item as you enter the **INSTALL** menu. Pressing “◀” or “▶” button select the programme number where you want to the tuned channel to be stored. (You may also type the programme number using the digit buttons.)

Note:

- Do not use **PROGRAMME** item when you modify the current programme number's setting. If you select other programme number by mistake, the selected programme number's setting will be changed.

2. Press “P ^” or “P v” button to select **BAND**. Using “◀” or “▶” button to select the band in which you want to search a channel.

3. Press “P ^” or “P v” button to select **SEARCH**. Press “◀” or “▶” button to start searching. (Press “▶” button to search forward. Press “▶” to search backwards.)

- If the found channel is not the desired one, press “◀” or “▶” button to start searching again.

- To stop searching before a channel is found, press the reverse direction button. For example, when the TV is searching forward with “▶” button, press “◀” button to stop searching.

- If you know the channel number which you want to find, you can find the channel directly. Follow the step 4 to select the correct standard, then press “P ^” or “P v” to select **CHANNEL** again, and press “◀” or “▶” button to select the channel number, or enter the number with the digit buttons.

4. If the picture is not clear or no colour appears, change the colour system to display the picture normally. Press “P ^” or “P v” button to select **COLOUR SYSTEM**, then press “◀” or “▶” button to choose the correct one.

- In TV mode: **PAL / SECAM**
- In AV mode: **AUTO / PAL / SECAM / NTSC 3.58 / NTSC 4.43**

5. If the channel reception is poor, fine-tune the channel. Press “P ^” or “P v” to select **FINE TUNING**, then press “◀” or “▶” button to fine-tune the channel.

6. After the all settings are completed, store the new channel's setting to the programme number which you selected. Press “P ^” or “P v” to select **STORE**, then press “◀” or “▶” button to store it. “**T-V LINK**” menu will appear after the TV stores the settings.

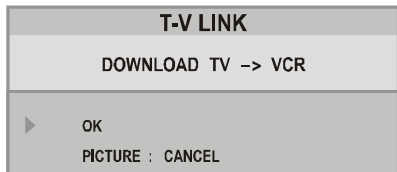

7. If you do not have a T-V LINK compatible VCR, press “**PICTURE**” button to exit the menu.

If you have a T-V LINK compatible VCR connected to the EXT.2 terminal, follow the operating procedure “**Downloading the data to VCR**” on **page 6** to transmit the Programme table data to the VCR.

To change the Colour system:

If the picture is not clear or no colour appears, choose the correct colour system to display the picture normally.

1. Press “P ^” or “P v” button to select **COLOUR SYSTEM**, then press “◀” or “▶” button to choose the correct one.

- In TV mode: **PAL / SECAM**
- In AV mode: **AUTO / PAL / SECAM / NTSC 3.58 / NTSC 4.43**

2. Press “P ^” or “P v” to select **STORE**, then press “◀” or “▶” button to store it.

3. When “**T-V LINK**” menu appears, follow the step 4.

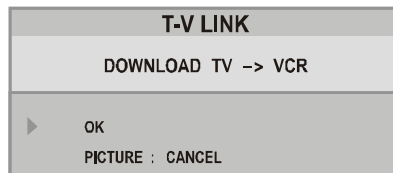

4. If you do not have a T-V LINK compatible VCR, press “**PICTURE**” button to exit the menu.

If you have a T-V LINK compatible VCR connected to the **EXT.2** terminal, follow the operating procedure “**Downloading the data to VCR**” on **page 6** to transmit the Programme table data to the VCR.

Using the Decoder (EXT-2) function

If you have a decoder connected to a **T-V LINK** compatible VCR, which in turn is connected to the **EXT.2** terminal, use **DECODER(EXT2)** to unscramble the scrambled TV channels.

- Exit the menu.
- Turn on the decoder power.
- Display the scrambled TV channel on the TV. Even if the decoder is working, a scrambled picture appears.
- Display the “**INSTALL**” menu again.
- Press “P ^” or “P v” button to select **DECODER(EXT-2)**, then press “◀” or “▶” button to set to “**ON**”
- Press “P ^” or “P v” to select **STORE**, then press “◀” or “▶” button to store it. “**T-V LINK**” menu will appear after the TV stores the setting.

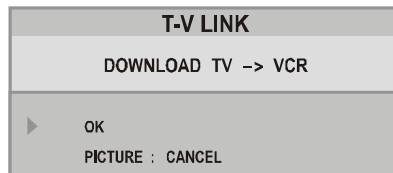

7. Follow the operating procedure “**Downloading the data to VCR**” on **page 6** to transmit the revised programme table data to the VCR.

- If you do not want to transmit, press “**PICTURE**” button to exit the menu.

Note:

You can only use this item if you have a decoder connected to a T-V LINK compatible VCR to EXT.2 terminal. Setting this item to “**ON**” by mistake causes the picture/sound of a TV channel you are currently viewing to disappear.

If this item has been set to “**ON**” but the TV channel cannot be unscrambled, check the following:

- Has the decoder been connected to the VCR properly according to the VCR and Decoder instruction manuals?
- Can the TV channel be unscrambled with a decoder?
- Do you need to change the VCR settings in order to connect the decoder? Confirm that the VCR is set properly by rechecking the VCR instruction manual.

Program (Programming) Menu

You can use the PROGRAM (Programming) menu to delete a channel, to change the programme number of a channel, to give a channel name to a channel, and to start the **AUTO PROGRAM (AUTOSTORE)** function.

- Press “**MENU**” button to display the main menu.
- Press “**P** ^” or “**P** v” button to select “**PROGRAM**” item, then “**◀**” or “**▶**” button to display the “**PROGRAM**” menu.

PROGRAM		
01 C 12	11 ---	21 ----
02 C 23	12 ----	22 ----
03 C 45	13 ----	23 ----
04 C 47	14 ----	24 ----
05 C 50	15 ----	25 ----
06 C 55	16 ----	26 ----
07 ----	17 ----	27 ----
08 ----	18 ----	28 ----
09 ----	19 ----	29 ----
10 ----	20 ----	30 ----
NAME	INSERT	
DELETE	AUTOSTORE	
i : T-V LINK		

To choose a channel in the PROGRAM menu:

- Press “**P** ^” / “**P** v” / “**◀**” / “**▶**” button. The programme number that you choose is high-lighted in the **PROGRAM** menu and you can view the picture of that channel.

Caution:

Using “**DELETE**” or “**INSERT**” function rewrite the current channel list in the **PROGRAM** menu. Therefore, the programme numbers of some of channels will change.

When you complete the settings of PROGRAM menu:

If you have a T-V LINK compatible VCR, press the “**Ⓜ**” button to display the T-V LINK menu. Then follow the operating procedure “**Downloading the data to VCR**” on **page 6** to transmit the Programme table data to the VCR.

T-V LINK	
DOWNLOAD TV → VCR	
▶ OK	
PICTURE : CANCEL	

If you do not have a T-V LINK compatible VCR, press “**PICTURE**” button to exit the menu.

To give a channel name (NAME):

1. Choose the channel you want to give a channel name.
2. Press the RED button to enter the NAME mode.
3. Press “**◀**” or “**▶**” button to choose the position, and press “**P** ^” or “**P** v” button to choose each character of channel name.
4. Press the RED button to store the channel name.
 - To cancel the NAME mode, press the BLUE button.

To delete a channel (DELETE):

1. Choose the channel you want to delete.
2. Press the YELLOW button to enter the DELETE mode.
3. Press the YELLOW button to delete it.
 - To cancel this DELETE mode, press the BLUE button.

To change the programme number of a channel (INSERT):

1. Choose the channel you want to change the programme number.
2. Press the GREEN button to enter the INSERT mode.
3. Press “**P** ^” / “**P** v” / “**◀**” / “**▶**” button to choose new programme number.
4. Press the GREEN button to insert the channel to the chosen programme number.
 - To cancel this INSERT mode, press the BLUE button.

To start AUTO PROGRAM (AUTOSTORE)

AUTO PROGRAM Automatically programmes the received channels in your TV's programme numbers.

1. Press the BLUE button to enter the **AUTOSTORE** mode. A warning message appears.

WARNING	
ALL PRESTORED PROGRAMMES WILL BE ERASED	
▶ COUNTRY CONTINUE	UK
PICTURE : CANCEL	

- To cancel the **AUTOSTORE** mode, press the “**PICTURE**” button.
2. Press “**P** ^” or “**P** v” button to choose the “**COUNTRY**”, then press “**◀**” or “**▶**” button the choose country you are now located.
 3. Press “**P** ^” or “**P** v” button to choose the “**CONTINUE**”, then press “**▶**” button to start **AUTO PROGRAM** The following message appears.

AUTO PROGRAM IS RUNNING PLEASE WAIT	
PICTURE : CANCEL	

- To cancel the **AUTO PROGRAM**, press the “**PICTURE**” button.
4. After **AUTO PROGRAM** is finalized, the **PROGRAM** menu appears again.

Other Features

Sound Mute

To cut off the sound of the TV, press “**⊗**” button. The sound will be cut off. To cancel mute, press “**⊗**” or “**△**” or “**▽**” button. The volume level will be the same as the level before mute when you cancel mute.

Stereo / Bilingual

- If the TV channel you are watching broadcasts in two languages (e.g. Eurosport), you can select the dubbed or the original language, pressing the “**Ⓜ**” button.
- When the stereo broadcast is received poorly, you can change from stereo to mono sound so that you can hear the broadcast more clearly and easily.



Information on Screen

First pressing the “**Ⓜ**” button displays the current status “**Programme number**”, “**Station name**” and “**Sound status**”.

Pressing this button again displays the current time.

Pressing this button once more remove the on-screen display.

To Display the Time

- While watching a TV programme with Teletext transmission press “” button twice. The current time information, captured from Teletext will be displayed at the upper left corner of the screen.
- If the programme being watched does not have Teletext transmission, no time information will be displayed.
- The time information will disappear after pressing “” button again.

Picture

You can change **Picture Mode** settings by pressing “**PICTURE**” button when no menu appears.

VCR / DVD Control Buttons and VCR / / DVD Switch

The buttons can be used to operate a JVC brand VCR or DVD player. Pressing the button having the same appearance as the original remote control button of a device makes the function work in the same way as the original remote control.

1. Set the VCR /  / DVD Switch to the VCR or DVD position.

VCR:

When you are operating the VCR, set the switch to the VCR position.

DVD:

When you are operating the DVD player, set the switch to the DVD position.

(Text):

When you are viewing Teletext programmes, set the switch to the  (Text) position.

2. Press the VCR / DVD Control Button to control your VCR or DVD player.

Note:

- If your device is not made by JVC, these buttons cannot be used.
- Even if your device is made by JVC, some of these buttons or any one of the buttons may not work, depending on the device.
- You can use the \wedge / \vee buttons to choose a TV channel which the VCR will receive or choose the chapter which the DVD player plays back.
- Some DVD player models use the \wedge / \vee buttons for operating of Fast forward/backward functions and choosing the chapter. In this case, the \lll / \ggg the buttons do not work.



Teletext

Teletext is an information system that displays text on your TV screen. Using the Teletext information system you can view a page of information on a subject that is available in the list of contents (index).

No on screen display will be available in text mode.

No contrast, brightness or colour control, but volume control is available in text mode.

To operate Teletext

- Select a TV station on which Teletext is being transmitted.
- Press (teletext)  button. Usually the list of contents (index) is displayed on the screen.
- Set the VCR /  / DVD switch to the  (Text) position.

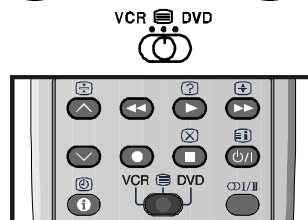

To select a page of Teletext

- Press the appropriate digit buttons for the required Teletext page number.

The selected page number is displayed at the top left corner of the screen. The Teletext page counter searches until the selected page number is located, so that the desired page is displayed on the screen.



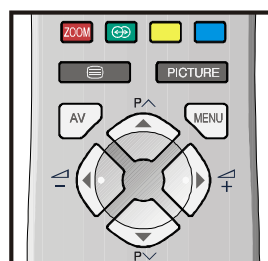

- Press “**P** \wedge ” button to move the Teletext screen forward one page at a time.
- Press “**P** \vee ” button to move the Teletext screen backward one page at a time.



To Select Index Page

- To select the page number of the index (generally page 100), press “” button.

Searching for a teletext page while watching TV

- In the Teletext mode pressing “” button will switch the screen to the TV mode. In the TV mode enter a page number using digit buttons. As you enter last digit of page number, “” sign will replace the page number and flash until the entered page number is found. Then the page number will replace “” sign again. Now you can display this teletext page pressing “” button.

To Select Double Height Text

- Press “” button for the top half of the information page to be displayed in double height text.

- Press “

To Reveal “concealed” Information

- Pressing “

To Stop Automatic Page Change

The teletext page you have selected may contain more information than what is on the screen; the rest of the information will be displayed after a period of time.

- Press “

To Select a Subcode Page

Subcode pages are subsections of long Teletext pages that can only be displayed on the screen one section at a time.

- Select the required Teletext page.
- Press “

To exit Teletext

- Press “

Fastext and Toptext

Teletext mode will be selected according to transmission automatically.

Your CTV supports the 7 page Teletext system. When the page number of any of the 7 pages in memory is entered, the system will not search for the requested page; instead it will display the page automatically.

- Press “**P** 

For Fastext and Toptext

The subject-heading for the information may have a particular colour or can be in a form located in a coloured box.

- Press an appropriate **RED**, **GREEN**, **YELLOW** or **BLUE** button in order to reach the relevant page quickly.

For TOPTXT

If Toptext transmission is present, colour coded buttons will appear in status row.

If Toptext transmission is not present, status row will not appear.

In Toptext mode the “**P** 

Connect the External Equipments

Via the Euroconnector

Your TV set has three Euroconnector sockets. If you want to connect equipments (e.g. video recorder, decoder, etc.) which have Euroconnectors, to your TV, use the **EXT.1 (EXT-1)**, **EXT.2 (EXT-2)** or **EXT.3 (EXT-3)** terminals.

If an external device is connected via Euroconnector sockets TV is switched to AV mode automatically.

T-V LINK compatible VCR

Be sure to connect the T-V LINK compatible VCR to the **EXT.1** terminal. If not, the T-V LINK function will not work properly.

- When connecting a T-V LINK compatible VCR to the **EXT.1** terminal, be sure to connect the decoder to the VCR. If not, the **T-V LINK** function may not work properly. And then set the **DECODER(EXT-2)** function for the channel to **ON** to unscramble a scrambled channel. For details, see “**Using the Decoder (EXT-2) function**” on **page 11**.

RGB mode

If an equipment can output the **RGB** signals, connect it to the **EXT.1 (EXT-1)** terminal.

EXT-2S Mode

If the equipment connected to your TV set supports S-Video (Y/C) output from Euroconnector, you can have a better picture quality by selecting **EXT-2S** mode and connecting your equipment to the **EXT.2 (EXT-2S)** terminal of TV. See your equipment's booklet to check if your equipment has such feature.

Via the RCA jacks

If you have an equipment (such as a Camcorder) which has the RCA jacks, connect it to the **Front AV (EXT-4)** terminal with the video and audio cables.

Via the ANT (aerial) socket

If your equipment does not have an Euroconnector or RCA jacks, connect it to the TV with an aerial cable. For details, see the manual provided with the equipment.

- To store the test signal that comes from the equipment, see “**INSTALL Menu**” on **page 10** and store it to the programme number 0. You can watch images from that equipment to select the programme number which you stored the test signal.

TV and Video Recorder (VCR)

- Connect the Video Recorder to the ANT (antenna input) socket of the TV with the aerial cable.
- Connect the Video Recorder to the **EXT.1 (EXT-1)**, **EXT.2 (EXT-2)** or **EXT.3 (EXT-3)** terminal with the SCART cable, or connect it to the **Front AV (EXT-4)** terminal with the audio and video cables.

Connect the External Equipments

Before connecting anything

- Switch off all equipments including the TV.
- Read the manuals provided with the equipments.

To select an AV mode

Pressing "AV" button on the remote control selects one of six AV modes (EXT-1, RGB, EXT-2, EXT-2S, EXT-3 or EXT-4)

- To return to the TV mode, repeatedly press "AV" button.

EXT.1 (EXT-1) terminal: Euroconnector (21-pin, SCART)

- Video input, Audio L/R inputs and RGB inputs are available.
- TV broadcast outputs (Video and Audio L/R) are available.

EXT.2 (EXT-2) terminal: Euroconnector (21-pin, SCART)

- Video input, S-VIDEO (Y/C) input and Audio L/R inputs are available.
- Video and Audio L/R outputs are available. (See "Setting External Source Output" on page 10.)
- T-V LINK functions are available. (See "T-V LINK compatible VCR" on page 14.)

EXT.3 (EXT-3) terminal: Euroconnector (21-pin, SCART)

- TV broadcast outputs (Video and Audio L/R) are available.

Front AV (EXT-4) terminal: RCA connectors x 3

- Video input and Audio L/R inputs are available.

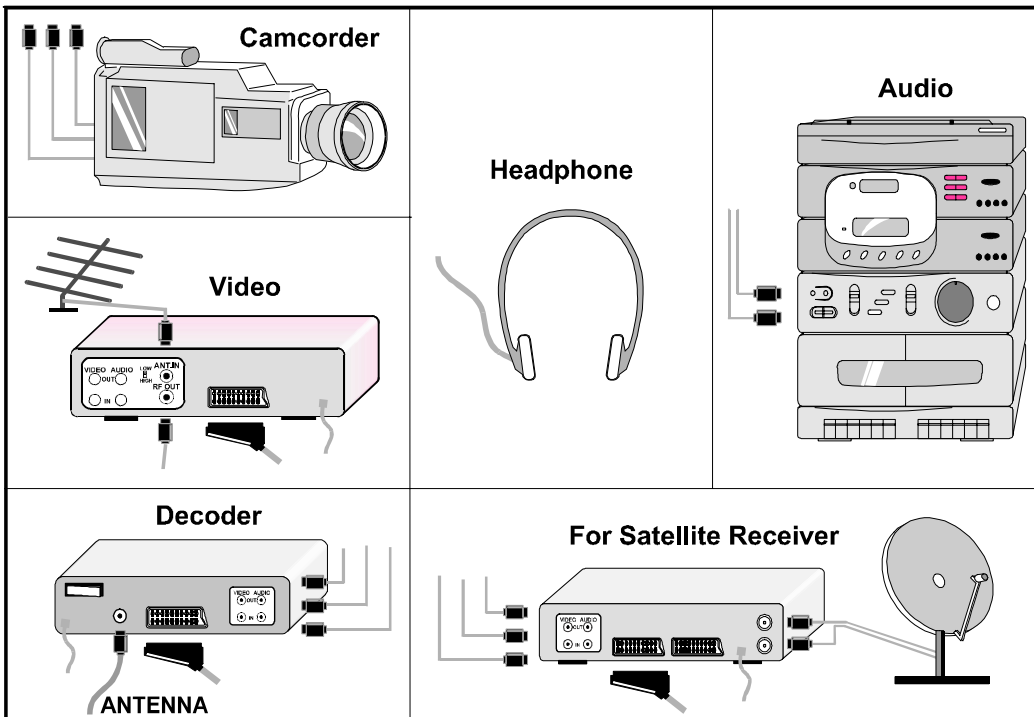
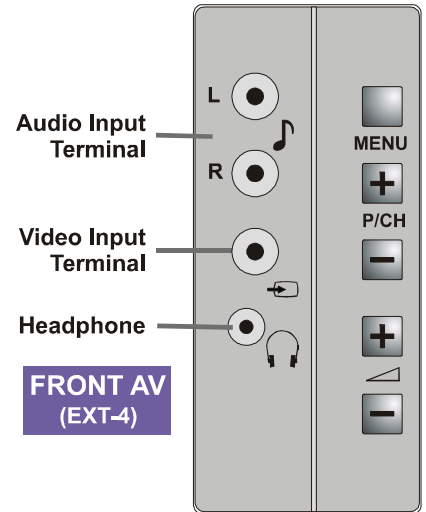
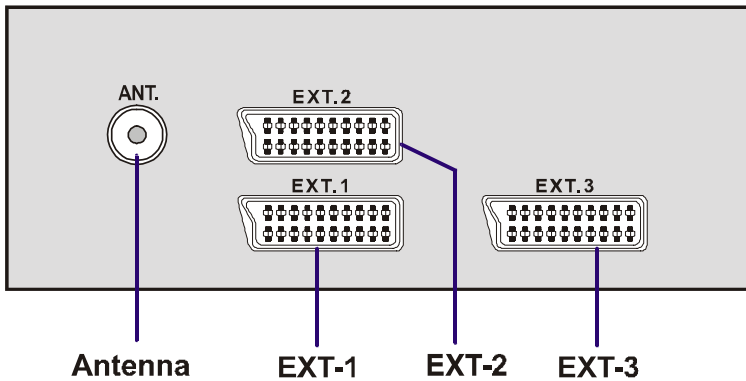

NTSC Playback

Connect a NTSC video recorder to a terminal. Then press "AV" button to select the corresponding AV mode.

NTSC 3.58/4.43 system is detected automatically in AV mode.

Copy Facility

You can output the video and audio signals which inputs from TV, EXT.1 (EXT-1) or EXT.3 (EXT-3) terminal to the video recorder connected to the EXT.2 (EXT-2) terminal.

- To select the output source, see "Setting External Source Output" on page 10.

Connecting Headphones

Use the stereo headphone socket of your TV, to connect headphones.

Tips

Care of the Screen

Clean the screen with a slightly damp, soft cloth. Do not use abrasive solvents as they may damage the TV screen coating layer.

Poor Picture

Have you selected the correct TV system? Is your TV set or house aerial located too close to the loudspeakers, non-earthed audio equipment or neon lights, etc. ?

Mountains or high buildings can cause double pictures or ghost images. Sometimes you can improve the picture quality by changing the direction of the aerial.

The picture quality may degrade when two peripherals are connected to the TV at the same time. In such a case, disconnect one of the peripherals.

No Picture

Is the aerial connected properly? Are the plugs connected tightly to the aerial socket? Is the aerial cable damaged? Are suitable plugs used to connect the aerial? If you are in doubt, consult your dealer.

No Picture means that your TV is not receiving any transmission. Have you pressed the correct keys on the remote control? Try once more.

Sound

Sound is coming from only one of the speakers. Is the balance set to one direction extreme? See SOUND menu.

Remote Control

Your TV no longer responds to the remote control. Perhaps the batteries are exhausted. If so you can still use the local buttons at the right side of your TV.

Have you selected the wrong menu? Press "PICTURE" button to return to TV mode or press "MENU" button to return to the previous menu.

No solution

Switch your TV set off and on. If this does not work, call the service personnel; never attempt to repair it yourself.

Specifications

TV BROADCASTING

PAL I

RECEIVING CHANNELS

VHF (BAND I/III)

UHF (BAND U)

HYPERBAND

CABLE-TV (S01-S41)

NUMBER OF PRESET CHANNELS

100

CHANNEL INDICATOR

ON SCREEN DISPLAY

RF AERIAL INPUT

75 Ohm Unbalanced

OPERATING VOLTAGE

220-240V AC, 50 Hz.

SOUND-MULTIPLEX SYSTEMS

Nicam Stereo

PICTURE TUBE

28" 16:9

AUDIO OUTPUT POWER (W_{RMS}) (%10 THD)

2 x 10

POWER CONSUMPTION (W) (max)

145 Watt

DIMENSIONS (WxHxD) (mm)

DIMENSIONS			
W	H	D	Weight (kg)
805	495	486	41