

Specifications

Model	AV-21FT	AV-21AT
TV RF systems	B, G, I, D, K, K1	
Colour systems	PAL, SECAM, NTSC 3.58 / 4.43 MHz (in VIDEO mode only)	
Channel and frequencies	VHF low channel (VL) = 46.25 to 168.25 MHz VHF high channel (VH) = 175.25 to 463.25 MHz UHF channel (U) = 471.25 to 863.25 MHz ■ Receives cable channels in mid band (X to Z, S1 to S10), super band (S11 to S20) and hyper band (S21 to S41) .	
Power input	AC110 to 240 V, 50 / 60 Hz	
Power consumption	Maximum 105 W, Average 68 W	
Screen size (measured diagonally)	Picture tube 55 cm Visible area 51 cm	
Audio output (Rated power output)	5W (monaural)	5W (monaural)
Speakers	(6 cm × 12 cm) oval × 2	(5 cm × 9 cm) oval × 2
External input / output	VIDEO input (RCA) AUDIO input (RCA) VIDEO output (RCA) AUDIO output (RCA) Headphone jack: mini jack (dia. 3.5 mm)	
Dimensions (W × H × D)	619 mm × 458 mm × 486.5 mm	502 mm × 451 mm × 480.5 mm
Weight	22 kg	19.5 kg
Accessories	• Remote control unit: RM-C364 × 1 • AA / R6 / UM-3 dry cell battery × 2	

Design and specifications subject to change without notice.



© 2000 VICTOR COMPANY OF JAPAN, LIMITED

 LCT0748-001A-H
0400-Ki-AB-NV-JMT

JVC

COLOUR TELEVISION

AV-21FT AV-21AT

INSTRUCTIONS

Thank you for purchasing this JVC colour television.
To ensure your complete understanding, please read this manual thoroughly before operation.

WARNING:

TO PREVENT FIRE OR SHOCK HAZARD, DO NOT EXPOSE THIS APPLIANCE TO RAIN OR MOISTURE.

CAUTION:

- TO ENSURE PERSONAL SAFETY, OBSERVE THE FOLLOWING RULES REGARDING THE USE OF THIS TV.
- Operate only from the power source specified on the TV.
- Avoid damaging the power plug and power cord.
- Avoid improper installation and never position this TV where good ventilation is unattainable. When installing this TV distance recommendations must be maintained between the floor and wall, as well as installment in a tightly enclosed area or piece of furniture. Adhere to the minimum distance guidelines shown for safe operation.
- Do not allow objects or liquid into the cabinet openings.
- In the event of a fault, unplug this TV and call a service technician. Do not attempt to repair it by yourself or remove the rear cover.
- When you don't use this TV for a long period of time, be sure to disconnect the power plug from the AC outlet.

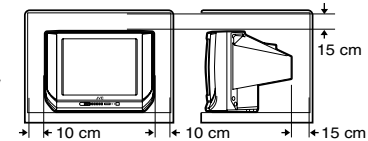

Contents

Locations	2
Preparation	4
Viewing a Television Programme	12
Viewing Images from an External Device	14
Sound and Picture	15
Other Features	17
Troubleshooting	23
Specifications	Back cover

Locations

Locations of remote control buttons

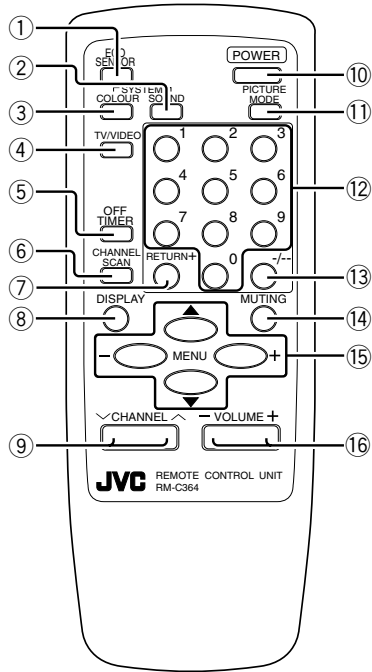

①	ECO SENSOR button	p.17
②	SOUND SYSTEM button	p.15
③	COLOUR SYSTEM button	p.15
④	TV/VIDEO button	p.14
⑤	OFF TIMER button	p.17
⑥	CHANNEL SCAN button	p.18
⑦	RETURN + button	p.18
⑧	DISPLAY button	p.17
⑨	CHANNEL ∇/\wedge buttons	p.12
⑩	POWER button	p.6, 12, 13
⑪	PICTURE MODE button	p.15
⑫	Number buttons	p.12
⑬	-/-- button	p.12
⑭	MUTING button	p.16
⑮	MENU buttons	
	• MENU $\blacktriangle/\blacktriangledown$ buttons	
	• MENU $-/+$ buttons	
⑯	VOLUME $-/+$ buttons	p.13

No. 56003

Locations

Locations of front panel buttons and lamps

<AV-21FT>

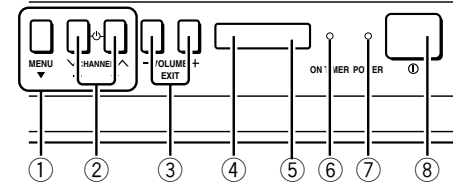
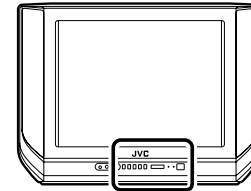

<AV-21AT>

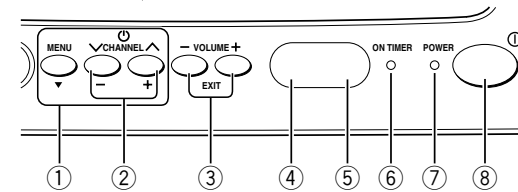
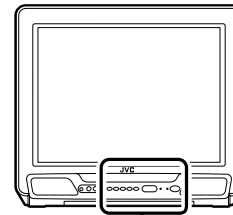

①	MENU buttons	p.22
	• MENU button	
	• MENU $-/+$ buttons	
②	CHANNEL ∇/\wedge buttons	p.13
③	VOLUME $-/+$ buttons	p.13

④	ECO sensor	
⑤	Remote control sensor	
⑥	ON TIMER lamp	p.19
⑦	POWER lamp	p.6, 13
⑧	Main power button	p.6, 13

Preparation

1. Connecting the aerial and external devices

Notes:

- For further details, refer to the manuals provided with the devices you are connecting.
- Connecting cables are not supplied.
- The front and rear AUDIO/VIDEO input jacks are directly connected so that input to either jack is output through both. You cannot provide input to both the front and rear jacks at the same time. Disconnect one input, or use one of the jacks as an output jack only (for monitoring or recording).

■ Connecting the aerial and VCR

If not connecting a VCR (video cassette recorder), do ①.

If connecting a VCR, proceed ① → ② → ③.

- You can view images from the VCR without doing ③. For details, see “To view images from a VCR connected to the TV with only an aerial cable” on page 14.

VHF/UHF outdoor aerial

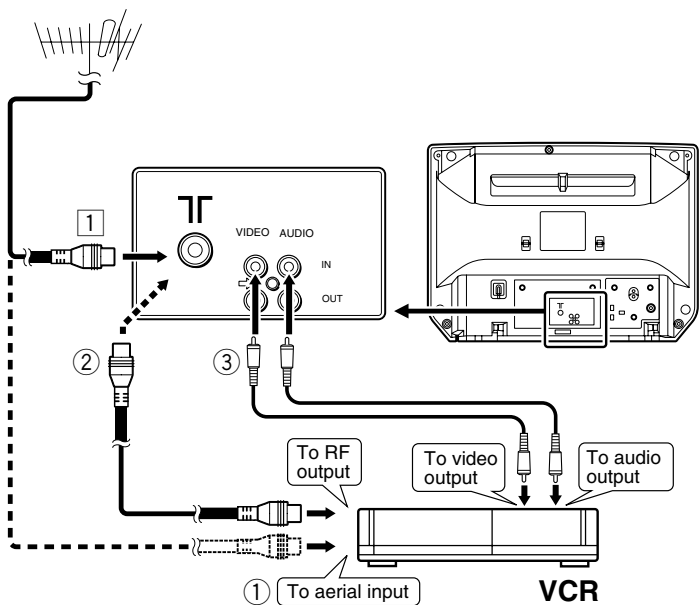

• Illustration of AV-21FT.

Preparation

■ Connecting other external devices

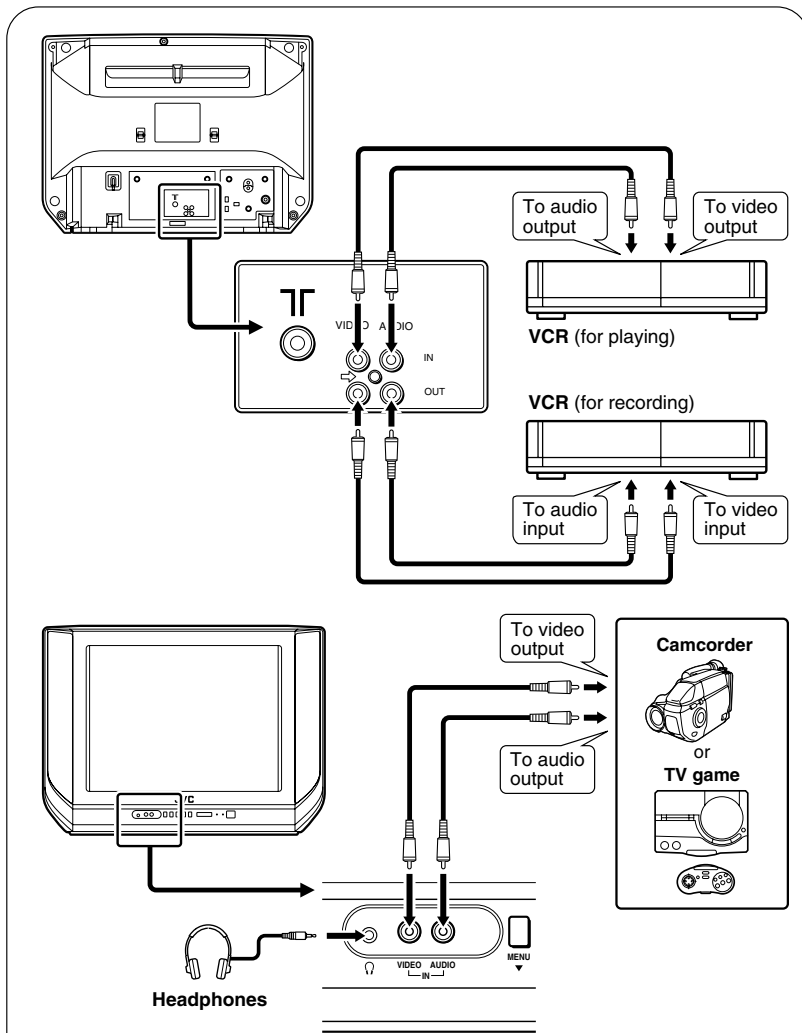

• Illustration of AV-21FT.

Note:

- Use headphones with a mini jack (dia. 3.5 mm). When using headphones, the speaker sound output is disabled.

Preparation

2. Connecting the power cord

Insert the Power plug into an AC outlet.

3. Inserting batteries into the remote control

Correctly insert two batteries, observing the ⊕ and ⊖ polarities and inserting the ⊖ end first.

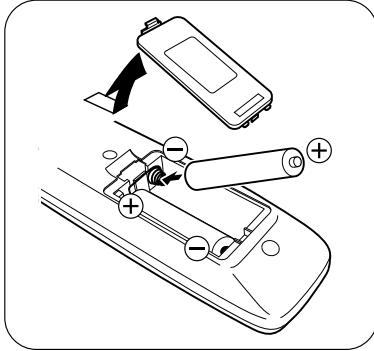

CAUTION:

- Follow the cautions printed on the batteries.

Notes:

- Use AA/R6/UM-3 dry cell batteries.
- Battery life is approximately six months to one year depending on frequency of use.
- If the remote control operates erratically, replace the batteries.
- We recommend that you use the supplied batteries initially and replace them as soon as operation becomes erratic. The supplied batteries are for testing, not regular use.

4. Turning your TV on

1. Press the Main power button on the TV to turn the TV's main power on.

The POWER lamp lights.

If image does not appear:

Your TV is in the standby mode. Press the POWER button on the remote control to turn your TV on.

- You can also turn on your TV by pressing the CHANNEL ∇/∧ button on your TV.

To turn your TV off:

Press the POWER button on the remote control. Your TV enters the standby mode.

To turn the TV's main power off:

Press the Main power button on the TV. The POWER lamp goes off.

Preparation

5. Selecting the on-screen language

You can select one of three languages for the on-screen display. The displayed menus on the screen are described in the selected language.

In this manual, on-screen descriptions are given in English. Select **ENGLISH**.

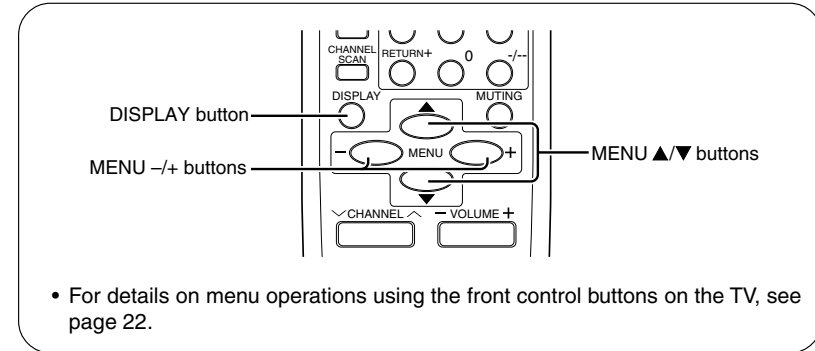

- For details on menu operations using the front control buttons on the TV, see page 22.

1. Press MENU ▲/▼ to display the following menu.

The following menu is displayed in one of three languages.

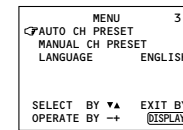

English

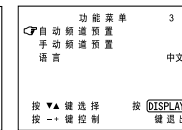

Chinese

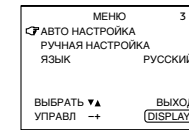

Russian

Notes:

- If a different menu is displayed, repeatedly press the MENU ▲/▼ button until this menu is displayed.
- If the menu appears in English, the TV's on-screen language is already set to English, so you can skip steps 2 and 3.

2. Press MENU ▲/▼ to select the third item on the menu.

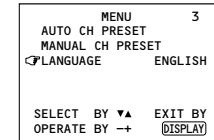

3. Press MENU +/- to select ENGLISH.

The menu is displayed in English.

4. Proceed to "6. Presetting TV stations" on the following page.

- If you want to complete operations at this stage, press the DISPLAY button to turn the menu display off.

Preparation

6. Presetting TV stations

To view a TV programme, you must first preset TV stations to channels on the TV. This TV has 100 channels (channel 1 to 99 and channel AV). You can choose between two functions, the Auto Channel Preset and Manual Channel Preset and preset TV stations to channels on TV.

Note:

- After you have finished presetting, you can set undesired channels to be skipped over, see page 11.

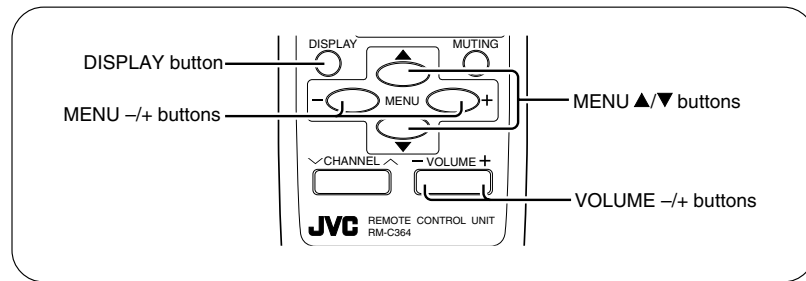

■ Auto Channel Preset

You can automatically preset all TV stations that can be received on your TV to channels in one simple operation.

Notes:

- When you use this function, no station is preset to the channel AV. Channel AV is offered for viewing images from a VCR connected to your TV with only an aerial cable. For more details, see page 14.
- If the Auto Channel Preset does not work well, preset TV stations manually, see page 9.

1. Press MENU ▲/▼ to select **AUTO CH PRESET**.

- If a different menu is displayed, repeatedly press the MENU ▲/▼ button until this menu is displayed.

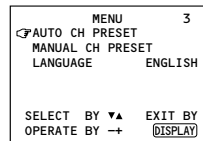

2. Press MENU -/+ to start the Auto Channel Preset function.

>>> **ON SEARCH** is displayed on the screen.

When you have finished presetting all TV channels that can be received on your TV, the display will go out and the Auto Channel Preset function will end.

- To stop the Auto Channel Preset, press the MENU -/+ button.

Preparation

■ Manual Channel Preset

You can manually preset the desired TV stations to the desired channels.

1. Press MENU ▲/▼ to select **MANUAL CH PRESET**.

- If a different menu is displayed, repeatedly press the MENU ▲/▼ button until this menu is displayed.

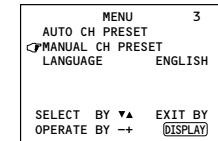

2. Press MENU -/+.

The sub-menu is displayed.

- The channel No. is displayed as a PR No. For example, channel 1 will be displayed as PR 1. However, channel AV will be displayed as AV.

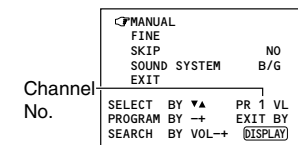

3. Press MENU -/+ to select the channel No. to be preset.

4. Press VOLUME -/+ to start selection of the TV station.

>>> or <<< is displayed on the screen.

When a TV station is received, the >>> or <<< display goes out, and the TV station is preset to the currently selected channel No.

- If you have selected the wrong TV station for preset, repeatedly press the VOLUME -/+ button until the desired TV station is selected.
- To stop the Manual Channel Preset, press any button other than the VOLUME -/+ button.

If the picture is not clear:

Use the Fine function to fine-tune the TV station.

1. Press MENU ▲/▼ to select **FINE**.

2. Hold VOLUME -/+ down to fine-tune the TV station so that the best image is displayed on screen.

> or < indicates that the TV station is being fine-tuned.

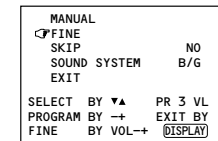

Continued on next page.



Preparation

5. Press MENU ▲/▼ to select **SOUND SYSTEM**.

6. Press VOLUME –/+ to select the appropriate sound system.

- For the sound systems in each country or region, refer to the table “The Broadcasting systems of Each country or Region”.

MANUAL			
FINE			
SKIP			NO
SOUND SYSTEM			B/G
EXIT			
SELECT BY ▼▲	PR 3 VL		
PROGRAM BY →←	EXIT BY		
CHANGE BY VOL→←	[DISPLAY]		

7. Press MENU ▲/▼ to select **MANUAL**.

8. Repeat steps 3 to 7 if you want to preset another TV station to a channel.

9. Press DISPLAY to turn the display off.

The Broadcasting Systems of Each Country or Region

Area	Country or Region	System	
		Colour	Sound
Asia, Middle East	Bahrain, Kuwait, Oman, Qatar, United Arab Emirates, Yemen, etc.	PAL	B/G
	Indonesia, Malaysia, Singapore, Thailand, India, etc.		
	China, Vietnam, etc.	PAL	D/K
	Hong Kong, etc.	PAL	I
Europe	Islamic Republic of Iran, Lebanon, Saudi Arabia, etc.	SECAM	B/G
	Russia, etc.	SECAM	D/K
	Czech Republic, Poland, etc.	PAL	D/K
	Germany, Holland, Belgium, etc.	PAL	B/G
Oceania	UK, etc.	PAL	I
	Australia, New Zealand, etc.	PAL	B/G
Africa	Republic of South Africa, etc.	PAL	I
	Nigeria, etc.	PAL	B/G
	Egypt, Morocco, etc.	SECAM	B/G

Preparation

■ Skip

When selecting channels, you can set undesired channels to be skipped. Channels set to be skipped cannot be selected by the CHANNEL V/∧ buttons nor the CHANNEL SCAN button.

- Channels to which a station has not been preset are automatically set to be skipped.

1. Press MENU ▲/▼ to select **MANUAL CH PRESET**.

- If a different menu is displayed, repeatedly press the MENU ▲/▼ button until this menu is displayed.

MENU	3
AUTO CH PRESET	
MANUAL CH PRESET	
LANGUAGE	ENGLISH
SELECT BY ▼▲	EXIT BY
OPERATE BY →←	[DISPLAY]

2. Press MENU –/+.

The sub-menu is displayed.

MANUAL			
FINE			
SKIP			NO
SOUND SYSTEM			B/G
EXIT			
SELECT BY ▼▲	PR 1 VL		
PROGRAM BY →←	EXIT BY		
SEARCH BY VOL→←	[DISPLAY]		

3. Press MENU ▲/▼ to select **SKIP**.

- The channel No. is displayed as a PR No. For example, channel 1 will be displayed as PR 1. However, channel AV will be displayed as AV.

Channel No.

MANUAL			
FINE			
SKIP			NO
SOUND SYSTEM			B/G
EXIT			
SELECT BY ▼▲	PR 1 VL		
PROGRAM BY →←	EXIT BY		
YES/NO BY VOL→←	[DISPLAY]		

4. Press MENU –/+ to select the channel you want to skip.

5. Press VOLUME –/+ to select **YES**.

The channel you selected is set to be skipped.

To cancel the Skip:
select **NO**.

MANUAL			
FINE			
SKIP			YES
SOUND SYSTEM			B/G
EXIT			
SELECT BY ▼▲	PR 5 VL		
PROGRAM BY →←	EXIT BY		
YES/NO BY VOL→←	[DISPLAY]		

6. Repeat steps 4 and 5 if you want to set another channel to skip.

7. Press DISPLAY to turn the display off.

Viewing a Television Programme

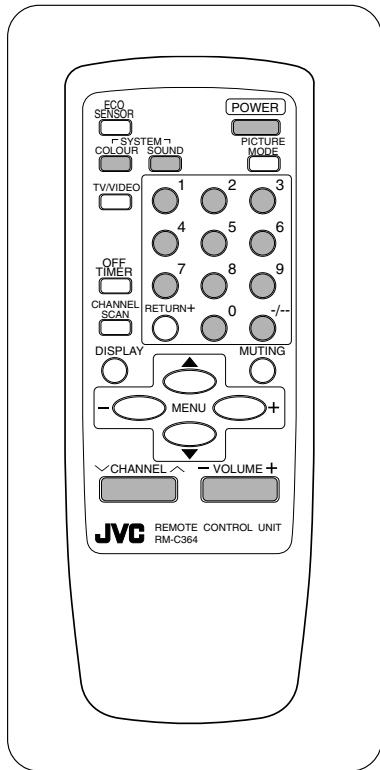

1. Press POWER to turn your TV on.



Notes:

- If your TV does not turn on, press the Main power button on the TV then press the POWER button again.
- You can also turn on your TV by pressing any of the following buttons;
 - the CHANNEL ∇/Δ button
 - the Number buttons
 - the TV/VIDEO button

2. Select a channel.

■ Up/ down selection

1. Press CHANNEL ∇/Δ .



Note:

- Up/down selection cannot be selected for channels to which the Skip has been set to **YES**. (See page 11.)

■ Direct selection

1. Repeatedly press the $-/--$ button to select the desired mode then press the Number buttons.

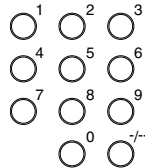

- : 1-digit mode

(example)
Channel 6 → Press 6.
Channel AV → Press 0.

-- : 2-digit mode

(example)
Channel 6 → Press 0, 6.
Channel 16 → Press 1, 6.
Channel AV → Press 0, 0.

If the colour is abnormal:

Repeatedly press the COLOUR SYSTEM button to select the appropriate colour system. For details, see "Colour System" on page 15.



Viewing a Television Programme

3. Press VOLUME $-/+$ to adjust the sound.



If the sound is abnormal:

Repeatedly press the SOUND SYSTEM button to select the appropriate sound system. For details, see "Sound System" on page 15.



4. To turn your TV off, press POWER.



Note:

- We recommend that you press the Main power button on the TV to turn the main power off if you do not plan to use your TV for a long time or if you wish to save energy.

Using the buttons on the TV

Condition:

- Check to make sure the Child Lock function is set to **OFF**. When the Child Lock function is set to **ON**, the TV cannot be operated using the front control buttons. For details, see "Child Lock" on page 20.

1. Press CHANNEL ∇/Δ to turn your TV on.



Note:

- If your TV does not turn on, press the Main power button and then press the CHANNEL ∇/Δ button again.

2. Press CHANNEL ∇/Δ to select a channel.



3. Press VOLUME $-/+$ to adjust the sound.



To turn your TV off:

Press the Main power button to turn the main power off. The POWER lamp goes off.



- If you press the Main power button again, your TV turns on immediately. Step 1 is no longer required.

- Illustration of AV-21FT.

Viewing Images from an External Device

You can view images from VCRs or other external devices connected to your TV.

1. Press TV/VIDEO to select the VIDEO mode.

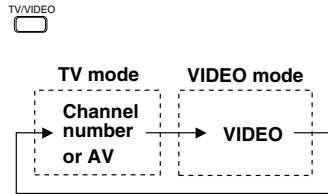

TV mode:

This mode is for viewing TV programmes. Press the TV/VIDEO button, or press the CHANNEL ∇/\wedge buttons, or press the number buttons to return to this mode.

To view images from a VCR connected to the TV with only an aerial cable:

Your VCR must be preset to the channel AV of this TV. Thoroughly read the manual of your VCR, and preset your VCR to the channel AV using the Manual Channel Preset function on page 9. As a result, you can view images from your VCR when you select the channel AV in the TV mode.

If the colour is abnormal:
Repeatedly press the COLOUR SYSTEM button to select the appropriate colour system. For details, see "Colour System" on page 15.

To select the VIDEO mode via MENU operation:

1. Press MENU $\blacktriangle/\blacktriangledown$ to display the MENU 1 and select INPUT.

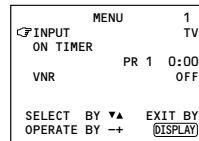
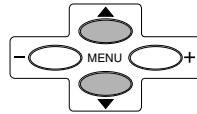

2. Press MENU $-/+$ to select the VIDEO mode.

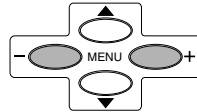

TV mode changes to VIDEO mode.

Sound and Picture

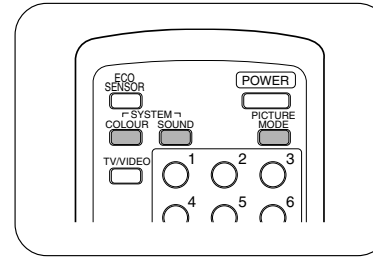

Colour System

If the colour is abnormal, select the appropriate colour system. Each press of the COLOUR SYSTEM button changes the colour system as follows.

In TV mode (channel 1 to 99 and AV):



In VIDEO mode:

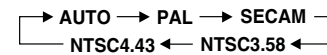

AUTO:

Automatic colour system selection.

Notes:

- For the colour systems in each country or region, see the table "The Broadcasting Systems of Each Country or Region" on page 10.
- If the colour is abnormal even though you selected **AUTO**, change the appropriate colour system manually.

Sound System

If the sound is abnormal, select the appropriate sound system. Each press of the SOUND SYSTEM button changes the sound system as follows.



Notes:

- For the sound systems in each country or region, see the table "The Broadcasting Systems of Each Country or Region" on page 10.
- You cannot select any sound system when in VIDEO mode.

Picture Mode

You can select one of three picture adjustment modes.

Repeatedly press the PICTURE MODE button to select the desired mode.

BRIGHT:

Heightens contrast and sharpness.

STANDARD:

Standardizes picture adjustments.

SOFT:

Softens contrast and sharpness.

Note:

- Pressing the PICTURE MODE button returns all the picture settings in the **MENU 4** menu to their default settings.

Sound and Picture

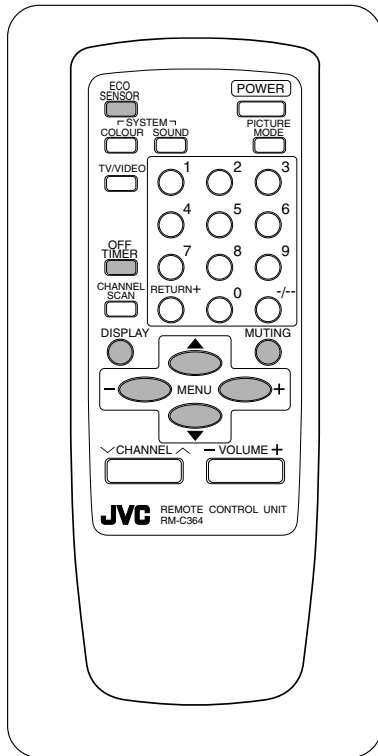

No. 56003

Muting

You can turn the volume off instantly. This is convenient when answering the phone or when you have visitors. Press the MUTING button. To return the sound, press the MUTING button again.

Picture Adjustment

You can adjust the picture as you like.

1. Press MENU $\blacktriangle/\blacktriangledown$ repeatedly to display the MENU 4.

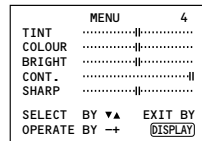

2. Press MENU $\blacktriangle/\blacktriangledown$ to select an item and press MENU $-/+$ to adjust it.

-	Item	+
Reddish	TINT (tint)	Greenish
Lighter	COLOUR (colour depth)	Deeper
Darker	BRIGHT (brightness)	Brighter
Lower	CONT. (contrast)	Higher
Softer	SHARP (sharpness)	Sharper

Note:

- **TINT** (tint) is displayed only when viewing images from NTSC3.58 or NTSC4.43 colour systems.

3. Press DISPLAY to turn the display off.

Other Features

Display

You can continuously display the current channel number or VIDEO mode on the screen. Press the DISPLAY button. To turn the display off, press the DISPLAY button again.

Note:

- When selecting a channel or VIDEO mode with no input signal, indication of selected channel or VIDEO mode becomes fixed on the screen.

Off Timer

You can set this TV to turn off automatically within a specified period of time.

Repeatedly press the OFF TIMER button to select the period of time.

- You can set the period of time a maximum of 120 minutes in 10 minute increments.
- 1 minute before the Off Timer turns off the TV, **GOOD NIGHT!** displays.

To display the remaining time:
Press the OFF TIMER button once.

To cancel the Off Timer:
Press the OFF TIMER button to return the period of time to 0.

Note:

- The Off Timer will not turn off the TV's main power.

Eco Sensor

You can adjust this TV so that the screen automatically adjusts to the optimum contrast according to the brightness of your room. This function reduces eye strain and the power consumption of this TV. Repeatedly press the ECO SENSOR button to select the desired mode.

ECO SENSOR DISPLAY:

The Eco Sensor function will work. In this mode, the heart mark \heartsuit indicating the brightness of your room is displayed for several seconds each time the brightness changes. The number of heart marks displayed on screen increases as your room becomes darker.

ECO SENSOR:

The Eco Sensor function will work. However, in this mode, the heart mark \heartsuit will not be displayed even if the brightness of your room changes.

ECO SENSOR OFF:

The Eco Sensor function will not work.

Other Features

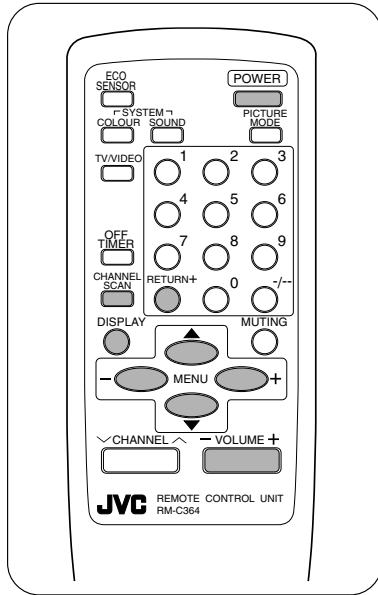

Channel Scan

You can search for the channel you want to view while scanning all of the channels that can be viewed on this TV.

1. Press CHANNEL SCAN.

Channels will be scanned in channel No. order.

2. When the channel that you want to view appears, press CHANNEL SCAN again before scanning for the next channel begins.

Note:

- Channel Scan selection cannot be selected for channels to which the Skip has been set to **YES**. (See page 11.)

Return +

By setting a channel to "Return channel", you can return to that channel with one touch.

1. Press CHANNEL V/∧ or the Number buttons to select a channel to set to "Return channel".
2. Press RETURN + for more than 3 seconds continuously. **RETURN PLUS PROGRAMMED!** appears.
3. When viewing another channel, press RETURN +. The channel changes to the channel set for "Return channel".

To cancel the channel set for "Return channel":

Press the RETURN + button for more than 3 seconds continuously.

- **RETURN PLUS CANCELLED!** appears.

Notes:

- When you turn the TV off, the "Return channel" setting will be canceled.
- When you press the RETURN + button while viewing the channel set for "Return channel", the channel changes to the previously viewed channel.
- When you press the RETURN + button while in a VIDEO mode, the mode switches to TV mode. To return to the channel set for "Return channel", press the RETURN + button again.

When there is no setting for "Return channel":

When you press the RETURN + button, the channel changes to the previously viewed channel.

On Timer

Your TV will automatically turn on and tune into the channel you want after a certain period of time you have specified.

1. Press MENU ▲/▼ repeatedly to display the **MENU 1**.
2. Press MENU ▲/▼ to select **ON TIMER**.

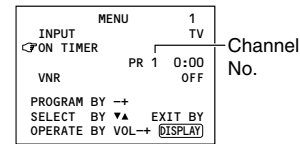

3. Press MENU -/+ to select a channel you want to view when the TV turns on.

Note:

- You cannot select the channel AV, the VIDEO modes, and the channels for which the Skip is set (See page 11).

4. Press VOLUME -/+ to select the period of time after which you want to turn on the TV. The ON TIMER lamp lights and the On Timer starts.

- Each time you press the button, the period of time changes in 15 minute intervals (up to 12 hours).

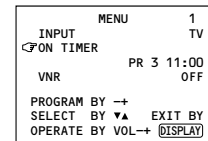

To cancel the On Timer:

Press the VOLUME -/+ button to return the period of time to **0:00**.

Other Features

5. Press DISPLAY to turn the display off.

6. Press POWER to turn the TV off.

The ON TIMER lamp will stay lit.

Notes:

- If you turn off the TV's main power by pressing the Main power button, the On Timer setting is canceled.
- If you do not turn off the TV after starting the On Timer, once the time set for the On Timer is reached, the channel will automatically switch to the channel set for the On Timer.

While the On Timer is operating:

The ON TIMER lamp lights.

When the time set for the On Timer is reached:

The TV automatically turns on and the channel set for the On Timer is displayed.

Notes:

- For safety reasons the TV will automatically turn off if no operations are made within approximately two hours after the TV is turned on with the On Timer.
- The Off Timer and Auto Shutoff have priority over the On Timer.

Other Features

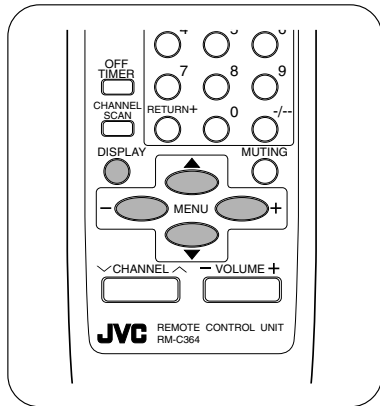

VNR (Video Noise Reduction)

You can reduce the picture noise.

1. Press **MENU** ▲/▼ repeatedly to display the **MENU 1**.
2. Press **MENU** ▲/▼ to select **VNR**.

MENU	1
INPUT	TV
ON TIMER	PR 1 0:00
☐ VNR	OFF
SELECT BY ▼▲	EXIT BY
OPERATE BY →	[DISPLAY]

3. Press **MENU** -/+ to select **ON**.

☐ VNR	ON
-------	----

ON:

Activates the VNR. Select **ON** when viewing a noisy picture.

OFF:

Cancels the VNR.

4. Press **DISPLAY** to turn the display off.

Child Lock

You can disable the front control buttons of the TV. When this function is set to **ON**, the TV can be operated using only the remote control.

Use this function to prevent children from operating the TV at their own discretion (without parental consent).

1. Press **MENU** ▲/▼ repeatedly to display the **MENU 2**.
2. Press **MENU** ▲/▼ to select **CHILD LOCK**.

MENU	2
AUTO SHUTOFF	OFF
☐ CHILD LOCK	OFF
BLUE BACK	ON
SELECT BY ▼▲	EXIT BY
OPERATE BY →	[DISPLAY]

3. Press **MENU** -/+ to select **ON**.

☐ CHILD LOCK	ON
--------------	----

ON:

Activates the Child Lock, disabling operation of the TV using the front control buttons.

OFF:

Cancels the Child Lock.

4. Press **DISPLAY** to turn the display off.

Note:

- The Child Lock is canceled when you turn the TV's main power off.

.....

Other Features

Auto Shutoff

You can set your TV to turn off if no signals are received for about 15 minutes or longer after the end of a broadcast.

1. Press **MENU** ▲/▼ repeatedly to display the **MENU 2**.
2. Press **MENU** ▲/▼ to select **AUTO SHUTOFF**.

MENU	2
☐ AUTO SHUTOFF	OFF
CHILD LOCK	OFF
BLUE BACK	ON
SELECT BY ▼▲	EXIT BY
OPERATE BY →	[DISPLAY]

3. Press **MENU** -/+ to select **ON**.

☐ AUTO SHUTOFF	ON
----------------	----

ON:

Activates the Auto Shutoff.

OFF:

Cancels the Auto Shutoff.

4. Press **DISPLAY** to turn the display off.

Notes:

- The Auto Shutoff function does not turn off the TV's main power.
- The Auto Shutoff will not work for a VIDEO mode.

.....

Blue Back

You can mute the sound and change the picture into a blue screen while no signals come into the TV, or when the input signals are unstable.

1. Press **MENU** ▲/▼ repeatedly to display the **MENU 2**.
2. Press **MENU** ▲/▼ to select **BLUE BACK**.

MENU	2
AUTO SHUTOFF	OFF
CHILD LOCK	OFF
☐ BLUE BACK	OFF
SELECT BY ▼▲	EXIT BY
OPERATE BY →	[DISPLAY]

3. Press **MENU** -/+ to select **ON**.

☐ BLUE BACK	ON
-------------	----

ON:

Activates the Blue Back.

OFF:

Cancels the Blue Back.

Notes:

- To view a broadcast even when the reception signal is poor, set the Blue Back to **OFF**.
- Even when the Blue Back is set to **OFF**, the sound may not be audible.
- The Blue Back function does not operate in VIDEO mode.

.....

4. Press **DISPLAY** to turn the display off.

Other Features

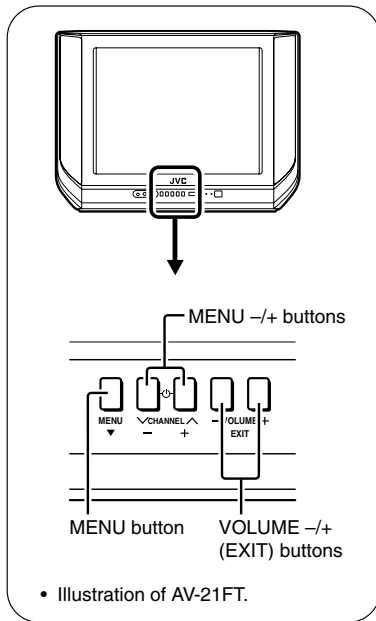

Menu operations using the buttons on the TV

You can operate functions in menus using the front control buttons on the TV without having to use the remote control.

Condition:

- Check to make sure the Child Lock function is set to **OFF**. When the Child Lock function is set to **ON**, the TV cannot be operated using the front control buttons. For details, see "Child Lock" on page 20.

1. Press MENU to display the menu.

If the desired menu is not displayed:

Repeatedly press the MENU button until the desired menu is displayed.

2. Repeatedly press MENU to select the desired function or item.

To select a function or item above the currently selected function or menu:

Repeatedly press the MENU button to proceed to another menu, and then repeatedly press the MENU button again to return to the original menu. Then select the function or item.

3. Press MENU +/- or VOLUME +/- to carry out the desired operation.

- For details, see the description for the respective function.

4. Press VOLUME +/- to turn the menu display off.

If the sub-menu is displayed:

The sub-menu cannot be turned off by the VOLUME +/- button when it is displayed. Follow the procedure below to turn the sub-menu display off.

1. Press MENU to select EXIT.

```

MANUAL
FINE
SKIP NO
SOUND SYSTEM B/G
EXIT
SELECT BY ▼▲ PR 1 VL
PROGRAM BY →← EXIT BY
EXIT BY VOL→ [DISPLAY]
  
```

2. Press VOLUME +/- to turn the sub-menu display off.

Troubleshooting

Important: Review all the instructions in this manual.

Problem	Check/Action
Cannot turn TV on	Press the Main power button (see p.6). Insert the power plug in an AC outlet.
No picture nor sound	Press the TV/VIDEO button to select the correct mode (see p.14). Check the aerial connections.
Remote control inoperable	Replace the batteries (see p.6). Insert the batteries correctly.
Buttons on front of TV do not work	Is the Child Lock function ON ? (see p.20).
The TV turns on suddenly	The TV will automatically turn on when the On Timer is operated (see p.19).
The TV turns off suddenly	The TV will automatically turn off in the following cases. <ul style="list-style-type: none"> • When the Off Timer or Auto Shutoff is operated (see p.17 and p.21). • When no operations are made within approximately two hours after the TV was turned on with the On Timer (see p.19).
Abnormal sound	Select the appropriate sound system (see p.15).
Abnormal colour	Adjust the colour and brightness (see p.16). Select the appropriate colour system (see p.15). Set the Picture mode to STANDARD (see p.15).
Lines or streaks in picture (interference)	Move the components apart until the interference disappears. Reposition the aerial.
Spotted picture (crosstalk)	Move the aerial away from the source of interference. Replace the aerial cable with a coaxial cable, which is less prone to interference.
Double picture (ghost)	Reposition the aerial. Replace with an aerial with good directionality.
Snowy picture (image noise)	Check the aerial connection and aim it correctly. Replace or repair the aerial.
The TV channel changes suddenly	The channel will automatically be changed when the On Timer operates (see p.19).
The screen turns blue	Is the Blue Back set to ON ? (see p.21).

The following are normal occurrences and are not the result of TV malfunctions:

- When a still bright image (of a white dress, for example) appears on the screen, the image may be coloured. This problem occurs in all CRTs, and when the bright image disappears, the colouration also disappears.
- This TV is equipped with a microcomputer that may operate abnormally due to interference from external devices. If this happens, press the Main power button to turn the main power off and disconnect the power plug from the AC outlet. Then, reconnect the power plug to the AC outlet and press the Main power button again.