

# JVC

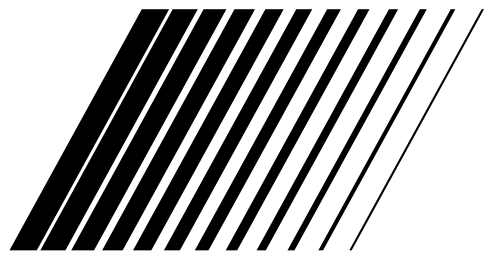

## COLOR TELEVISION

---

**AV-21YT11**

**AV-20NT11**

**AV-14FT11**

**AV-21YN11**

**AV-20NN11**

**AV-14FN11**

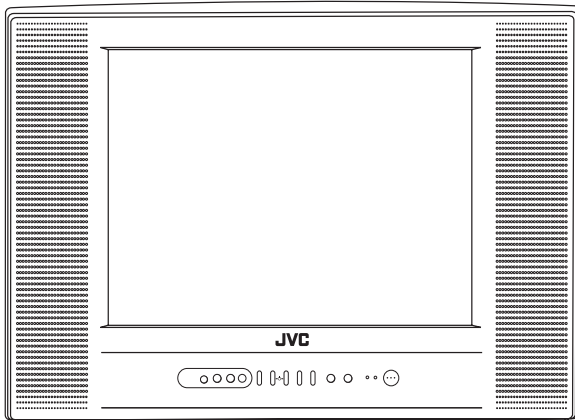

## ***INSTRUCTIONS***



GGT0006-001A-H  
0303-NIC-JMT

© 2003 VICTOR COMPANY OF JAPAN, LIMITED



Thank you for purchasing this JVC color television.

To ensure your complete understanding, please read this manual thoroughly before operation.

**WARNING:**

TO PREVENT FIRE OR SHOCK HAZARD, DO NOT EXPOSE THIS APPLIANCE TO RAIN OR MOISTURE.

**CAUTION:**

TO ENSURE PERSONAL SAFETY, OBSERVE THE FOLLOWING RULES REGARDING THE USE OF THIS TV.

- Operate only from the power source specified on the TV.
- Avoid damaging the power cord and main plug. When you unplug the TV, pull it out by the main plug. Do not pull on the power cord.
- Never block or cover the cabinet opening for ventilation. Never install the TV where good ventilation is unattainable. When installing this TV, leave spaces for ventilation around the TV more than the minimum distances shown in the diagram.

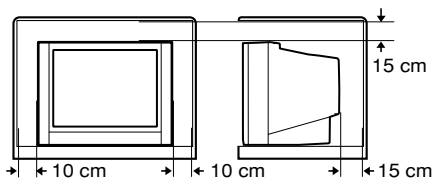

- Do not allow objects or liquid into the cabinet openings.
- In the event of a fault, unplug the TV and bring to JVC service centre. Do not attempt to repair it by yourself or remove the rear cover.
- The surface of the TV screen is easily damaged. Be very careful with it when handling the TV. Should the TV screen become soiled, wipe it with a soft dry cloth. Never rub it forcefully. Never use any cleaner or detergent on it.
- When you don't use this TV for a long period of time, be sure to disconnect the power plug from the AC outlet.
- The apparatus shall not be exposed to dripping or splashing and that no objects filled with liquids, such as vases, shall be placed on the apparatus.

**TABLE OF CONTENTS**

**CONNECTIONS**

Front & Rear Panel Diagrams ..... 3  
 Indoor Antenna Connection ..... 3  
 Connecting the Antenna and VCR ..... 4  
 Connecting other External Devices ..... 4

**GETTING STARTED**

Remote Controls ..... 6  
 Power ..... 7  
 Adjusting Volume ..... 7  
 Changing Channels ..... 7  
 SETUP TOUR ..... 8

**MENU FUNCTIONS**

Using the Menu ..... 9  
 Initial Setup  
     *Auto Tuner Setup* ..... 10  
     *Background* ..... 10  
     *Closed Caption* ..... 10  
     *Language (for on-screen menus)* ..... 10  
     *Noise Muting* ..... 10  
 Picture Settings  
     *Tint* ..... 11  
     *Color* ..... 11  
     *Picture* ..... 11  
     *Bright* ..... 11  
     *Detail* ..... 11  
 Sound Settings  
     *Bass* ..... 12  
     *Treble* ..... 12  
     *Balance* ..... 12  
     *MTS (Multi-channel TV Sound)* ..... 12  
     *Some Sound Advice* ..... 12  
 General Items  
     *Set Clock* ..... 13  
     *On/Off Timer* ..... 13  
     *Channel Summary* ..... 14  
     *Set Lock Code* ..... 15  
     *Child Lock* ..... 15

**BUTTON FUNCTIONS**

Display ..... 16  
 Closed Caption ..... 16  
 Video Status ..... 16  
 Sleep Timer ..... 16  
 Hyper Surround ..... 16  
 Number Buttons (10 Key Pad) ..... 17  
 100+ ..... 17  
 Muting ..... 17  
 Menu Buttons ..... 17  
 TV/Video ..... 17  
 Color System ..... 17  
 Return+ ..... 18  
 Picture Booster ..... 18

**APPENDICES**

Troubleshooting ..... 19  
 Specifications ..... Back cover

## FRONT & REAR PANEL DIAGRAMS

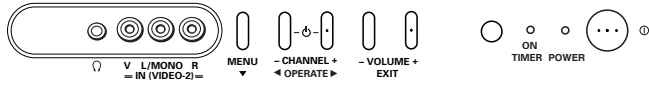

**AV-21YT11 Front Panel**

**AV-21YT11  
AV-20NT11  
AV-14FT11  
Rear Panel**

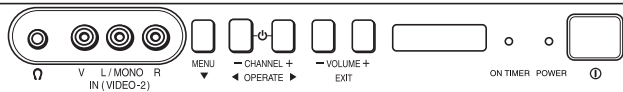
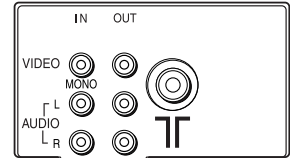

**AV-20NT11/AV-14FT11 Front Panel**

**AV-21YN11  
AV-20NN11  
AV-14FN11  
Rear Panel**

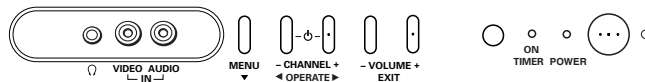
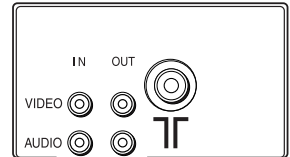

**AV-21YN11 Front Panel**

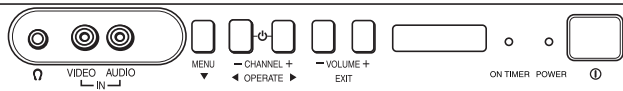

**AV-20NN11/AV-14FN11 Front Panel**

## INDOOR ANTENNA CONNECTION

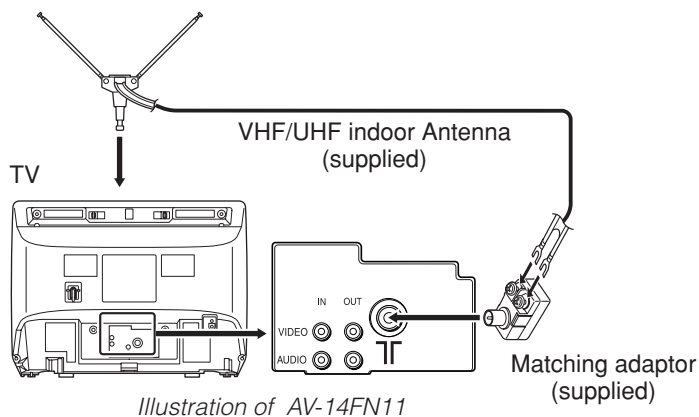

### To Install rod aerial:

Install into the top-rear aerial holder. Once installed, it cannot be removed. You can connect an indoor antenna included.

- 1) Connect the indoor antenna to the Matching adaptor and connect the Matching adaptor to the TV RF input.
- You will receive the best reception, or best picture, if you use connect your TV to an outdoor antenna of a cable output.

## CONNECTING THE ANTENNA AND VCR

- For further details, refer to the manuals provided with the devices you are connecting.
- Connecting cables are not supplied.

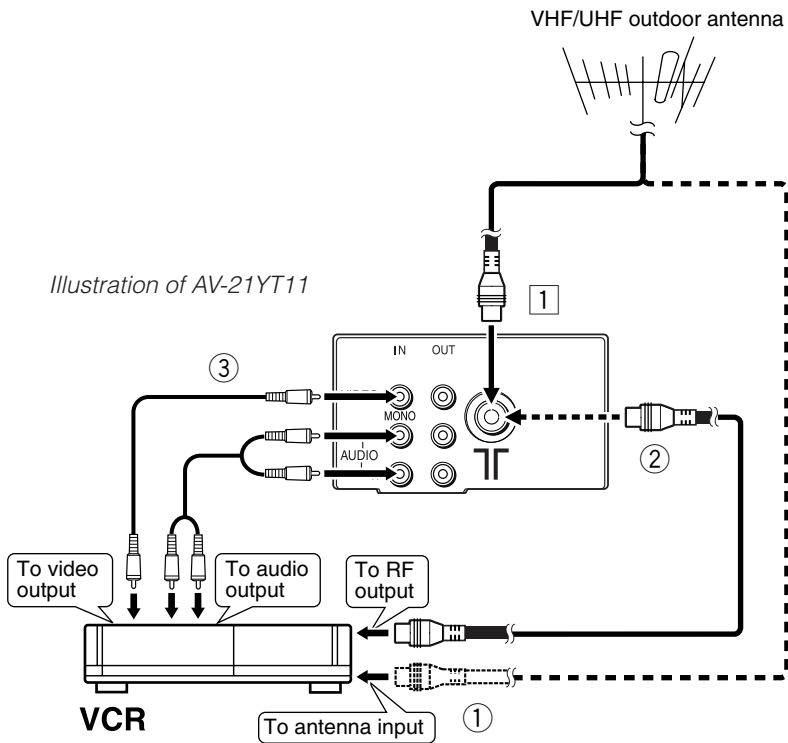

If not connecting a VCR, do ①.  
If connecting a VCR, proceed ① → ② → ③.

- You can view images from the VCR without doing ③.

**Note:** When connecting monaural audio to the TV, use the L/MONO jack.

**Note:** The sound and picture that you are watching are output from VIDEO/AUDIO (L/R) output jacks on the rear panel.

**Note:** The front and rear AUDIO/VIDEO input jacks are directly connected so that input to either jack is output through both. You cannot provide input to both the front and rear jacks at the same time. Disconnect one input, or use one of the jacks as an output jack only (for monitoring or recording).

## CONNECTING OTHER EXTERNAL DEVICES

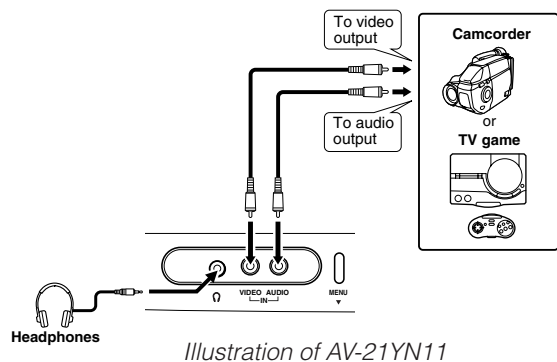
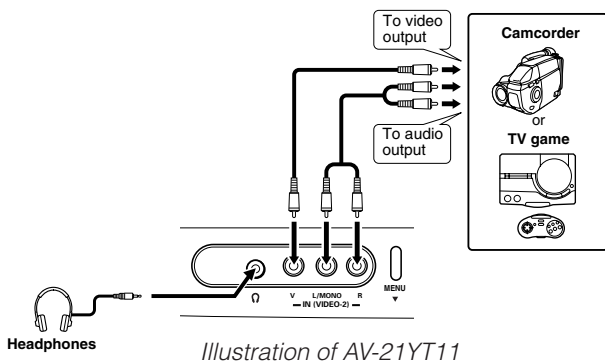

**Note:** Use headphones with a stereo mini jack. When using headphones, the speaker sound output is disabled.

## CONNECTING OTHER EXTERNAL DEVICES

Illustration of AV-21YT11

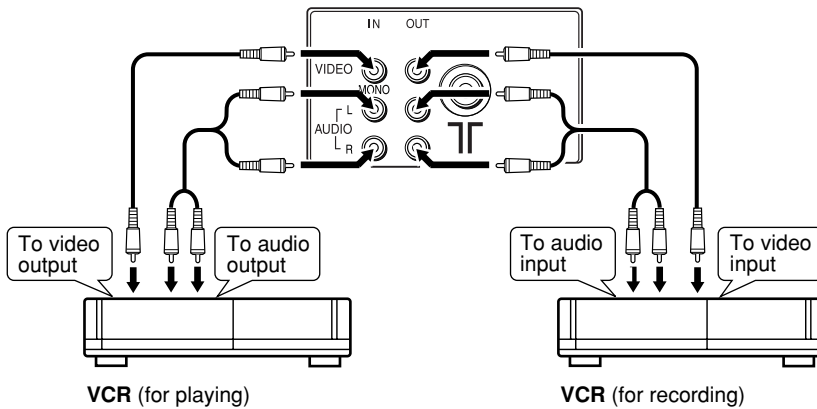

**Note:** When connecting monaural audio to the TV, use the L/MONO jack.

**Note:** The sound and picture that you are watching are output from VIDEO/AUDIO (L/R) output jacks on the rear panel.

Illustration of AV-21YN11

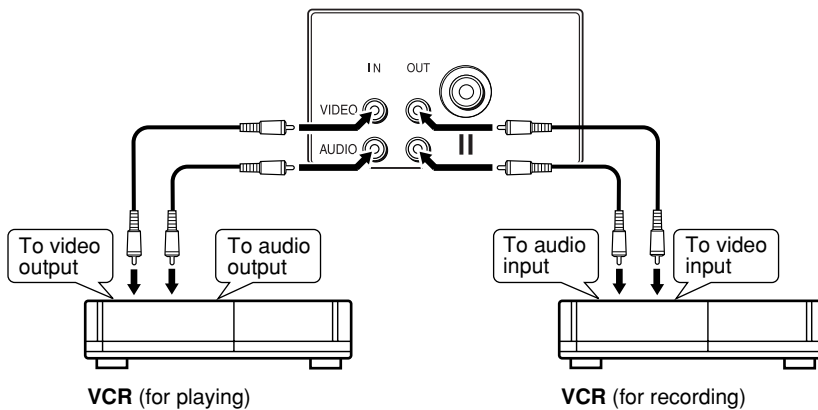

**Note:** The front and rear AUDIO/VIDEO input jacks are directly connected so that input to either jack is output through both. You cannot provide input to both the front and rear jacks at the same time. Disconnect one input, or use one of the jacks as an output jack only (for monitoring or recording).



# GETTING STARTED

## REMOTE CONTROLS

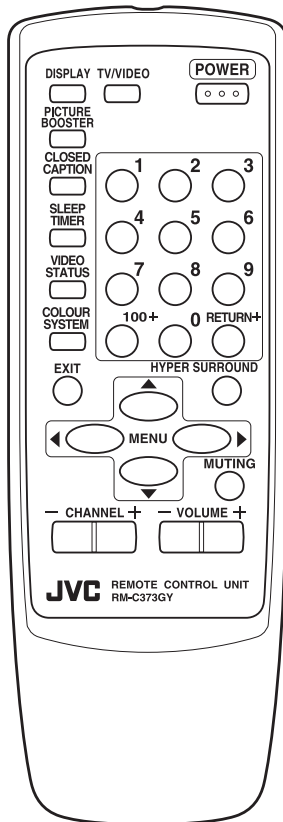

RM-C373GY

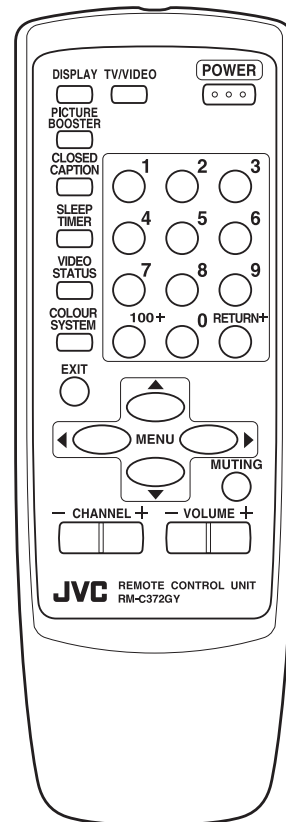

RM-C372GY

### CHANGING THE BATTERIES

Be sure to use only size AA/R6/UM-3 batteries.

- 1** Raise the latch on the remote's back cover to remove it.
- 2** Insert the two supplied batteries, carefully notice the "+" and "-" markings on the batteries and remote control. To avoid a short circuit, insert "-" end first.
- 3** Snap the cover back into place.

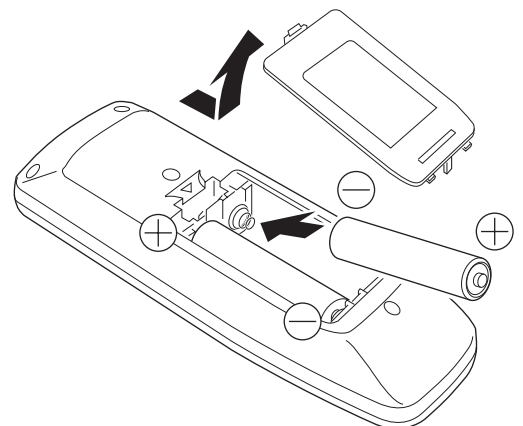

- If the remote control acts erratically, replace the batteries. Typical battery life is usually about six months to one year.
- We recommend that you use the supplied batteries initially and replace them as soon as operation becomes erratic.  
The supplied batteries are for testing, not regular use.





---

## POWER

- Press the Power button (  ) on the TV front panel. The Power lamp will light red.
- If the TV will not be turned on even if you press the POWER button, the TV is in the stand-by mode. Press the POWER button on the remote control to turn on the TV.
- To turn the power off, press the POWER button on the remote control. The Power lamp will light red.
- The ON-TIMER lamp will light when the On/Off Timer is set, even when the TV power is off.
- When you do not use the television for a long period of time, turn the power off by pressing the Power button (  ) on the TV front panel. The Power lamp will go out.
- There are two methods to turn the power on after turning it off by pressing the POWER button on the remote control or by using the On/Off Timer function:
  - 1) Press the POWER button on the remote control.
  - 2) Press the CHANNEL – button or CHANNEL + button on the TV front panel.
- When the On-Timer function is set, the On-Timer lamp will light. Even if you turn the power off by pressing the POWER button on the remote control, if the On-Timer function is active the On-Timer lamp stays lit. See page 13 to set On/Off Timer.

---

## ADJUSTING VOLUME

- 1** Press the VOLUME button on the front panel or remote control. The volume level bar will appear.



- 2** Press the MUTING button to instantly turn the volume off to zero. To restore the volume to your previous level, simply press the MUTING button again.

---

## CHANGING CHANNELS

- 1** 10 key direct access.

Press the numbers on the remote's 10 key pad. For single-digit channel numbers press 0 then the number. For channels above 100, press the 100+ button plus the 2-digit number.

- 2** Channel –/+.

Press the – CHANNEL , button, it will scan the channels in order.

- NOTE: After you operate the Auto Tuner Setup (page 10), all of the blank or empty, channels will be removed from scanning so that there is no noise or channel snow when you scan, only active channels.*

- 3** Return.

Press the release of the RETURN + button to return to the previous channel. First, select a channel (game #1). Then, select another channel (game #2) with the 10 key pad and push the RETURN+ button to flip directly back and forth.

- 4** Return +.

Press and hold down the RETURN + button for three seconds. The message, "RETURN CHANNEL PROGRAMMED !" will appear and you can scan as you wish with the – CHANNEL + button. Press RETURN + button again and you will go back to the Return+ channel you programmed.

To cancel the Return + channel, press and hold down the RETURN + button for another three seconds and the message, "RETURN CHANNEL CANCELED !" appears.

- Pressing any number key or turning the TV off will also cancel a Return+ channel.



# GETTING STARTED

## SETUP TOUR

When the TV is first turned on it enters the SETUP TOUR mode, and the JVC logo is displayed. Follow the instructions on the on-screen display to perform the SETUP TOUR.

☐ In case of resetting that the reason for such as removal, you can set the SETUP TOUR function on the menu. For details, see page 10.

### 1 Press the Main power button on the TV.

The POWER lamp or POWER/ON TIMER lamp lights. After the JVC logo has been displayed, the TV automatically switches to the language setting mode.

### 2 Press the MENU ◀▶ buttons to select the on-screen language.

### 3 Press the MENU ▼ button.

The SET CLOCK screen will appear.

- ◀▶ To set the hour (AM/PM)
- ▼ To move to minutes
- ◀▶ To set the minutes
- ▼ To move to START CLOCK when done with settings

### 4 Press the MENU ◀▶ buttons to start the clock.

The TUNER MODE screen will appear.

- ◀▶ To choose CABLE or AIR
- ▼ To move to NEXT

The AUTO PROGRAMMING function will start and the indicator blinks.

☐ To stop the AUTO PROGRAMMING function, press the MENU ◀▶ buttons.

When all the TV channels that can be received on your TV have been preset, the display goes out and the AUTO PROGRAMMING function operation is completed.

**JVC**

SETUP TOUR

SETUP TOUR  
LANGUAGE  
ENGLISH

▼ NEXT

SETUP TOUR  
SET CLOCK  
-- : --

START CLOCK

SETUP TOUR  
TUNER MODE  
CABLE

▼ NEXT

SETUP TOUR  
NOW PROGRAMMING !  
▶▶ ◻ ▶▶  
01

SETUP TOUR  
THANK YOU!  
SET IS NOW COMPLETE





## USING THIS GUIDE:

Throughout this guide there are certain symbols we use as shorthand to show you what to do. When you see them, keep these factors in mind:

- ▲ ▼ Up and down arrows mean press the MENU UP or MENU DOWN buttons. Pressing the up or down buttons allows you to:
  - Move vertically in the main menu screen
  - Move through a submenu, or
  - Move to the next letter, number, or other choice in a submenu, or
  - Back up to correct an error
- ◀ ▶ Left and right arrows mean press the MENU LEFT or MENU RIGHT button to:
  - Select the highlighted item, or
  - Select the options in a submenu



The “Press Button” means you should press that button on the remote control

- ☐ Important information, or a note, about a feature follows a cube like this one.

*SMALL CAPITAL LETTERS are used when we refer to buttons ... this is important because some menu functions have the same name.*

## THE ONSCREEN MENUS:

**To bring up the onscreen menu,** press any of the 4-way cursor control (MENU) buttons on the remote, and the menu will appear on the screen. The item that appears yellow is the selected item. When you use the menu buttons, the Picture Settings menu will appear first. However, since Initial Setup is so important, this guide begins here.

## INITIAL SETUP ITEMS

AUTO TUNER SETUP			
NOISE MUTING		ON	OFF
BACKGROUND		BLACK	CLEAR
CLOSED CAPTION			
LANGUAGE		POR	SPA
SETUP TOUR			ENG
SELECT	BY ▲▼		EXIT BY
OPERATE	BY ◀▶		EXIT

## PICTURE SETTINGS

TINT	=====  =====
COLOR	=====  =====
PICTURE	=====  =====
BRIGHT	=====  =====
DETAIL	=====  =====
SELECT	BY ▲▼
OPERATE	BY ◀▶
	EXIT BY
	EXIT

## SOUND SETTINGS

(AV-21YT11/AV-20NT11/AV-14FT11 Only)

BASS	=====  =====
TREBLE	=====  =====
BALANCE	=====  =====
MTS	STEREO    SAP    MONO
	ON AIR ↗
SELECT	BY ▲▼
OPERATE	BY ◀▶
	EXIT BY
	EXIT

## GENERAL ITEMS

SET CLOCK			
ON/OFF TIMER			
CHANNEL SUMMARY			
SET LOCK CODE			
CHILD LOCK		ON	OFF
SELECT	BY ▲▼		EXIT BY
OPERATE	BY ◀▶		EXIT

- ☐ If you use the Menu button on the TV's front panel, an additional menu indicating the current channel and the TV/Video status will appear before the picture settings screen.
- ☐ In the Picture screens menu, the "Tint" option only appears if the TV signal is NTSC.



# INITIAL SETUP

## AUTO TUNER SETUP

During Auto Tuner Setup, the TV will automatically scan through all available channels and memorize the active ones so that when you scan, you do not pick up weak or noisy channels.

▲▼ To AUTO TUNER SETUP

◀▶ To operate



◀▶ To choose CABLE or AIR

▲▼ To move to START

◀▶ To start Auto Tuner Setup



The Programming takes approximately 1 to 2 minutes



**Note:** Noise Muting will not work while Auto Tuner Setup is working.

## BACKGROUND

Turn the background color of the on-screens to black or clear.

▲▼ To BACKGROUND

◀▶ To operate

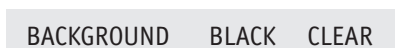

Exit when finished

## CLOSED CAPTION

If they are included in a program, you can view closed captions or text information.

▲▼ To CLOSED CAPTION

◀▶ To operate and select a caption or text channel

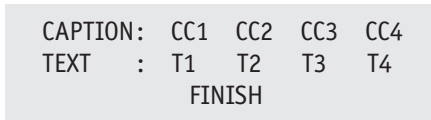

▲▼ To FINISH

◀▶ To save settings

EXIT when finished

**Note:** Captions are usually found on CC1 and text on T1. The other caption and text channels are workable but are for future purposes.

**Note:** See page 16 for complete details on how to access captioning with the CLOSED CAPTION button.

## LANGUAGE

Choose from English, Portuguese, or Spanish on-screen menus and displays.

▲▼ To LANGUAGE

◀▶ To activate



Exit when finished

## NOISE MUTING

Eliminates noise from channels that are not broadcasting or are too weak.

▲▼ To NOISE MUTING

◀▶ To turn ON/OFF

Exit when finished

**Note:** Noise Muting will not work when you operate Auto Tuner Setup or Channel Summary.

### NOTE:

During Initial Setup, the TV will be programmed to only receive active channels. Once the channels are activated by the Auto Tuner Setup they will be included in Scan. Some weak channels may be included or omitted during this procedure. You can add or delete any channels for scanning in the Channel Summary, page 14.

# PICTURE SETTINGS



## NOTE:

To exit the Picture Settings menu, press the Exit button at any time.

## TINT (NTSC ONLY)

Tint allows you to adjust the levels of red and green in the picture. The tint option appears only when the TV color system is NTSC.

- ▲▼ To TINT
  - ▶ To accentuate green
  - ◀ To accentuate red
- ▲▼ To move to the next or previous

## COLOR

Color allows you to adjust both the vividness and subtlety of the color.

- ▲▼ To COLOR
  - ▶ To make colors more vivid
  - ◀ To subdue colors
- ▲▼ To move to the next or previous

## PICTURE

Picture allows you to adjust the range between black and white in the picture.

- ▲▼ To PICTURE
  - ▶ To increase contrast
  - ◀ To decrease contrast
- ▲▼ To move to the next or previous

## BRIGHT

Adjust the degree of light and dark in the picture.

- ▲▼ To BRIGHT
  - ▶ To lighten the picture
  - ◀ To darken the picture
- ▲▼ To move to the next or previous

## DETAIL

Detail allows you to adjust the level of detail within the picture.

- ▲▼ To DETAIL
  - ▶ To make the picture sharper
  - ◀ To make the picture smoother
- ▲▼ To move to the next or previous



# SOUND SETTINGS

## BASS

The Bass level adjustment feature allows you to increase or decrease the level of lower frequencies in the TV's sound.

- ▲▼ To BASS
  - ▶ To emphasize bass
  - ◀ To reduce bass
- ▲▼ To move to next

## TREBLE

The Treble level adjustment feature allows you to increase or decrease the level of higher frequencies in the TV's sound.

- ▲▼ To TREBLE
  - ▶ To increase treble
  - ◀ To decrease treble
- ▲▼ To move to next

## BALANCE

The Balance adjustment feature allows you to center the TV's sound to your needs.

- ▲▼ To BALANCE
  - ▶ To shift the speaker balance to the right
  - ◀ To shift the speaker balance to the left
- ▲▼ To move to next

## MTS (Multi-Channel Television Sound)

MTS technology gives you a choice among stereo, mono, and Second Audio Programs (SAP).

- ▲▼ To MTS



- ◀▶ Select the mode

(The ON AIR arrow tells you if the current signal contains Stereo or SAP)

- Note:** Keep the TV in STEREO mode to get the fullest sound quality.
- Note:** SAP will allow you to hear an alternative soundtrack, if available.
- Note:** Choose MONO to reduce excess noise in a program or channel.

### NOTES:

#### STEREO MODEL ONLY!!

Bass, Treble, Balance, and MTS are available on:

- AV-21YT11
- AV-20NT11
- AV-14FT11

MTS has no effect on normal sound broadcasts.

### Some Sound Advice

You can tell if a program is broadcast in stereo by the position of the ON AIR arrow in the MTS menu. Unfortunately, it is common for some cable companies to squash the transmission of stereo programs to mono because they only have mono equipment. If connected to a cable system, the sound is at the mercy of that cable company — if they broadcast in mono, you receive mono sound regardless of the original stereo programming.

Fortunately, most programs that are broadcast in stereo are aired on the major television networks. If you connect your TV to an antenna instead of cable, and set the tuner mode in the Auto Tuner Setup to "Air" instead of "Cable," you will be able to pick up stereo broadcasts in stereo.

## SET CLOCK

The Clock is the heart of all timer functions. You must set the clock before any timer functions will work.

▲▼ To SET CLOCK

◀▶ To operate

```

TIME          12:34   AM
                START CLOCK
    
```

◀▶ To set the hour (AM/PM)

▼ To move to minutes

◀▶ To set the minutes

▼ To move to START CLOCK when done with settings

◀▶ To start the clock

THANK YOU !!

If you want to synchronize the TV clock with another clock or time signal, press Left or Right Menu arrow at the appropriate time, and the clock will start.

**Note:** If the TV is unplugged or you experience a power outage, you must reset the clock in order for any of your timer functions to work.

## CLOCK SET MESSAGE:

If you do not set the clock but attempt to use a timer function anyway, you will get the following message:

```

PLEASE SET CLOCK FIRST !!
TIME          --:--  --
                START CLOCK
    
```

## ON/OFF TIMER

Use the On/Off Timer as an alarm to wake up, as a program reminder, or as a decoy when you're out of the house.

▲▼ To ON/OFF TIMER

◀▶ To operate

```

ON TIME          12 : 00  AM
OFF TIME         1 : 00  AM
CHANNEL          07
MODE             ONCE  EVERYDAY
ON/OFF TIMER     YES NO
                FINISH
    
```

◀▶ To set the hour (AM/PM) you want the TV to turn on

▼ To move to minutes

◀▶ To set the minutes

▼ To set ON TIME and to move to OFF TIME (set time for TV to turn off)

▼ To move to CHANNEL

◀▶ To select channel

▼ To move to MODE

◀▶ Choose ONCE or EVERYDAY

▼ To ON/OFF TIMER

◀▶ Choose YES for on, NO for off

▼ To FINISH

◀▶ To save settings

THANK YOU !!

**Note:** In order for ON/OFF Timer to work, the clock must be set. After a power interruption it will be cancelled.

**Note:** ON/OFF Timer cannot be set to locked or guarded channels.



# GENERAL ITEMS

## CHANNEL SUMMARY



You can add or delete channels from the channel scanning. You can also lock out any "unauthorized" viewers from one or up to all 181 channels.

- ▲ ▼ To CHANNEL SUMMARY
- ◀ ▶ To operate

## ADD

You can manually set channels to scan that were too weak to be picked up during Auto Tuner Setup. (If you have not performed the Auto Tuner Setup described on page 10, do so now.) Conversely, if a channel was too weak to receive a good picture but was picked up anyway, delete it by removing the X.

 CHANNEL +/- to select the channel

CH	ADD		:	CH	ADD	
01	X	-	:	06	X	-
02	X		:	07	-	-
03	-	-	:	08	-	-
04	X	-	:	09	X	-
05	X	-	:	10	X	-

- ▲ ▼ To the ADD column
- ◀ ▶ To include or delete from scan
-  Exit when finished





**Note:** Channels set to scan will be marked with an X.

**Note:** Some cable systems experience interference from radio frequencies on Cable Channel 95. If you like, you can delete this channel from scanning by removing the X.

## CHANNEL GUARD - LOCK

- ▲ ▼ To CHANNEL SUMMARY
- ◀ ▶ To operate
- ▲ ▼ To the Lock column

 The access code zero (0) to lock or unlock that channel

CH	ADD		:	CH	ADD	
01	X	-	:	06	X	-
02	X	-	:	07	-	
03	X	-	:	08	-	
04	X	-	:	09	X	-
05	X	-	:	10	X	-

Use the Channel +/- button to go to any other channel you want to lock

 Exit when finished

## CHANNEL GUARD MESSAGE:

This message appears when a viewer attempts to watch a guarded channel:

THIS CHANNEL IS LOCKED BY  
CHANNEL GUARD.  
PLEASE ENTER LOCK CODE BY  
10 KEY PAD TO UNLOCK IT.  
NO. ---

To watch a channel you have locked, enter the lock code using the 10 key pad.

If the wrong lock code is entered, this message will flash on the screen:

INVALID LOCK CODE !

## NOTES:

There are two sections in Channel Summary.

To move up and down a column (e.g. from channel to channel) use the Channel +/- button.

To move from item to item (e.g. from channel number to add to lock) use the arrow up/down keys.

Noise Muting will not work while you operate the Channel Summary.

## SET LOCK CODE

The Lock Code locks and unlocks Channel Guard. Write this three digit number down and keep it where would-be viewers will not look for it!

▲▼ To SET LOCK CODE

◀▶ To operate

*The padlock icon appears*



 Zero (the access code is zero)

LOCK CODE	000
FINISH	

▲▼ To the first number place

◀▶ To choose the number

▲▼ To move to the next place

*Continue to follow these directions for all three numbers*

▲▼ To FINISH

◀▶ To save settings and exit

**Note:** If you forget the Lock Code you can set another one this same way.

**Note:** After a power interruption you must reset the lock code.

## CHILD LOCK

You can disable the front control buttons of the TV.

When this function is set to ON, the TV can be operated using only the remote control.

▲▼ To CHILD LOCK

◀▶ To turn ON/OFF

 Exit when finished

**Note:** The Child Lock is canceled when you turn the TV's main power off.



# BUTTON FUNCTIONS

## DISPLAY

The Display screen shows the current status of timers and inputs.



DISPLAY

07	
NOW	12:20 PM
SLEEP TIMER	OFF
ON/OFF TIMER	EVERYDAY
ON TIME	7:00 PM
OFF TIME	10:00 PM

- The channel or AV input (Channel 07)
- Current time (12:20 PM)
- Sleep Timer status minutes remaining (Off)
- On/Off Timer status (Everyday, on at 7:00 PM, off at 10:00 PM)
- Each press of the Display button changes the display mode:

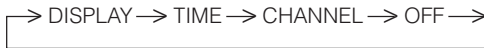

## CLOSED CAPTION

View the closed captions or text when included in a program.



CLOSED CAPTION



- Note:** To change caption or text channels see page 10.
- Note:** To access a captioning option or to turn one off, allow the display to remain on screen until it disappears. In a few seconds the captions will start.
- Note:** CC2, CC3, CC4, T2, T3, and T4 are functional, however, they are for future purposes.
- Note:** If a large black box covers 80% of your screen, the Text Mode is probably set. Press CLOSED CAPTION to turn it off.

## VIDEO STATUS

The Video Status button lets you select the settings when you play a game, watch a movie, or want to reset to factory settings.

- “STANDARD” resets the picture settings to factory standard levels.
- “CINEMA” for a film-like look to video.
- “GAME” enhances video graphics.



VIDEO STATUS

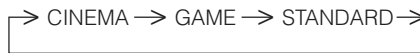

## SLEEP TIMER

Sleep Timer turns off the TV for you in case you fall asleep. Program it to work in intervals of 15 minutes up to 180 minutes.



SLEEP TIMER

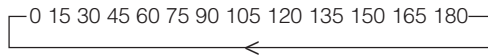

## SLEEP TIMER MESSAGE:

20 seconds prior to the automatic shut-off, this message will appear:

GOOD NIGHT !!  
 PUSH SLEEP TIMER BUTTON  
 TO EXTEND.

You then have 20 seconds to press the SLEEP TIMER button to delay turn off for another 15 minutes.

## HYPER SURROUND

AV-21YT11/AV-20NT11/AV-14FT11 ONLY.

Creates a deep, 3-dimensional sound effect by channeling the sound through the TV's front firing speakers.



HYPER SURROUND

### NOTE:

Please note that if the clock, SleepTimer, or On/Off Timer are not set, the initial Display screen will state “Clock Not Set,” “Sleep Timer Off,” and “On/Off Timer Off,” respectively.



## NUMBER BUTTONS

### 10 KEY PAD

Press two of the number buttons to move to single and double digit channels.

#### To move to Channel 7:

 0 (zero)

 7 (seven)

### 100 + BUTTON

The 100+ button accesses all channels above Channel 99.

To move to Channel 124:

 100+

 2 (two)

 4 (four)

### MUTING

The **MUTING** button turns the sound off completely when you press it.

 **MUTING**

*The sound will turn off completely.*

**Note:** To return the original volume press the **MUTING** button again.

### MENU BUTTONS

The **MENU** buttons allow you to control the options located in the menu screens. A complete discussion on these buttons and on the menu system is located on page 9.

## TV / VIDEO

TV/Video selects the input mode.

 TV/VIDEO

AV-21YN11/AV-20NN11/AV-14FN11

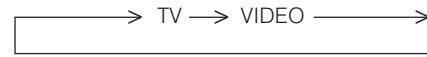

AV-21YT11/AV-20NT11/AV-14FT11



**VIDEO-1:** The video signal input to the input terminal on the rear panel is selected.

**VIDEO-2:** The video signal input to the input terminal on the front panel is selected.

## COLOR SYSTEM

The color system is automatically selected, but if the picture not clear or no color appears, select the color system manually.

 COLOR SYSTEM

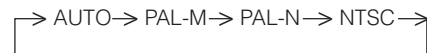



# BUTTON FUNCTIONS

## RETURN+

There are two kinds of Return.

**Return+** — Set a “Return Channel” to return to after scanning with CHANNEL -/+. —/+.



RETURN+ and hold for 3 seconds

RETURN CHANNEL  
PROGRAMMED !

Scan with CHANNEL -/+



RETURN+

**Note:** To cancel a Return channel, press and hold the RETURN+ button for another 3 seconds until “Return Channel Canceled !” appears.

**Return** — Return to the last channel viewed after moving to another channel via the 10 key pad.



RETURN+

Move to another channel with the 10 key pad.



RETURN+

## PICTURE BOOSTER

When the picture is unclear because the reception level of the TV signal is low, activating the Picture Booster improves the picture clarity in some situations.



PICTURE BOOSTER



**OFF:** The Picture Booster off.

**HIGH:** The Picture Booster is functioning at maximum.

**LOW:** The Picture Booster is functioning at minimum.

**Note:** If the picture becomes abnormal when you set the Picture Booster to HIGH, then set it to LOW or OFF.

<b>PROBLEMS</b>		<b>CHECK</b>
There is no power	<ul style="list-style-type: none"> <li>• See if the power cord became unplugged.</li> <li>• Perhaps you have experienced a blown circuit breaker or fuse or a power outage.</li> </ul>	
There is no picture or no sound	<ul style="list-style-type: none"> <li>• The antenna could be disconnected.</li> <li>• The input mode (TV or Video) could not be set properly, refer to page 17.</li> <li>• The tuner mode (in the Auto Tuner Setup) could be set improperly, refer to page 10.</li> <li>• The station may be having difficulties, check to see if other channels are operating normally.</li> </ul>	
Remote control is not operating or operating properly	<ul style="list-style-type: none"> <li>• Check that the batteries are still working and properly installed.</li> <li>• Make sure there are no objects blocking a clear path from the remote to the TV.</li> <li>• Maybe you are too far from the TV, you must be within 7m.</li> </ul>	
You cannot select a certain channel	<ul style="list-style-type: none"> <li>• Make sure the channels are programmed. See Channel Summary, page 14.</li> <li>• Perhaps the channel is locked, select it with the 10 key pad and follow instructions, on page 14.</li> </ul>	
The power turns off by itself	<ul style="list-style-type: none"> <li>• Perhaps the On/Off Timer is set, press the POWER button, check page 13.</li> <li>• The power was interrupted or the power cord unplugged. Reset the clock, check page 13.</li> <li>• The Sleep Timer may be set.</li> </ul>	
The clock is wrong	<ul style="list-style-type: none"> <li>• The power was interrupted and the clock not reset. Reset the clock, check page 13.</li> </ul>	
On Timer lamp is blinking	<ul style="list-style-type: none"> <li>• There is a problem with the TV. Unplug the set and call for service.</li> </ul>	
<b>PICTURE</b>		<b>CHECK</b>
The picture color quality is poor	<ul style="list-style-type: none"> <li>• Tint and color may be improperly adjusted. Check page 11.</li> <li>• Video Status mode may be set to an inappropriate setting. Check page 16.</li> </ul>	
There are lines across the picture	<ul style="list-style-type: none"> <li>• There could be interference from another energy consuming appliance, such as a computer, another TV or VCR. Move any other such appliances farther away from the TV.</li> </ul>	
The picture is spotted	<ul style="list-style-type: none"> <li>• There could be interference from a running high wattage appliance such as a hair-dryer, vacuum cleaner, or neon sign. You will have to move the antenna away from the source of the interference or change it to a coaxial cable which is less prone to interference.</li> </ul>	
Double picture (Ghosts)	<ul style="list-style-type: none"> <li>• A building or airplane can reflect the original signal producing a second, delayed one. Adjust the antenna position.</li> </ul>	
Snowy picture/ Image noise	<ul style="list-style-type: none"> <li>• The antenna may be damaged, disconnected or turned. Check the antenna connection, page 3 and page 4. If it is damaged, you will have to replace it.</li> </ul>	
Screen is 80% black	<ul style="list-style-type: none"> <li>• Closed Caption Text Mode in on. Press the CLOSED CAPTION button until you select Off.</li> </ul>	
<b>SOUND</b>		<b>CHECK</b>
Bilingual or stereo programs can not be heard	<ul style="list-style-type: none"> <li>• Make sure the MTS mode is properly set. Refer to page 12 for details on setting MTS Modes.</li> </ul>	
<b>NOT A PROBLEM</b>		<b>DON'T WORRY ABOUT THIS, IT'S NORMAL</b>
Static electricity	<ul style="list-style-type: none"> <li>• It is normal to feel a surge of static electricity if you brush over or touch the screen.</li> </ul>	
You hear occasional crackling sounds	<ul style="list-style-type: none"> <li>• It is normal for the TV to emit crackling sounds when turned on or off. Unless the sound or picture become abnormal, this is fine.</li> </ul>	



# S P E C I F I C A T I O N S

MODEL	AV-21YT11/AV-20NT11/AV-14FT11	AV-21YN11/AV-20NN11/AV-14FN11
Color systems	PAL, NTSC	PAL, NTSC
TV RF systems	M, N	M, N
Channels	VHF 2 to 13, VHF 14 to 69 Sub Mid, Super, Hyper and Ultra bands	VHF 2 to 13, VHF 14 to 69 Sub Mid, Super, Hyper and Ultra bands
Sound-multiplex system	MTSC (Multi-Channel Television Sound)	_____
Audio output (Rated power output)	3 W + 3 W	3 W (monaural)
Speakers	AV-21YT11: (6 cm × 12 cm) oval × 2 (stereo)	AV-21YN11: (6 cm × 12 cm) oval × 2 (monaural)
	AV-20NT11: (5 cm × 12 cm) oval × 2 (stereo)	AV-20NN11: (5 cm × 12 cm) oval × 2 (monaural)
	AV-14FT11: (5 cm × 9 cm) oval × 2 (stereo)	AV-14FN11: (5 cm × 9 cm) oval × 2 (monaural)
External input/output	VIDEO-1/VIDEO-2: VIDEO input (RCA) AUDIO L/R input (RCA) VIDEO output (RCA) AUDIO L/R output (RCA)	VIDEO input (RCA) AUDIO input (RCA) VIDEO output (RCA) AUDIO output (RCA)
Headphone jack	Stereo mini jack (dia. 3.5 mm, sound is stereo)	Stereo mini jack (dia. 3.5 mm, sound is monaural)
Accessories	Remote control unit; RM-C373GY × 1 AA/R6/UM-3 dry cell battery × 2 Indoor antenna × 1 Matching adaptor × 1	Remote control unit; RM-C372GY × 1 AA/R6/UM-3 dry cell battery × 2 Indoor antenna × 1 Matching adaptor × 1

***Design and specifications subject to change without notice.***

**JVC**  
VICTOR COMPANY OF JAPAN, LIMITED