

Hitachi Color TV

Instruction manual

C1459FN
C2057FN
C2059FS
C2159FS

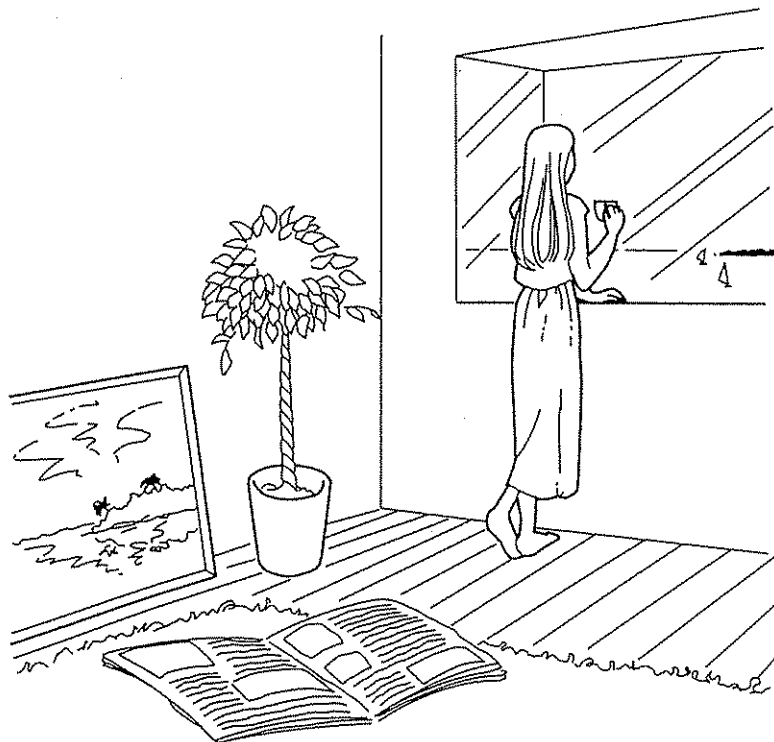

HITACHI

TPA4004601

Thank you for purchasing this Hitachi high performance color TV which was designed and manufactured using Hitachi's advanced technology and engineering.

Please read this instruction manual carefully before using the TV, and also read attached "Important points for proper use". Keep it carefully for future reference.

CONTENTS

CONNECTIONS	4
Connect the aerial using the aerial adaptor	4
Connection with other equipment	5
FUNCTIONAL PARTS	6
Front panel of the TV set	6
Rear panel of the TV set	6
On the remote control unit	7
TURNING THE POWER ON/OFF	8
LANGUAGE SELECTION	8
MENU SCREENS	9
CHANNEL SELECTION	10
Selection using direct buttons	10
Selection using the programme up/down buttons	10
VOLUME CONTROL	11
INPUT SELECTION	11
CHANNEL SETTING	12
Auto-presetting using the front panel buttons	12
Auto-presetting	12
Manual search presetting	13
Fine tuning	14
Presetting using the front panel buttons	14
Presetting in the video mode	15
CHANNEL SKIP	16
SYSTEM SELECTION	17
SOUND SYS (Sound system)	17
COLOR SYS (Color system)	18
FUNCTION	20
PICTURE ADJUSTMENT	21
SOUND ADJUSTMENT	22
TIMER FUNCTIONS	23
Setting the timer	23
Setting of AUTO OFF	23
Checking the remaining time	24

OTHER FUNCTIONS	24
Mute	24
Recall	25
SURROUND Sound	25
A2/NICAM/SOUND MULTIPLEX	26
SPECIFICATIONS	27

CONNECTIONS

Connect the aerial using the aerial adaptor

When using a coaxial cable to connect the aerial, connect the coaxial cable to the aerial adaptor which comes together with the TV set.

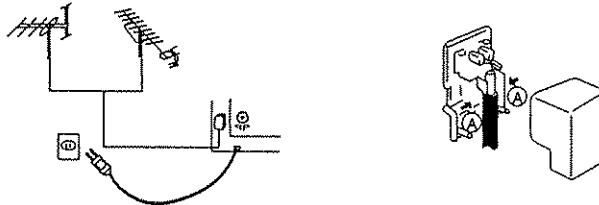

NOTE

- When installing the coaxial cable, clamp section A using pliers.
- The aerial adaptor is designed for use exclusively with a 75ohm coaxial cable. It cannot be used with a 300ohm feeder wire. For safety, install an external aerial conforming to AS 1417.1 (in Australia only).

Precautions when connecting the aerial

- Whenever possible, use a coaxial cable which is not affected by interference to connect the aerial. Avoid using a parallel feeder wire as interference may occur, causing reception to be unstable and stripe noise to appear on the screen.
- Avoid using indoor aerial as this may be affected by interference.
- Keep the power cord and connection cords as far away from the aerial wire as possible.

Connection with other equipment

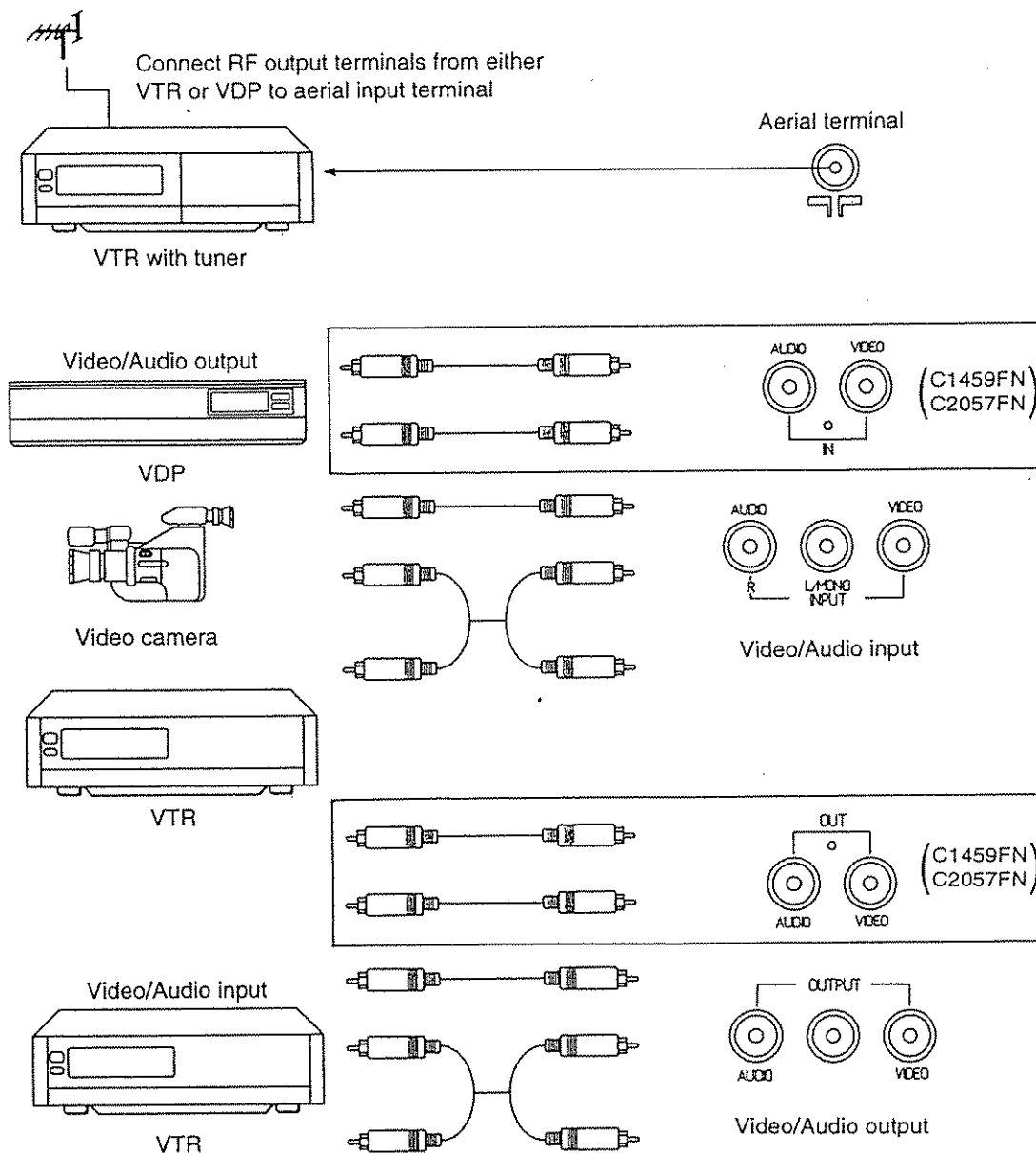

NOTE

- If the output signal of the VTR/VDP is monoaural, connect it to the L/MONO input terminal.

Precautions when connecting to other equipment

- When using external equipment with this TV set, please read the instruction manual for the external equipment.
- Turn off all power supplies to the devices before connecting.
- Always ensure that the input and output terminals are correctly connected, or it may cause trouble.

FUNCTIONAL PARTS

Front panel of the TV set

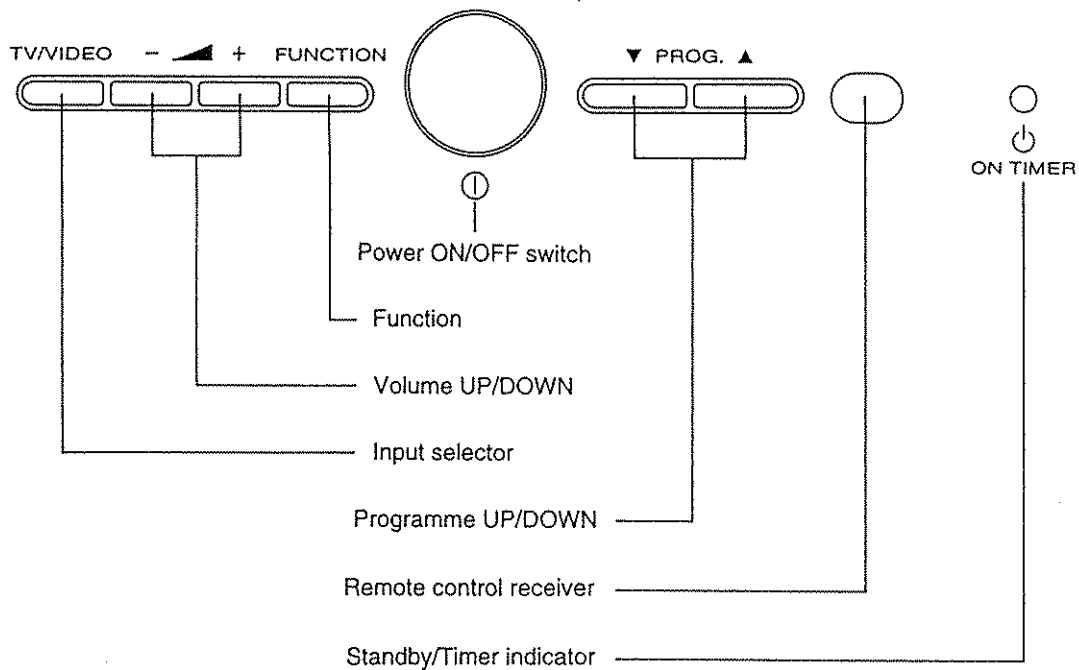

Rear panel of the TV set

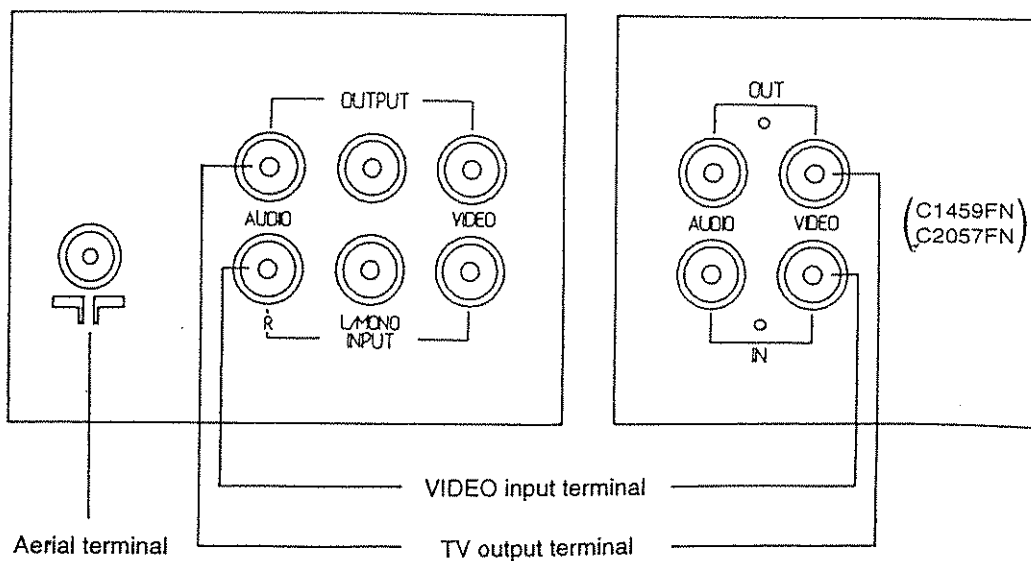

On the remote control unit

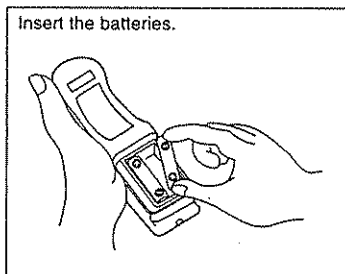
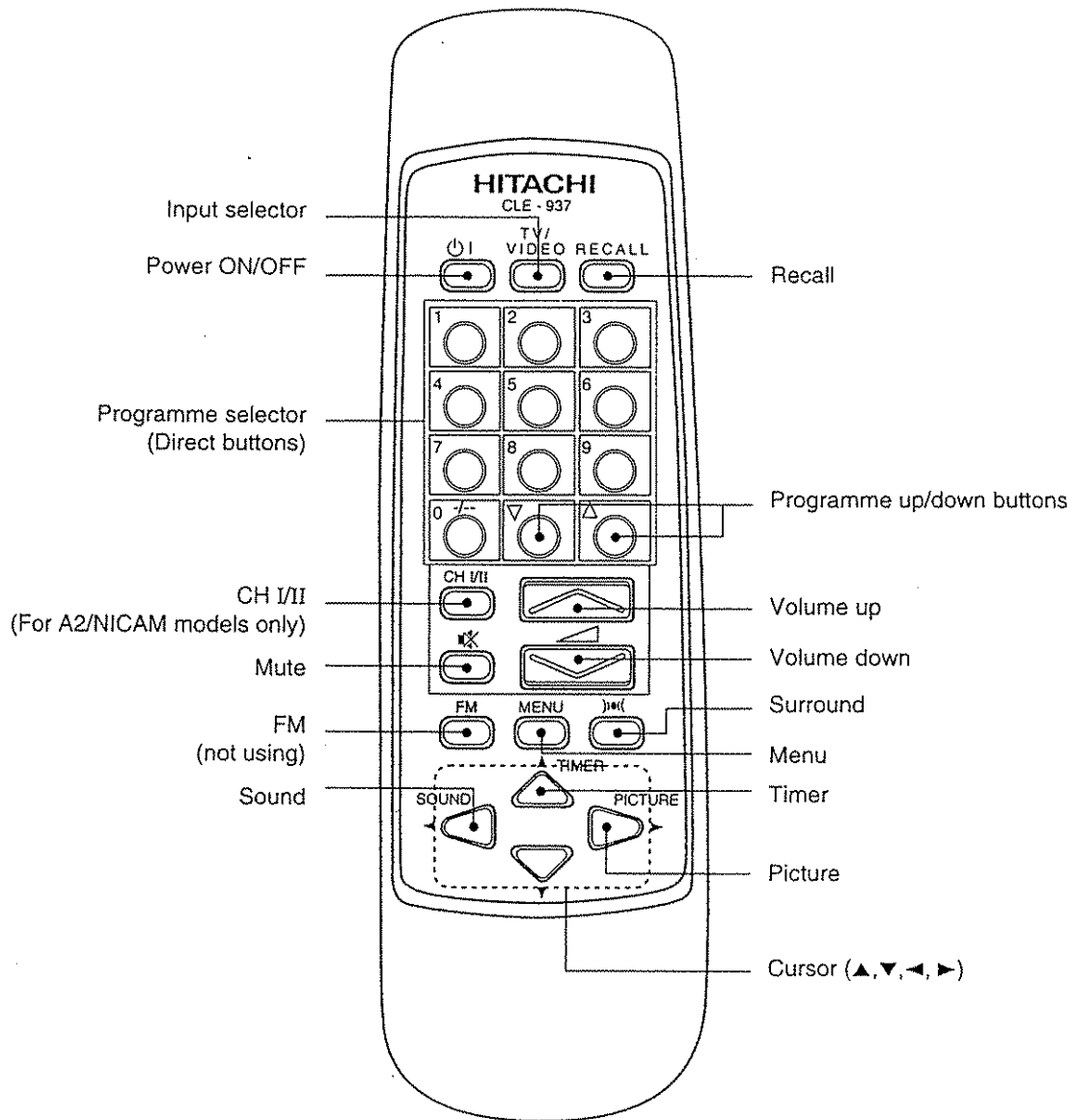

When replacing the batteries, replace both batteries at the same time.



TURNING THE POWER ON/OFF

To turn the power ON

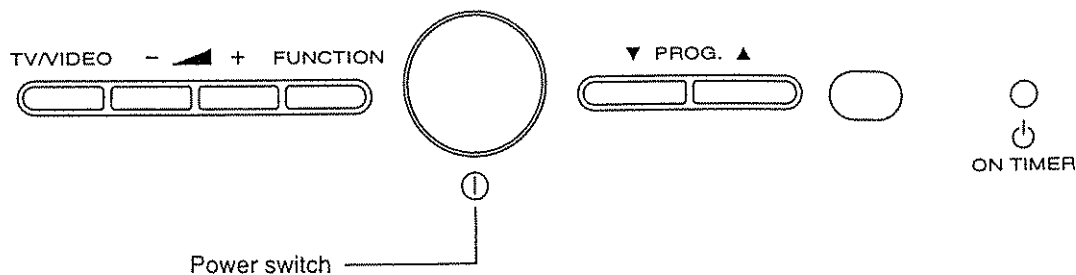
Press the power switch on the TV set.
When TV set is ON, LED turns OFF.



When the stand-by indicator is on

You can turn the TV set on or to STANDBY using the  button on the remote control unit. The picture usually takes a few seconds before appearing. You can also use the  of the TV set to turn it on. At standby mode, the LED is ON.

To turn the power OFF

Press the power switch on the TV set. The power indicator will be turned off.
You cannot turn off the power by using the remote control unit.



Caution

- If you are not going to use this set for a long time, turn the set off using the power switch on the TV set and disconnect the power plug from the power outlet.

LANGUAGE SELECTION

The language display can be selected among English, Chinese, Malay or Russian by using the front panel buttons.

Before selection, please make sure the power switch is at "OFF" position.

- 1 Turn the power on.
- 2 Press the  button to display the LANGUAGE mode.
- 3 Use the  button to select the required language.
- 4 Press the  button to return to the normal picture mode.

* LANGUAGE *
ENGLISH
中文
MELAYU
РУССКИЙ

CHANNEL SELECTION

Selection using direct buttons

With this model, you can receive local stations by simply selecting the channel number of the desired station using the direct buttons on the remote control unit.

Each time the **0/--** button is pressed, the display changes between "--" and "--" and AV00 on the top right hand corner of the screen.

"--" is for 2 digit channel selection and "--" is for 1 digit channel selection.

- 1 Press the **0/--** button to choose between 1 or 2 digit channel selection.
- 2 Select the channel number of the desired station by pressing the direct buttons on the remote control unit.

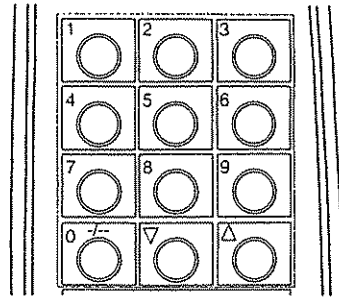

Example of 2 digit channel selection

Channel	Buttons on the remote control unit
5	0 , 5
10	1 , 0
29	2 , 9

Example of 1 digit channel selection

Channel	Buttons on the remote control unit
5	5
8	8

Selection using the Programme up/down buttons

Press the programme up/down buttons to cycle through the channels.

To make channel selection faster, set the CHANNEL SKIP to [YES] for all channels that are not used. This will ensure that all channels not used for broadcast in your area will be skipped. Please refer to page 16 for the setting of CHANNEL SKIP.

Example

If the CHANNEL SKIP has been set to [YES] for all channels besides CH5, CH10, CH29, CH32, CH38 and CH45 which are used for broadcasting, pressing the programme up/down buttons will cycle through the channels as shown below.

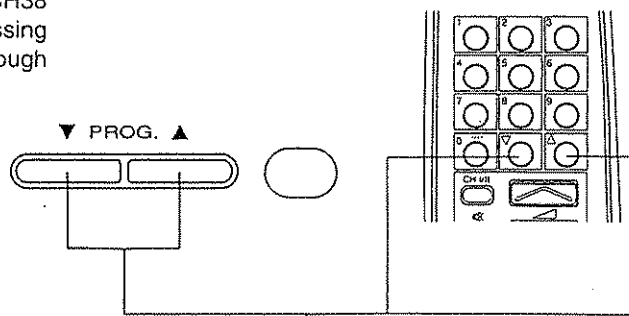
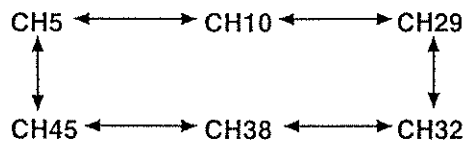

programme up/down buttons

VOLUME CONTROL

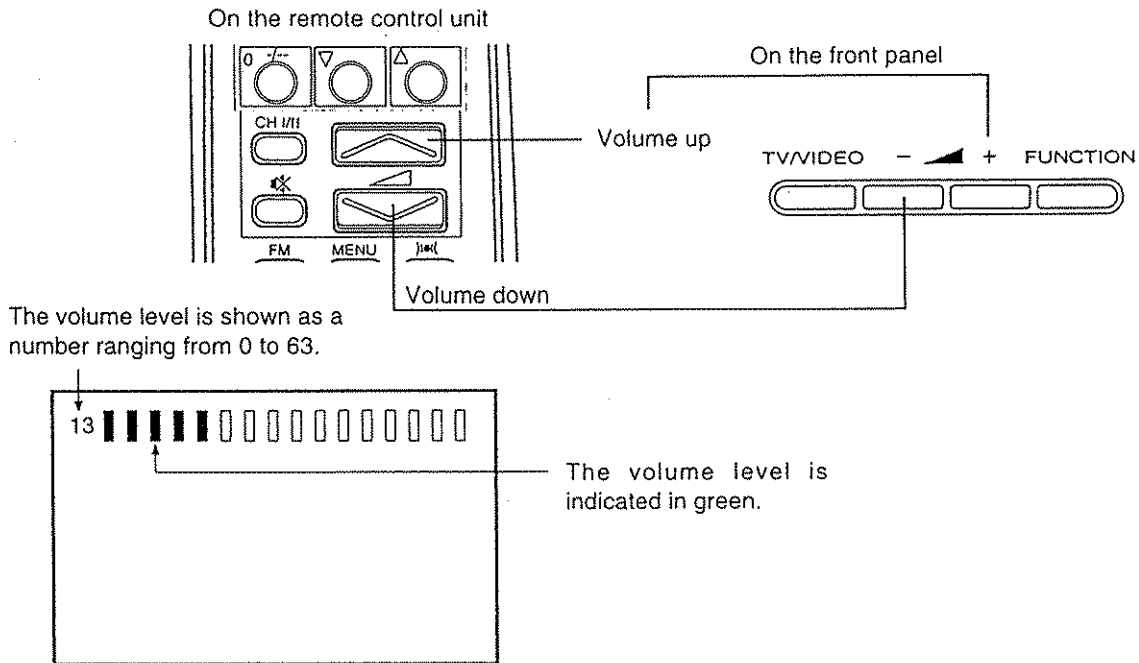

INPUT SELECTION

To select the input mode, press the **TV/VIDEO** button on the remote control unit or the button at the front panel of the set.

Each time you press the **TV/VIDEO** button, the input mode and the screen display changes, cycling through the following modes -

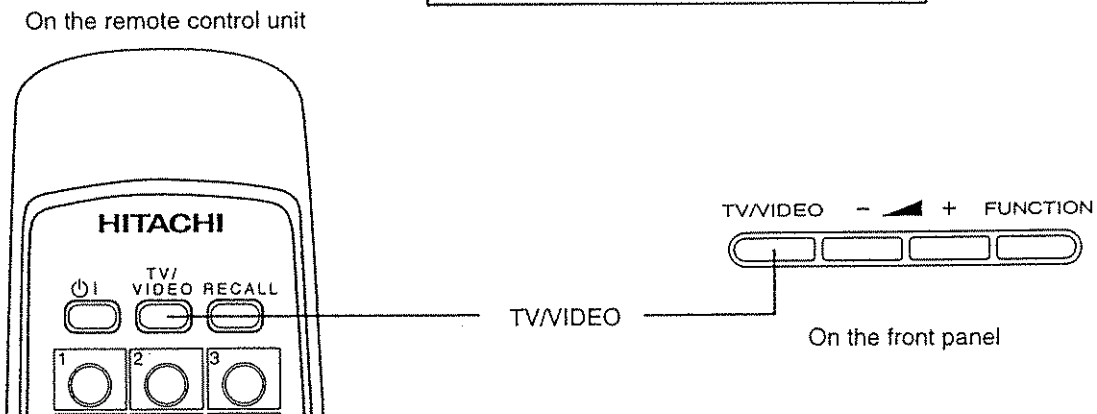
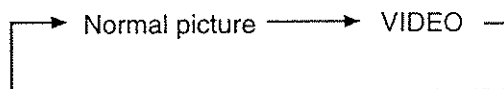

To return to the normal TV picture from the video mode, press the **PROG.▲/PROG.▼** buttons or the direct programme selector buttons on the remote control unit.

CHANNEL SETTING

Auto-presetting using the front panel buttons

- 1 Turn on the set. Press **FUNCTION** button 3 times followed by **TV/VIDEO** button 3 times to scroll downwards to SETUP.
- 2 Press **▶+** button to go into SETUP menu.
- 3 Then, press **▶+** button to start AUTO preset.

```
*SETUP* 1
AUTO
MANUAL
FINE

PRESS ▼▲ AND ◀▶
```

Precaution

- If you change the presetting after the channel setting has been completed, perform AUTO or MANUAL presetting again. Otherwise, the required channel may not be received.

Auto-presetting

- 1 Select SETUP from the MENU screen.
- 2 Select AUTO using the **▲/▼** cursor buttons and press the **◀▶** cursor buttons.
- 3 The channels being broadcast will be preset automatically.

```
*SETUP* 1
AUTO
MANUAL
FINE

PRESS ▼▲ AND ◀▶
```

```
VHF:L 1
■■■■■■■■.....
```

NOTE

- If some required stations cannot be preset in the auto presetting operation, select and preset the required stations in the required positions by manual search presetting, as described in the next item.
- After presetting is done, the screen returns automatically to the normal picture. Depending on the broadcast system, the SOUND SYS and/or COLOR SYS may have to be set (see pages 17-19).
- The SKIP function is automatically set to [YES] for those channels which are not broadcasting. These channels will be skipped when the **PROG.▲/PROG.▼** button is pressed (see page 16).

Manual search presetting

- 1 Select SETUP from the MENU screen.

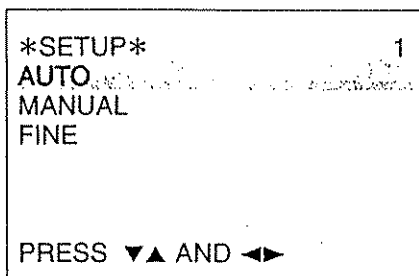

- 2 Select MANUAL using the ▲/▼ cursor buttons and press the ◀▶ cursor buttons.

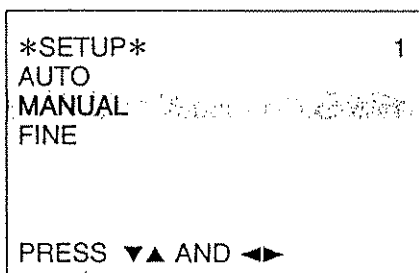

- 3 Select TUNE using the ▲/▼ cursor buttons and press ◀▶ cursor buttons.

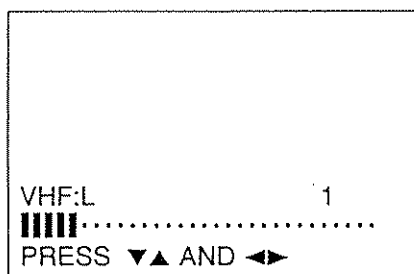
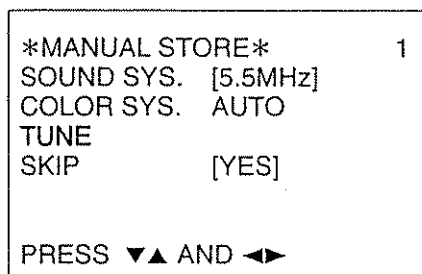

- 4 Search for the desired broadcast station using the ◀▶ cursor buttons. When a channel is found, the searching stops. Note that the band can be changed by pressing ▲/▼ cursor buttons.
- 5 Check the picture and sound. Depending on the broadcast system, you may have to set the SOUND SYS and/or the COLOR SYS. If so, press **MENU** button to return to previous screen.
- 6 Select the SOUND SYS or COLOR SYS using the ▲/▼ cursor buttons. Then set it using the ◀▶ cursor buttons.
- 7 To set another channel, change the position using the 0 ~ 9, or ▲/▼ buttons. Repeat step 4.
- 8 After completing the presetting, press the **MENU** button until picture returns to normal.

Fine tuning

If the signal is unsatisfactory, you can fine tune the signal reception.

- 1 Select SETUP from the MENU screen.

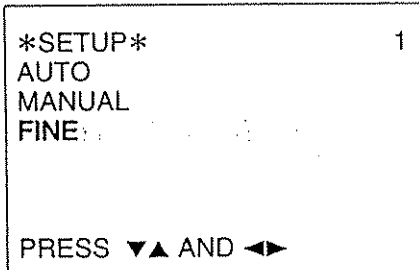

- 2 Select FINE using the ▲/▼ cursor buttons and press ▶/◀ cursor buttons.

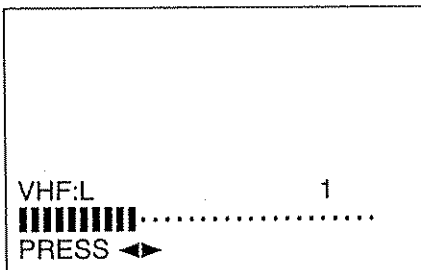

- 3 Use ▶/◀ cursor buttons to fine tune the signal until clear picture and sound is obtained.
- 4 After completing the fine tuning, press the [MENU] button until picture returns to normal.

Presetting using the front panel buttons

- 1 Press the [FUNCTION] button once to display the main MENU.
- 2 Select SETUP menu by using [TV/VIDEO] button.

Remote control button	Front panel button
MENU	FUNCTION
Cursor ▼	TV/VIDEO
Cursor ◀	- ◀
Cursor ▶	▶ +

- 3 If user is in menu screen depicted in Fig. 1, use the - ◀ or ▶ + button to go into tuning screen (see Fig. 2).
- 4 Press - ◀ or ▶ + to start tuning.
- 5 Press the [FUNCTION] button until picture returns to normal.

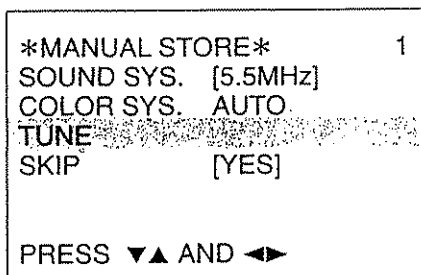

Fig. 1

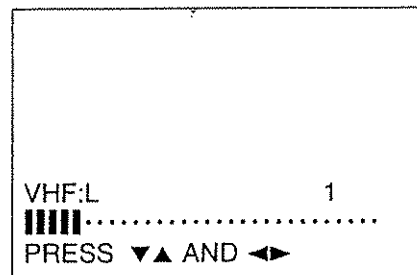
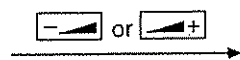

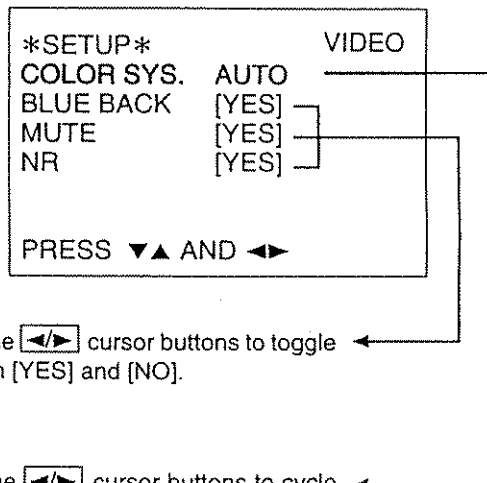



Fig. 2

Presetting in the video mode

- 1 Select SETUP from the MENU screen.
- 2 Select the desired item (COLOR SYS, BLUE BACK, MUTE, NR) using the  cursor buttons.
- 3 Adjust the setting of the selected item using the  cursor buttons.



Press the  cursor buttons to toggle between [YES] and [NO].

Press the  cursor buttons to cycle the COLOR SYS through the 5 different modes:

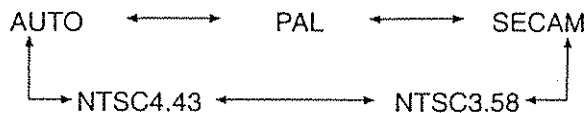



- 4 Press the **MENU** button until picture returns to normal.

NOTE



- When using the TV set as an audio amplifier, please set MUTE to [NO] and BLUE BACK to [YES] position.

CHANNEL SKIP

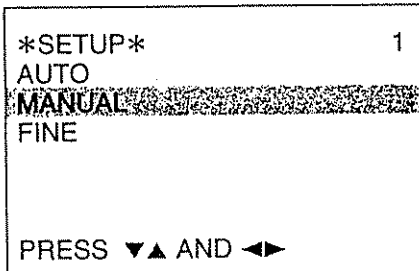

Auto-presetting always set SKIP to [YES]. When SKIP is set to [YES], non-broadcasting channels are skipped to allow quicker selection of the desired channel.

- 1 Select SETUP from the MENU screen.
- 2 Select MANUAL using the  cursor buttons and press the  cursor buttons.

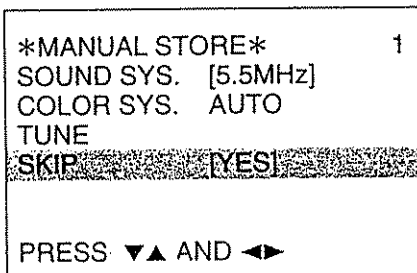

- 3 Select SKIP using  cursor buttons and press  cursor buttons to set to [YES] or [NO].



- 4 Go to the next channel by using the  or  buttons and press  cursor buttons to set to [YES] or [NO].
- 5 Repeat step 4 until SKIP option is set for all required stations.
- 6 Press the **MENU** button until picture returns to normal.



NOTE

- AV00 is a channel for VTR or TV game. The channel skip for this channel is left as [NO] after auto-presetting. If you do not require this channel, set SKIP for this channel to [YES].



SYSTEM SELECTION

SOUND SYS (Sound system)

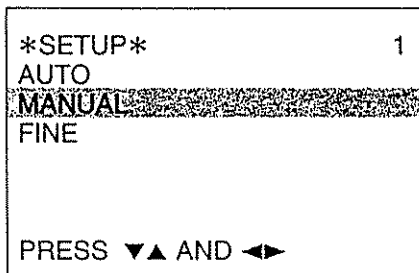

Different broadcast methods and sound systems may result in noisy signals, no sound or no colors in the picture received. To overcome this problem, you have to set the SOUND SYS from the SETUP screen.

- 1 Select SETUP from the MENU screen.
- 2 Select MANUAL using the  cursor buttons and press  cursor buttons.



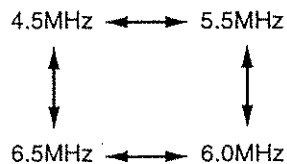
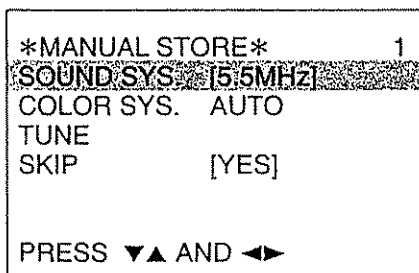

- 3 Select SOUND SYS using  cursor buttons.
- 4 Use the  cursor buttons to cycle the SOUND SYS through the 4 different settings:





- 5 To set the sound system of another channel, change the channel using the  or  buttons on the remote control unit. Repeat step 4.
- 6 After all settings are completed, press  button until picture returns to normal.

COLOR SYS (Color system)

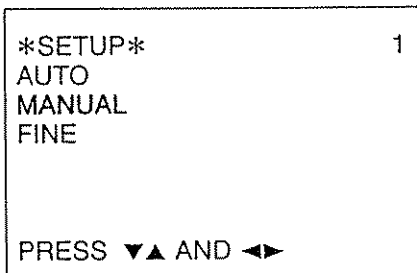

This TV set is equipped with an automatic selection function which enables it to receive different kinds of broadcast signals. However, cases might arise where the system selection operates incorrectly due to poor signal or when a special signal (NTSC3.58-5.5MHz sound, interference due to NICAM signals etc) is received. You can rectify the problem by setting the COLOR SYS.

- 1 Select SETUP from the MENU screen.
- 2 Select MANUAL using the  cursor buttons and press the  cursor buttons.

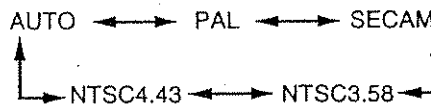
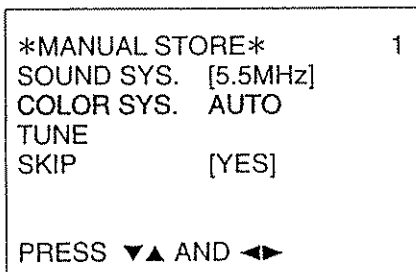

- 3 Select COLOR SYS using  cursor buttons.
- 4 Use the  cursor buttons to cycle the COLOR SYS through the 5 different settings. Select the system which gives a normal picture.



- 5 To set the color system of another channel, change the channel using the  or  buttons on the remote control unit. Repeat step 4
- 6 After all settings are completed, press the  button until picture returns to normal.

NOTE

- The COLOR SYS is set to AUTO before shipping.
 - The mode set by forced selection for each position is stored in memory.
-

System		Mode	
		Color	Sound
Normal broadcasting system		AUTO	---
Color discrimination		PAL, SECAM, NTSC3.58 (select suitable system)	---
Sound noise generated by NICAM signal	B.G NICAM	AUTO	5.5MHz
	I NICAM	AUTO	6.0MHz
NTSC (3.58MHz color) with 5.5/6.0/6.5MHz sound signal received		NTSC3.58 or AUTO	(5.5MHz, 6.5MHz) (6.0MHz)
NTSC4.43		NTSC4.43	(5.5MHz, 6.5MHz) (6.0MHz)

FUNCTION

There are three options under the FUNCTION MENU, namely NR (Noise Reduction) function, BLUE BACK function and AVL (Auto Volume Levelling) function. They can be accessed as shown below:

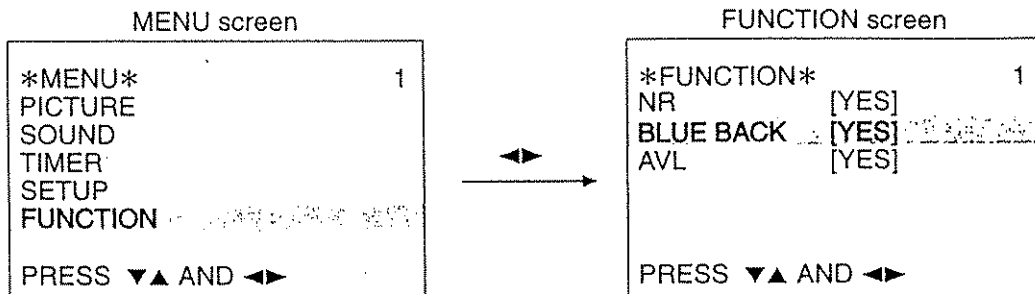

NR function

NR (Noise Reduction) function when set to [YES] will reduce noise in the picture due to weak signal condition.

- 1 Select FUNCTION from the MENU screen.
- 2 Choose NR by pressing **▲/▼** cursor buttons and then press **◀/▶** cursor buttons to toggle between [YES] and [NO].
- 3 Once the required NR mode is selected, press **MENU** button twice to return to normal picture.

BLUE BACK function

This TV set has a BLUE BACK function which when set to [YES] will make the background blue and mask picture noise.

- 1 Select FUNCTION from the MENU screen.
- 2 Choose BLUE BACK by pressing **▲/▼** cursor buttons and then press **◀/▶** cursor buttons to toggle between [YES] and [NO].
- 3 Once the required BLUE BACK mode is selected, press **MENU** button twice to return to normal picture.

AVL function

AVL (Auto Volume Levelling) function when set to [YES], automatically adjusts the sound level output at the speakers to an optimum value when broadcast signals fluctuate in strength.



- 1 Select FUNCTION from the MENU screen.
- 2 Choose AVL by pressing **▲/▼** cursor buttons and then press **◀/▶** cursor buttons to toggle between [YES] and [NO].
- 3 Once the required AVL mode is selected, press **MENU** button twice to return to normal picture.

NOTE

- If AVL is on, maximum sound level is reduced.
- AVL operation can not operate in video mode.



PICTURE ADJUSTMENT

The contrast, brightness, color level, sharpness and tint can be adjusted. Note that tint adjustment is only available in the NTSC mode.

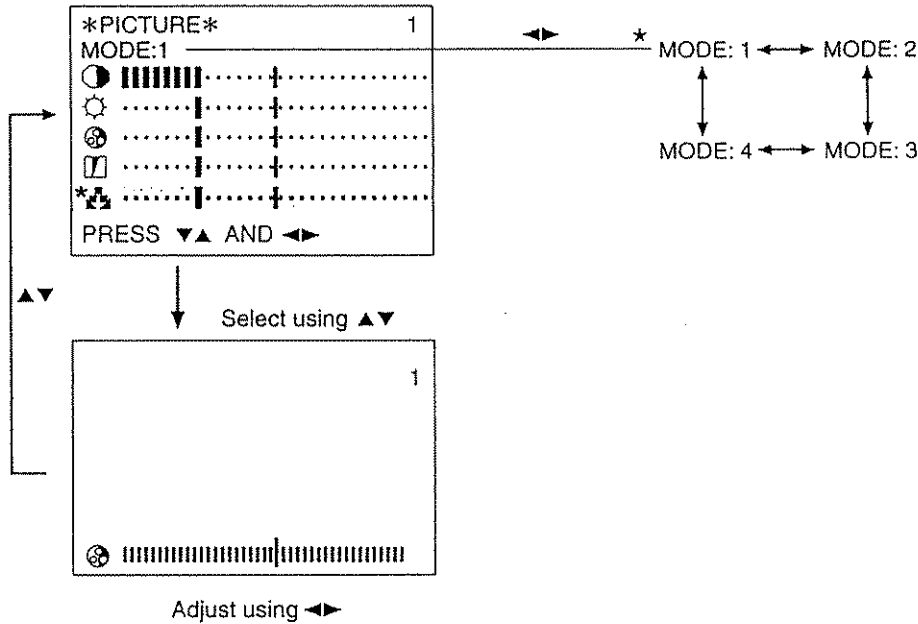
- 1 Select PICTURE from the MENU screen.
- 2 Select the desired item (contrast, brightness, color level, sharpness or tint) using the  cursor buttons and press the  buttons.



*NOTE : Automatically appears in NTSC mode.

- 3 Use the  cursor buttons to select the setting and adjust using the  cursor buttons.
- 4 Press **MENU** button to return to the PICTURE screen. (TV screen automatically returns to PICTURE screen after 2 seconds if the user does not adjust the setting.)
- 5 Repeat steps 2 to 4 until all necessary adjustments are completed.
- 6 Press the **MENU** button until normal picture is seen.

★ Up to 4 settings of the picture adjustment mode can be stored in memory.

Example:

MODE:1	Normal picture.
MODE:2	Preset powerful picture mode with color and contrast increased.
MODE:3	Preset soft picture mode for night time by decreasing brightness.
MODE:4	Preset any other picture mode as desired.

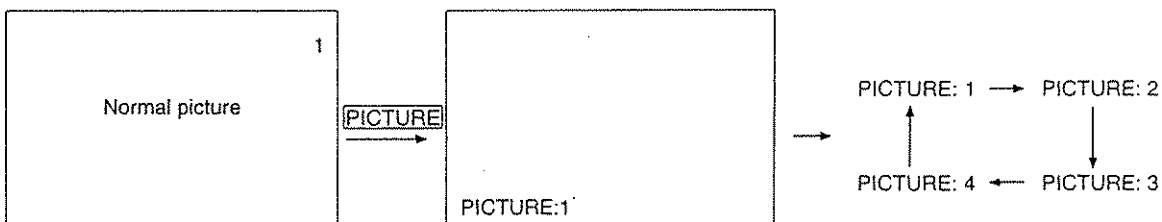

How to call up memory.

Each time the **PICTURE** button is pressed, picture mode is changed in the following sequence:





SOUND ADJUSTMENT

The bass, treble and balance can be adjusted. (Except C1459FN, C2057FN)

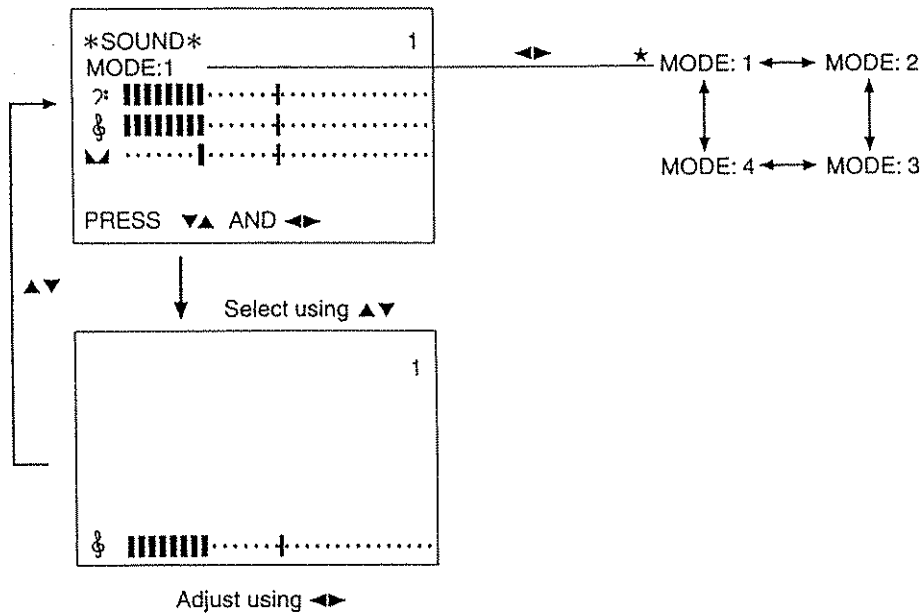
- 1 Select SOUND from the MENU screen.
- 2 Select the desired item (bass, treble, balance) using the  cursor buttons and press the  cursor buttons.



- 3 Use the  cursor buttons to select the setting and adjust using the  cursor buttons.
- 4 Press the **MENU** button to return to the SOUND screen. (TV screen automatically returns to SOUND screen after 2 seconds if the user does not adjust the setting.)
- 5 Repeat steps 2 to 4 until all necessary adjustments are completed.
- 6 Press the **MENU** button twice to return to the normal picture.

★ Up to 4 settings of the sound adjustment mode can be stored in memory.

Example:

MODE: 1	Normal sound.
MODE: 2	Preset powerful sound mode with bass and treble increased.
MODE: 3	Preset soft sound mode for night time by decreasing bass and treble.
MODE: 4	Preset any other sound mode as desired.

How to call up memory.

Each time the **SOUND** button is pressed, sound mode is changed in the following sequence:

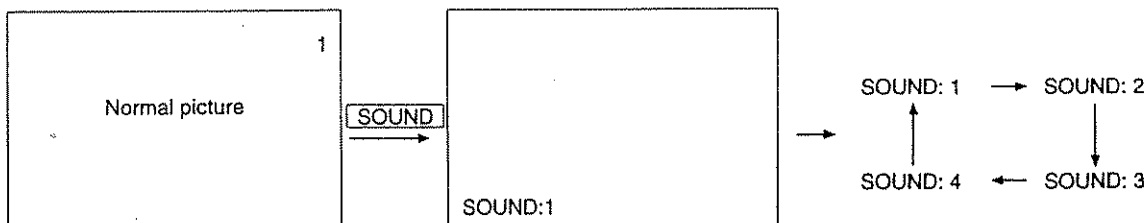

TIMER FUNCTIONS

Timer functions

This TV set has various timer functions, namely AUTO OFF, ALARM, ON TIMER and OFF TIMER.

ON TIMER turns on the TV set to a desired channel after the set time has elapsed.





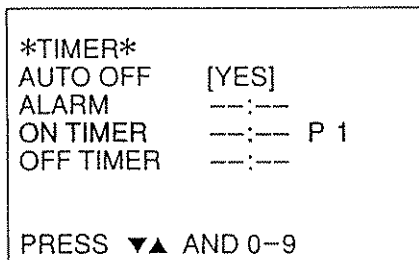

OFF TIMER turns off the TV set after the set time has elapsed.

ALARM sets off a beeper (provided the TV is on) after the set time has elapsed.

Setting the timer

- 1 Select TIMER from the MENU screen.
- 2 Select the desired item (AUTO OFF, ALARM, ON TIMER, OFF TIMER) using the  cursor buttons.





- 3 Use the  cursor buttons to toggle the AUTO OFF option between [YES] and [NO].
- 4 Use  ~  buttons to enter the time for ALARM, ON TIMER and OFF TIMER. To change timer setting, simply re-enter the 4 digits again.
- 5 Use  cursor button to select the ON TIMER channel. Set desired ON TIMER channel by pressing  cursor buttons.
- 6 Press the  button until picture returns to normal.

NOTE

- If ON timer is set, the LED on the front of the TV set will blink. (10 seconds on, 1 second off).
- The ON timer will only be effective if the power of the TV set is turned off using the remote control unit. If the main power is turned off, the power cord is disconnected or a power failure occurs, the timer has to be set again.
- The time entered for ALARM, ON and OFF TIMER refers to the time from setting till activation and not the real time.

Setting of AUTO OFF

When AUTO OFF is set to [YES], the power is automatically turned off about 10 minutes after broadcasting stops i.e. no signal is received.

- 1 Select TIMER from the MENU screen.
- 2 Select AUTO OFF using the  cursor buttons.
- 3 Use the  cursor buttons to toggle between [YES] and [NO].
- 4 Press the  button until picture returns to normal.

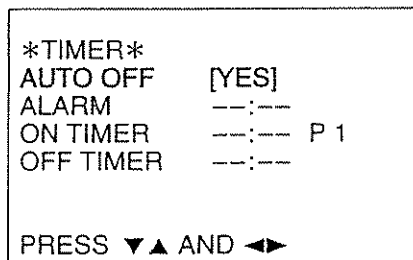

Checking the remaining time

- 1 Press **TIMER** button on remote control unit.



ON TIMER 02:00

- 2 TV set will display the OFF, ON and ALARM timer in the following sequence:

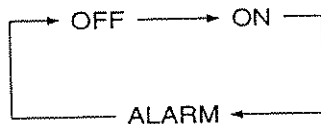



- 3 ALARM, ON and OFF TIMER can also be set by directly using the **0**~**9** buttons of the remote control unit in the above screen.
- 4 To cancel the TIMER function, enter "00:00".

OTHER FUNCTIONS

Mute

You can turn off the sound temporarily using the  button. This is especially convenient for answering the phone or receiving visitors.

Press the  button to mute the sound, changing the volume display to magenta. To restore the sound volume, press the  button again. Pressing the volume up key also restores the sound.

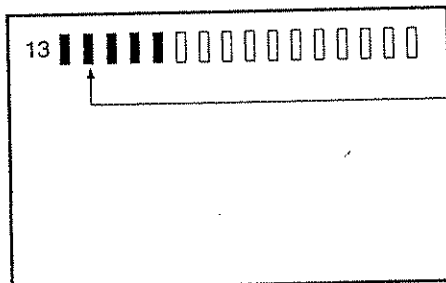

When muted, the volume display color changed to magenta.

Recall

The RECALL function displays the channel number on the screen if a broadcast programme is being viewed. For a video programme, the video input source and TV channel number is displayed.

Press the **RECALL** button to display the TV channel number.

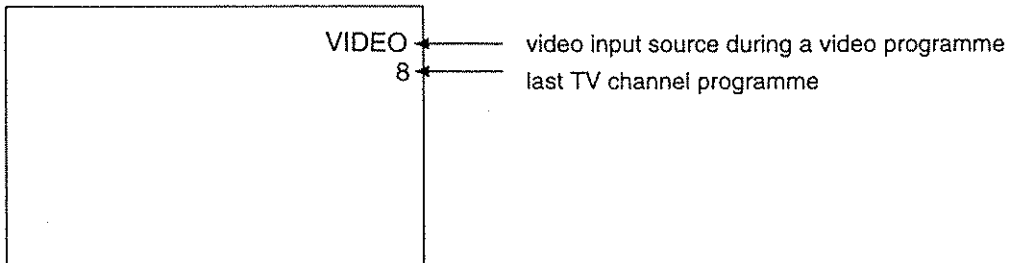
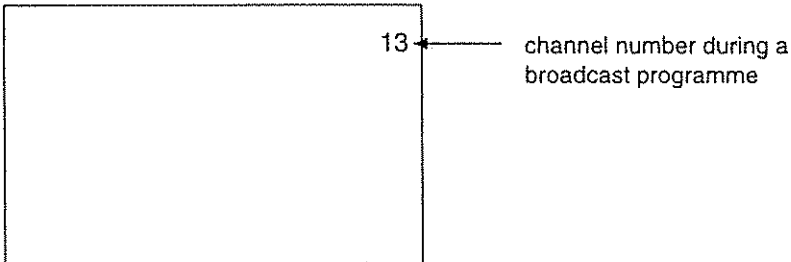

SURROUND Sound (Except C1459FN, C2057FN)

The SURROUND function provides a surround sound effect which gives a sensation of presence, very much like bringing an orchestra right into your home.

Each time you press the **⏮** button, the setting cycles through the following modes:

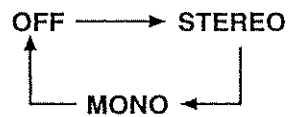

A2 / NICAM / SOUND MULTIPLEX

(With A2/NICAM model only.)

Press the **[CH I/II]** button, to hear the sound multiplex broadcast.

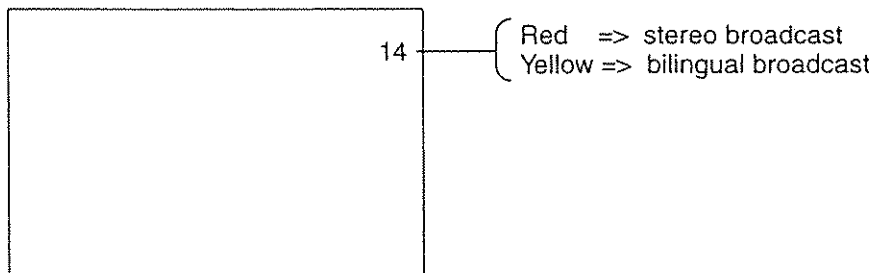

NOTE

- This function is useful only for NICAM and sound multiplex signals. Otherwise, pressing the button will have no effect. Consult your dealer for details.
- If reception is not clear for any channel, press the **[CH I/II]** button until "FM" is seen on the top right corner of the screen.
- For bilingual broadcasts, pressing **[CH I/II]** button can select between the two broadcast signals.

SPECIFICATIONS

		C1459FN	C2057FN C2059FS	C2159FS	
Reception system	625-lines B.G./D.K/H PAL B.G./D.K/K' SECAM NTSC 50 525-lines M/NTSC NTSC 3.58-5.5/6.0/6.5 NTSC 4.43-5.5/6.0/6.5 PAL 60	Aerial input	75 Ohm unbalanced type		
		Color picture tube	A 34 JXV 70 X	A 48 LGS 10X	A 51 KPX 10X
		Speaker	5 cm x 9 cm	5 cm x 9 cm 5 cm x 9 cm(x 2)	5 cm x 9 cm(x 2)
		Sound Output (Max)	5W	5W 5W + 5W	5W + 5W
Channel coverage Frequency range (44 MHz-404 MHz 407 MHz-868 MHz)	CCIR : E2-12, E21-69, S01-3, S1-10, S11-20, S21-41 OIRT : R1-12, R21-69 JAPAN : J1-12, J13-62 U.S.A. : US2-13, J-W, US14-69 Hong Kong, U.K. : UK21-69 China : C1-12, C13-57	Power supply	AC 110-240V 50/60Hz (USABLE AC 100-264V)		
		Power consumption	70W	86W	89W
		Weight (kg)	9.6	18.6	21.0
		Dimensions W x H x D (cm)	37.8 x 35.0 x 37.9	51.2 x 45.3 x 47.7	51.2 x 45.3 x 47.7

* Specifications are subject to change without notice to improve performance.

IMPORTANT POINTS FOR PROPER USE

AERIAL

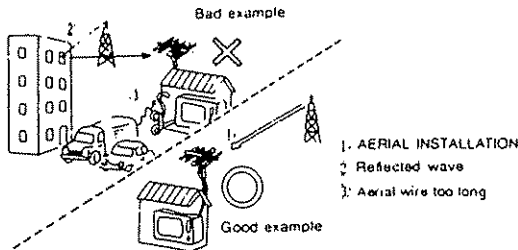

■ When selecting an aerial

- The aerial is very important if you are to enjoy a beautiful colour picture from your colour TV set. Choose an aerial with sensitivity and directivity suitable for the signal condition in your area.
- Be sure to use an aerial exclusively for UHF when receiving UHF broadcasts.

■ When installing the aerial

- Install the aerial away from busy roads, wires and transmission lines, to avoid interference. This will also prevent electric shocks, etc. if the aerial falls down, etc.
- Do not extend or bundle the aerial wire unnecessarily. Fix it firmly to prevent it from swaying. Avoid erecting in a place where there are metal objects. Any of these will have a bad effect on the picture.
- When a coaxial cable is used for the VHF aerial in place of the feeder, it gives an excellent picture without interference and noise.

CHECK YOURSELF BEFORE DECIDING IT IS A MALFUNCTION.

■ If your TV receiver does not operate properly, please check the following points before phoning a service technician.

(1) No picture and no sound

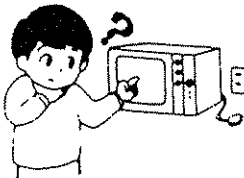

(2) Sound is heard but no picture

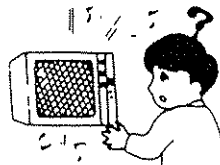

(3) Only noise is heard without picture

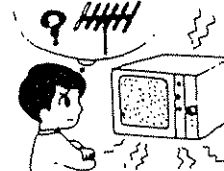

(4) White dots or horizontal stripes

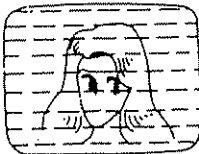

(5) Snow noise



(6) Interference



(7) Ghost



(8) No colour



(9) Bottom of the picture distorted with VTR test signal.

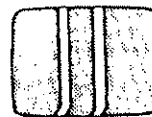

- 1) No picture, no sound: Check that the TV receiver is plugged in and that the mains switch of the set is turned ON.
- 2) Sound OK but no picture: Adjust the fine tuning button carefully. Check whether the brightness control is properly adjusted.
- 3) There is a buzzing sound but no picture. Adjust the line tuning button. Check that the aerial is properly connected to the terminals.
- 4) Ignition: White spots or horizontal streaks may appear on the screen. This is often caused by interference from cars, neon lamps, electrical drills or other electrical appliances. So, the aerial should be installed away from such interference sources.
- 5) Snow: Small dots may appear on the entire screen. Check the aerial connection or the direction of the aerial.
- 6) Radio frequency interference: This interference produces moving ripples or diagonal streaks. This is not caused by the receiver but is caused by interference from other signals or machines using radio frequencies.

- 7) Ghosts (Double images): Change the direction, height or position of the aerial. Reflections from buildings or mountains cause this phenomenon. A highly directional aerial may improve reception.
- 8) No colour picture obtainable during a colour programme: Check that the System switch is set to the correct position. Adjust the Fine tuning button slightly. Adjust the colour control.
- 9) VTR: When the VTR test signal (TSG) is received, the lower side of the test pattern is distorted as shown in the figure. This is not a malfunction and the playback picture is not influenced by it.

NOTICE

- When the power of the set is turned off, a white flash may occur in the CRT screen. This is not a problem and is done to improve the reliability of the CRT.
- When the TV set is moved from place to place or overseas, the colour shading may occur under earth magnetism. At that time, please contact your nearest service shop.