

For illustration only
Dessin à titre d'illustration uniquement
Para ilustración únicamente

**Flat Screen
Television**

**Télévision à
Écran Plat**

**Televisor de
Pantalla Plana**

User Manual-

Model #'s

HTF27R11

Manuel d'utilisation-

Modèles #'s

HTF24R21

Manual del Usuario-

Modelos #'s

HTF20R21

Table Of Contents

	PAGE
Important Safety Instructions	3
INSTALLATION INSTRUCTIONS	6
Unpacking the Television.....	6
Television Location	6
Start Up.....	6
Cable/Antenna Connections.....	7
Connections to Other Equipment	8
Power Interruptions.....	12
FEATURES AND OPERATION	13
TV Features	16
Remote Features.....	17
Menu Features.....	24
Care and Cleaning	30
Troubleshooting	31
Glossary Terms	33
Warranty	37



Warning: To reduce the risk of fire or electric shock, do not expose this appliance to rain or moisture.

CAUTION: TO REDUCE THE RISK OF ELECTRIC SHOCK. DO NOT REMOVE COVER (OR BACK). NO USER-SERVICEABLE PARTS INSIDE. REFER SERVICING TO QUALIFIED SERVICE PERSONNEL.



THIS SYMBOL INDICATES THAT HIGH VOLTAGE IS PRESENT INSIDE. IT IS DANGEROUS TO MAKE ANY KIND OF CONTACT WITH ANY INSIDE PART OF THIS PRODUCT.



THIS SYMBOL INDICATES THAT THERE ARE IMPORTANT OPERATING AND MAINTENANCE INSTRUCTIONS IN THE LITERATURE ACCOMPANYING THE APPLIANCE.

This Important note is located on the rear of the cabinet.

"Note to CATV system Installer: This reminder is provided to call the CATV system installer's attention to section 820-40 of the NEC which provided guidelines for proper grounding and, in particular, specifies that the cable ground shall be connected to the grounding system of the building, as close to the point of cable entry as practical."

IMPORTANT SAFETY INSTRUCTIONS

Read all of the instructions before using this television. When using this television, always exercise basic safety precautions, including the following:

- 1) Save these Instructions — the safety and operating instructions should be retained for future reference.
- 2) All warnings on the television and in the operating instructions should be followed.
- 3) Cleaning — Unplug TV from the wall outlet before cleaning. Do not use liquid cleaners or aerosol cleaners. Use only a damp cloth for cleaning. Exceptions: Some products are designed for uninterrupted service, eg. Cable TV converters, unplugging such accessories may result in loss of authorization codes. In such cases, please follow instructions for unplugging such devices as provided by the accessories manufacturer.
- 4) Attachments — do not use attachments not recommended by the TV manufacturer as they may cause hazards.
- 5) Water and moisture — do not place this TV near water, for example, near a bathtub, wash bowl, kitchen sink, or laundry tub, in a wet basement, or near a swimming pool.
- 6) Accessories — do not place this TV on an unstable cart, stand, tripod, bracket, or table. The TV may fall, causing serious injury to someone, and serious damage to the appliance. Use only with a cart, stand, tripod, bracket, or table recommended by the manufacturer, or sold with the TV. Any mounting of the appliance should follow the manufacturer's instructions and should use a mounting accessory recommended by the manufacturer. An appliance and cart combination should be moved with care. Quick stops, excessive force, and uneven surfaces may cause the appliance and cart combination to overturn.
- 7) Ventilation — Slots and openings in the cabinet and the back or bottom are provided for ventilation and to ensure overheating. These openings must not be blocked in a built in installation such a bookcase or rack unless proper ventilation is provided or the manufacturer instructions have been adhered to.
- 8) POWER Sources — this TV should be operated only from the type of power sources indicated on the electrical nameplate. If you are not sure of the type of power supply to your home, consult your appliance dealer or local power company. For TV's intended to operate from battery power or other source, refer to the operation instructions.
- 9) Grounding or polarization — This TV is equipped with a polarized alternating current line plug (a plug having one blade wider than the other is). This plug will fit into the power outlet only one way. This is a safety feature. If you are

unable to inset the plug fully into the outlet, try reversing the plug. If the plug should still fail to fit, contact your electrician to replace your outlet. Don't defeat the safety purpose of the polarized plug.

- 10) Power cord protection — Power supply cords should be routed so that they are not likely to be walked on or pinched by items placed upon or against them, paying particular attention to cords or plugs, convenience receptacle, and the point where they exit from the appliance.
- 11) Outdoor antenna grounding — If an outside antenna or cable system is grounded so as to provide some protection against voltage surges and built up static charges. Article 810 of the National Electrical Code, ANSI/NFPA No.70, provided information with respect to proper grounding of the mast and supporting structure, grounding of the lead in wire to an antenna discharge unit, size of grounding conductors, location of antenna discharge unit, connection to grounding electrodes, and requirement for the grounding electrode. (Fig. A)

- 12) Lighting precaution — for added protection for this TV receiver during a lighting storm or when it is left unattended for long period of time, unplug it from the wall outlet and disconnect the antenna or cable system. This will prevent damage to the TV due to lighting and power line surges.

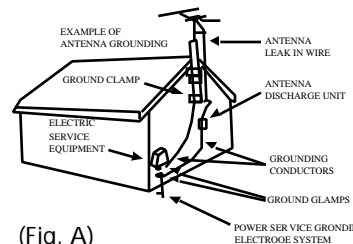

(Fig. A)

- 13) Object and liquid entry — never push objects of any kind into this TV through openings as they may touch dangerous voltage point or short out parts that could result in a fire or electric shock. Avoid spilling liquid of any kind on the TV.
- 14) Servicing — do not attempt to service the TV by yourself, as opening or removing covers may expose you to dangerous voltage or other hazards. Refer all servicing to qualified service personnel.
- 15) Damage Requiring Service — Unplug this TV from the wall outlet and refer servicing to qualified service personnel under the following conditions:
 - a. When the power supply cord or plug is damaged or frayed.
 - b. If liquid has been spilled, or objects have been fallen into the TV.
 - c. If the TV has been exposed to rain or water.
 - d. If the TV does not operate normally by following the operating instructions. Adjust only those controls that are covered by the operating instructions, as improper adjustment of other controls may result in damage and will often require extensive work by a qualified technician to restore the TV to its normal operation.
 - e. If the TV has been dropped or damaged in any way.
 - f. When the TV exhibits a distinct change in performance; this indicates a need for service.

- 16) Replacement parts — when replacement parts are required, be sure the service technician uses replacement parts specified by the manufacturer that have the same characteristics as the original part. Unauthorized substitutions may result in fire, electric shock, injury to persons or other hazards.
- 17) Safety check — Upon completion of any service or repairs to this TV, ask the service technician to perform routine safety checks to determine that the TV is in proper operation condition.
- 18) Heat — This TV product should be situated away from heat sources such as radiators, heat registers, stoves, or other products (including amplifiers) that produce heat.
- 19) Modifications — Any changes or modifications not expressly approved by the Federal Communications Commission on this product could void the user's authority to operate the equipment.
- 20) Carts - An appliance and cart combination should be removed with care. Quick stops, excessive force, and uneven surfaces may cause the appliance and cart combination to overturn.
- 21) Power lines – An outside antenna system should not be located in the vicinity of overhead power lines or other electric light or power circuits, or where it can fall into such power lines or circuits. When installing an outside antenna system, extreme care should be taken to keep from touching such power lines or circuits as contact with them might be fatal.
- 22) Overloading – Do not overload wall outlets and extension cord as this can result in a risk of fire or electric shock.

SAVE THESE INSTRUCTIONS

Thank you for purchasing our Haier product. This easy-to-use manual will guide you in getting the best use of your TV.

Remember to record the model and serial number. They are on a label in back of the TV.

Model number

Serial number

Date of purchase

Staple your receipt to your manual. **You will need it to obtain warranty service.**

Installation Instructions

Unpacking your TV

- Remove all packing materials. This includes the styrofoam and all adhesive tape holding the TV accessories. Inspect and remove any remains of packing, tape or printed materials before using the TV.

Television Location

- The TV must not be placed in sunlight or bright lights, including reflections.
- The TV must be kept away from excessive heat or moisture.
- The TV must be kept away from magnetic equipment such as external speakers, motors and fans.

Start Up

Follow the steps below to get your TV connected and ready for watching.

1. **Plug in your TV.** Plug the cord into the two-prong outlet.

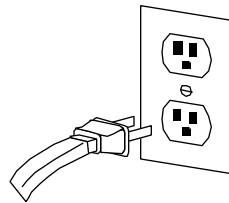

2. **Hook up your TV.** Connect cable or antenna to the provided connection on the back of the TV.

Note: TV antenna or cable wire is not included with the television set. You need to purchase an antenna if you are not going to hook up cable service. If you have a cable service then you must have an existing cable wire that your local cable company had provided at the time of your cable installation that needs to be connected.

3. **Put batteries in the remote control.** Place two AAA size batteries (batteries supplied) into the remote control compartment by matching its + and - end of each battery.

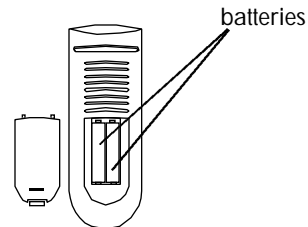

4. **Turn on the TV.** You can turn on the TV by pressing the power button on the TV set or Remote Control.

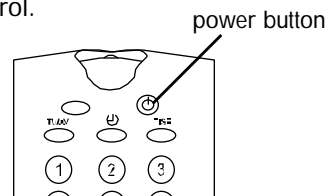

5. **Place all available channels in memory.** By pressing menu button five times, you will see the preset set up. By selecting Auto Program it will set up all available channels into memory. If you want to add or delete channels from memory, you can do it by going into add/delete mode. (refer to preset setup menu on p.29)
6. **Set the Time.** To set the time go to clock set up and set as previously explained. (refer to clock setup menu on p.28)

Cable/Antenna Connections

- In order to get clear reception you must connect antenna or cable to your television set.

Cable Connection:

- Connect your local company's cable to ANT on back of your television.
- Select the cable mode in SET UP menu. (refer to preset menu)

Note: You may need a converter box in order to get a proper reception and for special cable channels broadcasting. You must check with your local cable company for compatibility requirements.

Incoming Cable From Cable Company

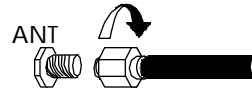

**75 Ohm VHF/UHF
on back of TV**

Antenna Connection:

- You will need an external antenna for proper reception of VHF/UHF channels. An outdoor antenna is recommended for best reception.
- Connect your home antenna to ANT connection on back of television.
- Select Air mode in the set up menu. (refer to preset menu)

Note: The cable mode is preset from the factory. If you are using an antenna then you must change to Air mode in the Set Up menu. (refer to preset setup menu on p.29)

Incoming Cable From Home Antenna

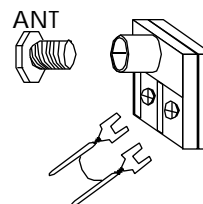

Connecting to Other Equipment

Connecting to DVD Player:

This connection allows you to watch DVD movies and play music CDs.

For normal hook up, you will need the following:

- One pair of audio cables
- One video cable

Note: For better picture quality: If your equipment has S-video connection, use S-video cable instead of a regular video cable.

Follow the steps below to hook up the DVD player.

- 1) Hook up one pair of audio cables to the TV input and DVD output.
- 2) Hook up one video cable to the TV input and DVD output.

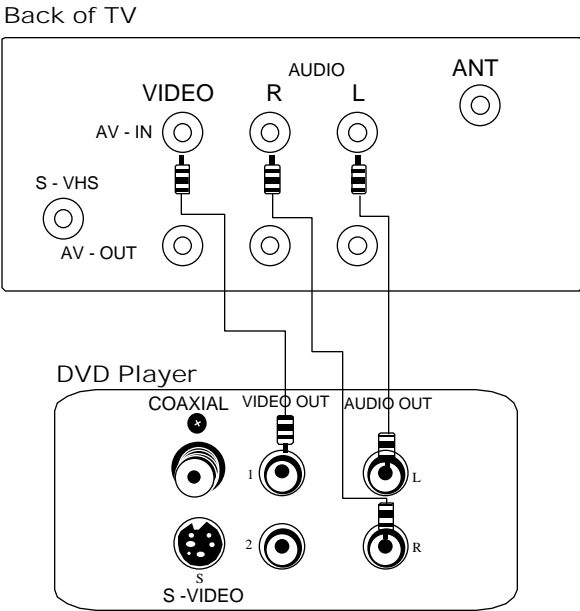

(For a specific installation with home theater system, refer to DVD player's and Home Theater's instructions.)

Connecting to VCR:

This connection allows you to watch local channels and video programs, play or record on the VCR while watching TV. You can also record from one channel while watching another channel.

For normal hook up, you will need the following.

- One coaxial cable
- One pair of audio cables
- One video cable
- An S-video cable is usually included with an S-VHS VCR. If it is not included then you may have to purchase it from local electronics retail store.

Note: If you have a mono VCR, connect one single audio cable to VCR audio out. If you have stereo VCR with S-Video output, use S-Video cable instead of a regular video cable. This type of connection delivers a better picture compared to a standard VHS VCR. Do not connect a regular video cable and S-Video cable to Video 1 or (Video 2) at the same time because it will distort the picture.

Follow the steps below to hook up the VCR.

- 1) Hook up one pair of audio cables to the TV input and VCR output.
- 2) Hook up one video cable to the TV input and VCR output.
- 3) Connect coaxial cable wire to TV antenna on back of the TV and to "Out to TV" on back of the VCR.
- 4) Connect coaxial cable wire that is coming out from cable box or antenna to "In from ANT" on back of the VCR.

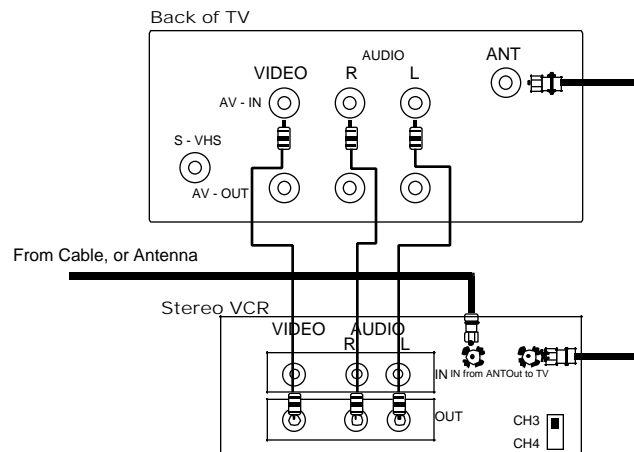

(When recording a program from TV, refer to your VCR's instructions.)

Connecting to Camcorder:

This connection allows you to watch videos recorded on a Camcorder.

For normal hook up, you will need the following.

- One pair of audio cables
- One video cable

Note: If your Camcorder has S-video connection, use S-video cable instead of a regular video cable. This will provide better picture performance than a regular video cable.

Follow the steps below to hook up the Camcorder.

- 1) Hook up one pair of audio cables to the TV input and Camcorder output.
- 2) Hook up one video cable to the TV input and Camcorder output.

Note: Do not connect a regular video cable and S-Video cable to Video 1 or (Video 2) at the same time because it will distort the picture.

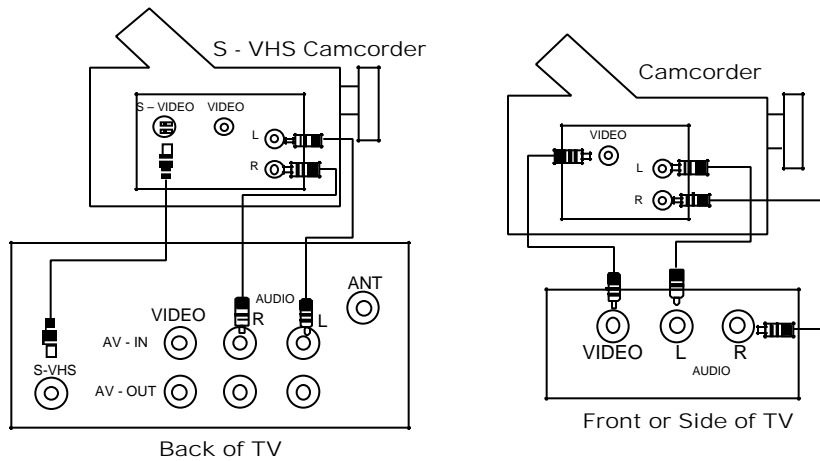

Connecting to an Audio Amplifier:

This connection allows you to have sound from external speakers for surround sound.

For normal hook up you will need the following.

- One pair of audio cables

Follow the steps below to hook up an Audio Amplifier.

- 1) Hook up one pair of audio cables to the TV input and Audio Amplifier output.

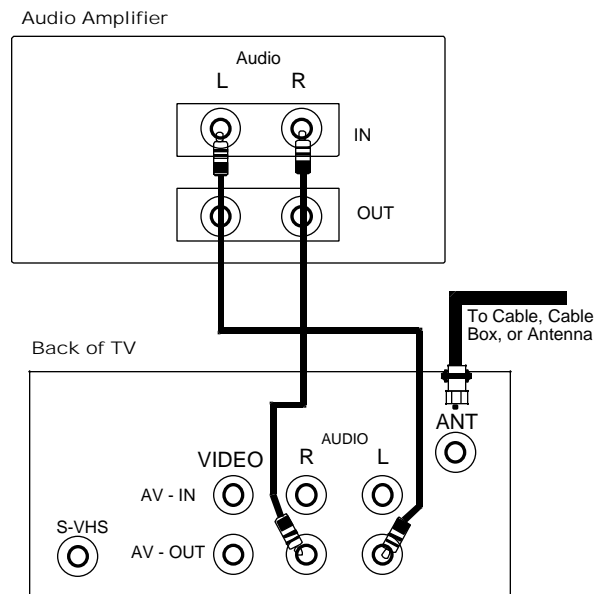

(For a specific hook up installation, refer to an audio amplifier's instructions.)

Connecting to a Cable Box:

This connection allows you to receive stereo broadcasts only and watch cable channels.

Note: You must subscribe cable service from your local cable company in order to watch cable channels.

For normal hook up, you will need the following.

- One coaxial cable

Follow the steps below to hook up the Cable Box.

- 1) Locate the cable that is connected to the "ANTENNA OUT" terminal on your cable box. (Some cable boxes may have "ANT OUT", "VHF OUT" or "OUT" printed on.)
- 2) Connect the other end of this cable to the VHF/UHF antenna terminal on the back of the TV.

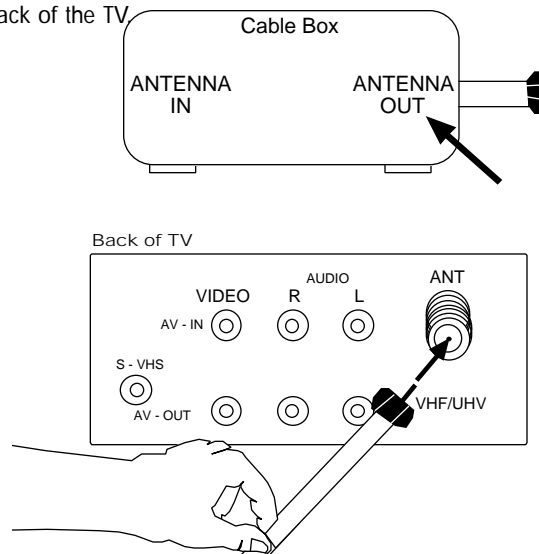

(For a specific hook up installation, refer to Cable Box's instructions.)

Power Interruptions

- Occasionally there may be power interruptions due to thunderstorms or other causes. Remove the power cord from AC outlet when a power outage occurs. When power has been restored re-plug power cord to AC outlet.

Features and Operation

HTF27R11 - 27" TV

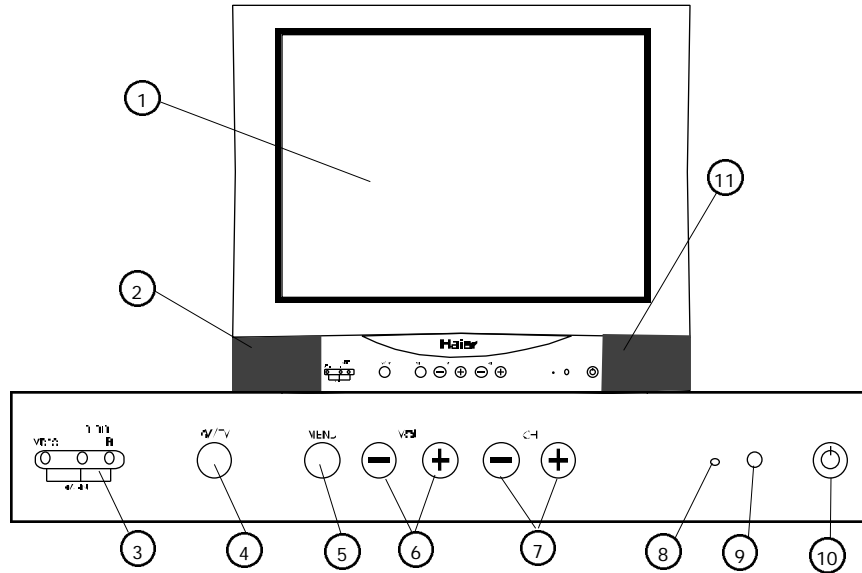

- | | |
|-----------------------------------|---------------------------|
| 1. Picture Tube | 7. Channel Control Button |
| 2. Left Speaker | 8. Power-On Light |
| 3. Front Audio/Video Hookup Jacks | 9. Remote Sensor |
| 4. AV/TV Input Button | 10. Power Button |
| 5. Menu Button | 11. Right Speaker |
| 6. Volume Control Button | |

TV Rear Panel

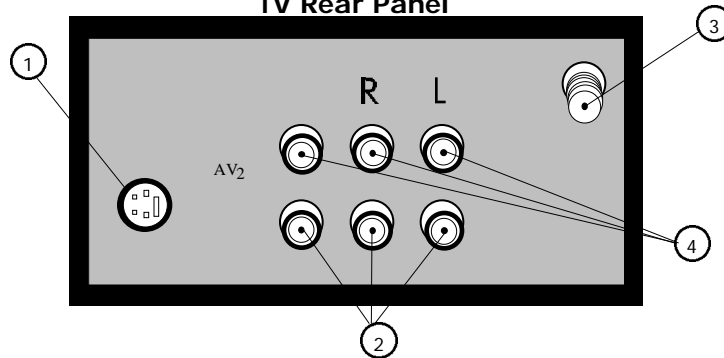

- | | |
|---|--|
| 1. Super VHS Hookup Jack | 3. Cable TV Antenna Hookup |
| 2. Rear Audio/Video Hookup Jacks
V-video output
L-left channel output
R-right channel output | 4. Rear Audio/Video Hookup Jacks
V-video input
L-left channel input
R-right channel input |

Features and Operation

HTF24R21 - 24" TV

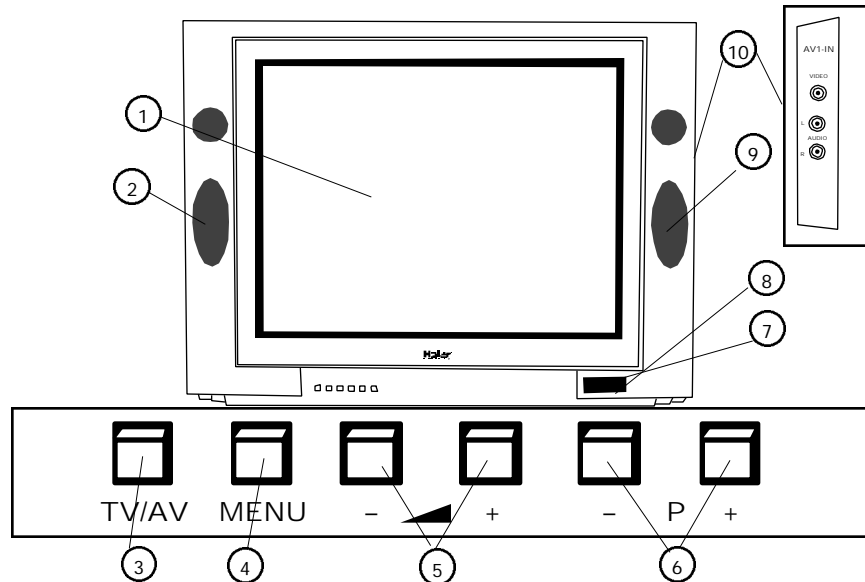

- | | |
|---------------------------|-----------------------------------|
| 1. Picture Tube | 7. Remote Sensor |
| 2. Left Speaker | 8. Power Button |
| 3. TV/AV Input Button | 9. Right Speaker |
| 4. Menu Button | 10. Side Audio/Video Hookup Jacks |
| 5. Channel Control Button | |
| 6. Volume Control Button | |

TV Rear Panel

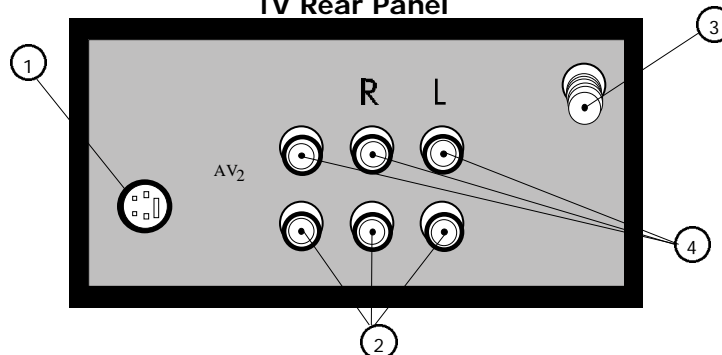

- | | |
|---|--|
| 1. Super VHS Hookup Jack | 3. Cable TV Antenna Hookup |
| 2. Rear Audio/Video Hookup Jacks
V-video output
L-left channel output
R-right channel output | 4. Rear Audio/Video Hookup Jacks
V-video input
L-left channel input
R-right channel input |

Features and Operation

HTF20R21 – 20" TV

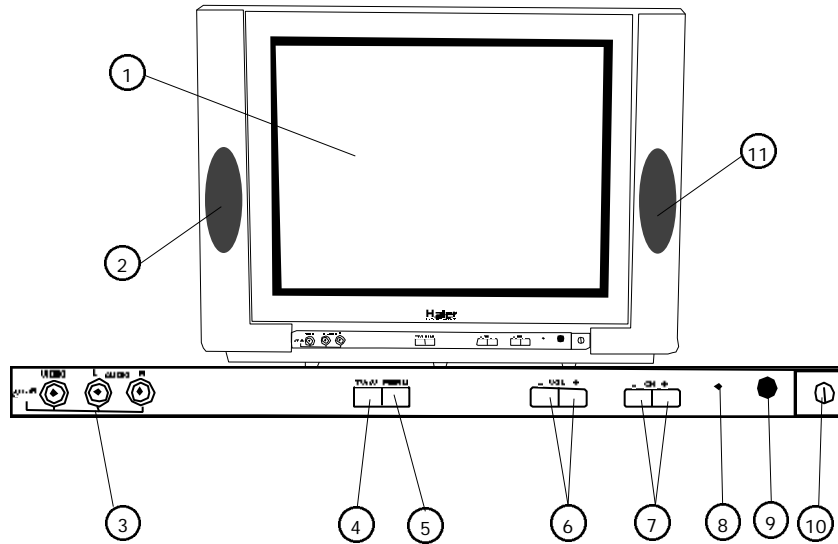

- | | |
|-----------------------------------|---------------------------|
| 1. Picture Tube | 7. Channel Control Button |
| 2. Left Speaker | 8. Power-On Light |
| 3. Front Audio/Video Hookup Jacks | 9. Remote Sensor |
| 4. TV/AV Input Button | 10. Power Button |
| 5. Menu Button | 11. Right Speaker |
| 6. Volume Control Button | |

TV Rear Panel

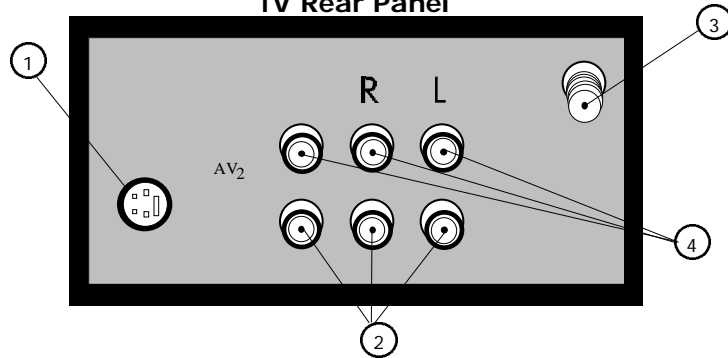

- | | |
|---|--|
| 1. Super VHS Hookup Jack | 3. Cable TV Antenna Hookup |
| 2. Rear Audio/Video Hookup Jacks
V-video output
L-left channel output
R-right channel output | 4. Rear Audio/Video Hookup Jacks
V-video input
L-left channel input
R-right channel input |

TV Features

Power Button: (10)

To turn power ON or OFF, press the power button on your TV set. Your TV has "curtain effect" to give you theater view. You will see when you turn power ON, the curtain will open to the sides on your screen. When you turn power OFF, the curtain will come to the center and screen will be closed.

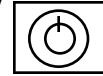

Channel Control Button: (7)

Press CH (+) button to go up and CH (-) button to go down on your TV set.

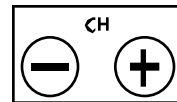

Volume Control Button: (6)

Press button VOL (+) to increase the volume and VOL (-) button to decrease the volume.

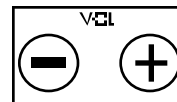

AV/TV Input Button: (4)

Press TV/AV button to select the video input (VIDEO 1, VIDEO 2 or TV input)

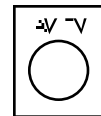

Menu Button: (5)

Press menu button to set up the TV channels, picture, audio, clock/alarm, V-Chip and other options. (refer to remote menu operations)

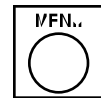

Front Audio/Video Hook Up Jack: (3)

This allows you to hook up other components such as Camcorder, Game System, etc. for your convenience.

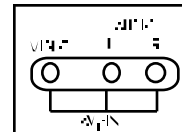

Rear Audio/Video Inputs: (2)

Rear A/V inputs are used for components you normally leave connected to your TV. This provides improved picture and sound quality compared to using the "everything on one wire RF antenna input."

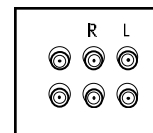

Rear S-VHS Input: (1)

This input gives you high-resolution video picture when hooked up with components such as DVD players, DIRECT TV systems, S-VHS/Hi-8 VCRs, Camcorders, or Internet set-top devices.



Remote Features

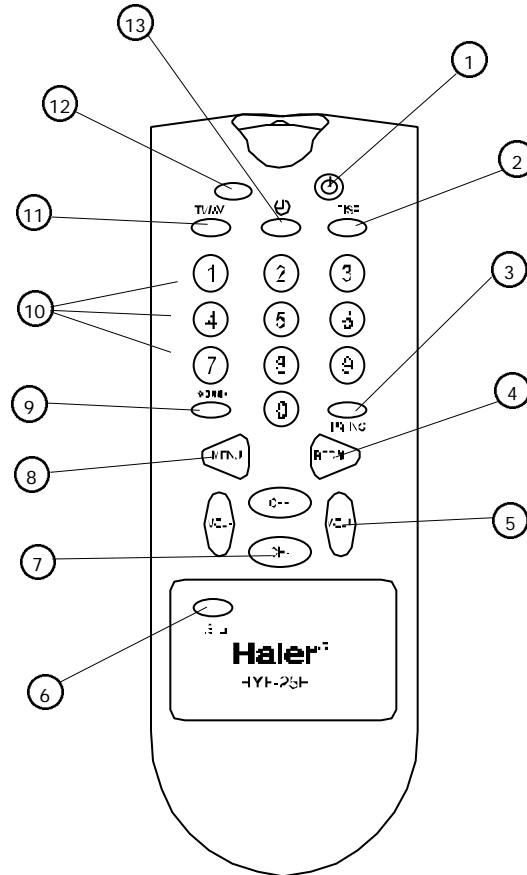

- | | |
|---|----------------------------------|
| 1. Power Button | 8. Menu Select Button |
| 2. Time & Channel Display Button | 9. Audio Select Button |
| 3. Rating Button
TV Program (V-Chip Setup) | 10. Direct Access Channel Select |
| 4. Last Channel Recall Button | 11. TV/AV Input Button |
| 5. Volume (+ / -) Select Button | 12. Mute Button |
| 6. Personal Preference Slect | 13. Sleep Timer |
| 7. Channel (+ / -) Select Button | |

Remote Features

Power Button: (1)

To turn power ON or OFF, press power button on remote control.

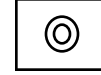

Time and Channel Display Button: (2)

This will show you the current playing channel number.
Clock time will also be displayed if set.



Sleep Timer Button: (13)

This feature allows you to turn off television in pre-selected minutes (120, 105, 90, 75, 60, 45, 30 and 15).
To cancel, keep pressing button until you exit out.

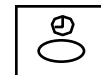

TV/AV Input Button: (11)

This button has three setting. A) Video1, B) Video 2, C) TV Pressing this button will take you to the appropriate setting.

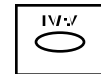

Mute Button: (12)

Press mute button to turn off the TV volume.



Direct Access Channel Select: (10)

Follow the procedure below to select the channel.

One Digit Channel Select:

When you want to select one digit channel, press 0 and other digit.

Two Digit Channel Select:

When you want to select two-digit channel, press one digit after the other continuously.

Three Digit Channel Select:

When you want to select three digit channel, press and hold # "1" until you see "1_ _" displayed on the screen then press other two digits.

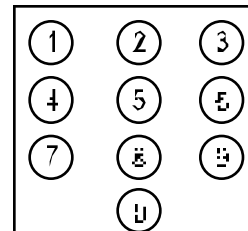

Audio Button: (9)

You can select Stereo, Mono or SAP (Second Audio Programming) choice by pressing audio button. Whenever you change the channel, you will see the text message on the bottom left corner such as "Stereo Received", "Stereo SAP Received" or "Mono Received". This message depends on the broadcast format of the TV program.



Note: Some TV programs are broadcast in another sound channel; that is called SAP (Second Audio Programming). Here the program is also broadcasts in another language such as Spanish or French.

Channel (+ / -) Select Button: (7)

You can go up and down the channels by pressing CH (+) button and CH (-) button.

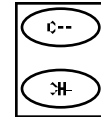

Volume (+ / -) Select Button: (5)

You can increase the volume by pressing VOL (+) button and decrease VOL (-) button.



Last Channel Recall Button: (4)

This feature automatically puts the last channel into the memory so when you press the recall button that channel comes right back to watch.



Personal Preference Select Button: (6)

By pressing this exclusive personal preference button, you can select different preset brightness shades for different picture environment. You can select from Personal, Standard, Vivid, Soft and Light choice of brightness shades for different picture environment.



Rating Button: (3)

Press this button to view television programs and movie rating codes. This function enables you to block certain TV channels in according to the V-CHIP requirement established by the FCC.



V-Chip Technology:

The "V-Chip Technology" allow you to use U.S. and Canada MOVIES and TV PROGRAMS Guide ratings to block certain types of TV programs and movies.

To understand clearly about TV programs rating codes, read the following list:

U.S. TV Program Ratings

NR: Not Rated – this means that programs are not rated or rating does not apply.

TV-Y: For all children – this type of rated programs are designed for a very young audience, including children from ages 2-6.

TV-Y7: Directed for older children –this type of rated programs may includecomedic violence or mild physical, or may frighten children under the age of 7.

TV-G: General Audience – this type of rated programs contains little or no violence, no strong language, and little or no sexual dialogue and situations.

TV-PG: Parental Guidance Suggested – this type of rated programs may contain limited violence, some suggestive sexual dialogue and situations, and rare language.

TV-14: Parents strongly cautioned – this type of rated programs may contain sexual content, strong language and more intense violence.

TV-MA: Mature audience only – this type of rated programs may contain graphic violence, explicit sexual content and profane language.

FV: this type of rated programs contain Fantasy and cartoon violence.

Violence: this type of rated programs contain violence.

S: this type of rated programs contain sex.

L: this type of rated programs contain offensive language.

D: this type of rated programs contain dialogue with sexual content.

To understand clearly about movies rating codes, read the following list:

U.S. Movies Rating Chart

NR: This means movie is not rated yet. It is pending government rating approval.

G: General Audience – this type of movie rating means all ages admitted to see the movie.

PG: Parental Guidance Suggested – this type of movie rating means some material may not be suitable for children.

PG-13: Parents Strongly Cautioned – this type of movie rating means some material may not be appropriate for children under 13.

R: Restricted – This type of movie rating means children under 17 of age requires to be with parent or guardian.

NC-17: This type of movie rating means no one 17 and under admitted.

X: This type of movie rating means adults only.

To understand clearly about Canadian programs rating codes, read the following list:

Canadian English Rating Chart

E: Exempt – this type of rated programs contain news, sports, documentaries, talk shows, music video's, and variety of other programs.

C: This type of rated programs are intended for children under age 8. There is no offensive language, nudity or sexual content.

C8+: This type of rated programs generally considered acceptable for children 8 years and over. There is no profanity, nudity or sexual content.

G: This type of rated programs generally suitable for all audiences.

PG: Parental Guidance Suggested – in this type of rated programs, some material may not be suitable for children.

14+: In this type of rated programs, some content may not be suitable for viewers under the age of 14. Parents are strongly cautioned not to have their children view 14+ rated programs by pre-teens and early teens.

18: Adults Only – this type of rated programs are only for adult viewers only.

V-CHIP Set Up:

Pressing "Rating Button" on your remote control will bring V-Chip set up display on TV. You will see the following on your TV screen.

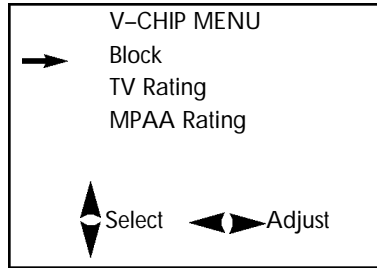

This function enables you to block certain TV channels in according to the V-CHIP requirement established by the FCC.

Follow the procedure below to set the V-CHIP:

Press the Rating button. You will see the V-CHIP menu on your TV screen:

1. Press CH (+) button and CH (-) button to go up and down the menu:
2. Press VOL (+) button and VOL (-) button to go into TV Rating and Movie Rating menu.
3. Press MENU button to set the BLOCK ON and BLOCK OFF.

When TV rating is selected, you will see the following rating table on your TV screen.

Rating	FV	D	L	S	V
TV-YU					
TV-Y7U					
TV-GU					
TV-PGU		U	U	U	U
TV-14U		U	U	U	U
TV-MAU			U	U	U

Age Based Rating

Note: When block "ON" is selected, you will see "B" instead of "U". When block "OFF" is selected, you will see "U" instead of "B".

English

When Movie rating is selected, you will see the following rating table on your TV screen.

Movie Rating	
NR	U
G	U
PG	U
PG13	U
R	U
NC17	U
X	U
Age Based Rating	

Note: When block "ON" is selected, you will see "B" instead of "U". When block "OFF" is selected, you will see "U" instead of "B".

- BLOCK OFF means block function is turned off. If the BLOCK is on "OFF" mode then V-CHIP function will not be active to input V-CHIP signal.
- BLOCK ON means block function is turned on. If the block is on "ON" mode then V-CHIP function is activated to input V-CHIP signal.

Password

The "Default Password" preset by manufacturer is "0000". If you want to change the preset password to your own password, just choose any four digits that you can easily remember and set it. Once you set password for the particular channel, that channel will be blocked. This way you are the only one who can access that channel.

Menu Features

Picture Set up:

- Pressing MENU button once will bring Picture Set Up display on TV. You will see the following on your TV screen.

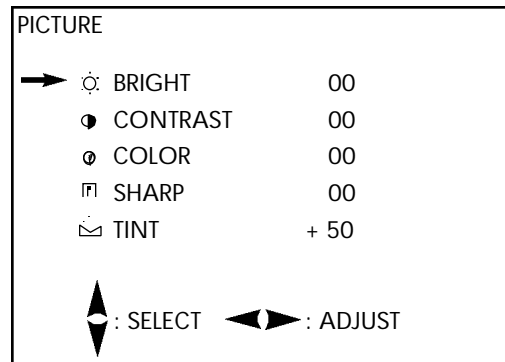

Follow the procedure below to adjust the picture quality of your choice:

- Press CH (+) button to go up and press CH (-) button to go down the menu.
- Press VOL (+) button to increase and VOL (-) button to decrease the level to your preference for each item.

Adjustment of Picture Quality:

To adjust the picture quality from the factory preset read the following:

BRIGHT: 00 being the lowest and 100 being the highest level of adjustment.

CONTRAST: 00 being the lowest and 100 being the highest level of adjustment.

COLOR: 00 being the lowest and 100 being the highest level of adjustment.

SHARP: 00 being the lowest and 100 being the highest level of adjustment.

TINT: - 50 being the lowest and + 50 being the highest level of adjustment.

- Bright (Brightness):** By increasing the level, it will add more light to dark parts of the picture and by decreasing the level, it will add more dark to light parts of the picture.
- Contrast:** By increasing the level, it will adjust white areas of picture and by decreasing the level, it will adjust black areas of picture.
- Color:** By increasing the level, it will increase color richness and by decreasing the level, it will lower color to black and white.
- Sharp (Sharpness):** By increasing the level, it will show cleaner and clearer images and by decreasing the level, it will make picture smoother.
- Tint:** By increasing the level, it will give red tint to skin color and by decreasing the color, it will give green tint to skin color.

Audio Set Up:

- By pressing MENU button twice will bring you to Audio Set Up display. You will see the following on your TV screen.

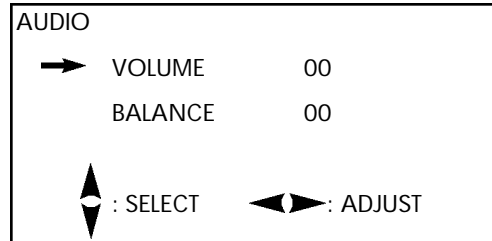
**Follow the procedure below to adjust the sound quality:**

1. Press CH (+) button to go up and press CH (-) button to go down the menu.
2. Press VOL (+) button to increase and VOL (-) button to decrease the level to your preference.

Adjustment of Audio Quality:

Audio: 00 being the lowest or no volume at all and 100 being the highest or loudest volume.

Balance: 00 being the even distribution of sound for both speakers and you must keep at this level. The range of distribution is - 50 to + 50. If you increase the level, you will here more sound coming out of right hand side speaker only. If you decrease the level, you will here more sound coming out of left hand side speaker only.

Note: You must distribute the volume evenly to both speakers otherwise you may blow up one of the speakers.

Language Option Set Up:

By pressing the MENU three times will bring you to Language set up menu. You will see the following on your TV display:

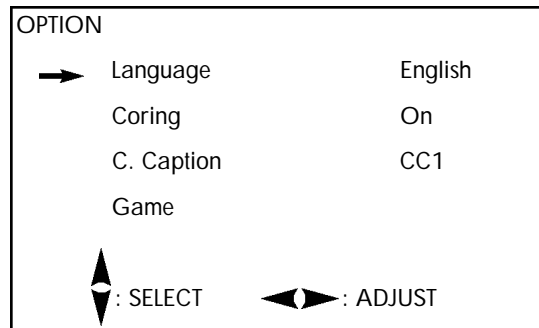

Follow the procedure below to select one of the above options:

1. Press CH (+) button to go up and press CH (-) button to go down the menu.
 2. Press VOL (+) button or VOL (-) button to select your preference.
- Language: Use VOL (+/-) to select from English, Spanish, French or Portuguese.
 - Coring: Press VOL (+) to have Coring On or Press VOL (-) to have Coring OFF. Coring is a term for video noise reduction. A built-in device in the TV set to reduce video noise interference so the viewer is always assured a clear, noise free picture.
 - C. Captions: Press VOL (+) button or VOL (-) button to select Closed Caption options. Closed Caption helps the hearing-impaired and children learn read. It also aids in the teaching of English as a second language. A built-in decoder displays the audio portion of a program as text on the TV screen when this option is selected.

OFF: When OFF displays on TV means C. Caption is set off.

CC1: When C1 displays on TV means C. Caption is set active.

CC2 to CC4: For other modes of video related information to be displayed by broadcasters.

TT1: For program guide and other information to be displayed by broadcasters. (This blocks large portion of the picture on your TV).

TT2 to TT4: For other modes of information to be displayed by broadcasters. (This blocks large portion of the picture on your TV).

Note: Select C1 for full translation of the primary language such as English in your area. Select C2 for secondary language translation such as Spanish or whatever is being broadcast in our area.

Game:

- Your TV has been designed with a video game for your entertainment. To play video game, select game on menu and press VOL (+) button.

You will then see the following display on TV:

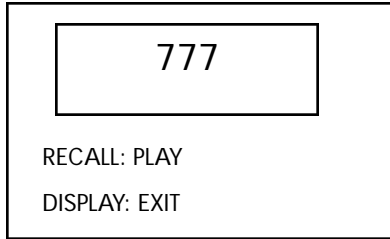

Follow the procedure below to play the game:

1. First pick three numbers at random.
2. Press RECALL button to play the game. You will see numbers are scrolling.
3. Press RECALL button three times to select three random numbers. This will stop the scrolling and you will see three random numbers on display. If your number matches the one you have picked then you win the game. If not then start the new game.
4. Repeat first three steps to play the game again.
5. Press DISPLAY button to exit the game mode.

Clock Set Up:

- By pressing the MENU button four times will bring you to Clock set up menu.

You will see the following on your TV screen:

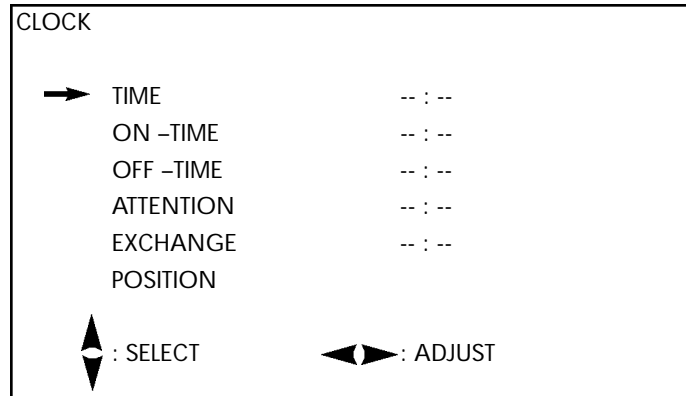

Follow the procedure below to select one of the above options:

1. Press CH (+) button to go up and press CH (-) button to go down the menu.
 - Time: Press VOL (+) button for MINUTES and VOL (-) button for HOURS adjustment.
 - On - Time: Press VOL (+) button for MINUTES and VOL (-) button for HOURS adjustment. This feature works like an alarm clock. Your TV will turn on at the set time.
 - Off -Time: Press VOL (+) button for MINUTES and VOL (-) button for HOURS adjustment. This feature works like a sleep timer. Your TV will turn off at the set time.
 - Attention: Press VOL (+) button to set MINUTES of attention and VOL (-) button to set HOUR of attention. You will see the flashing time on your TV when the attention time is up. **Note:** This exclusive feature will remind you of important chores while watching TV. (e.g. time to take pills, time to check cooking, time to call, time to do homework etc..)
 - Exchange: This exclusive feature switches you to your favorite channel at the appropriate set time. Press VOL (+) button to set up time in MINUTES to switch the channel and VOL (-) button to set up time in HOURS to switch the channel.
 - Position: This feature lets you store the favorite channel. Once you store the channel number in this function, when the set time is up, it will switch over to the set channel. This feature is used with the Exchange feature. Press VOL (+) button to go up and VOL (-) button to go down to select the channel.

Preset Set Up:

- By pressing MENU button five times it will bring you to preset set up.

You will see the following display on TV screen.

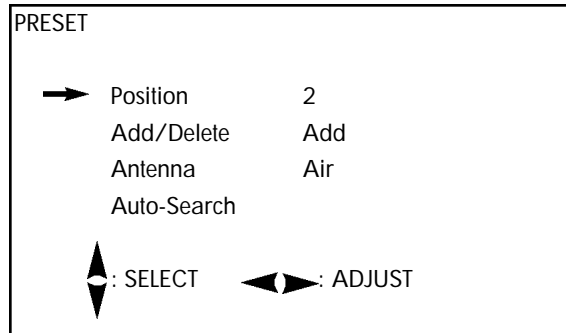

Follow the procedure below to select above options:

Press CH (+) button and CH (-) button to go up and down the menu.

- Position: Press VOL (+) button to go up and VOL (-) button to go down to set the channel position.
The display will show the current playing channel.
- Add/Delete: Press VOL (+) button or VOL (-) button to add or delete the channel from the stored memory.
- Antenna: Press VOL (+) button or VOL (-) button to select Air or Cable.

Channel Coverage by Antenna:

Antenna Type	Channel Range
VHF	2-13
UHF	14-69
CATV	1-125

- Auto -Search: Press VOL (+) button or VOL (-) button to do auto search. In this process, the search automatically adds only the active channels in your area to the TV's memory. It deletes any channels on which there is no broadcast.

Care and Cleaning



Warning: Always unplug your television to avoid electric shock before cleaning. Ignoring this warning may result in death or injury.

Caution: Before using any cleaning products, always read and follow manufacturer's instructions and warnings to avoid personal injury or product damage.

- When cleaning the television, turn off the TV and unplug it.
- Use a mild soap solution or window cleaner with a soft clean cloth.
- Do not use any abrasive, harsh chemicals, ammonia, chlorine bleach, concentrated detergent, solvents, benzene, and other petroleum based products. Some of these chemicals may dissolve, damage and/or discolor your screen and the cabinet.
- Use a soft cloth dampened with water or a mild detergent solution for cabinet and remote control cleaning.
- Do not use excessive moisture and wipe dry.



Warning: Do not spray any type of cleaning fluid directly on the screen.

Troubleshooting

Before you call for service, your television problems can be fixed with a few minor adjustments. Identify the type of problem you are having and then try some suggestions below to get your television going on again.

Power

TV is not turning on:

- Check the plug to see if it is plugged in properly. If the plug is plugged in properly but TV is still not turning on then plug something else into the outlet to make sure it is working. If outlet is dead then you will have to use another working outlet. Make sure that you are aiming the remote control directly at the TV where the sensor is located and stay within the proper range; that may be required in order to receive the signal from the remote. Replace new batteries into the remote control and try turning it on. If TV still not turning on after replacing remote batteries then there could be a sensor problem. Try turning it on by pressing the power button on your TV.

TV has power but no sound and no picture:

- Switch to another channel. Possibly an inactive channel may be tuned in. Check the hook up of other components such as cable box, receiver and set-top box. Check if you need to have any one of the above components turn on in order to have your TV on. Check if you have pressed the TV/Video button on your remote by mistake. This can bring your monitor screen on. Press the TV/Video button again to go to channel. Make sure the TV/VCR button on the VCR is in the correct position when using the VCR. Make sure that the TV is tuned to the same channel as the switch on the back of the VCR if you are watching a VCR.

Picture

Snowy Video:

- Check antenna connections. Adjust antenna location.

Multiple Images:

- Check your cable wire connection. Adjust antenna connection and location.

No picture and No video (blank screen)

- Make sure the plug is in active outlet. Check cable connections. Check second video source operation e.g. receiver. You may need to change to TV mode to go to channel.

TV turns Off/On by itself

- This is due to power surge. Check sleep timer. Check alarm On/Off Time and see if you have set up alarm properly. Check Clock Time

Remote

Some buttons on remote do not work

- This may occur due to not cleaning remote properly. You may have dropped remote couple of times and damaged some buttons on your remote. May need to replace remote.

Sometimes remote works and sometimes does not work

- Make sure batteries are not dead. May need to replace new batteries.

Not able to select certain channels

- You may need to add channels into memory. Check auto program set up. Check your cable box setting.

Sound

Noisy audio

- Broadcasting reception may not be clear. Adjust Antenna location and connection.

No audio but picture is on

- Check mute and increase volume button. Change to different channel to see if the volume is on. Check if you need to turn on other component such as receiver. Check if it is on TV mode.

Poor audio quality

- Check audio setting such as Stereo verses Mono on receiver.

Glossary

Antenna

An external device connected to a TV to receive the electromagnetic signal it needs to produce the picture. They can be mounted on the roof, in the attic, or on top of the set itself.

Attention

This feature reminds you of important chores while watching TV.

Audio

You can select Stereo, Mono or SAP choice by pressing audio button on the remote control. Whenever you change the channel, you will see the text message on the bottom left corner such as "Stereo Received", "Stereo SAP Received", "Mono Received". This message depends on the broadcast format of the TV program.

Audio/Video Inputs

This allows you to hook up components such as VCR, DVD Player, Camcorder, Game System, Set Top Boxes, Home Theater System, Cable Boxes and Internet Set-Top devices etc.

Auto Closed Caption on Mute

In this feature, text appears on screen when mute button is pressed. When you have to mute the TV, you will not miss a word of dialogue.

Auto Search

A feature on TVs and VCRs that automatically searches for active channel signals and inputs them into its system, while locking out inactive signals.

Bilingual Broadcasts

The simultaneous transmission of television programs in more than one language, using SAP (Second Audio Programming) technology.

Bright (Brightness)

You can adjust brightness of the picture by going into picture set up menu. By increasing the level, it will add more light to dark parts of the picture and by decreasing the level, it will add more dark to light parts of the picture.

Cable Ready/Compatible

Terms used for TV or VCR that is capable of receiving all channels offered by cable television. This includes mid-band and super channels, without the converter box that is supplied by the Cable Company.

Cathode Ray Tube (CRT)

A color picture tube used in television system. Electro guns generate beams that are guided to illuminating small red, green and blue phosphor targets on the surface. This produces colors and images on the screen.

Channel Button

This button allows you to go up and down the channels by pressing CH (+) and CH (-) button.

Channel Recall

This feature automatically puts the last channel into the memory so when you press the recall button that channel comes right back to watch.

Closed Caption

Closed Caption helps the hearing-impaired and children learn to read. It also aids in the teaching of English as a second language. A built-in decoder displays the audio portion of a program as text on the TV screen when this option is selected.

Color

You can adjust the color of the picture by going into picture set up menu. By increasing the level, it will increase color richness and by decreasing the level, it will lower color to black and white.

Contrast

You can adjust the contrast of the picture by going into picture set up menu. By increasing the level, it will adjust white areas of picture and by decreasing the level, it will adjust black areas of picture.

Coring (Video Noise Reduction)

The term coring is used for video noise reduction to reduce video noise interference so the viewer is always assured a clear, noise free picture.

Curtain Effect

Exclusive "Theater Curtain" On/Off Digital Circuitry eliminates "Screen Flash" while prolonging the life of the picture tube.

Direct Access Channel Select

By directly entering channel number from 0 to 9 on your remote will give you quick and easy access to switch from one channel to another. If you want to select a two or three digit channel number, by pressing (- -) button twice will give you access to enter your desired channel numbers form 10-99. By pressing (- -) three times will give you access to enter your desired channel numbers from 100 and up.

Display Button

This will show you the current playing channel number. Clock time will also be displayed is set.

Exchange

This feature lets you switch to your favorite channel at the appropriate set time.

Menu Button

This allows you to access all the TV menus such as Picture Set Up, Audio Set Up, Language Option Set Up, Clock Set Up and Preset Set Up.

MTS Stereo Sound

A built - in amplifier that gives you stereo sound. An amplifier is used to increase the voltage of power of any power signal that is fed to it. MTS is the U.S. standard for broadcast stereo TV sound. A large number of TV shows are now broadcast in stereo sound using this technology.

Mute

This feature allows you to block the volume of the TV when the button is pressed.

Parental Lock/Channel Block

This feature allows you to program security codes to certain channels; typically used by parents to prevent children from viewing "adult" channels. Channels are blocked and unblocked using the TV set's wireless remote control.

Personal Preference Button

This feature allows you to select different preset brightness shades for different picture environment. You can select from Personal, Standard, Vivid, Soft and Light choice of brightness shades for different picture environment.

Position

This feature lets you store the favorite channel. Once the channel is stored in this function, when the set time is up, it will switch over the set channel. This feature is used in conjunction with the "Exchange" feature.

Rating Button

This allows you to view Television programs and movies rating codes. This function enables you to block certain TV channels in according to the V-CHIP requirement established by the FCC.

Sleep Timer

This feature allows you to turn off television in pre-selected minutes (120, 105, 90, 75, 60, 45, 30 and 15).

Sharp (Sharpness)

You can adjust the sharpness of the picture by going into picture set up menu. By increasing the level, it will show cleaner and clearer images and by decreasing the level, it will make picture smoother.

Super VHS Input

This input gives you "High Resolution" video picture when hooked up with components such as DVD players, Direct TV systems, S-VHS/Hi-8 VCRs, Camcorders, or Internet Set-Top devices.

Tint

You can adjust the tint of the picture by going into picture set up menu. By increasing the level, it will give red tint to skin color and by decreasing the color it will give green tint to skin color.

Volume Button

This allows you to increase and decrease the volume of the TV by pressing VOL (+) and VOL (-) button.

V-Chip Technology

The "V-Chip Technology" allow you to use U.S. and Canada Movies ad TV Programs Guide ratings to block certain types of TV programs and movies.

Warranty

This Haier brand product, when shipped in its original container, will be free from defective workmanship and materials, and agrees that it will, at its option, either repair the defect or replace the defective product with a new or re-manufactured equivalent at no change to the purchaser, for parts or labor for the periods set forth below:

This warranty does not apply to the appearance of the product or the exterior of the product, which has been damaged or defaced, altered or modified in design or construction. It does not apply to the additional excluded items set forth below:

The warranty commences on the date the item was purchased and the original purchase receipt must be presented to the authorized service center before warranty repairs are rendered.

The limited warranty described herein is in addition to whatever implied warranties may be granted to purchasers by law. ALL IMPLIED WARRANTIES INCLUDING THE WARRANTIES OF MERCHANTABILITY AND FITNESS FOR USE ARE LIMITED TO THE PERIOD(S) FROM THE DATE OF PURCHASE SET FORTH BELOW. Some states do not allow limitations on how long an implied warranty lasts, so the above limitation may not apply to you.

Neither the sales personnel of the seller nor any other person is authorized to make any warranties other than those described herein, or to extend the duration of any warranties beyond the time period described herein on behalf of Haier.

The warranties described herein shall be the sole and exclusive warranties granted by Haier and shall be the sole and exclusive remedy available to the purchaser. Correction of defects in the manner and for the period of time described herein, shall constitute complete fulfillment of all abilities and

responsibility of Haier to the purchaser with respect to the product, and shall

constitute full satisfaction of all claims, whether based on contract, negligence, strict liability or otherwise. In no event shall Haier be liable, or in any way responsible for any damages or defects in the product which were caused by repairs or attempted repairs performed by anyone other than an authorized service center or dealer; nor shall Haier be liable, or in any way responsible for incidental or consequential economic or property damage. Some states do not allow the exclusion of incidental or consequential damages, so that above exclusion may not apply to you.

THIS WARRANTY GIVES YOU SPECIFIC LEGAL RIGHTS. YOU MAY ALSO HAVE OTHER RIGHTS WHICH VARY FROM STATE TO STATE.

Warranty period for this product: 90 days for Labor, one year for parts, and 2 years for picture tube.

Additional items excluded from warranty coverage: non-rechargeable batteries.

Where to obtain service: For the location of the nearest Haier authorized service center or to obtain product literature, accessories, supplies or customer assistance, please call 1-877-337-3639.

What to do to obtain service: ship or carry in your product to an authorized service dealer or center. Be sure to have proof of purchase. If you ship the product, be sure it is packaged carefully.

Haier America
New York, NY 10018

IMPORTANT

Do Not Return This Product To The Store

If you have a problem with this product, please contact the "Haier Customer Satisfaction Center" at 1-877-337-3639.

DATED PROOF OF PURCHASE REQUIRED FOR WARRANTY SERVICE

IMPORTANT

Ne pas Réexpédier ce Produit au Magasin

Pour tout problème concernant ce produit, veuillez contacter le service des consommateurs 'Haier Customer Satisfaction Center' au 1-877-337-3639.
UNE PREUVE D'ACHAT DATEE EST REQUISE POUR BENEFICIER DE LA GARANTIE.

IMPORTANTE

No regrese este producto a la tienda

Si tiene algún problema con este producto, por favor contacte el "Centro de Servicio al Consumidor de Haier" al 1-877-337-3639 (Válido solo en E.U.A).

NECESITA UNA PRUEBA DE COMPRA FECHADA PARA EL SERVICIO DE LA GARANTIA

Made in China
Fabriqué en Chine
Hecho en China

Haier[®]
■ ● ● ● ● ●
What The World Comes Home To[™]

HTF27R11-2
Issued: September-01

Haier America
New York, NY 10018

Part # TV-9999-01

Printed in China