

COLOR TELEVISIONS

INSTRUCTION MANUAL

PF2020 PF2720 PF3220
PF2030 PF2730 PF3230



Please read this manual carefully before operation.

WARNING

To reduce the risk of fire or electric shock, do not expose this product to rain or moisture.

The apparatus shall not be exposed to dripping or splashing and that no objects filled with liquids, such as vases, shall be placed on the apparatus.



Caution: To reduce the risk of electric shock, do not remove cover (or back). No user serviceable parts inside. Refer servicing to qualified service personnel.



This symbol indicates "dangerous voltage" inside the product that presents a risk of electric shock or personal injury.



This symbol indicates important instructions accompanying the product.

Caution: To prevent electric shock, match wide blade of plug to wide slot, fully insert.

Attention: Pour éviter les chocs électriques, introduire la lame la plus large de la fiche dans la borne correspondante de la prise et pousser jusqu' au fond.

Refer to the identification/rating label located on the back panel of your product for its proper operating voltage.

Caution: Using video games or any external accessory with fixed images for extended periods of time can cause them to be permanently imprinted on the picture tube (or projection TV picture tubes). ALSO, some network/program logos, phone numbers, etc. may cause similar damage. This damage is not covered by your warranty.

Cable TV Installer: This reminder is provided to call your attention to Article 820-40 of the National Electrical Code (Section 54 of the Canadian Electrical Code, Part 1) which provides guidelines for proper grounding and, in particular, specifies that the cable ground shall be connected to the grounding system of the building as close to the point of cable entry as practical.

Customer Record

You will find the model number and chassis number of your TV on the back of your TV set. Record these numbers in the spaces provided below. Refer to them whenever you call APEX Digital customer service or your APEX dealer regarding this product.

Model Number: _____

Chassis Number: _____

PACKING LIST	
Parts	QTY
Color TV Receiver	1
Remote Control	1
Operation Manual	1
AAA Alkaline Batteries	2

IMPORTANT SAFETY INSTRUCTIONS

1. Read these instructions.
2. Keep these instructions.
3. Heed all warnings.
4. Follow all instructions.
5. Do not use this apparatus near water.
6. Clean only with dry cloth.
7. Do not block any ventilation openings. Install in accordance with the manufacturer's instructions.
8. Do not install near any heat sources such as radiators, heat registers, stoves, or other apparatus (including amplifiers) that produce heat.
9. Do not defeat the safety purpose of the polarized or grounding-type plug. A polarized plug has two blades with one wider than the other. A grounding type plug has two blades and a third grounding prong. The wide blade or third prong is provided for your safety. If the provided plug does not fit into your outlet, consult an electrician for replacement of the obsolete outlet.
10. Protect the power cord from being walked on or pinched particularly at plugs, convenience receptacles, and the point where they exit from the apparatus.
11. Only use attachments/accessories specified by the manufacturer.
12. Use only the cart, stand, tripod, bracket, or table specified by the manufacturer, or sold with the apparatus. When a cart is used, use caution when moving the cart/apparatus combination to avoid injury from tip-over.
13. Unplug this apparatus during lightning storms or when unused for long periods of time.
14. Refer all servicing to qualified service personnel. Servicing is required when the apparatus has been damaged in any way, such as power-supply cord or plug is damaged, liquid has been spilled or objects have fallen into the apparatus, the apparatus has been exposed to rain or moisture, does not operate normally, or has been dropped.
15. **Warning - This TV should only be serviced by an authorized and properly trained technician. Opening the cover or other attempts by the user to service this TV may result in serious injury or death from electrical shock, and may increase the risk of fire.**



IMPORTANT STAND AND BASE SAFETY INFORMATION

Choose the location for your TV carefully. Place the TV on a stand or base that is of adequate size and strength to prevent the TV from being accidentally tipped over, pushed off, or pulled off. This could cause personal injury and/or damage the TV. Refer to the Important Safety Instructions above.

FCC Warning

Class B Computing Device

Information to User

This equipment has been tested and found to comply with the limits for a Class B Digital Device pursuant to part 15 of FCC Rules. These limits are designed to provide reasonable protection against harmful interference in a residential installation. This equipment generates, uses, and can radiate radio frequency energy and, if not installed and used in accordance with the instructions, may cause harmful interference to radio communications. However, there is no guarantee that interference will not occur in a particular installation. If this equipment receives interference while off and on, the user is encouraged to try to correct the interference by one or more of the following measures:

- 1) Reorient or relocate the receiving antenna.
- 2) Increase the separation between the equipment and TV.
- 3) Connect the equipment into an outlet on a circuit different from that to which the TV is connected.
- 4) Consult the dealer or an experienced radio/TV technician for help and for additional suggestions.

The user may find the following booklet prepared by the Federal Communications Commission helpful: "How to Identify and Resolve Radio - TV Interference Problems". This booklet is available from the US Government Printing Office, Washington, D.C. 20402, Stock No. 004-000-00345-4.

FCC Warning

The user is cautioned that changes or modifications not expressly approved by the manufacturer could void the user's authority to operate the equipment.

NOTE: In order for an installation of the product to maintain compliance with the limits for a Class B Device, shielded cables must be used.

TABLE OF CONTENTS

INTRODUCTION

Safety Precautions	1
Specifications	3
Feature Descriptions	4
Front and Rear Unit Profiles	5
Remote Control Features	8

INSTALLATION

Connecting the Antenna	9
Installing the Remote Control Batteries	9
Connecting A/V Equipment	10
Input from Device to TV	10
Output from TV to Device	10

FUNCTIONS & FEATURES

Turn On/Off	13
Basic Functions	13
Function Selection Menus	13
Useful Remote Control Features	16

ADDITIONAL FEATURES

Programming the Remote Control	18
--------------------------------	----

TROUBLESHOOTING GUIDE 22

LIMITED UNITED STATES WARRANTY 23

SPECIFICATIONS

MODEL	PF2020	PF2030	PF2720	PF2730	PF3220	PF3230
Television System	NTSC-M					
Channel Coverage	VHF 2-13, UHF 14~69					
Cable TV Coverage	Mid Band (A-8~A-1, A~I)/Super Band (J~W) Hyper Band (AA~ZZ, AAA, BBB)/Ultra Band (65~94, 100~125)					
Channels Preset	181					
Antenna Input	75 ohm (unbalanced)					
Screen Dimensions	15.98x12.01 in 406x305 mm		21.26x 15.94 in 540x405 mm		25.20x 18.82 in 640x478 mm	
Audio Output	2W+2W		5W+5W		5W+5W	
Power Source	~120Vac 60Hz					
Unit Weight	55lbs. (25kg)		97.9lbs. (44.5kg)		156lbs. (71kg)	
Unit Dimensions	23.03x18.14x19.09 in. 585x461x485mm		29.09x22.83x19.29 in. 739x580x490mm		33.70x26.34x22.05 in. 856x669x560mm	
Packaged Dimensions	25.79x21.02x22.24 in. 655x534x565mm		33.07x26.38x23.43in. 840x670x595mm		40x30.55x27.76in. 1016x776x705mm	
Power Consumption	100W		135W		170W	

Instruction Manual

Feature Descriptions

181 Channel Tuner - total number of channels the TV can receive: 2-69 in Air mode, or 1-125 in Cable mode

AV Input (Rear) - standard composite input designed for use with A/V devices, such as a VCR or DVD player

AV Input (Side) - input designed for infrequent use, such as with a camcorder or video game unit

AV Output (Rear) -output signals from TV to devices such as a VCR

S-Video Input - input designed for greater clarity and sharpness; also known as S-VHS

DVD Input (Rear) - standard input designed for use with DVD player

RF IN Jack - standard coaxial antenna jack

Channel Recall - instant return to the last channel viewed

Closed Caption Display - feature that displays the closed captions or text of a TV broadcast

Parental Control - feature that all parents to block out selected type of programming

Screen Size - the diagonal size of the TV screen

Selectable Picture Modes - preset standards for TV display: User, Normal, Movie, and Sports

Selectable Sound Modes - preset standards for TV sound: User, Normal, Speech, Music and Movie

Trilingual On Screen Display (OSD) - TV's on screen display, can be either English, French, or Spanish

MTS Stereo/Video Stereo- stereo sound for superior TV viewing experience

Favorite Channel -used to set favorite channels

Channel Label -used to label channels

Full -used to switch the TV between Wide and Normal modes

On/Off Timer - feature that allows the user to set a timer to turn on/off the TV and tune the TV to a preset channel at preset time

FEATURES	PF2020	PF2030	PF2720	PF2730	PF3220	PF3230
181 Channel Tuner	•	•	•	•	•	•
AV Input (Rear)	2	2	3	3	3	3
AV Input (Side)	1	1	1	1	1	1
S-Video Input	1	1	1	2	1	2
DVD Input (Rear)	1	1	1	1	1	1
AV Output (Rear)	1	1	1	1	1	1
Screen Size	20"	20"	27"	27"	32"	32"
Pure Flat CRT	•	•	•	•	•	•
Universal Remote Control	•	•	•	•	•	•
Auto Program	•	•	•	•	•	•
Channel Recall	•	•	•	•	•	•
Closed Caption	•	•	•	•	•	•
Parental Control	•	•	•	•	•	•
Picture Modes	•	•	•	•	•	•
Trilingual OSD	•	•	•	•	•	•
Sound Modes	•	•	•	•	•	•
MTS Stereo/AV Stereo	•	•	•	•	•	•
Favorite Channel	•	•	•	•	•	•
Channel Label	•	•	•	•	•	•
Full	•	•	•	•	•	•
On/Off Timer	•	•	•	•	•	•
Sleep Off/Auto Off without Signal in TV Mode	•	•	•	•	•	•
AVC (Automatic Volume Control)	•	•	•	•	•	•
3 Lines Comb Filter	•	•	•	•	•	•
VSM	—	•	—	•	—	•
Color Temp Control	•	•	•	•	•	•
X-Ray Protection	•	•	•	•	•	•
Blue Back On/Off	•	•	•	•	•	•
Digital Geometric Correction	•	•	•	•	•	•
Child Lock	•	•	•	•	•	•
Black Level Stretch	•	•	•	•	•	•
Automatic White Balance Adjustment	•	•	•	•	•	•

Front and Rear Unit Profiles

Front panel

PF2020/PF2030

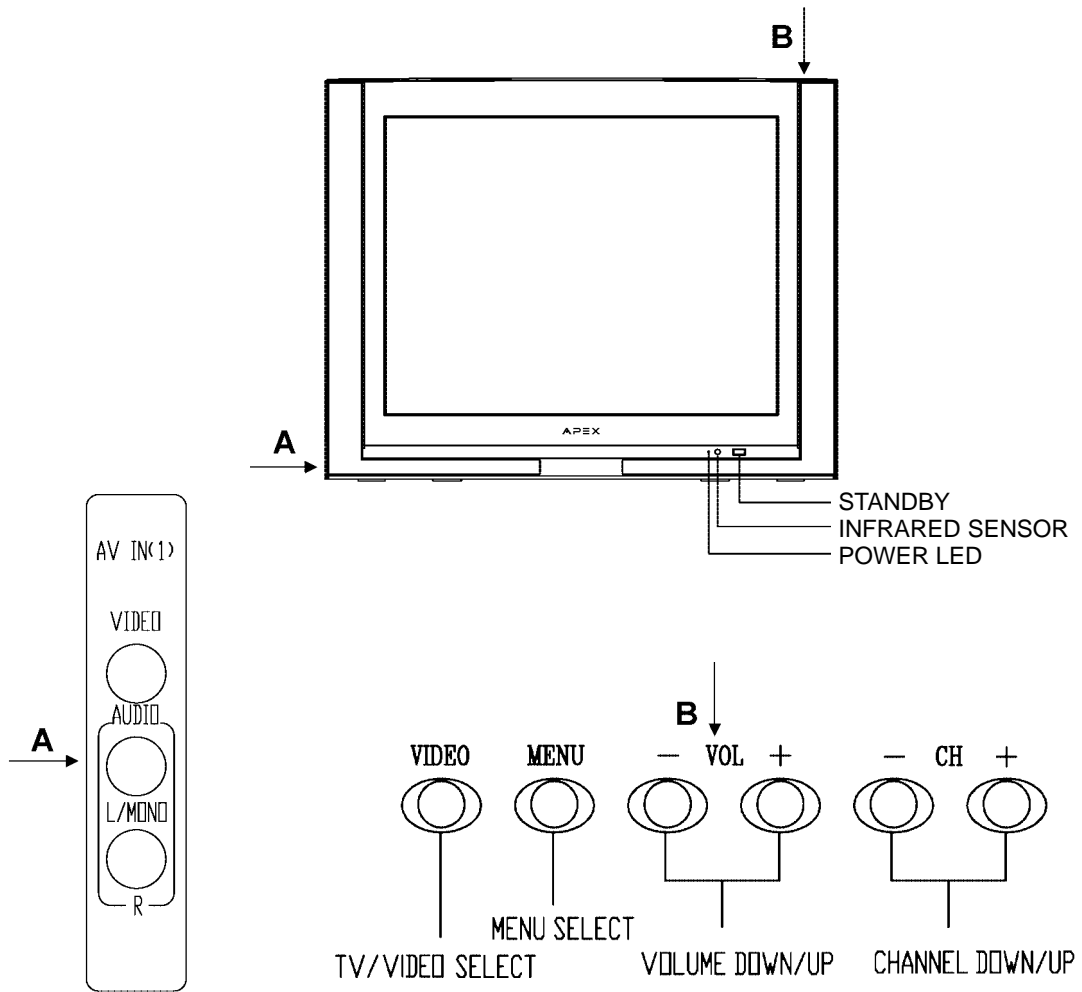

Rear panel

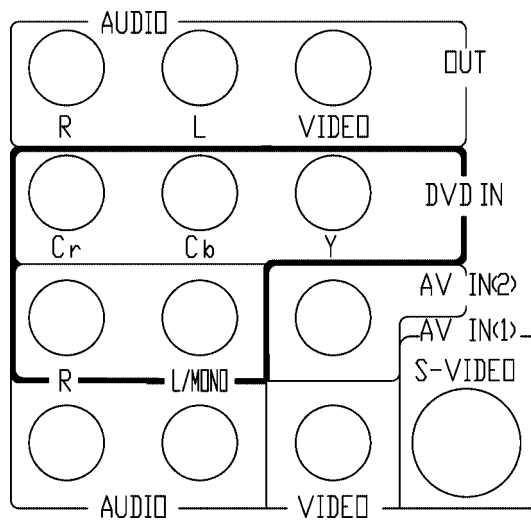

Front and Rear Unit Profiles (continued)

Front panel

PF2720/3220

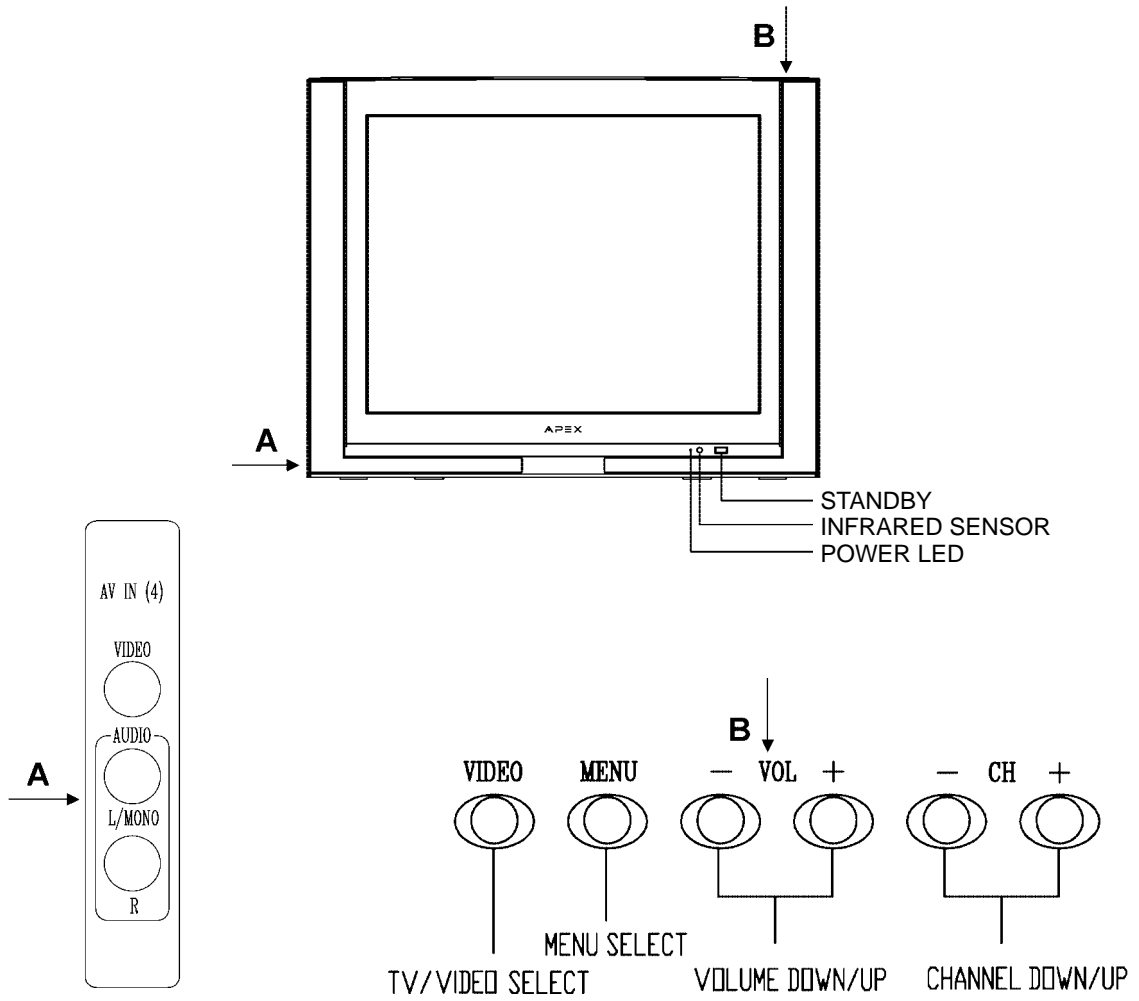

Rear panel

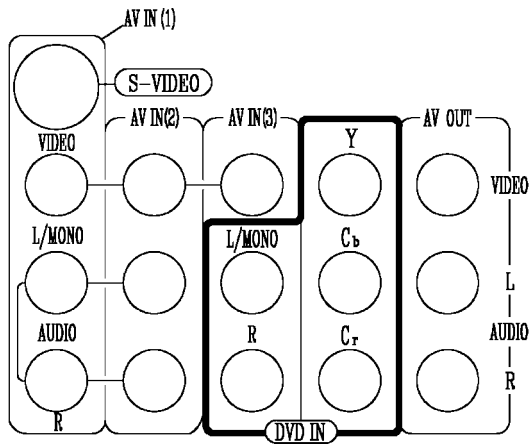

Front and Rear Unit Profiles (continued)

Front panel

PF2730/3230

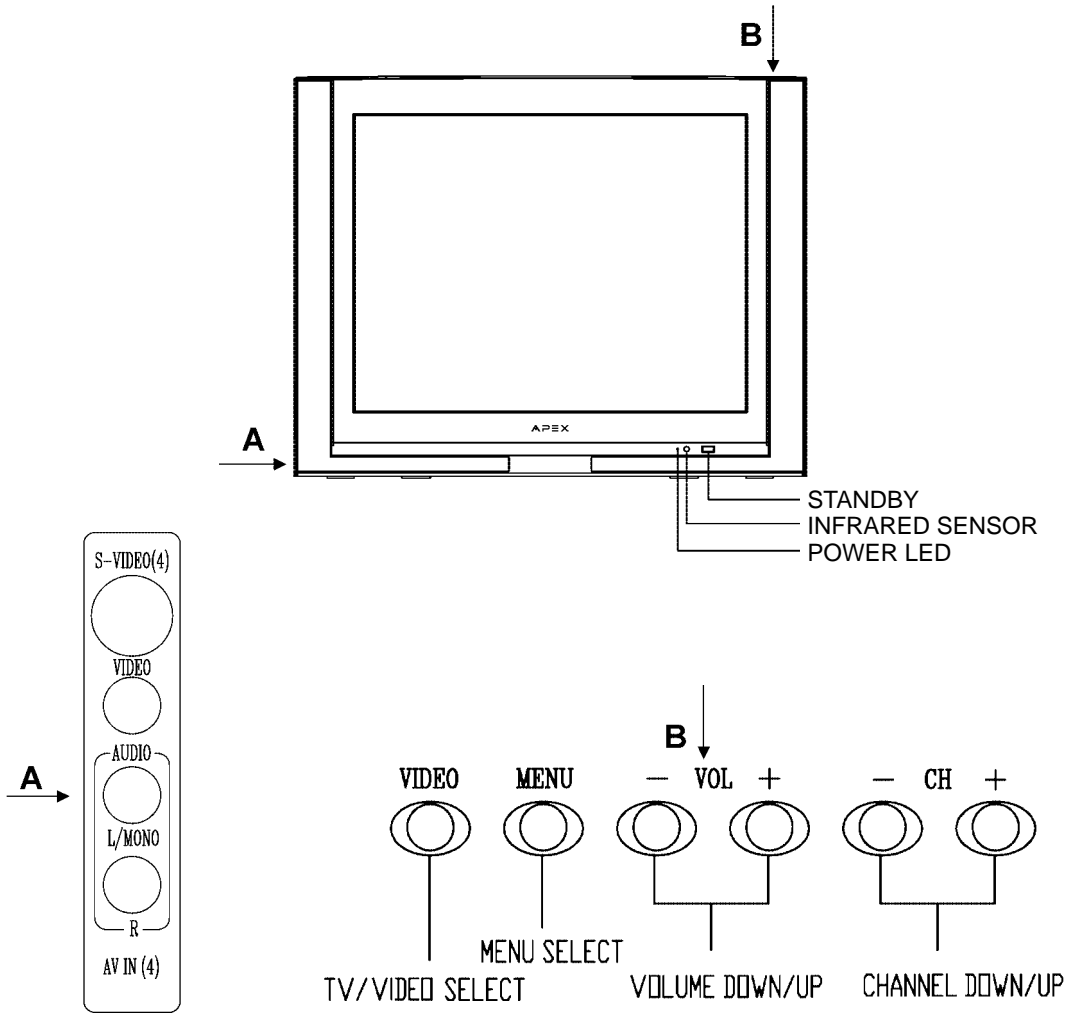

Rear panel

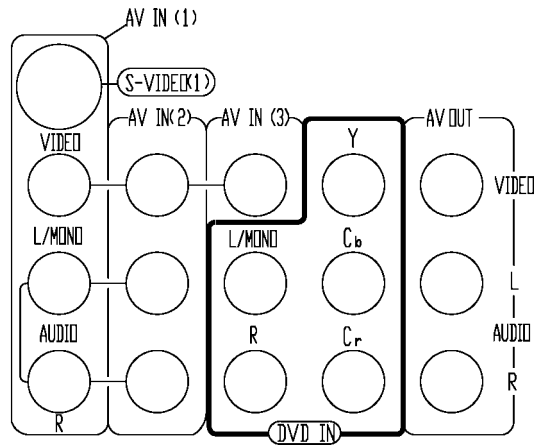

Remote Control Features

Led	Indicator light
Set	Used for programming the remote control
Video	Cycles through the Video/TV modes
Picture	Selects the various Picture Modes
Arrows	Used to navigate the TV menus
CH + / -	Used to change the current channel
Display	Brings up the TV/Video display
Function	Used for child lock
MTS/SAP	Selects the MTS Stereo modes among Mono, Stereo and SAP
CC	Activates Closed Captioning
Full	Switches the TV between Wide and Normal modes
Favorite	Sets favorite channels
Standby	Turns on/off the TV
Keypad	Used to select channels by number
TV, DVD/VCR, SAT/CAB, AUX switch	Determines the equipment controlled by the remote
Menu	Accesses the main menu
Sound	Selects the various Sound modes
Enter	Confirms selections or accesses sub menus
VOL + / -	Used to adjust the volume level
Sleep	Activates/Deactivates the sleep timer
Mute	Mutes or restores the TV volume
Recall	Returns to the last channel viewed
Scan	Scans all active channels
Label	Used to label channels

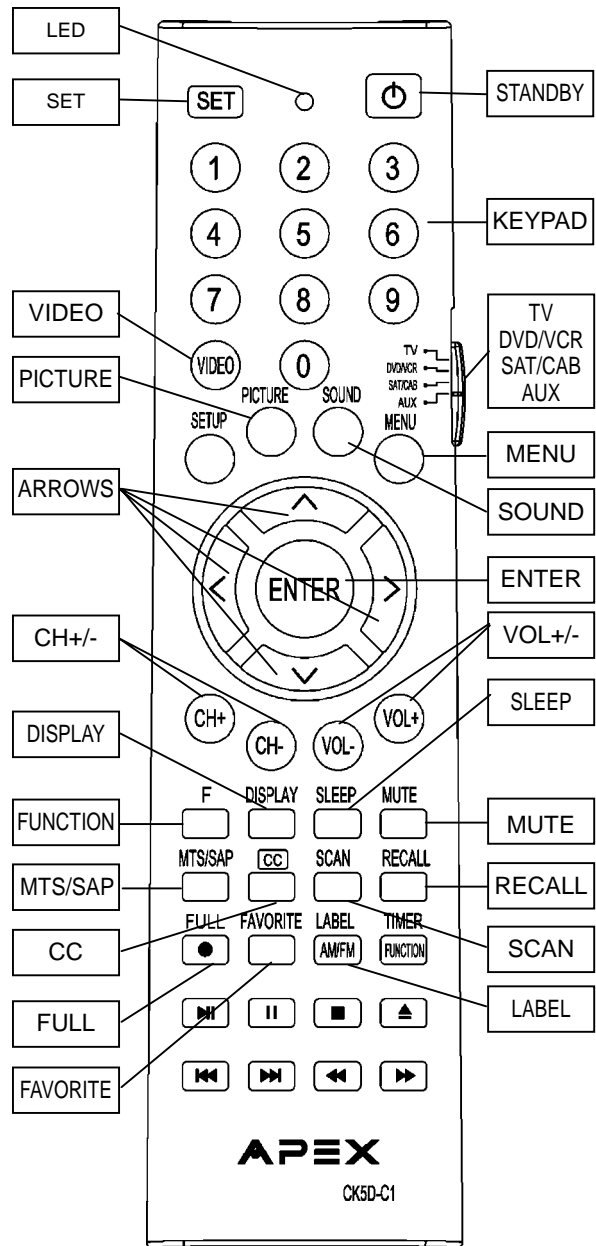

INSTALLATION

- Please read the safety instructions in this manual completely before installation.
- Install your TV in an area where direct sunlight will not fall upon the screen.
- Soft, indirect light is best for television viewing.
- Allow enough space (at least 4 in.) between the TV and any walls or enclosures for proper ventilation.
- Optimum television viewing distance is 3-5 times the screen's size.

Auto-Degaussing

Color television can be easily affected by magnetism, which shows as color distortion on the screen. If your TV is affected by nearby magnetic components or appliances, turn it off for a few minutes. The built-in auto-degaussing circuit will eliminate the magnetic interference.

Connecting the Antenna

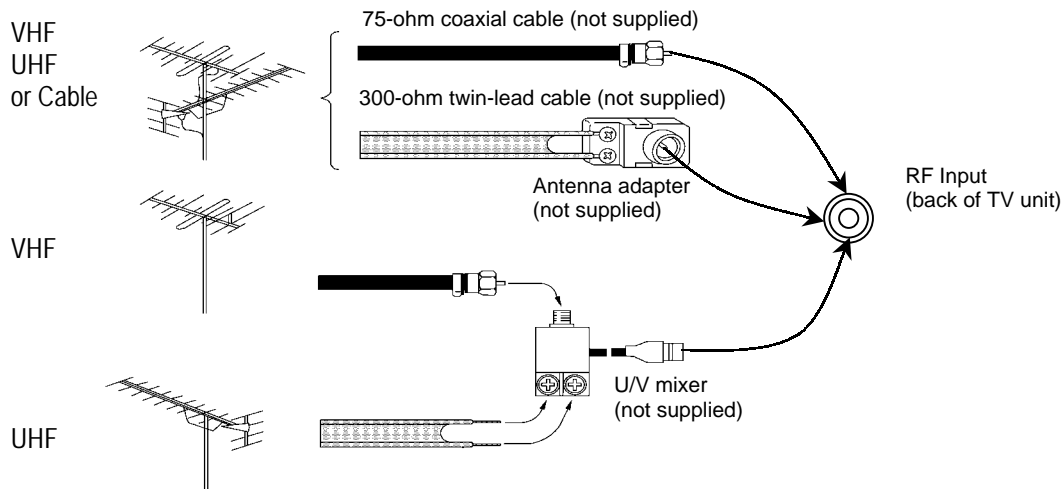

Notes:

1. It is recommended that a 75 ohm coaxial cable be used in order to eliminate interference and noise which may occur due to nearby radio transmissions.
2. The antenna cable should not be tied together with other wiring.
3. Set up a lightning rod and check it regularly when an outdoor antenna is used.

Installing the Remote Control Batteries

1. Remove the battery compartment lid.
2. Insert two AAA batteries (included). Make sure the positive (+) and negative (-) polarities are correctly aligned.
3. Reattach the battery lid.

Notes:

1. Alkaline batteries are recommended for longer life.
2. Always replace both batteries at the same time.
3. Do not expose batteries to fire or break them open.
4. To avoid battery leakage, remove batteries from the remote control when it is not being used for a long period of time.
5. If the remote control can't control the TV properly after new batteries installed, remove the batteries from the remote control and hold down the F key for over 5 seconds. Insert the batteries and try again.

INSTALLATION (continued)

Connecting A/V Equipment

PF2020/PF2030

The following are diagrams showing basic instructions for attaching external equipment, like a VCR or DVD player, to your TV set. Please refer to operation manuals of external audio/video equipment that will be connected to your set for additional instructions. PLEASE TURN OFF ALL POWER BEFORE CONNECTING DEVICES TOGETHER.

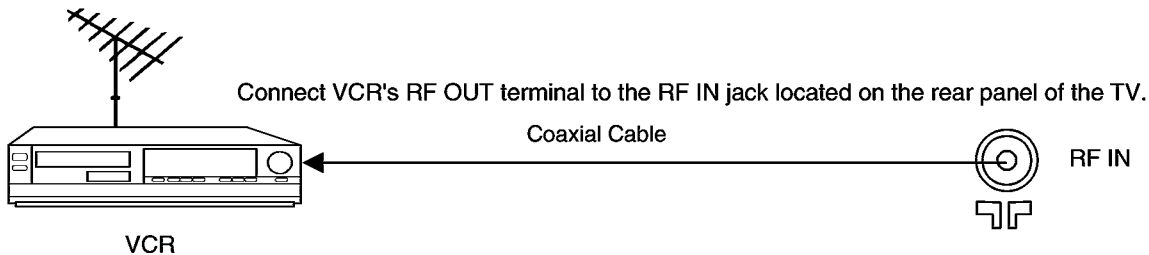

Input from Device to TV

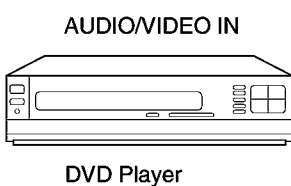

DO NOT use the DVD IN terminals and AV IN (2) terminals at the same time.
DO NOT connect side AV IN(1), rear AV IN(1) and S-Video terminals at the same time. Use only one of the three.
With DVD signal input, there is no DVD video output. Also, remember to connect the audio cables when using S-Video and DVD terminals.

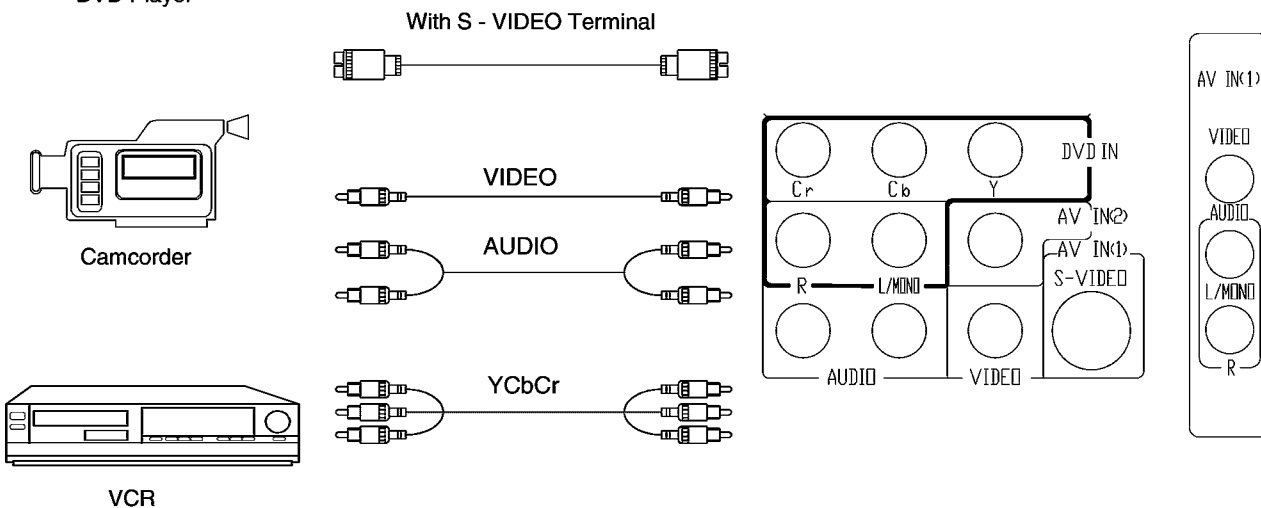

Output from TV to Device

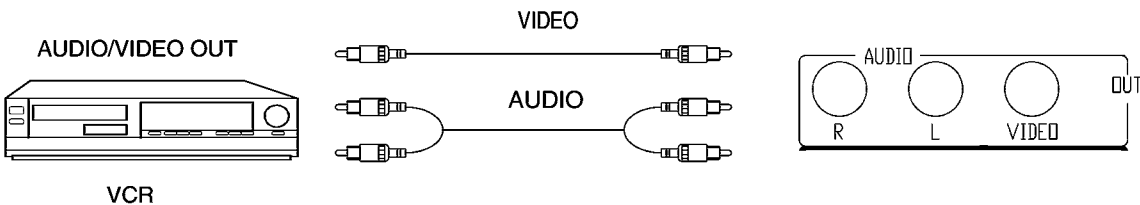

The side terminals may be easier to use with a camcorder. The connections are identical.

INSTALLATION (continued)

Connecting A/V Equipment (continued)

PF2720/PF3220

The following are diagrams showing basic instructions for attaching external equipment, like a VCR or DVD player, to your TV set. Please refer to operation manuals of external audio/video equipment that will be connected to your set for additional instructions. PLEASE TURN OFF ALL POWER BEFORE CONNECTING DEVICES TOGETHER.

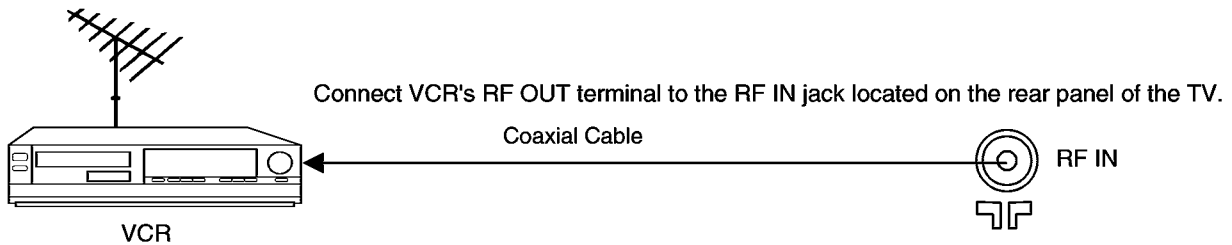

Input from Device to TV

DO NOT use the DVD IN terminals and AV IN(3) terminals at the same time.
DO NOT connect both AV IN(1) and S-Video terminal. Use only one of the two. With DVD signal input, there is no DVD video output. Also, remember to connect the audio cables when using S-Video and DVD terminals.

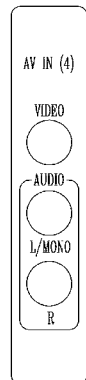
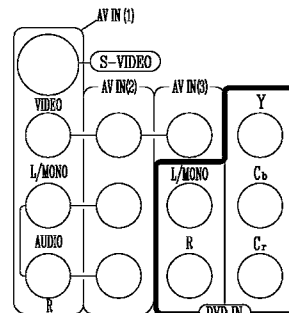
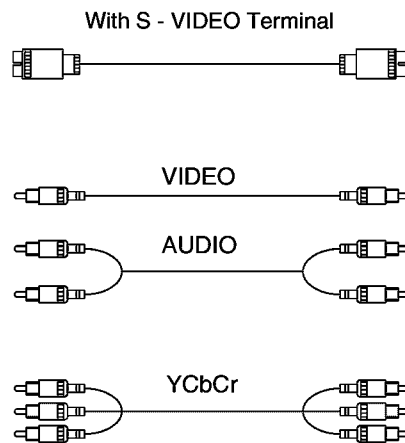
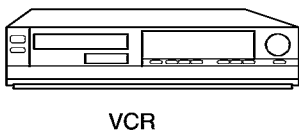
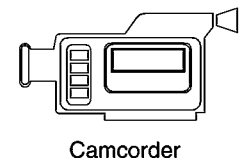
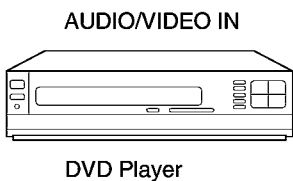

Output from TV to Device

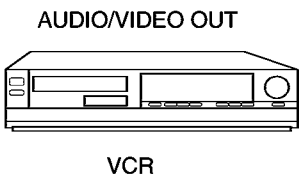

The side terminals may be easier to use with a camcorder. The connections are identical.

INSTALLATION (continued)

Connecting A/V Equipment (continued)

PF2730/3230

The following are diagrams showing basic instructions for attaching external equipment, like a VCR or DVD player, to your TV set. Please refer to operation manuals of external audio/video equipment that will be connected to your set for additional instructions. PLEASE TURN OFF ALL POWER BEFORE CONNECTING DEVICES TOGETHER.

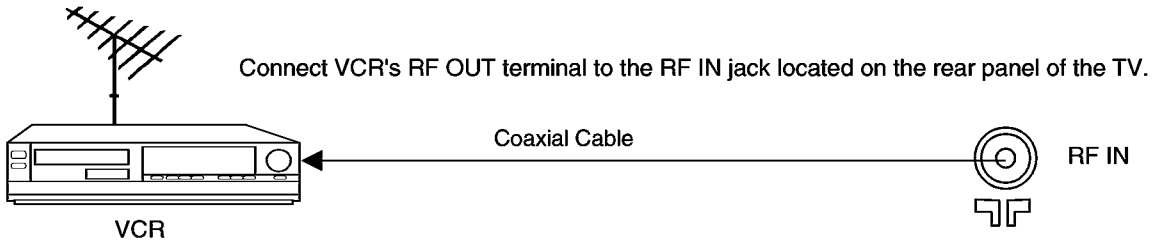

Input from Device to TV

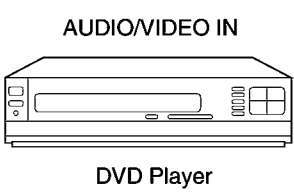

DO NOT use the DVD IN terminals and AV IN(3) terminals at the same time.
DO NOT connect both AV IN(1) and S-VIDEO(1) terminal. Use only one of the two. DO NOT use the AV IN(4) and S-VIDEO(4) terminals at the same time. With DVD signal input, there is no DVD video output. Also, remember to connect the audio cables when using S-Video and DVD terminals.

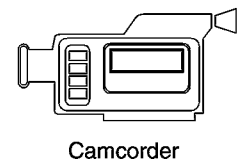

With S - VIDEO Terminal

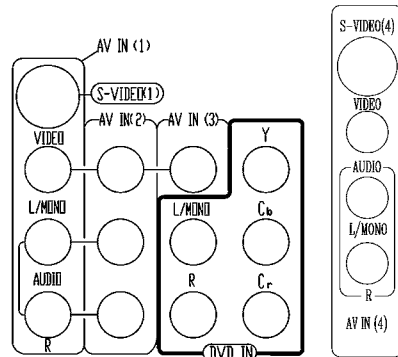
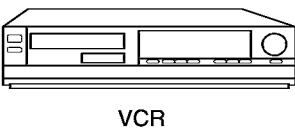
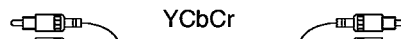
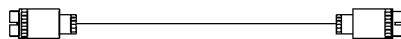

Output from TV to Device

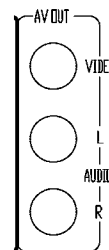
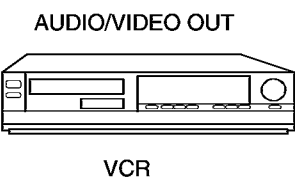

The side terminals may be easier to use with a camcorder. The connections are identical.

FUNCTIONS & FEATURES

Turn On/Off

1. Turn On

Plug in the supply cord, and the TV should enter the Standby mode. Pressing the STANDBY on the remote control or on the TV can turn on the TV. Also, the power indicator light on the TV will come on.

2. Standby (Soft Off)

While the TV is on, press the STANDBY key. This will put the TV in Standby or soft off mode. The power indicator light on the TV set will turn off.

3. Auto off when no signal received

The TV set will automatically enter into Standby mode when the following conditions are met.

- 1) TV is in antenna mode.
- 2) Current channel has no signal.
- 3) No key is pressed within 15 minutes.

Basic Functions

Changing the Channel

While in Tuner mode, press the CH +/- keys to change the channel, or use the numeric keypad to enter a new channel.

Adjusting the Volume

To increase or decrease the volume, press the VOL +/- keys. The volume adjustment ranges from 0 to 100.

Muting the Volume

To mute the volume, press the MUTE key. To restore the volume, press MUTE again.

Function Selection Menus

All Function menus can be accessed by pressing the MENU key on the remote control or the top panel. Navigation of the menu be done with the arrows and ENTER keys on the remote and - CH + and - VOL + keys on the top panel. Exit with the MENU key.

Video Setting Menu

This menu allows you to adjust the various picture settings.

Access

From the Main menu screen, press the left or right arrow key until *Video Setting* is highlighted. Then the Video Setting menu is displayed.

Picture Control: Press the up or down arrow key to select *Picture Control* and right arrow key or ENTER key to access the sub menu. Use the up or down arrow key to move between the various settings, and the left or right arrow key to adjust them.

- CONTRAST:** 0 (minimum contrast) to 100 (maximum contrast)
- BRIGHTNESS:** 0 (dimmiest) to 100 (brightest)
- COLOR:** 0 (minimum color) to 100 (maximum color)
- SHARPNESS:** 0 (minimum sharpness) to 100 (maximum sharpness)
- TINT:** -50 (more purplish) to +50 (more greenish)
- COLOR TEMP:** Cool, Standard or Warm

Picture Mode: Use the left or right arrow key to select among User, Normal, Movie and Sports.

Auto Black Lvl: This feature improves gradation of picture. Press the left or right arrow key to set it On or Off after *Auto Black Lvl* is highlighted.

VSM: This feature allows you to improve sharpness. Press the left or right arrow key to set it On or Off after *VSM* is highlighted.

Note:

This function is not available for PF2020, PF2720 and PF3220. For PF2030, PF2730 and PF3230, it doesn't work in the DVD mode.

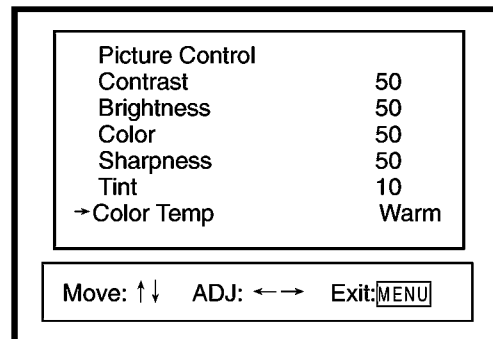
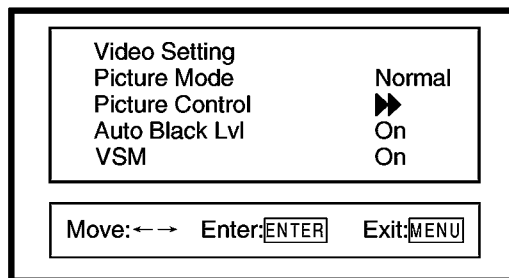

FUNCTIONS & FEATURES (continued)

Function Selection Menus (continued)

Audio Setting Menu

This menu allows you to adjust the various audio settings.

Access

From the Main menu screen, press the left or right arrow key until *Audio Setting* is highlighted. Then the Audio Setting menu is displayed.

Sound Control: Press the up or down arrow key to select *Sound Control* and right arrow key or ENTER key to access the sub menu. Use the up or down arrow key to move between the various settings, and the left or right arrow key to adjust them.

BASS: 0 (less Bass) to 100 (more Bass)

TREBLE: 0 (less Treble) to 100 (more Treble)

BALANCE: -50 (Left Dominance) to +50 (Right Dominance)

SURROUND: Off, On

AVC: Off, On

Sound Mode: Use the left or right arrow key to select among User, Normal, Movie, Speech and Music.

AVC: This feature will automatically control volume. Highlight *AVC* and use the left or right arrow key to set it On or Off.

Surround: This feature offers dynamic acoustic effect. Highlight *Surround* and use the left or right arrow key to set it On or Off.

Channel Setting Menu

Access

From the Main menu screen, press the left or right arrow key until *Channel Setting* is highlighted. Then the Channel Setting menu is displayed. Use the up or down arrow key to move between the various settings, and the left or right arrow key to adjust them.

Favorite Channel: This feature allows you to set favorite channels. Use the up or down arrow key to highlight *Favorite Channel*, and the right arrow or ENTER key to call up the sub menu.

1. When *Mode* is set to *Auto*, use the numeric keypad to directly enter the favorite channel numbers. The TV only stores the last five effective channels.

2. When *Mode* is set to *Manual*, The TV stores favorite channels respectively in *Air* and *Cable* mode. Use the up or down arrow key to move between the various selections, and the left or right arrow key or numeric keypad to select the favorite channel numbers. Press the ENTER key to shift the TV to the selected channel.

Erase/Add: This feature allows you to add or remove the channel currently displayed on screen from the "active channel list." Active channel list is the list of channel that is available by pressing the CH+/- keys. Use the left or right arrow key to select *Add* or *Erase*.

Antenna: This feature sets the TV tuner to an Air antenna or a Cable antenna. Please use *Air* mode when using an over-the-air antenna; use *Cable* mode for a cable hookup. Use the left or right arrow key to select between the two options.

Auto Program: This feature will setup the Active channel list for the user. The list will include only the channels with a signal detected. Press the right arrow key to begin and the left arrow key to stop the process.

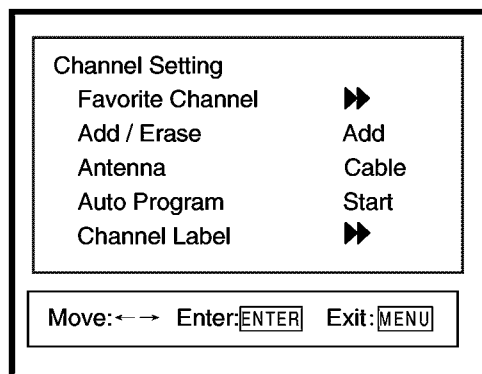
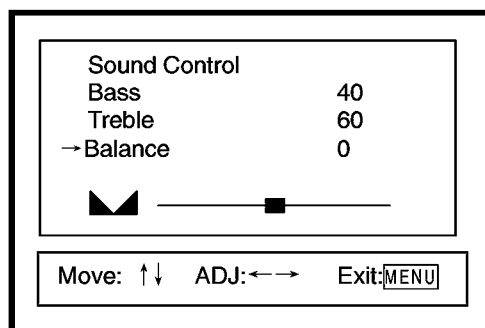
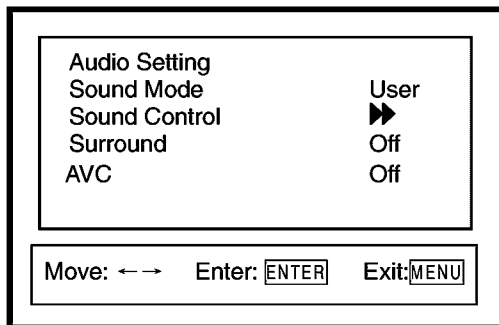

FUNCTIONS & FEATURES (continued)

Function Selection Menus (continued)

Channel Label: This feature allows you to label channels in up to 5 characters. Use the up or down arrow key to highlight *Channel Label*, and the right arrow key to call up the sub menu.

1. Use the up or down arrow key to choose *Channel*, and the left or right arrow key to select the channel (the current channel is default).
2. Choose *Name* in the same way as above. Use the left or right arrow key to select one of the characters (including 0-9, &, /, - and A-Z) cyclically, and the up or down arrow key to move the cursor.

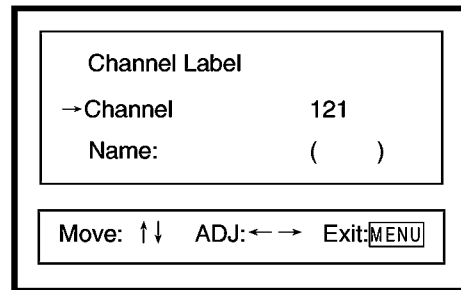

Notes:

1. If a channel has been labeled, the TV will display the corresponding channel name when shifted to the channel.
2. In the AV mode, channel setting menu is not available.

Timer Setting Menu

This menu allows you to set a time for the TV to turn on or off and tune the TV to a specific channel at preset time.

Access: From the Main menu screen, press the left or right arrow key until *Timer Setting* is highlighted. Then the Timer Setting menu is displayed. Use the up or down arrow key to move between the various settings, and the left or right arrow key to adjust them.

Notes:

1. Only after you set the current time, can you set On Time, On Channel and Off Time.
2. On/off time can be set to one of the three modes: Off, Once and Always.

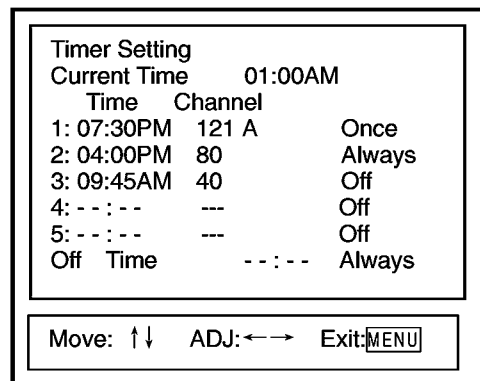

Parental Guide Setting Menu

This feature allows parents to block certain programs from being viewed, based on the programs' rating.

Access: From the Main menu screen, press the left or right arrow key until *Parental Guide Setting* is highlighted. In order to access this menu, you must first enter a pass code. The factory default is **1225**.

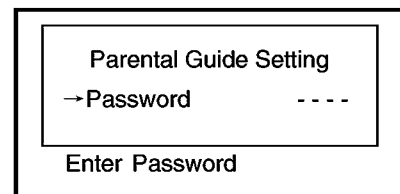

Parental Guide: Only with *Rate Setting On*, are *TV-Rating* and *MPAA-Rating* displayed. Press the up or down key to move between the two items and right arrow key to access the TV-Rating or MPAA-Rating grid.

TV-Rating: Using the up or down arrow key to navigate between the ratings, press the left or right arrow key to select *U* or *B*. A *U* indicates a rating which is unblocked and a *B* indicates a rating which is blocked.

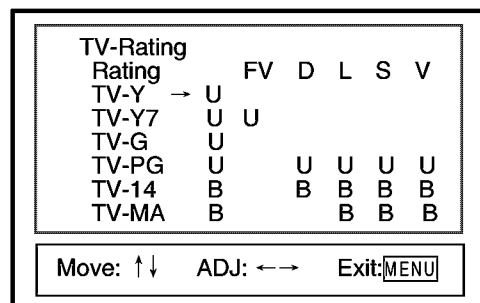
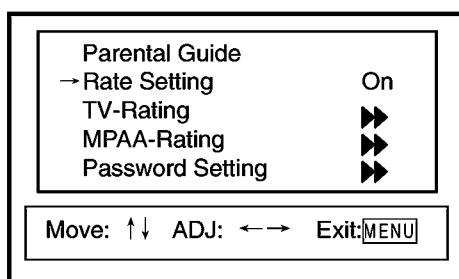

FUNCTIONS & FEATURES (continued)

Function Selection Menus (continued)

MPAA-Rating: Use the up or down arrow key to navigate between the ratings. Pressing the MENU key with a rating highlighted will block that particular rating from being shown on this TV. A *U* indicates a rating which is unblocked and a *B* indicates a rating which is blocked. Please note that blocking a lower rating (for example, PG) will block all higher ratings (PG-13, R, NC-17, X.)

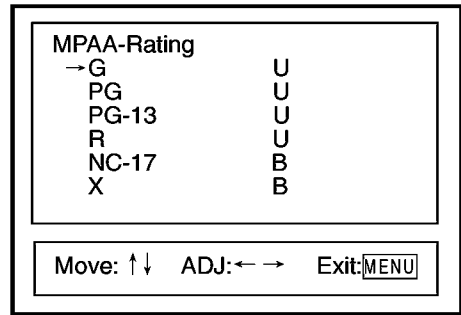

Age	Defined as	Contents	Defined as
TV - Y	All Children	FV	Fantasy Violence
TV - Y7	Directed to Older Children (over 7)	D	Sexual Dialogue
TV - G	General Audience	L	Adult Language
TV - PG	Parental Guidance Suggested	S	Sexual Situations
TV - 14	Parents Strongly Cautioned	V	Violence
TV - MA	Mature Audience Only		

Password Setting: This feature allows you to change the access code for the Parental menu. Press the right arrow or ENTER key to access the sub menu. Then enter the new password using the numeric keypad. If the right number was entered, "New Password OK!" are displayed on the screen. If not, "Invalid! Enter again!" are displayed.

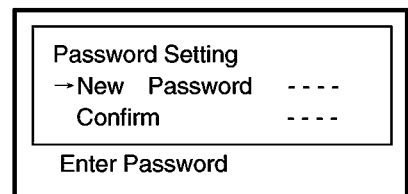

Setup Menu

From the Main menu screen, press the left or right arrow key until *Setup* is highlighted. Then the Setup menu is displayed. Use the up or down arrow key to move between the various selections in this menu.

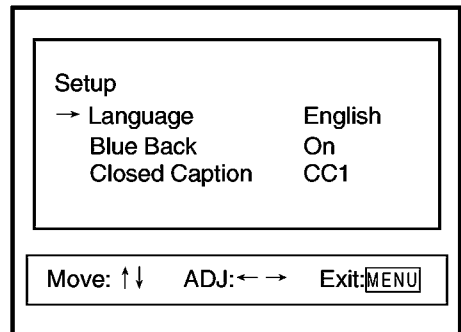

Language: This feature allows you to pick a language used for the on screen display (OSD). Use the left or right arrow key to select the language of your choice – English (Eng.), French (Fra.), or Spanish (Esp.).

Blue Background: This feature gives you the option to display a blue background on the TV screen when there is no signal present. Use the left or right arrow key to toggle between on and off.

Closed Caption: Closed caption is a feature that allows your TV set to display closed caption signal on screen. It also allows you to display teletext signal. There is nine different setting for closed caption. You can set it to one of the 4 Closed Caption settings (CC1-4), one of the 4 Text settings (T1-4), or set this feature to off (CCD/Text off).

Useful Remote Control Features

Display

This key allows you to display the current information of the TV screen (channel, antenna mode, time, video, etc.). Display disappears in about 6 seconds.

0-9

Press the 0-9 keys to enter channel numbers directly (2-69 in the Air mode or 1-125 in the Cable mode).

- 1.To choose a one-digit channel number, press the corresponding Number key directly to switch to the desired channel number in about 3 seconds.
- 2.To choose a two-digit channel number, enter a first-digit and then a second digit within 3 seconds.
- 3.To choose a three-digit channel number, enter a first-digit, second-digit and third-digit respectively in the way mentioned above.

Scan

Press the SCAN key to display the current channel No. and Scan mode (Scan On or Scan Off). Press the key firstly to display *Scan Off* on the screen. Press the key secondly to display *Scan On* on the screen. And the TV begins to scan through all active channels. Upon completion, the TV automatically returns to the current channel and shifts to the Off mode. Pressing any key can interrupt scanning.

FUNCTIONS & FEATURES (continued)

Useful Remote Control Features (continued)

Picture

Your TV has factory preset picture modes that allow you to optimize your TV viewing. To activate these picture modes, press the PICTURE key, and you can choose among User, Normal, Movie and Sports.

Sound

Press the SOUND key repeatedly, and you can choose among User, Normal, Movie, Speech and Music.

Recall

This key will allow you to return to the last channel you were viewing. Pressing it again will return you to the channel you just left.

Favorite

This key will display the favorite channel if a favorite channel is set.

Full

This key will switch the TV between Wide and Normal modes.

CC

Pressing the CC key will activate the currently selected Closed Caption or Text. Press the key repeatedly to select another mode in turn.

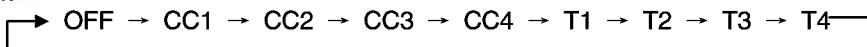

Video

This key allows you to toggle between antenna mode and different video modes cyclically:
For PF2730 and PF3230: TV -> Video1(S-VHS1) -> Video2 -> Video3 -> Video4(S-VHS4) -> DVD
For PF2720 and PF3220: TV -> Video1(S-VHS) -> Video2 -> Video3 -> Video4 -> DVD
For PF2030 and PF2020: TV -> Video1 -> Video2 -> S-VHS -> DVD

Child Lock

The Child Lock feature prevents unauthorized viewing of the TV. To activate, press and hold the F key, and then press MUTE. This will lock out all remote functions (except for Standby) and *Child Lock On* will be displayed for 6 sec. You can see only the current channel with normal picture and sound. With Child Lock set before turn-off, no picture and no sound are available from the TV if the TV is turned on again, but only *Child Lock On* displayed. To unlock the TV, press and hold the F key and press MUTE. This will unlock the TV. Please note that the only way to activate or deactivate the Child lock feature is via remote control - please insure that it is stored securely.

Sleep

Press the SLEEP key repeatedly to switch the TV to one of the following modes cyclically: Off -> 15 -> 30 -> 45 -> 60 -> 90 -> 120 -> 150 -> 180 (Unit: Minute). With Sleep Off set, press the SLEEP key firstly to display the remaining time and press it secondly to re-set the Sleep Off time.
"TV will turn off soon!" will be displayed on the screen one minute before the Sleep timer runs out.

MTS/SAP

In the TV mode, the TV can automatically identify MTS stereo modes to one of Mono, Stereo, Stereo/SAP and Mono/SAP. Under no signal condition, the audio mode does not appear on the screen. When receiving signals from external equipment in the Video mode, Stereo is defined as default. Press the MTS/SAP key repeatedly to set Input to Stereo, L or R. Press the key firstly after OSD disappears to display the auto-identified MTS mode. Press it again before the OSD disappears to compulsorily set another MTS mode.

Signal Received	Press MTS/SAP key
STEREO	STEREO, MONO
MONO/SAP	SAP, MONO
STEREO/SAP	STEREO, SAP, MONO
MONO	MONO

Label

This key functions only in the TV mode. For an explanation of this feature, please see page 15.

ADDITIONAL FEATURES

Programming the Remote Control

1. Set the **TV, DVD/VCR, SAT/CAB, AUX** switch to the device you want to control
2. To program the remote control
 - 1) Press and hold the SET key for over 3 seconds until the LED indicator on the remote control turns off. Release the key and the LED will light again. The remote control is now in the PROGRAMMING mode.
 - 2) Use the 0-9 keys to enter three-digit code number for your device. If the right code number was entered, the LED blinks three times. If you enter a code not listed below, or you press any other keys than STANDBY and ENTER, the LED turns off.
 - 3) "**TV**": To control TV . "**DVD/VCR**": To control DVD, VCR, LD and CD. "**SAT/CAB**": To control satellite receiver and cable box. "**AUX**": To control all the above appliances
3. To search codes
 - 1) Press and hold the SET key for over 3 seconds until the LED indicator on the remote control turns off. Release the key and the LED will light again. The remote control is now in the PROGRAMMING mode.
 - 2) Press the STANDBY key and code search begins.

3)

Press	Description
Up or down arrow key	The remote control searches codes upwards or downwards. Each time you press the up or down arrow key, the code number for the STANDBY key increases or decreases by 1; or the code number automatically increases or decreases by 1 per 3 seconds. Try each code separately until you find the one that works. If not after trying all the codes, LED blinks rapidly eight times and search stops.
ENTER	If the desired code number is found, press the ENTER key to confirm the current searched code number for your device. Then LED blinks rapidly three times to exit from search.
Other keys	LED blinks rapidly eight times and search stops.

4) When the **TV, DVD/VCR, SAT/CAB, AUX** switch is set to the "AUX" position, the remote control can not search code.

4. To check the current code number

- 1) Press and hold the SET key for over 3 seconds until the LED indicator on the remote control turns off. Release the key and the LED will light again. The remote control is now in the PROGRAMMING mode.
- 2) Press the ENTER key.

3) You may read the code number according to the LED display status as follows.

Code Number			LED Display Status		
First-digit	Second-digit	Third-digit	First-digit	Second-digit	Third-digit
0	0	0	Blinks rapidly once	Blinks rapidly once	Blinks rapidly once
1	0	6	Blinks once	Blinks rapidly once	Blinks six times
0	4	3	Blinks rapidly once	Blinks four times	Blinks three times
1	5	0	Blinks once	Blinks five times	Blinks rapidly once

5. To use the REC key

The REC key functions only when it is pressed twice continuously.

Instruction Manual

TV CODES

Brand	Code Number	Brand	Code Number
APEX	157,158,159,160,161,162	Megatron	047
Admiral	001,119	Memorex	003,067,068,115,151
Adventura	120	MGA	004,013,014,015,040,065,067
Aiko	011	Midland	042,110,124
Akai	002	Minutz	041
Alleron	036	Mitsubishi	004,013,014,015,040,065,066,067,097
Amtron	030	Montgomery Ward	068
Anam National	030,133,134,135,154	Motorola	119,154
AOC	003,004,005,136	MTC	004,084
Audiovox	030	NAD	058,059,128
Bell & Howell	001,068,115	NEC	004,070,014,139,154
Belcor	003	Nikko	011
Bradford	030	NTC	011
Brokwood	003	Optimus	128
Candle	003,005,006,120	Optonica	077,119
Celebrity	002	Orion	027,145
Citizen	003,005,006,011,030,084,120,121	Panasonic	042,050,148,150,154
Colortyme	003,005,007,139	Philco	006,008,013,055,056,061,063,069,126,127 152,154
Concerto	003,005	Philips	006,008,013,055,056,061,062,071,072,073,154
Contec/Cony	008,009,030	Pioneer	074,075,122,128,149
Craig	030	Portland	011
Curtis Mathes	000,003,005,010,084,115	Price Club	084
Daewoo	004,005,011,012,098,099,132,141	Prism	042
Daytron	005	Proscan	000,124
Dimensia	000	Proton	008,076,129
Dumont	110	Pulsar	110
Electroband	002	Quasar	042,057,148
Electrohome	013,014,015,154	Radio Shack	000,038,077,115
Emerson	008,016,017,018,019,020,021,022,023,024 025,026,027,028,029,030,031,032,033,034 035,036,037,096,115,121,122,145,154	RCA	000,078,079,080,081,082,124,130,132,141,142
Fisher	038,039,040,115,123	Realistic	038,077,115
Fujitsu	036	Runco	110
Funai	036	Samsung	010,012,014,083,084,140,143
GE	000,015,041,042,043,072,116,117,118, 124,147,154	Sansui	145
Goldstar	004,008,013,014,044,045,046,113	Sanyo	038,039,065,085,123
Gibraltar	110	Scott	017,027,036
Grundy	036	Sears	009,014,036,038,039,040,054,058,059,086,087 123,124,131
Hitachi	008,009,047,048,049,103,104,105,106, 107,108,109,122,137,138	Sharp	022,077,088,089,090,091,095,119
Infinity	050	Signature	001,068,151
Janeil	120	Simpson	006
JBL	050	Sony	002,144,153
JC Penney	000,004,006,015,041,042,046,051,052, 059,072,084,124,140	Soundesign	006,036
JCB	002	Squareview	131
JVC	008,009,042,048,053,054,114,125	Supre-Macy	120
Kawasho	002	Supreme	002
Kenwood	013,014	Sylvania	055,056,061,062,063,069,073,092,126,127,152
Kloss Novabeam	055,056,120,126	Symphonic	131,155
KTV	057,121	Tandy	119
Loewe	050	Tatung	122
Logik	068,151	Technics	042
LXI	000,038,050,058,059,060,115,124	Teknika	009,011,062,067,068,084,151
Magnavox	006,013,050,055,056,061,062,063, 069,073,100,101,102,126,127,152	Tera	129
Majestic	068	Toshiba	038,058,059,084,086,140
Marants	050	Universal	041,072
Marantz	050,064	Victor	054,125
		Viking	120
		Wards	001,017,041,055,056,061,062,068,069,072,073 077,093,094,127,155
		Zenith	110,111,112,146,151

Instruction Manual

DVD CODES

Brand	Code Number	Brand	Code Number
APEX	362,363,364,365,366,367,368,369,370,435,436,437	Philips	347,355,356,357
Aiwa	351	Pioneer	345,350
Hitachi	352	Proscan	349
JVC	348,353	RCA	349
Magnavox	347	Sanyo	358
Mitsubishi	346	Sony	344,359,360
Panasonic	354,361	Toshiba	343

VCR CODES

Brand	Code Number	Brand	Code Number
Admiral	415	Magnavox	385,386,399,403
Aiwa	382,427,428	Marantz	375,376,378,385,399,403,416
Akai	392,421	Marta	418
Amstrad	382	MEI	403
APEX	438	Memorex	373,382,403,415,418,420
ASA	399	MGA	372,387,398,423
Audio Dynamics	376,416	Minolta	384,389
Audiovox	418	Mitsubishi	372,374,387,394,398,400,423
Broksonic	417,419	Motorola	415
Bush	381	MTC	382,420
Calix	418	Mutitech	379,381,382,420
Candle	378,418	NEC	375,376,378,392,394,400,406,416
Canon	403,404	Nikko	418
Capeheart	391	olympus	424
Carver	385	Optimus	415,418
CCE	421	Optonica	388
Citizen	378,379,418,421	Panasonic	377,390,403,407,408
Craig	373,379,418	Pentax	378,384,389
Curtis Mathes	374,378,403,414	Perdio	382
Daewoo	391,405,419,421,422	Philco	385,386,403
Daytron	391	Philips	385,388,399,403
DBX	376,416	Pilot	418
Dimensia	425	Pioneer	376,384,394,400,416
Dynatech	382	Portland	391
Electrohome	372,418,423	Proscan	374,414
Electroponic	418	Quasar	396,397,403
Emerson	372,380,382,387,417,418,419,423	Radio Shack	371,372,373,383,388,415,418,420,423
Fisher	371,373,382,383,393	Radix	418
Funai	419	Randex	418
GE	374,379,403,414	RCA	374,379,384,389,407,414
Go Video	401,402,429	Realistic	382,383,388,403,415,418,420,423
Goldstar	378,418,421	Ricoh	411
Goodmans	381	Salora	398
Gradiente	420	Samsung	379,405
Grundig	399	Sanky	415
Harley Davidson	420	Sansui	376,392,394,395
Harman Kardon	406	Sanyo	373
Hinari	381	SBR	399
Hitachi	382,384,389,392	Schneider	381
Instant Replay	426	Scott	380,387,417,419
JC Penney	375,376,379,389,392,403,406,416,418	Sears	371,373,383,384,389,393,418
Jensen	384,392	Sharp	372,378,423
JVC	375,376,378,392,394,400,416	Shintom	381
Kenwood	375,376,378,392,394,400,416	Sony	409,410,411,412,413
Kodak	418	STS	389
Lloyd	382,420	Sylvania	382,385,386,387,398,403,420
Logik	381	Symphonic	382,420
LXI	418,430,431,432,433,434	Tandy	382

Instruction Manual

VCR CODES

Brand	Code Number	Brand	Code Number
Tashiko	382,418	Victor	376,400
Tatung	375,392,395	Videosonic	379
Teac	375,382,392,420	Video Concepts	376
Technics	390,403	Wards	372,373,379,380,381,382,384,388,389,403,415, 418,420,423
Teknika	382,403,418,420	XR-1000	420
Toshiba	380,383,384,387,398,405	Yamaha	375,376,378,392,406
Totevision	379,418	Zenith	412,413
Vector Research	376,406		

LD CODES

Brand	Code Number	Brand	Code Number
Magnavox	336	Pioneer	342
Panasonic	340,341	Sony	337,338,339

CD CODES

Brand	Code Number	Brand	Brand	Code Number
ADC	317	Luxman		332
ADO	318	Marantz		308,333
Aiwa	300,319	MCS		334
Akai	320	Mitsubishi		335
Denon	322	NEC		307
Dynatech	301	Onkyo		309
Emerson	302	Panasonic		310
Fisher	303,325,326	Pioneer		311
GE	327	RCA		312,324
Hitachi	304	Sears		321
Inkel	328	Sony		313,323
JVC	305,329	Technics		314
Kenwood	306,330,331	Yamaha		315,316

CABLE BOX CODES

Brand	Code Number	Brand	Code Number
ABC	508,509,510,511	Philips	514
ChangHong	500	Pioneer	503,504,517
General Instrument	525	RCA	524
hamiln	541,542,54+5,546,547	Scientific Atlantic	504,505,518,519
Hytex	508	StarCom	511
Jerrold	506,510,511,512,513,520,525,548,549,550	Tocom	509,512
Movie Time	515	TV86	515
NSC	515	United Artists	508
Oak	501,508,516	Viewstar	514,515
Panasonic	502,507,544	Zenith	504,521,522,523

SATELLITE CODES

Brand	Code Number	Brand	Code Number
GE	528,531,532	Panasonic	543
General Electric	526	Philips	536
Hitachi	534,535	Proscan	528,531,532
Hughes	537,538	RCA	528,531,532,540
JVC	533	Sony	529,539
Magnavox	536	Toshiba	527,530

AMPLIFIER CODES

Brand	Code Number	Brand	Code Number	Brand	Code Number
Aiwa	702	Memorex	704	Sony	702,705
ChangHong	700,701	Panasonic	710	Techniques	710
Carver	709	Pioneer	703,704	Toshiba	711
Fisher	709	Proton	708	Victor	706
JVC	706,712	Quasar	710		
Magnavox	708	RCA	707,713		

TROUBLESHOOTING GUIDE

Check the following guide for a possible correction to a problem before contacting customer service.

Check FAQ at our website: www.apexdigitalinc.com.

Symptoms	Correction
No power	<ul style="list-style-type: none"> • Verify the power cable to plug into an outlet with power.
No picture	<ul style="list-style-type: none"> • Verify the connection from the DVD/VCR video output to the TV video input is secure. Then switch TV to the appropriate Video mode. • Verify an antenna cable is securely connected to the RF in jack.
No sound	<ul style="list-style-type: none"> • Connect the audio cables into the terminals securely. • Verify the connection from the DVD/VCR audio output to the TV audio input. Then switch to the appropriate mode on the receiver. Refer to your audio amplifier owner's manual. • Verify the volume is at an appropriate level and the mute feature is not on. • Make sure MTS feature is properly set.
No TV signal	<ul style="list-style-type: none"> • Verify the TV is set to Antenna mode. • Make sure the antenna is securely connected to the RF in jack. • Unplug the TV from the wall for 30 seconds, then plug in and try again. • Unplug the antenna connection from the back of the TV, unplug the TV from the wall, wait 30 seconds, then try again.
Stripe or purple interference appears in the screen.	<ul style="list-style-type: none"> • Verify the speakers around the TV set are shielded.
Picture becomes snowy.	<ul style="list-style-type: none"> • Verify the antenna lead wire is in working condition. • Verify the antenna is connected securely to the RF in jack.
Picture with multi-image	<ul style="list-style-type: none"> • Move the antenna around to minimize multi-images. • The video frequency radiated from TV station can be reflected by tall buildings, high tower, etc.
TV channel not received	<ul style="list-style-type: none"> • Make sure the Air/Cable setting is correct. • Channel may be locked with the block channel feature, such as Parental Control. • Check Add/Erase feature, as channel may have been erased during set up.
Black box appears on screen.	<ul style="list-style-type: none"> • Verify Closed Caption feature is off.
Remote control doesn't operate.	<ul style="list-style-type: none"> • Batteries may be weak. Replace batteries. • Make sure nothing is located between the remote and the remote sensor.
No stereo or foreign language received.	<ul style="list-style-type: none"> • Verify MTS feature is properly set.

LIMITED UNITED STATES WARRANTY (PF2020/PF2030/PF2720/PF2730/PF3220/PF3230)

Apex Digital, Inc. makes the following limited warranties. These limited warranties extend to the original consumer purchaser or any person receiving this product as a gift from the original consumer purchaser and to no other purchaser or transferee.

Limited Ninety (90) Days Warranty

Apex Digital, Inc. warrants this product and its parts against defects in material or workmanship for a period of ninety (90) days after the date of original retail purchase. During this period Apex Digital, Inc. will repair or replace a defective part or product at their option, with a new or refurbished part or product, without charge to you. Depending on the service required it will either be performed in your home or at the Service Center's repair facility. When repaired, it will be returned to your home at no cost to you. For 20" television, you must deliver the entire product to an Authorized Apex Digital, Inc. Service Center. You are responsible for all transportation charges for the set to and from the Service Center. For 27" and 32" televisions, an authorized Apex Digital, Inc. Service Center personnel will come to your home when warranty service is required.

Limited One (1) Year Warranty

Apex Digital, Inc. further warrants the parts in this product against defects in material or workmanship for a period of one (1) year after the date of original retail purchase with exception of the remote control which is guaranteed for ninety (90) days. During this period Apex Digital, Inc. will replace a defective part with a new or refurbished part without charge to you, except that if a defective part is replaced after ninety (90) days from the date of original retail purchase, you are responsible to pay all labor charges involved in the part(s) replacement including all packing, transportation and insurance charges for the set to and from the Service Center. For 20" television, you must also deliver the entire product to an Apex Digital, Inc. Authorized Service Center.

Limited Two (2) Years Warranty

Apex Digital, Inc. further warrants the picture tube in this product against defects in materials or workmanship for a period of two (2) years after the date of original retail purchase. During this period Apex Digital, Inc. will replace the defective picture tube at their option with a new or rebuilt picture tube or at their option replace the entire product with a new or refurbished product at no charge to you; if however the defective picture tube or product is replaced after one (1) year from the date of the original retail purchase, you pay all labor, packing and transportation charges involved in the replacement.

Rental Product

The warranty for a rental product begins with the original date of receipt by the rental firm.

Your Responsibility

The above warranties are subject to the following conditions:

- **You must retain your bill of sale to provide proof of purchase.**
- **For 20" television, you must retain all packing materials for return shipment.**
- All warranty service of this product must be made by an Authorized Apex Digital, Inc. Service Center.
- These warranties are effective only if the product is purchased and operated in the U.S.A.
- Labor service charges for set installation, setup, adjustment of customer controls and installation or repair of any type of antenna or cable systems are not covered by this warranty. Reception problems caused by inadequate antenna or cable system are your responsibility.
- **Warranties extend only to defects in materials or workmanship as limited above and do not extend to any product or parts which have been lost or discarded by you or damage to product or parts caused by misuse, accident, damage caused by Acts of God, such as lightning or fluctuations in electrical power, improper installation, improper maintenance or use in violation of instructions furnished by us; or to product which has been modified or had the serial number removed, altered, defaced or rendered illegible. Warranties do not cover cosmetic damages or lost accessories.**

How to Obtain Warranty Service

If after following all the operating instructions in this manual and reading the TROUBLESHOOTING section you find that service is necessary:

1. Contact our Customer Service Center directly call 866-4-APEX-INC-(866-427-3946), Mon - Fri 8:30am - 5:00pm (California).
2. After obtaining the requested information, you must present your receipt to the Authorized Service Center to obtain warranty service.
3. For 20" television, you must deliver the entire product to the Authorized Service Center. You are responsible for all transportation for the product to and from the Service Center. For 27" and 32" televisions, an authorized Apex Digital, Inc. Service Center personnel will come to your home when warranty service is required. Depending on the service required, it will either be performed in your home or the set will be taken to the authorized Apex Digital, Inc. Service Center's repair facility for repair and then returned to your home at no cost to you, while under the Limited Ninety (90) Days Warranty.

Limitations

All warranties implied by state law, including the implied warranties of merchantability and fitness for a particular purpose, are expressly limited to the duration of the limited warranties as set forth above. With the exception of any warranties implied by state law as hereby limited, the foregoing warranty is exclusive and in lieu of all other warranties, guarantees, agreements and similar obligations of manufacturers or seller with respect to the repair or replacement of any parts. In no event shall Apex Digital, Inc. be liable for consequential or incidental damages.

No person, agent, distributor, dealer or company is authorized to change, modify or extend the terms of these warranties in any manner whatsoever. The time within which action must be commenced to enforce any obligation of Apex Digital, Inc. arising under this warranty or under any statute, or law of the United States or any state thereof, is hereby limited to ninety (90) days from the date you discover or should have discovered the defect. This limitation does not apply to implied warranties arising under state law.

This warranty gives you specific rights and you may also have these rights which may vary from state to state. Some states do not allow limitation on how long an implied warranty lasts, when an action may be brought, or the exclusion or limitation of incidental or consequential damages, so the above provisions may not apply to you.

APEX Digital, Inc.
Ontario, CA 91761
FOR SERVICE CALL: 866-4-APEX-INC

<http://www.apexdigitalinc.com>