

SAMSUNG

**TX-S3064WR
TX-S3065WR**

COLOR TELEVISION



**Owner's
Instructions**

Register your product at www.samsung.com/global/register

Important Warranty Information Regarding Television Format Viewing

Standard screen format televisions (4:3, the aspect ratio of the screen width to height) are primarily designed to view standard format full-motion video. The images displayed on them should primarily be in the standard 4:3 ratio format and constantly moving. Displaying stationary graphics and images on screen, such as the dark top and bottom letterbox bars (wide screen pictures), should be limited to no more than 15% of the total television viewing per week.

Wide screen format televisions (16:9, the aspect ratio of the screen width to height) are primarily designed to view wide screen format full-motion video. The images displayed on them should primarily be in the wide screen 16:9 ratio format, or expanded to fill the screen if your model offers this feature, and constantly moving. Displaying stationary graphics and images on screen, such as the dark side-bars on non-expanded standard format television video and programming, should be limited to no more than 15% of the total television viewing per week.

Additionally, viewing other stationary images and text such as stock market reports, video game displays, station logos, web sites or computer graphics and patterns, should be limited as described above for all televisions. ***Displaying any stationary images that exceed the above guidelines can cause uneven aging of picture tubes (CRTs) that leave subtle, but permanent burned-in ghost images in the television picture. To avoid this, vary the programming and images, and primarily display full screen moving images, not stationary patterns or dark bars.*** On television models that offer picture sizing features, use these controls to view the different formats as a full screen picture.

Be careful in the selection and duration of television formats used for viewing. Uneven CRT aging as a result of format selection and use, as well as other burned-in images, is not covered by your Samsung limited warranty.

Contents

GENERAL INFORMATION

- List of Features 4
- Accessories 4
- Viewing the Control Panel 5
- Viewing the Connection Panel 6
- Remote Control 7
- Installing Batteries in the Remote Control 8

CONNECTIONS

- Connecting VHF and UHF Antennas 8
- Connecting Cable TV 9
- Connecting a VCR 10
- Connecting an S-VHS VCR 10
- Connecting a Second VCR to Record from the TV 11
- Connecting a Camcorder 11
- Connecting a DVD Player/Set-Top Box 12
- Connecting a DVD Player/Set-Top Box via HDMI 12
- Connecting an Amplifier/DVD Home Theater 13

OPERATION

- Turning the TV On and Off 13
- Plug & Play Feature 13
- Changing Channels 14
- Adjusting the Volume 15
- Viewing the Display 15
- Viewing the Menus 15
- Memorizing the Channels 16
- To Select the Source 17
- To Edit the Input Source Name 17

PICTURE CONTROL

- Using Automatic Picture Settings 18
- Changing the Screen Size 19
- Freezing the Current Picture 19
- Digital Noise Reduction 20
- Tilt 20
- Setting the Film Mode 20

SOUND CONTROL

- Using Automatic Sound Settings 21
- Customizing the Sound 21
- Setting the SRS TruSurround XT 22
- Choosing a Multi-Channel Sound (MTS) track 22
- Automatic Volume Control 23

CHANNEL CONTROL

- Adding and Erasing Channels 23
- Labeling Channels 24
- Fine Tuning Channel Reception 24

TIME SETTING

- Setting the Time 25

FUNCTION DESCRIPTION

- Using the V-Chip 27
- Viewing Closed Captions(On-Screen Text Messages) 33
- Selecting a Menu Language 34
- Setting the Blue Screen Mode 34
- Setting the On/Off Melody 34

APPENDIX

- Identifying Problems 35
- Specifications 35



General Information

List of Features

- ♦ Adjustable picture settings that can be stored in the TV's memory.
- ♦ Automatic timer to turn the TV on and off.
- ♦ A special sleep timer.
- ♦ V-Chip function.
- ♦ SRS TruSurround XT
 - SRS TruSurround XT provides a virtual Dolby surround system.

Accessories

Please make sure the following items are included with your TV.
If any items are missing, contact your dealer.



Remote Control
AAA Batteries



Owner's Instructions /
Safety Guide Manual



Warranty Cards / Registration Card
(Not available in all locations)

The following parts are sold separately and are available at most electronics stores.



S-VIDEO Cable



Antenna Cable

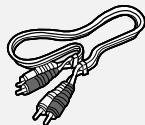

Audio Cable

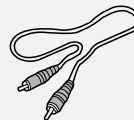

Video Cable

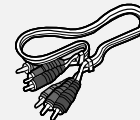

Component Cable

Viewing the Control Panel

Buttons on the Lower-Right Part of the Panel

The buttons on the lower-right panel control your TV's basic features, including the on-screen menu.

To use the more advanced features, you must use the remote control. The product color and shape may vary depending on the model.

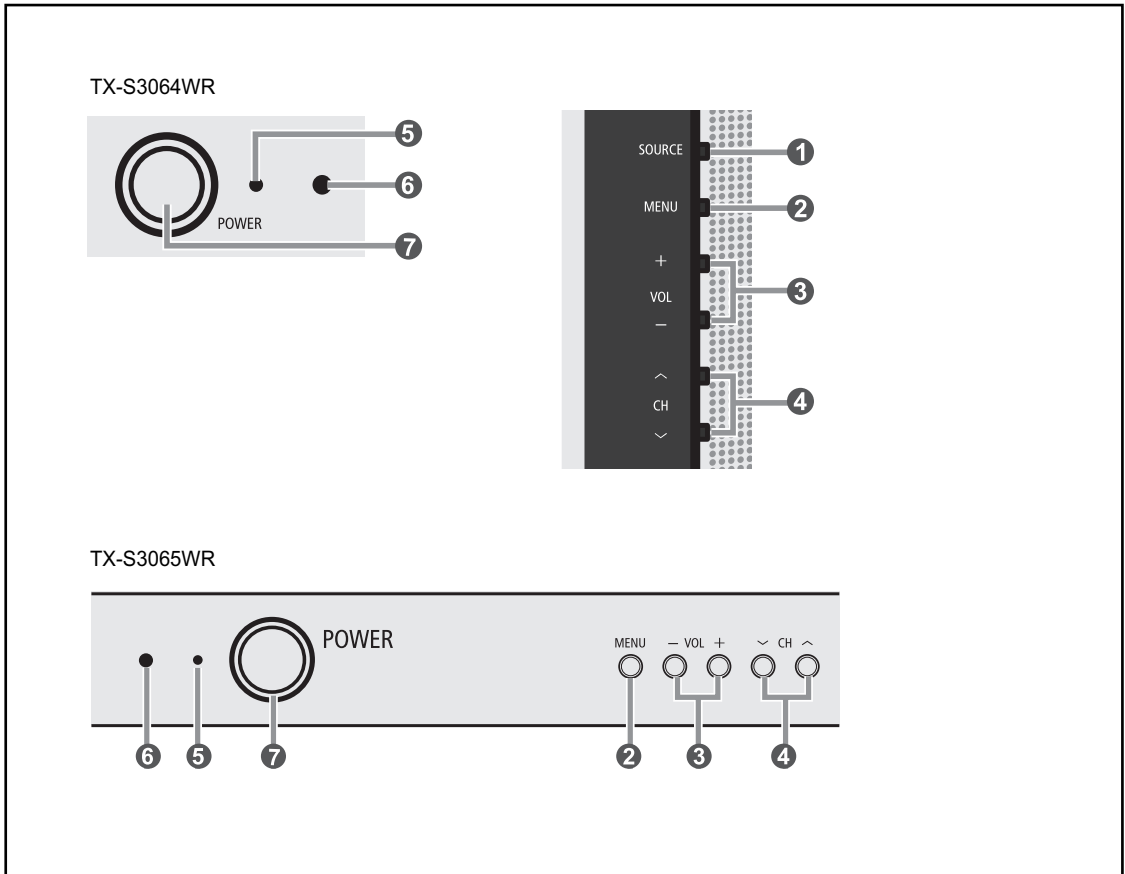

1 SOURCE

Toggles between all the available input sources (TV, AV1, AV2, AV3/S-Video, Component1, Component2, HDMI).

In the on-screen menu, use this button as you would use the **ENTER** button on the remote control.

2 MENU

Press to see an on-screen menu of your TV's features.

3 + VOL -

Press to increase or decrease the volume.

In the on-screen menu, use the **+ VOL -** buttons as you use the ◀ and ▶ buttons or **ENTER** (⏏) button on the remote control.

4 ^ CH v

Press to change channels.

In the on-screen menu, use the ^ **CH** v button as you would use the ▲ and ▼ button on the remote control.

5 Power Indicator

Blinks and turns off when the power is on and lights up in stand-by mode.

6 REMOTE CONTROL SENSOR

Aim the remote control towards this spot on the TV.

7 POWER

Press to turn the TV on and off.

Viewing the Connection Panel

Rear Panel Jacks

Use the rear panel jacks to connect A/V components that will be connected continuously, such as VCR or DVD players. For more information on connecting equipment, see pages 8-13.

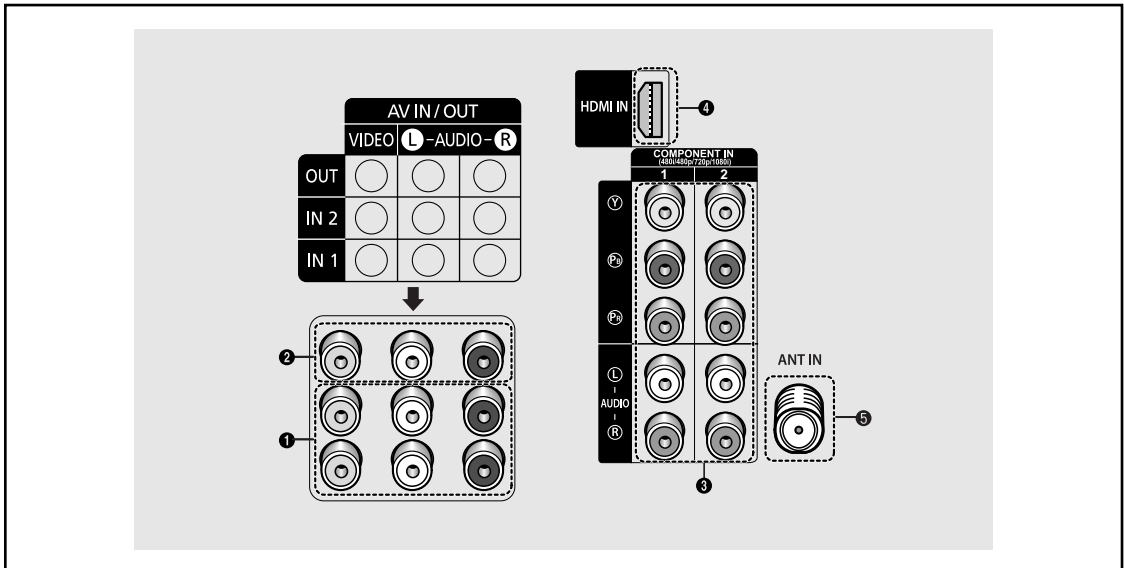

1 AV IN 1, 2

Connect to the video output jacks of VCRs, DVD players and similar devices.

2 AV OUT

Connect to the audio/video input jacks of a recording VCR.

3 COMPONENT IN 1, 2 (480i/480p/720p/1080i)

Connect Component audio and video.

4 HDMI IN

Connect to the HDMI jack of a device with an HDMI output.

5 ANT IN

Connect to an antenna(air) or cable TV system.

Side Panel Jacks

Use the left side panel jacks to connect a component that is used only occasionally, such as a camcorder or video game. (See page 11) The product color and shape may vary depending on the model.

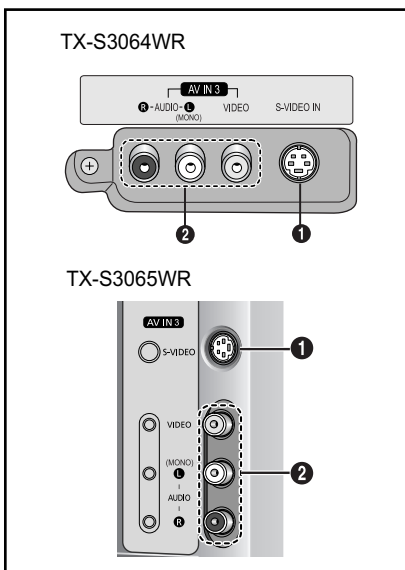

1 S-VIDEO

Video inputs for external devices with an S-Video output.

2 AV IN 3

Video and audio inputs for external devices, such as a camcorder or VCR.

Remote Control

You can use the remote control up to a distance of about 23 feet from the TV. When using the remote control, always point it directly at the TV. You can also use your remote control to operate your VCR, Cable box, DVD player, or Set-Top Box.

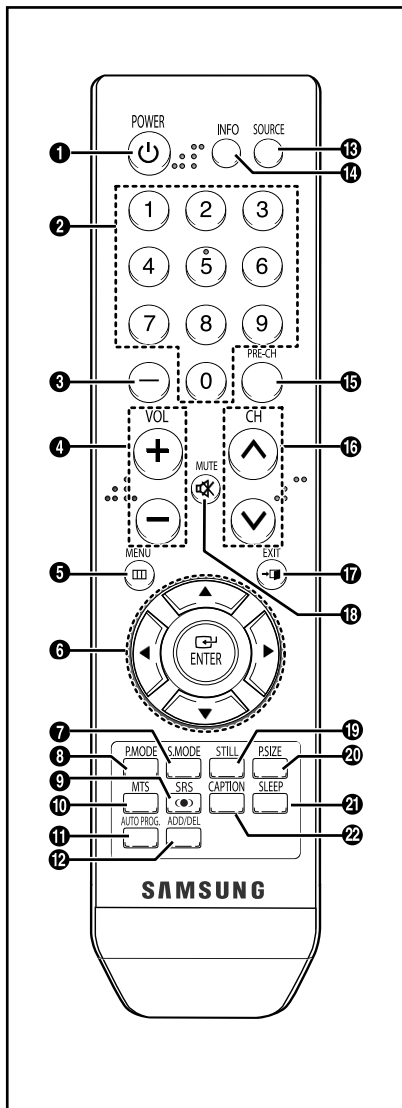

- 1 POWER**
Turns the TV on and off.
- 2 NUMERIC BUTTONS**
Press to change the channel.
- 3 -**
Use to select a channel over 100. For example, for channel 122, press "-", then "2", then "2".
- 4 + VOL -**
Press to increase or decrease the volume.
- 5 MENU**
Displays the main on-screen menu.
- 6 UP▲ / DOWN▼ / LEFT◀ / RIGHT▶ / ENTER** 
Use to select on-screen menu items and change menu values.
- 7 S.MODE**
Press to select the sound mode.
- 8 P.MODE**
Press to select the picture mode.
- 9 SRS**
Selects SRS TruSurround XT mode.
- 10 MTS**
Press to choose stereo, mono or Separate Audio Program (SAP broadcast).
- 11 AUTO PROG.**
Press to automatically store selected Air/Cable channels.
- 12 ADD/DEL**
Use to store and delete channels to/from memory.
- 13 SOURCE**
Press to display all of the available video sources.
- 14 INFO**
Press to display information on the TV screen.
- 15 PRE-CH**
Tunes to the previous channel.
- 16 ^ CH v**
Press to change channels.
- 17 EXIT**
Press to exit the menu.
- 18 MUTE**
Press to temporarily cut off the sound.
- 19 STILL**
Press to picture still.
- 20 P.SIZE**
Press to change the screen size.
- 21 SLEEP**
Press to select a preset time interval for automatic shut off.
- 22 CAPTION**
Controls the caption decoder.

➤ This is a special remote control for the visually impaired, and has Braille points on the Power, Channel and Volume buttons.

Installing Batteries in the Remote Control

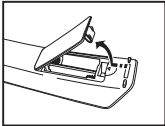

1. Lift the cover at the back of the remote control upward as shown in the figure.
2. Install two AAA size batteries.
 - Make sure to match the "+" and "-" ends of the batteries with the diagram inside the compartment.
3. Replace the cover.
 - Remove the batteries and store them in a cool, dry place if you won't be using the remote control for a long time. The remote control can be used up to about 23 feet from the TV. (Assuming typical TV usage, the batteries last for about one year.)

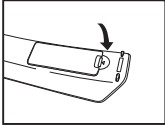
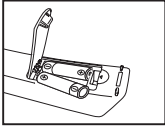

- **If the remote control doesn't work, check the following:**
1. Is the TV power on?
 2. Are the plus and minus ends of the batteries reversed?
 3. Are the batteries drained?
 4. Is there a power outage, or is the power cord unplugged?
 5. Is there a special fluorescent light or neon sign nearby?

Connections

Connecting VHF and UHF Antennas

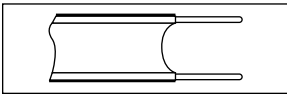

If your antenna has a set of leads that look like this, see "Antennas with 300 Ω Flat Twin Leads" below.

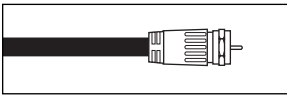

If your antenna has one lead that looks like this, see "Antennas with 75 Ω Round Leads". If you have two antennas, see "Separate VHF and UHF Antennas".

Antennas with 300 Ω Flat Twin Leads

If you are using an off-air antenna (such as a roof antenna or "rabbit ears") that has 300 Ω twin flat leads, follow the directions below.

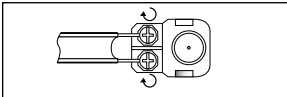

1. Place the wires from the twin leads under the screws on a 300-75 Ω adapter (not supplied). Use a screwdriver to tighten the screws.

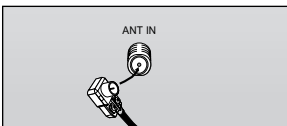

2. Plug the adaptor into the ANT IN terminal on the back of the TV.

Antennas with 75 Ω Round Leads

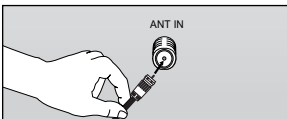

1. Plug the antenna lead into the ANT IN terminal on the back of the TV.

Separate VHF and UHF Antennas

If you have two separate antennas for your TV (one VHF and one UHF), you must combine the two antenna signals before connecting the antennas to the TV. This procedure requires an optional combiner-adaptor (available at most electronics shops).

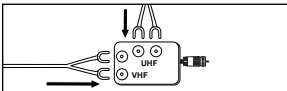

1. Connect both antenna leads to the combiner.

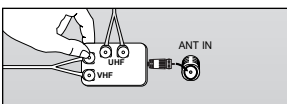

2. Plug the combiner into the ANT IN terminal on the bottom of the back panel.

Connecting Cable TV

To connect to a cable TV system, follow the instructions below.

Cable without a Cable Box

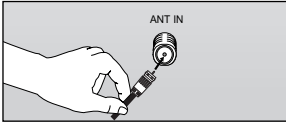

1. Plug the incoming cable into the ANT IN terminal on the back of the TV.
 - Because this TV is cable-ready, you do not need a cable box to view unscrambled cable channels.

Connecting to a Cable Box that Descrambles All Channels

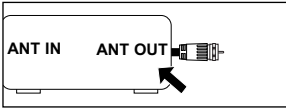

1. Find the cable that is connected to the ANT OUT terminal on your cable box.
 - This terminal might be labeled "ANT OUT", "VHF OUT" or simply, "OUT".

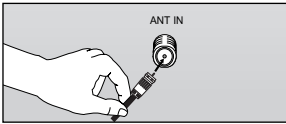

2. Connect the other end of this cable to the ANT IN terminal on the back of the TV.

Connecting to a Cable Box that Descrambles Some Channels

If your cable box descrambles only some channels (such as premium channels), follow the instructions below. You will need a two-way splitter, an RF (A/B) switch, and four lengths of Antenna Cable. (These items are available at most electronics stores.)

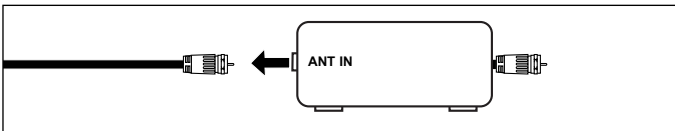

1. Find and disconnect the cable that is connected to the ANT IN terminal on your cable box.
 - This terminal might be labeled "ANT IN", "VHF IN" or simply, "IN".

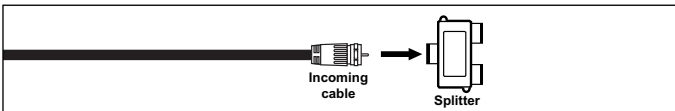

2. Connect this cable to a two-way splitter.

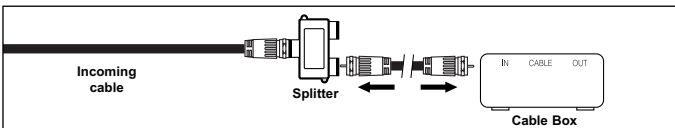

3. Connect an Antenna Cable between an OUTPUT terminal on the splitter and the IN terminal on the cable box.

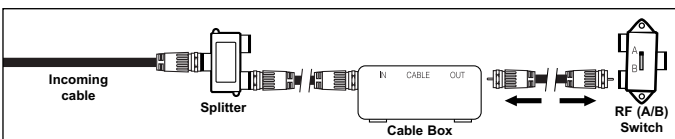

4. Connect an Antenna Cable between the ANT OUT terminal on the cable box and the B-IN terminal on the RF (A/B) switch.

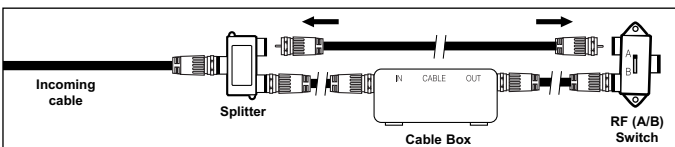

5. Connect another cable between the other OUTPUT terminal on the splitter and the A-IN terminal on the RF (A/B) switch.

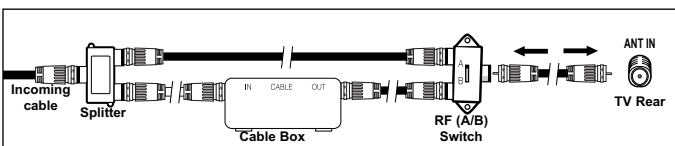

6. Connect the last Antenna Cable between the OUT terminal on the RF (A/B) switch and the ANT IN terminal on the rear of the TV.

After you have made this connection, set the A/B switch to the "A" position for normal viewing. Set the A/B switch to the "B" position to view scrambled channels. (When you set the A/B switch to "B", you will need to tune your TV to the cable box's output channel, which is usually channel 3 or 4.)

Connecting a VCR

These instructions assume that you have already connected your TV to an antenna or a cable TV system (according to the instructions on pages 8-9). Skip step 1 if you have not yet connected to an antenna or a cable system.

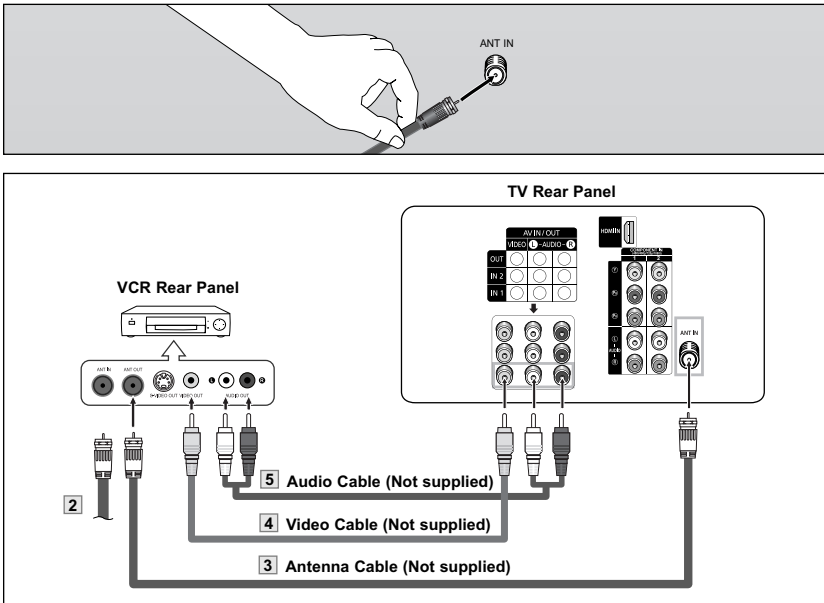

1. Unplug the cable or antenna from the back of the TV.
2. Connect the cable or antenna to the ANT IN terminal on the back of the VCR.
3. Connect an Antenna Cable between the ANT OUT terminal on the VCR and the ANT IN terminal on the TV.
4. Connect a Video Cable between the VIDEO OUT jack on the VCR and the AV IN 1 or AV IN 2 [VIDEO] jack on the TV.
5. Connect Audio Cables between the AUDIO OUT jacks on the VCR and the AV IN 1 or AV IN 2 [L-AUDIO-R] jacks on the TV.

- Each external input source device has a different back panel configuration.
- When connecting an external device, match the color of the connection terminal to the cable.
- Also, you can connect to "AV IN 3" on the side panel of TV.

- If you have a "mono" (non-stereo) VCR, use a Y-connector (not supplied) to hook up to the right and left audio input jacks of the TV. If your VCR is stereo, you must connect two cables.

Connecting an S-VHS VCR

Your Samsung TV can be connected to an S-Video signal from an S-VHS VCR. (This connection delivers a better picture as compared to a standard VHS VCR.)

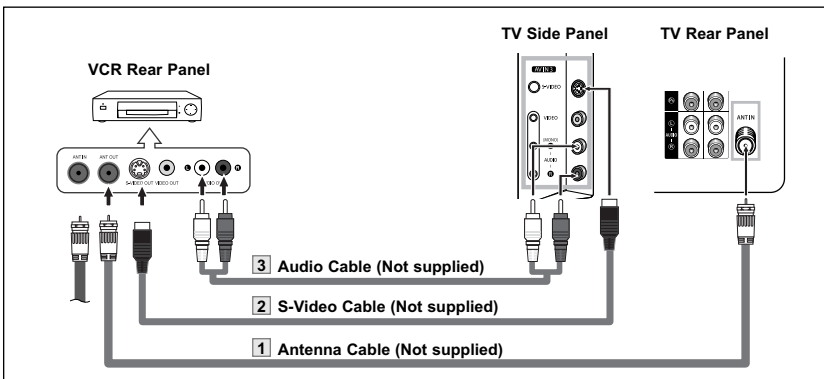

1. To begin, follow steps 1-3 in the previous section to connect the antenna or cable to your VCR and your TV.
2. Connect an S-Video Cable between the S-VIDEO OUT jack on the VCR and the AV IN 3 [S-VIDEO] jack on the TV.
3. Connect Audio Cables between the AUDIO OUT jacks on the VCR and the AV IN 3 [L-AUDIO-R] jacks on the TV.

An S-Video cable is usually included with an S-VHS VCR. (If not, check your local electronics store.)

- Each external input source device has a different back panel configuration.
- When connecting an external device, match the color of the connection terminal to the cable.

Connecting a Second VCR to Record from the TV

Your TV can send out signals of its picture and sound to be recorded by a second VCR. To do this, connect your second VCR as follows:

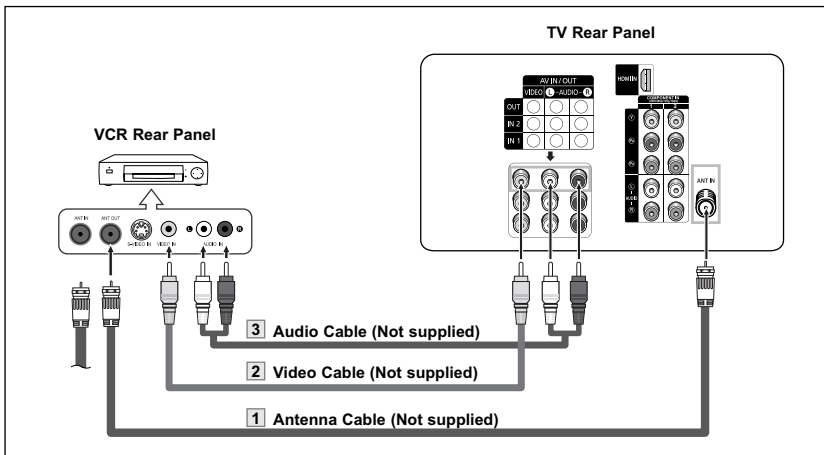

➤ When connecting an external device, match the color of the connection terminal to the cable.

1. To begin, follow steps 1–3 in the previous section to connect the antenna or cable to your VCR and your TV.
2. Connect a video cable between the AV OUT [VIDEO] jack on the TV and the VIDEO IN jack on the VCR. Refer to your VCR's instructions for more information about how to record using this kind of connection.
3. Connect a set of audio cables between the AV OUT [L-AUDIO-R] jacks on the TV and the AUDIO IN jacks on the VCR. (The VCR input jacks might be either on the front or on back of the VCR.)

Connecting a Camcorder

The side panel jacks on your TV make it easy to connect a camcorder to your TV. They allow you to view the camcorder tapes without using a VCR.

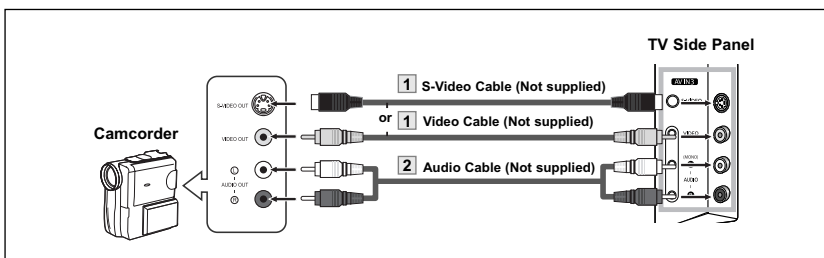

- Each external input source device has a different back panel configuration.
- When connecting an external device, match the color of the connection terminal to the cable.

1. Connect a Video Cable (or S-Video Cable) between the AV IN 3 [VIDEO] (or S-VIDEO) jack on the TV and the VIDEO (or S-VIDEO) jack on the camcorder.
2. Connect Audio Cables between the AV IN 3 [L-AUDIO-R] jacks on the TV and the AUDIO OUT jacks on the camcorder.

Connecting a DVD Player/Set-Top Box

The rear panel jacks on your TV make it easy to connect a DVD player/Set-Top Box to your TV.

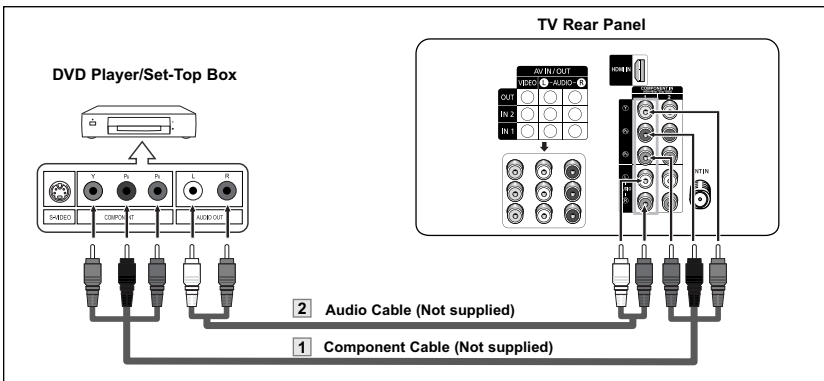

- Component video separates the video into Y (Luminance (Brightness)), Pb (Blue) and Pr (Red) for enhanced video quality. Be sure to match the component video and audio connections. For example, if connecting the video cable to COMPONENT IN, connect the audio cable to COMPONENT IN also.
- Each external input source device has a different back panel configuration.
- When connecting an external device, match the color of the connection terminal to the cable.

1. Connect a Component Cable between the COMPONENT IN 1 [Y, Pb, Pr](or COMPONENT IN 2 [Y, Pb, Pr]) jacks on the TV and the COMPONENT Y, Pb, Pr jacks on the DVD Player/Set-Top Box.
2. Connect Audio Cables between the COMPONENT IN 1 [L-AUDIO-R](or COMPONENT IN 2 [L-AUDIO-R]) jacks on the TV and the AUDIO OUT jacks on the DVD Player/Set-Top Box.

Connecting a DVD Player/Set-Top Box via HDMI

This connection can only be made if there is an HDMI/DVI Output jack on the external device.

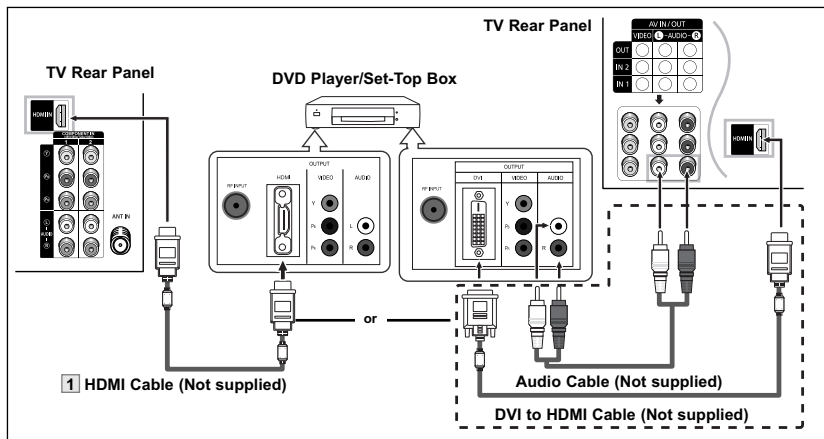

1. Connect an HDMI Cable between the [HDMI IN] on the TV and the HDMI OUT on the DVD player/Set-Top Box or connect a DVI to HDMI Cable or DVI-HDMI Adapter between the [HDMI IN] jack on the TV and the DVI jack on the DVD player/Set-Top Box.

If connecting via HDMI/DVI, you must also connect audio cables. Connect Audio Cables between the AV IN 1 [L-AUDIO-R] jacks on the TV and the AUDIO OUT jacks on the DVD player/Set-Top Box.

What is HDMI?

- HDMI, or high-definition multimedia interface, is a next-generation interface that enables the transmission of digital audio and video signals using a single cable without compression.
- "Multimedia interface" is a more accurate name for it especially because it allows multiple channels of digital audio (5.1 channels).
The difference between HDMI and DVI is that the HDMI device is smaller in size, has the HDCP (High Bandwidth Digital Copy Protection) coding feature installed, and supports multi-channel digital audio.
- Each external input source device has a different back panel configuration.
- When connecting an external device, match the color of the connection terminal to the cable.
- When connecting via HDMI, you do not need to connect Audio Cables. You only need to connect Audio cables when connecting via HDMI/DVI.

Connecting an Amplifier/DVD Home Theater

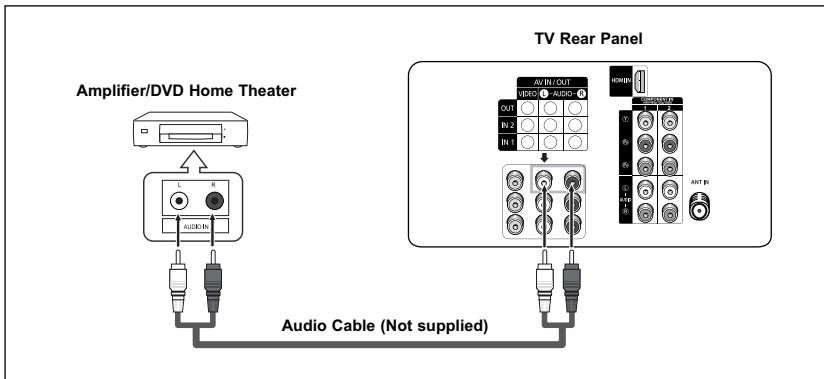

- Each external input source device has a different back panel configuration.
- When connecting an external device, match the color of the connection terminal to the cable.

1. Connect Audio Cables between the AV OUT [L-AUDIO-R] on the TV and AUDIO IN on the Amplifier/DVD Home Theater.

When an audio amplifier is connected to the "AUDIO OUT [L-AUDIO-R]" terminals: Decrease the gain (volume) of the TV, and adjust the volume level with the Amplifier's volume control.

Operation

Turning the TV On and Off

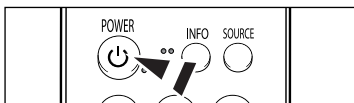

Press the **POWER** button on the remote control.
You can also use the **POWER** button on the TV.

Plug & Play Feature

When the television is initially powered on, three basic customer settings proceed automatically and subsequently: setting the language, channel and clock.

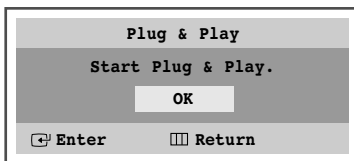

1. Press the **POWER** button on the remote control.
The message "Plug & Play" is displayed. It flickers for a little while and then Language menu is automatically displayed.



2. Press the **▲** or **▼** button to select the language, then press the **ENTER** button.
The message "Check antenna input." is displayed.
➤ If any language is not selected on the Language menu, the Language menu will disappear about 30 seconds later.

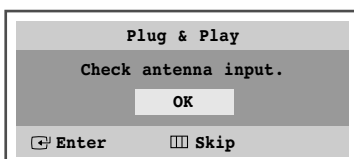

3. Make sure that the antenna is connected to the TV.
Press the **ENTER** button.
The "Search" menu is displayed.

Continued...

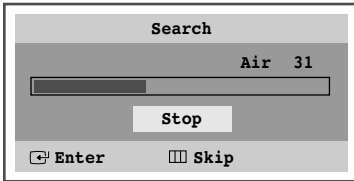

- Press the **ENTER** button to select "Start".
The TV will begin memorizing all of the available channels.
Press the **ENTER** button to stop. After all the available channels are stored, the "Clock Set" menu appears.
➤ Refer to "Memorizing the Channels" on page 16.

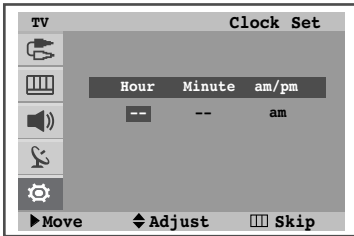

- Press the ◀ or ▶ button to move to the Hour, Minute or am/pm.
Set these by pressing the ▲ or ▼ button.
➤ Refer to "Setting the Time" on page 25.
➤ You can set the hour and minute directly by pressing the numeric buttons on the remote control.



- When you have finished, press the **MENU** button.
The message "Enjoy your watching." is displayed, then the channel which has been stored will be activated.

If you want to reset this feature...

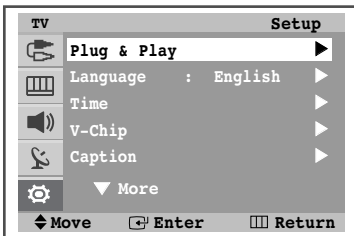

- Press the **MENU** button to display the menu.
Press the ▲ or ▼ button to select "Setup", then press the **ENTER** button.
The "Plug & Play" is selected.

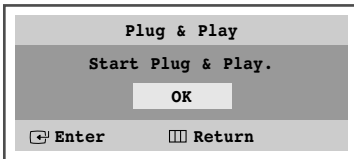

- Press the **ENTER** button again.
This feature starts with the message "Start Plug & Play." displayed.
For further details on setting up options, refer to the previous page.
➤ Plug & Play can only be accessed in the TV mode.

Changing Channels

Using the Channel Buttons

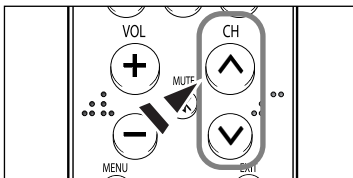

- Press the **CH ^** or **CH v** button to change channels.
➤ When you press the **CH ^** or **CH v** button, the TV changes channels in sequence.
You will see all the channels that the TV has memorized. (The TV must have memorized at least three channels). You will not see channels that were either erased or not memorized. See page 16 to memorize channels.

Using the Number Buttons

Use the number buttons to quickly tune to any channel.

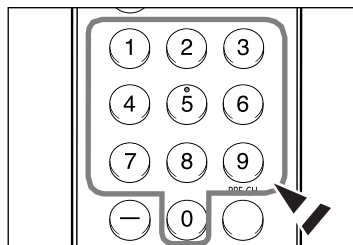

- Press the number buttons to go directly to a channel.
For example, to select channel 27, press "2," then "7."
The TV will change channels when you press the second number.

Continued...

Using the “-” Button

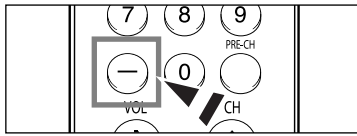

1. To select a channel over 100, for channel 122, press “-”, then “2”, then “2”.

Using the PRE-CH Button to select the Previous Channel

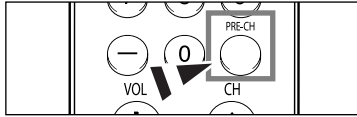

1. Press the **PRE-CH** button.
The TV will switch to the last channel viewed.
 - To quickly switch between two channels that are far apart, tune to one channel, then use the number button to select the second channel. Then use the **PRE-CH** button to quickly alternate between them.

Adjusting the Volume

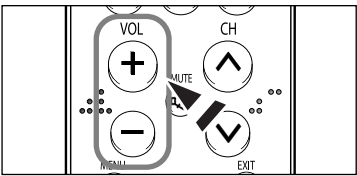

1. Press the **VOL +** or **VOL -** button to increase or decrease the volume.

Using Mute Button

At any time, you can cut off the sound using the **MUTE** button.

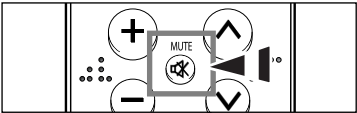

1. Press **MUTE** and the sound cuts off.
2. To turn mute off, press the **MUTE** button again, or simply press the **VOL +** or **VOL -** button.

Viewing the Display

The display identifies the current channel and the status of certain audio-video settings.

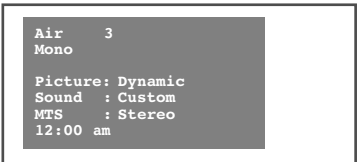

1. Press the **INFO** button on the remote control.
The TV will display the channel, the type of sound, and the status of certain picture and sound settings.

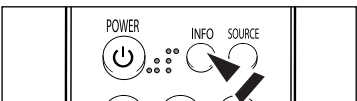

- ☞ Press the **INFO** button once more or wait approximately 10 seconds and it disappears automatically.

Viewing the Menus

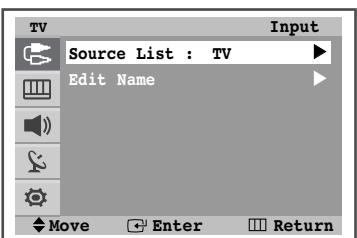

1. With the power on, press the **MENU** button.
The main menu appears on the screen. Its left side has five icons: Input, Picture, Sound, Channel, Setup.
2. Use the **▲** or **▼** button to select one of the five icons.
Then press the **ENTER** button to access the icon's sub-menu.
3. Press the **EXIT** button to exit.



- The on-screen menus disappear from the screen after two seconds.

Memorizing the Channels

Your TV can memorize and store all of the available channels for both “off-air” (antenna) and cable channels. After the available channels are memorized, use the **CH ^** or **CH v** button to scan through the channels. This eliminates the need to change channels by entering the channel digits. There are three steps for memorizing channels: selecting a broadcast source, memorizing the channels (automatic) and adding and deleting channels (manual).

Selecting the Video Signal-source

Before your television can begin memorizing the available channels, you must specify the type of signal source that is connected to the TV (i.e. an antenna or a cable system).

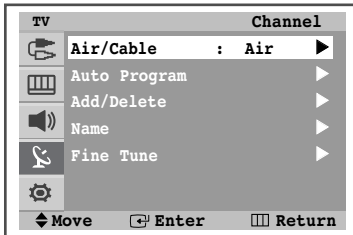

1. Press the **MENU** button to display the menu.
Press the **▲** or **▼** button to select “Channel”, then press the **ENTER** button.

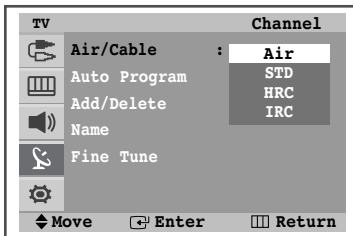

2. Press the **ENTER** button to select “Air/Cable”.
Press the **▲** or **▼** button to select “Air”, “STD”, “HRC”, or “IRC”, then press the **ENTER** button.
Press the **EXIT** button to exit.

Storing Channels in Memory (Automatic Method)

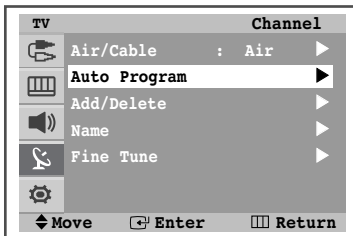

1. Press the **MENU** button to display the menu.
Press the **▲** or **▼** button to select “Channel”, then press the **ENTER** button.
2. Press the **▲** or **▼** button to select “Auto Program”, then press the **ENTER** button.

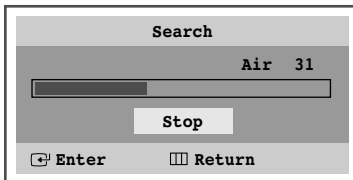

3. Press the **ENTER** button to start the auto program.
The TV begins memorizing all available channels.
Press the **ENTER** button at any time to interrupt the memorization process.
Press the **EXIT** button to exit.

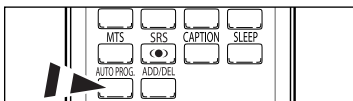

-  You can also press the **AUTO PROG.** button on the remote control to bring up the Auto Program menu.

To Select the Source

Use to select TV or other external input sources connected to the TV.
Use to select the input source of your choice.

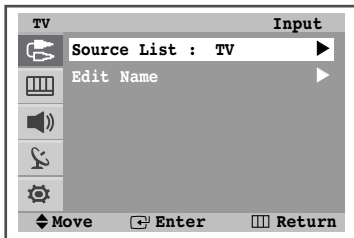

1. Press the **MENU** button to display the menu.
Press the **ENTER** button to select "Input".

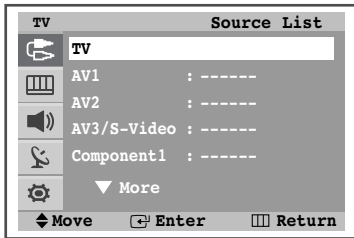

2. Press the **ENTER** button to select "Source List".
Press the **▲** or **▼** button to select signal source, then press the **ENTER** button.
 - When you connect equipment to the TV, you can choose between the following sets of jacks: AV1, AV2, AV3/S-Video, Component1, Component2, or HDMI on the TV's rear panel and AV3 or S-Video on the TV's side panel.

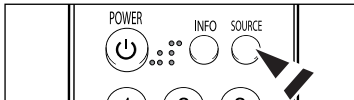

-  Press the **SOURCE** button on the remote control to view an external signal source.

To Edit the Input Source Name

Name the device connected to the input jacks to make your input source selection easier.

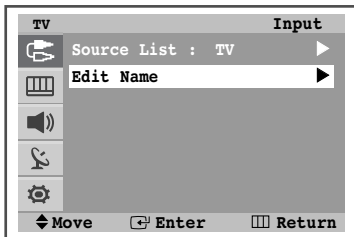

1. Press the **MENU** button to display the menu.
Press the **ENTER** button to select "Input".
Press the **▲** or **▼** button to select "Edit Name", then press the **ENTER** button.

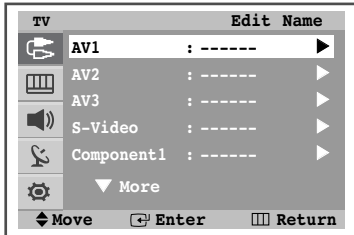

2. Press the **▲** or **▼** button to select "AV1", "AV2", "AV3", "S-Video", "Component1", "Component2", or "HDMI" input jack, then press the **ENTER** button.

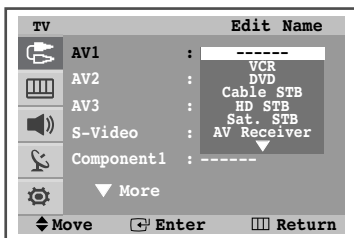

3. Press the **▲** or **▼** button to select "VCR", "DVD", "Cable STB", "HD STB", "Sat. STB", "AV Receiver", "DVD Receiver", "Game", "Camcorder", "DVD Combo", "DHR", or "PC" input source, then press the **ENTER** button.
Press the **EXIT** button to exit.

Picture Control

Using Automatic Picture Settings

Your TV has four automatic picture settings (“Dynamic”, “Standard”, “Movie”, “Custom”) that are preset at the factory. You can activate either Dynamic, Standard, Movie, or Custom by making a selection from the menu.

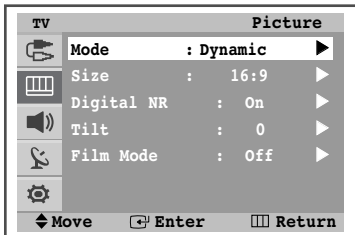

1. Press the **MENU** button to display the menu. Press the **▲** or **▼** button to select “Picture”, then press the **ENTER** button.

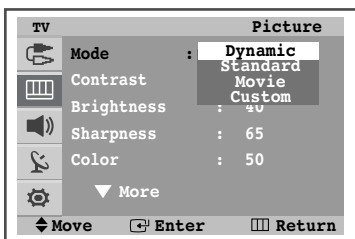

2. Press the **ENTER** button twice to select “Mode”. Press the **▲** or **▼** button to select the “Dynamic”, “Standard”, “Movie”, or “Custom” picture setting, then press the **ENTER** button.

- Choose **Dynamic** to increase the clarity and sharpness of the picture.
- Choose **Standard** for the standard factory settings.
- Choose **Movie** when watching movies.
- Choose **Custom** if you want to adjust the settings according to personal preference.

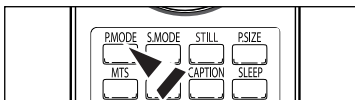

- a. Press the **P.MODE** button on the remote control to select one of the standard picture settings.

3. Press the **▲** or **▼** button to select “Contrast”, “Brightness”, “Sharpness”, “Color” or “Tint” then press the **ENTER** button.
 - After adjusting an item, the gauge will automatically disappear (after about 10 seconds).

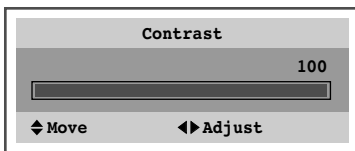

4. Press the **◀** or **▶** button to decrease or increase the value of a particular item.
 - Each adjusted setting will be stored separately according to its input mode.
 - When you make changes to Contrast, Brightness, Sharpness, Color, or Tint, OSD color will also be adjusted accordingly.

5. Press the **ENTER** button to return to “Mode”.

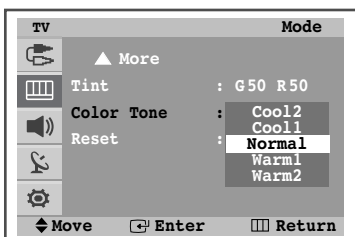

6. Press the **▲** or **▼** button to select “Color Tone”, then press the **ENTER** button.

7. Press the **▲** or **▼** button to select “Cool2”, “Cool1”, “Normal”, “Warm1”, or “Warm2”, then press the **ENTER** button.
 - Only TV, AV and S-Video can activate Tint in picture mode.

Resetting the Picture Settings to the Factory Defaults

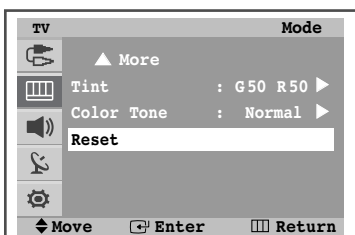

8. Press the **▲** or **▼** button to select “Reset”, then press the **ENTER** button.

- Press the **EXIT** button to exit.
- Each picture mode can be reset.

Changing the Screen Size

You can select the picture size which best corresponds to your viewing requirements.

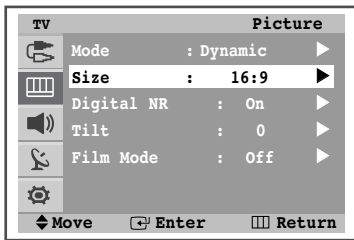

1. Press the **MENU** button to display the menu.
Press the **▲** or **▼** button to select "Picture", then press the **ENTER** button.
2. Press the **▲** or **▼** button to select "Size", then press the **ENTER** button.

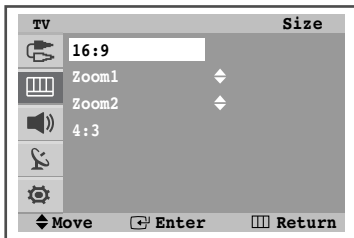

3. Press the **▲** or **▼** button to select the desired size, then press the **ENTER** button.

- ◆ **16:9**: Sets the picture to 16:9 wide mode.
- ◆ **Zoom1**: Magnifies the size of the picture on the screen.
- ◆ **Zoom2**: Expands the Zoom1 format picture.
- ◆ **4:3**: Sets the picture to 4:3 normal mode.

Press the **EXIT** button to exit.

* Available Picture Size for Component and HDMI Mode

Mode	Nomal Model				Wide Model			
	Normal	Zoom1	Zoom2	Wide	16:9	Zoom1	Zoom2	4:3
480i/576i	○	○	○	X	○	○	○	○
480p/576p	○	X	X	X	○	X	X	○
720p/1080i	○	X	X	○	○	X	X	X

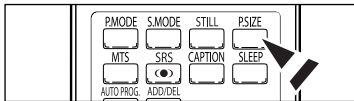

 Press the **P.SIZE** button on the remote control to change the picture size.

- Changing the Screen Format feature availability depends on the current broadcasting signal format.

Viewing with a 4:3 signal (When a 4:3 signal is received)





Viewing with a 16:9 signal (When a 16:9 signal is received)

The illustrations below show the picture change while viewing a DVD title.

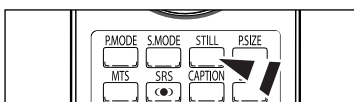

Freezing the Current Picture



 Press the **STILL** button on the remote control to freeze the picture when watching a television programme.

- To return to normal viewing, press this button again.

Digital Noise Reduction

If the broadcast signal received by your TV is weak, you can activate the Digital Noise Reduction feature to help reduce any static and ghosting that may appear on the screen.

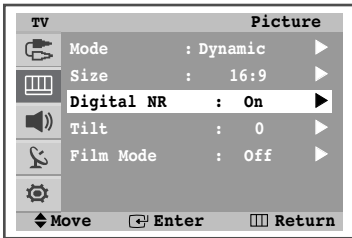

1. Press the **MENU** button to display the menu.
Press the **▲** or **▼** button to select "Picture", then press the **ENTER** button.
2. Press the **▲** or **▼** button to select "Digital NR", then press the **ENTER** button.

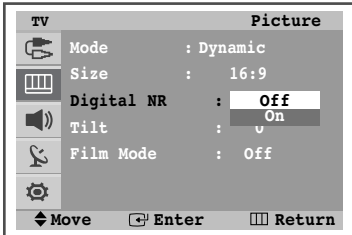

3. Press the **▲** or **▼** button to select "Off" or "On", then press the **ENTER** button.
Press the **EXIT** button to exit.

Tilt

Due to the Earth's magnetic field there may be some minor image tilt depending on the TV's location. When this occurs, follow the steps below.

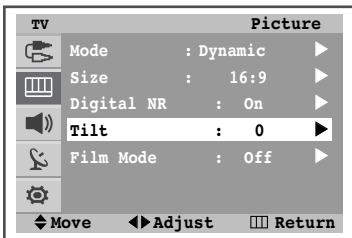

1. Press the **MENU** button to display the menu.
Press the **▲** or **▼** button to select "Picture", then press the **ENTER** button.
2. Press the **▲** or **▼** button to select "Tilt", then press the **ENTER** button.
Press the **◀** or **▶** button to adjust screen tilt.
Press the **EXIT** button to exit.

Setting the Film Mode

Film mode automatically senses and processes film signals from all sources and adjust the picture for optimum quality.

- Film mode is supported in 480i only.

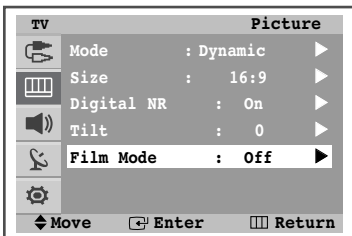

1. Press the **MENU** button to display the menu.
Press the **▲** or **▼** button to select "Picture", then press the **ENTER** button.
2. Press the **▲** or **▼** button to select "Film Mode", then press the **ENTER** button.

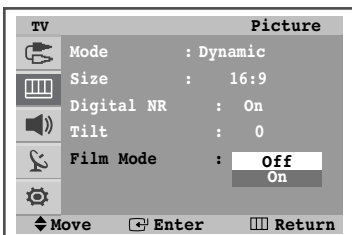

3. Press the **▲** or **▼** button to select "Off" or "On", then press the **ENTER** button.
Press the **EXIT** button to exit.

Sound Control

Using Automatic Sound Settings

Your TV has automatic sound settings (“Standard”, “Music”, “Movie”, “Speech”, and “Custom”) that are preset at the factory. Or, you can select “Custom”, which automatically recalls your personalized sound settings.

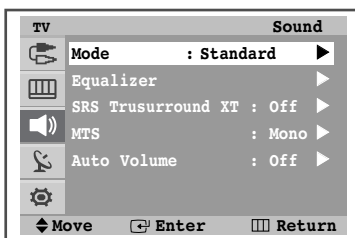

1. Press the **MENU** button to display the menu.
Press the **▲** or **▼** button to select “Sound”, then press the **ENTER** button.

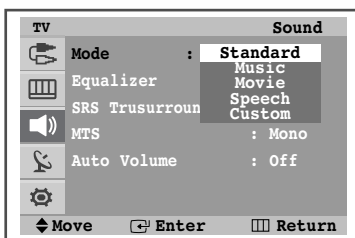

2. Press the **ENTER** button to select “Mode”.
Press the **▲** or **▼** button to select “Standard”, “Music”, “Movie”, “Speech”, or “Custom” sound setting, then press the **ENTER** button.

- Choose **Standard** for the standard factory settings.
- Choose **Music** when watching music videos or concerts.
- Choose **Movie** when watching movies.
- Choose **Speech** when watching a show that is mostly dialog (i.e., news).
- Choose **Custom** to recall your personalized settings (see “Customizing the Sound”).

Press the **EXIT** button to exit.

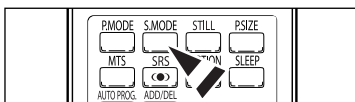

- Press the **S.MODE** button on the remote control to select one of the standard sound settings.

Customizing the Sound

The sound settings can be adjusted to suit your personal preference. (Alternatively, you can use one of the “automatic” settings.)

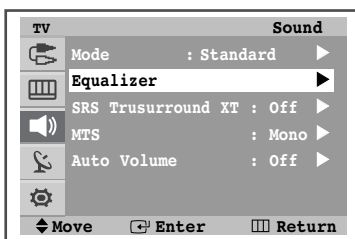

1. Press the **MENU** button to display the menu.
Press the **▲** or **▼** button to select “Sound”, then press the **ENTER** button.
2. Press the **▲** or **▼** button to select “Equalizer”, then press the **ENTER** button.

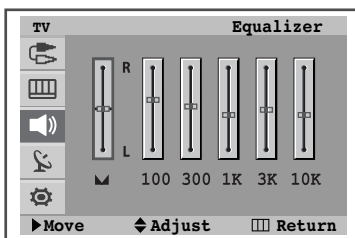

3. Press the **◀** or **▶** button to select a particular frequency to adjust.
Press the **▲** or **▼** button to increase or decrease the level of the particular frequency, then press the **ENTER** button.

Press the **EXIT** button to exit.

- • **L/R Sound Balance Adjustment:**
To adjust the sound balance of the L/R speakers.
- **Bandwidth Adjustment (100, 300, 1K, 3K, 10K):**
To adjust the level of different bandwidth frequencies.
- If you make any changes to the equalizer settings, the sound mode is automatically switched to the “Custom” mode.

Setting the SRS TruSurround XT

TruSurround XT is a patented SRS technology that solves the problem of playing 5.1 multichannel content over two speakers. TruSurround delivers a compelling, virtual surround sound experience through any two-speaker playback system, including internal television speakers. It is fully compatible with all multichannel formats.

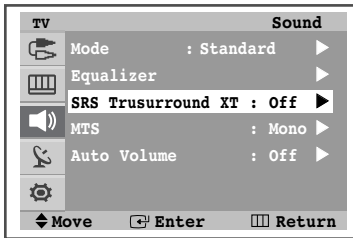

1. Press the **MENU** button to display the menu.
Press the **▲** or **▼** button to select "Sound", then press the **ENTER** button.
2. Press the **▲** or **▼** button to select "SRS TruSurround XT", then press the **ENTER** button.

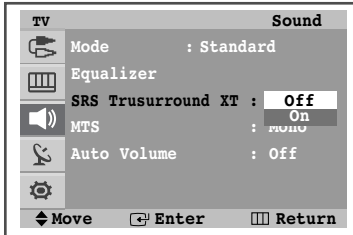

3. Press the **▲** or **▼** button to select "Off" or "On", then press the **ENTER** button.
Press the **EXIT** button to exit.

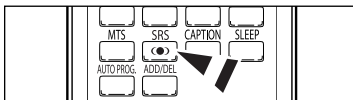

-  Press the **SRS** button on the remote control to select "Off" or "On".

TRADEMARK & LABEL LICENSE NOTICE



TruSurround XT, SRS and  Symbol are trademarks of SRS Labs, Inc.
TruSurround XT technology is incorporated under license from SRS Labs, Inc.

Choosing a Multi-Channel Sound (MTS) track

Multi-Track Sound

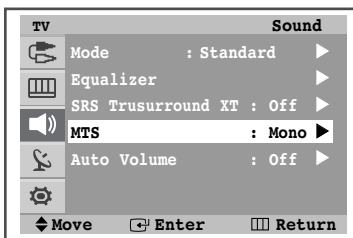

1. Press the **MENU** button to display the menu.
Press the **▲** or **▼** button to select "Sound", then press the **ENTER** button.

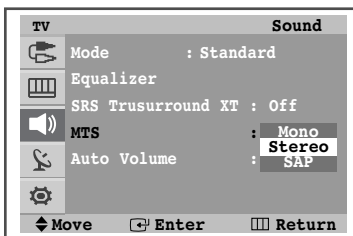

2. Press the **▲** or **▼** button to select "MTS", then press the **ENTER** button.
Press the **▲** or **▼** button to select a setting you want, then press the **ENTER** button.

- Choose **Mono** for channels that are broadcasting in mono, or if you are having difficulty receiving a stereo signal.
- Choose **Stereo** for channels that are broadcasting in stereo.
- Choose **SAP** to listen to the Separate Audio Program, which is usually a foreign-language translation.

Press the **EXIT** button to exit.

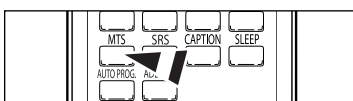

-  Press the **MTS** button on the remote control to select "Mono", "Stereo", or "SAP".

Automatic Volume Control

Reduces the differences in volume level among broadcasters.

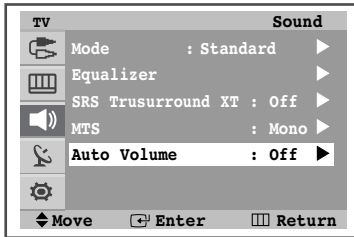

1. Press the **MENU** button to display the menu.
Press the **▲** or **▼** button to select "Sound", then press the **ENTER** button.
2. Press the **▲** or **▼** button to select "Auto Volume", then press the **ENTER** button.

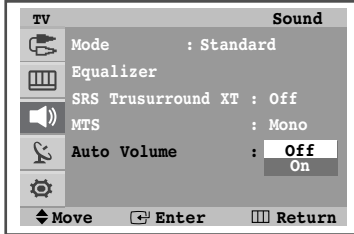

3. Press the **▲** or **▼** button to select "Off" or "On", then press the **ENTER** button.
Press the **EXIT** button to exit.

Channel Control

Adding and Erasing Channels

You can add or delete a channel to display the channels you want only.

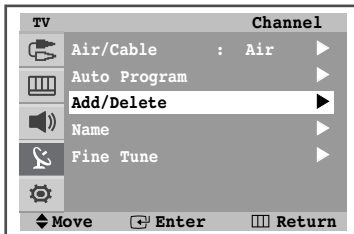

1. Press the **MENU** button to display the menu.
Press the **▲** or **▼** button to select "Channel", then press the **ENTER** button.
2. Press the **▲** or **▼** button to select "Add/Delete", then press the **ENTER** button.

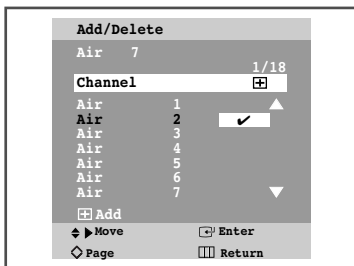

3. Press the **▲** or **▼** button to select the channel to be add or erase.
4. Press the **ENTER** button to move to the (⊕) field.
5. Press the **ENTER** button to add the channel.
The (✓) symbol next to the channel appears and the channel is added.
➤ If you press the **ENTER** button again, the (✓) symbol next to the channel disappears and the channel is not added.
6. Repeat step 3 to 5 for each channel to be added or erased.
Press the **EXIT** button to exit.

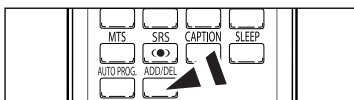

7. Press the **ADD/DEL** button on the remote control.
Press the **CH ^** and **CH v** button to select the channel to be added or deleted, then press the **ENTER** button.

Labeling Channels

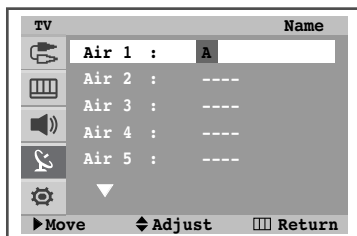
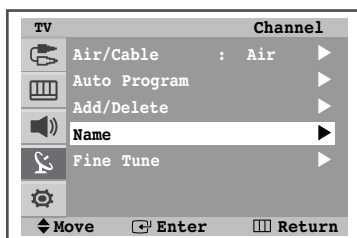

1. Press the **MENU** button to display the menu.
Press the **▲** or **▼** button to select "Channel", then press the **ENTER** button.
 2. Press the **▲** or **▼** button to select "Name", then press the **ENTER** button.
 3. Select the channel to be assigned to a new name by pressing the **▲** or **▼** button.
 4. Press the **ENTER** or **▶** button.
 5. Press the **▲** or **▼** button to select a letter (A~Z), a number (0~9) or a symbol (space, -). Move on to the previous or next letter by pressing the **◀** or **▶** button.
 6. Repeat Steps 3 to 5 for each channel to be assigned to a new name.
Press the **EXIT** button to exit.
- If you add or delete the TV channel, the corresponding label information will also be added or deleted.

Fine Tuning Channel Reception

If the reception is clear, you do not have to fine tune the channel, as this is done automatically during the search and store operation.

If the signal is weak or distorted, you may have to fine tune the channel manually.

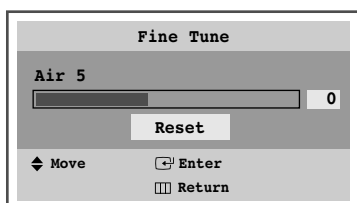
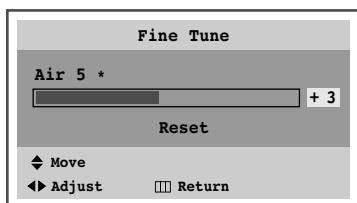
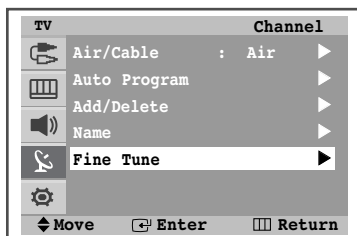

1. Press the **MENU** button to display the menu.
Press the **▲** or **▼** button to select "Channel", then press the **ENTER** button.
2. Press the **▲** or **▼** button to select "Fine Tune", then press the **ENTER** button.
3. To obtain a sharp and clear picture and good sound quality, press the **◀** or **▶** button to reach the required setting.
The channel number is changed to red and marked with a "*".
4. To reset the fine tuning to "0", select "Reset" by pressing the **▲** or **▼** button.
Press the **ENTER** button.
Press the **EXIT** button to exit.

Time Setting

Setting the Time

Setting the clock is necessary in order to use the various timer features of the TV. Also, you can check the time while watching the TV. (Just press the **INFO** button.)

Setting and Displaying the Current Time

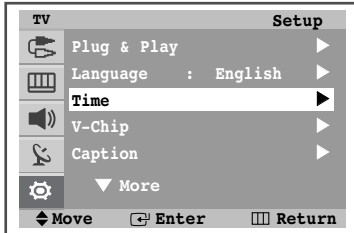

1. Press the **MENU** button to display the menu.
Press the **▲** or **▼** button to select "Setup", then press the **ENTER** button.

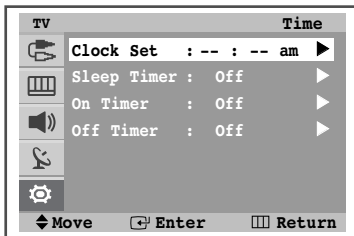

2. Press the **▲** or **▼** button to select "Time", then press the **ENTER** button.
3. Press the **ENTER** button again.

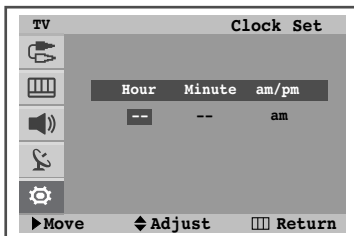

4. Press the **◀** or **▶** button to move to the Hour, Minute or am/pm.
Set these by pressing the **▲** or **▼** button.
 - You can set the hour and minute directly by pressing the numeric buttons on the remote control.
5. Press the **ENTER** button.
Press the **EXIT** button to exit.
 - The current time will appear every time you press the **INFO** button.

Setting the Sleep Timer

You can set your TV to automatically turn off after a preset interval.

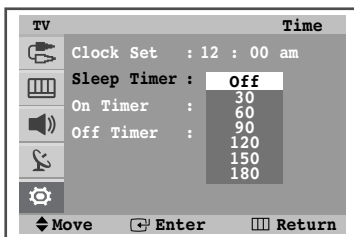

1. Press the **MENU** button to display the menu.
Press the **▲** or **▼** button to select "Setup", then press the **ENTER** button.
2. Press the **▲** or **▼** button to select "Time", then press the **ENTER** button.
3. Press the **▲** or **▼** button to select "Sleep Timer", then press the **ENTER** button.
4. Press the **▲** or **▼** button to select the preset time interval (Off, 30, 60, 90, 120, 150, 180) for staying on, then press the **ENTER** button.
Press the **EXIT** button to exit.

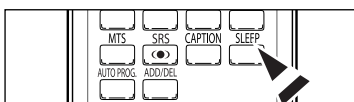

- Press the **SLEEP** button on the remote control until the appropriate time interval appears (any of the preset values from "30 min" to "180 min").

Setting the On/Off Timer

You can preset a time to turn the TV On or Off.

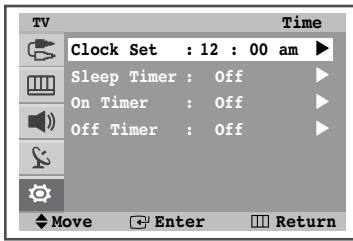

1. Press the **MENU** button to display the menu.
Press the **▲** or **▼** button to select "Setup", then press the **ENTER** button.
2. Press the **▲** or **▼** button to select "Time", then press the **ENTER** button.

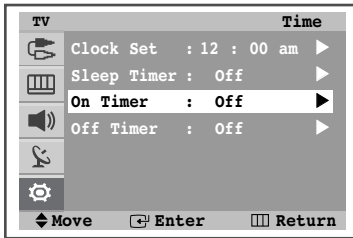

3. Press the **▲** or **▼** button to select "On Timer", then press the **ENTER** button.

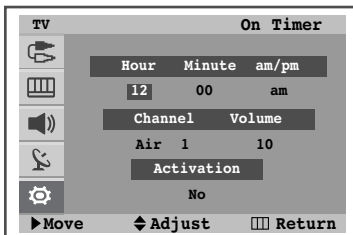

4. Press the **▲** or **▼** button to set the hour, then press the **▶** button to move to the next step.
Set other items using the same method as above.
 - > When finished, press the **MENU** button to return.
 - > You can set the hour, minute directly by pressing the number buttons on the remote control.

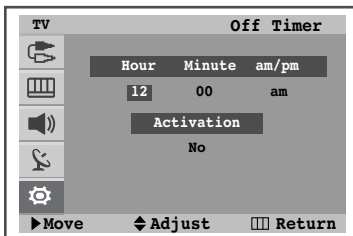

5. Press the **▲** or **▼** button to select "Off Timer", then press the **ENTER** button.
6. Press the **▲** or **▼** button to set the hour, then press the **▶** button to move to the next step.
Set other items using the same method as above.
Press the **EXIT** button to exit.
 - > Auto Power Off
When you set the timer "On", the TV will eventually turn off, if no controls are operated for 3 hours after the TV was turned on by timer. This function is only available in timer "On" mode and prevents overheating, which may occur if a TV is on for too long.

Function Description

Using the V-Chip

The V-Chip feature automatically locks out programs that are deemed inappropriate for children. The user must enter a PIN (personal ID number) before any of the V-Chip restrictions are set up or changed.

Setting Up Your Personal ID Number (PIN)

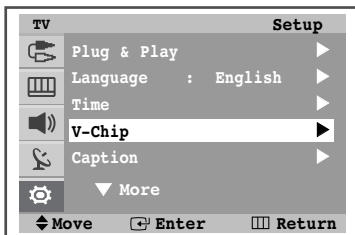

1. Press the **MENU** button to display the menu. Press the **▲** or **▼** button to select "Setup", then press the **ENTER** button.

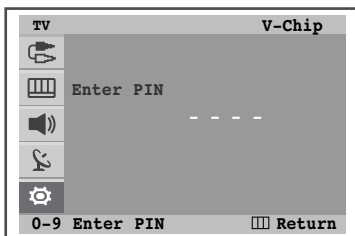

2. Press the **▲** or **▼** button to select "V-Chip", then press the **ENTER** button. The message "Enter PIN" will appear. Enter your 4 digit PIN number.
 - The default PIN number of a new TV set is "0-0-0-0".

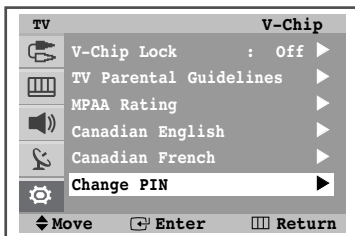

3. The "V-Chip" screen will appear. Press the **▲** or **▼** button to select "Change PIN", then press the **ENTER** button.

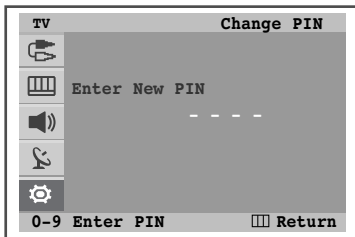

4. The Change PIN screen will appear. Press the number buttons (0 ~ 9) to enter a new password. Re-enter the new password to confirm.

Press the **EXIT** button to exit.

- If you forget the PIN, press the remote control buttons in the following sequence, which resets the pin to 0-0-0-0 : Power Off. → Mute → 8 → 2 → 4 → Power On.

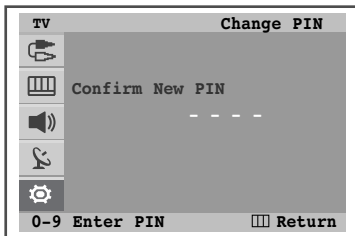

How to Enable/Disable the V-Chip

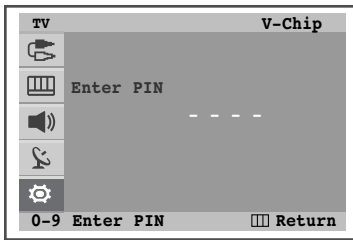

1. Press the **MENU** button to display the menu.
Press the **▲** or **▼** button to select "Setup", then press the **ENTER** button.
2. Press the **▲** or **▼** button to select "V-Chip", then press the **ENTER** button.
The message "Enter PIN" will appear. Enter your 4 digit PIN number.

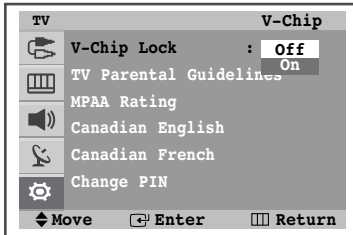

3. The "V-Chip" screen will appear.
To enable the V-Chip feature, press the **ENTER** button so that the "V-Chip Lock" field is "On". (Pressing the **▲** or **▼** button will alternate between "Off" and "On".)
Press the **ENTER** button.
Press the **EXIT** button to exit.

How to Set up Restrictions Using the "TV Parental Guidelines"

First, set up a personal identification number (PIN), and enable the V-Chip. (See previous section.)

Parental restrictions can be set up using either of two methods: The TV guidelines or the MPAA rating.

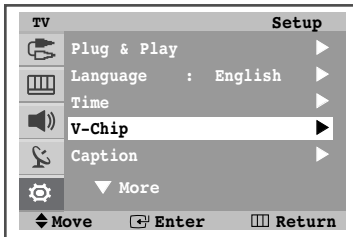

1. Press the **MENU** button to display the menu.
Press the **▲** or **▼** button to select "Setup", then press the **ENTER** button.

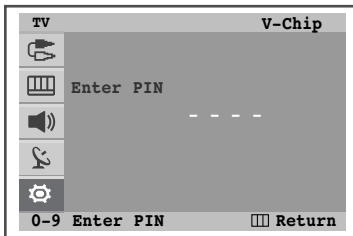

2. Press the **▲** or **▼** button to select "V-Chip", then press the **ENTER** button.
The message "Enter PIN" will appear. Enter your 4 digit PIN number.

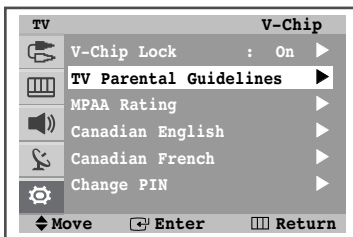

3. The "V-Chip" screen will appear. Press the **▲** or **▼** button to select "TV Parental Guidelines", then press the **ENTER** button.

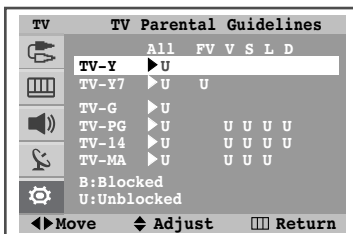

4. The "TV Parental Guidelines" screen will appear.
Press the **▲** or **▼** button to select one of the six aged based categories

- | | |
|------------------------------|------------------------------|
| • TV-Y: Young children | • TV-G: General audience |
| • TV-Y7: Children 7 and over | • TV-PG: Parental guidance |
| | • TV-14: Viewers 14 and over |
| | • TV-MA: Mature audience |

Continued...

5. At this point, one of the TV-Ratings is selected. Press the **ENTER** or **▶** button. Depending on your existing setup, the “B” will be selected. (“U” = Unblocked, “B” = Blocked) While “B” is selected, press the **▲** or **▼** button to block or unblock the category. To select a different TV-Rating, press the **MENU** button and then repeat the process.
- The TV-Y, TV-Y7, TV-G, TV-PG, TV-14 and TV-MA have additional options. See the next step to change any of the following sub-ratings:

- **FV:** Fantasy violence.
- **D:** Sexually suggestive dialog.
- **L:** Adult language.
- **S:** Sexual situation.
- **V:** Violence.

- The V-Chip will automatically block certain categories that are “more restrictive”. For example, if you block “TV-Y” category, then TV-Y7 will automatically be blocked. Similarly, if you block the TV-G category, then all the categories in the “young adult” group will be blocked (TV-Y, TV-Y7, TV-G, TV-PG, TV-14, and TV-MA). The sub-ratings (D, L, S, V) work together similarly. (See next section.)
6. How to set the FV, V, S, L and D sub-ratings. First, select one of these TV-Ratings: TV-Y, TV-Y7, TV-G, TV-PG, TV-14, or TV-MA (See Step 4), and press the **ENTER** or **▶** button. Press **▲** or **▼** to block the sub rating. To select a different TV-Rating, press the **MENU** button and then repeat the process.
- The V-chip will automatically block certain categories that are “More restrictive”. For example, if you block “L” sub-rating in TV-PG, then the “L” sub-ratings in TV-14 and TV-MA will automatically be blocked.

7. Press the **EXIT** button to clear all the screens. (Or proceed to the next section, and set up additional restrictions based on the MPAA codes.)
- These categories consist of two separate groups: TV-Y and TV-Y7 (young children through age 7), and TV-G through TV-MA (everybody else). The restrictions for these two groups work independently; If a household includes very young children as well as young adults, the TV guidelines must be set up separately for each age group.

- **TV-Y:** All children. The themes and elements in this program are specifically designed for a very young audience, including children from ages two to six.
- **TV-Y7:** Directed to older children. The themes and elements in this program may include mild physical or comedic violence, or may frighten children under the age of seven.
- **TV-G:** General audience. It contains little or no violence, no strong language, and little or no sexual dialog or situations.
- **TV-PG:** Parental guidance suggested. This program may contain infrequent coarse language, limited violence, some suggestive sexual dialog and situations.
- **TV-14:** Parents strongly cautioned. This program may contain sophisticated themes, sexual content, strong language and more intense violence.
- **TV-MA:** Mature audiences only. This program may contain mature themes, profane language, graphic violence and explicit sexual content.

How to Set up Restrictions Using the MPAA Ratings: G, PG, PG-13, R, NC-17, X, NR

The MPAA rating system uses the Motion Picture Association of America (MPAA) system, and its main application is for movies. When the V-Chip lock is on, the TV will automatically block any programs that are coded with objectionable ratings (either MPAA or TV-Ratings).

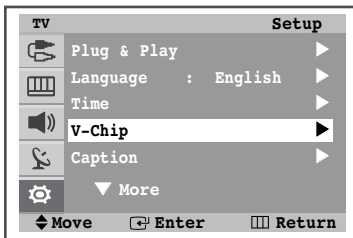

1. Press the **MENU** button to display the menu.
Press the **▲** or **▼** button to select "Setup", then press the **ENTER** button.

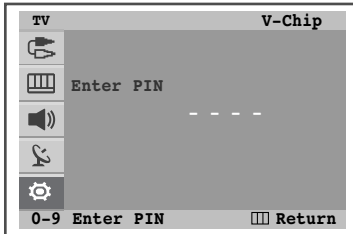

2. Press the **▲** or **▼** button to select "V-Chip", then press the **ENTER** button.
The message "Enter PIN" will appear. Enter your 4 digit PIN number.

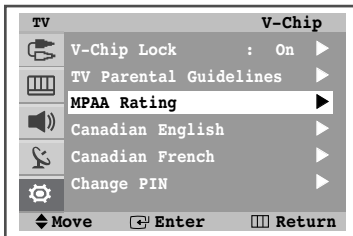

3. The "V-Chip" screen will appear. Press the **▲** or **▼** button to select "MPAA Rating", then press the **ENTER** button.

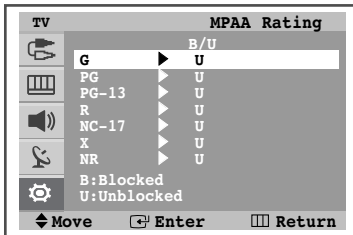

4. Press the **▲** or **▼** button to select one of the categories, then press the **ENTER** or **▶** button. Press the **▲** or **▼** button to select "B" or "U".

- **G:** General audience (no restrictions).
- **PG:** Parental guidance suggested.
- **PG-13:** Parents strongly cautioned.
- **R:** Restricted. Children under 17 should be accompanied by an adult.
- **NC-17:** No children under age 17.
- **X:** Adults only.
- **NR:** Not rated.

Press the **EXIT** button to exit.

- The V-Chip will automatically block any category that is "more restrictive".
For example, if you block the "PG-13" category, then "R", "NC-17" and "X" will automatically be blocked also.

How to Set up Restrictions Using the ‘Canadian English’

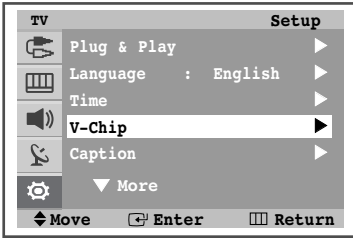

1. Press the **MENU** button to display the menu. Press the **▲** or **▼** button to select “Setup”, then press the **ENTER** button.

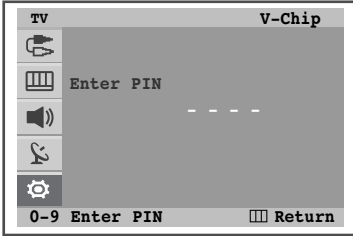

2. Press the **▲** or **▼** button to select “V-Chip”, then press the **ENTER** button. The message “Enter PIN” will appear. Enter your 4 digit PIN number.

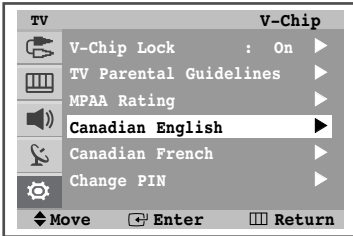

3. The “V-Chip” screen will appear. Press the **▲** or **▼** button to select “Canadian English”, then press the **ENTER** button.

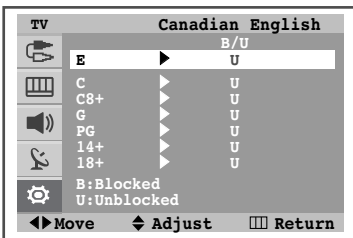

4. Press the **▲** or **▼** button to select one of the categories, then press the **ENTER** or **▶** button. Press the **▲** or **▼** button to select “B” or “U”.

- **E:** Exempt programming includes...news, sports, documentaries and other information programming, talk shows, music videos, and variety programming.
- **C:** Programming intended for children under age 8.
- **C8+:** Programming generally considered acceptable for children 8 years and over to watch on their own.
- **G:** General programming, suitable for all audiences.
- **PG:** Parental Guidance.
- **14+:** Programming contains themes or content which may not be suitable for viewers under the age of 14.
- **18+:** Adult programming.

Press the **EXIT** button to exit.

- The V-Chip will automatically block any category that is “more restrictive”. For example, if you block “G” category, then “PG”, “14+” and “18+” will automatically be blocked also.

How to Set up Restrictions Using the ‘Canadian French’

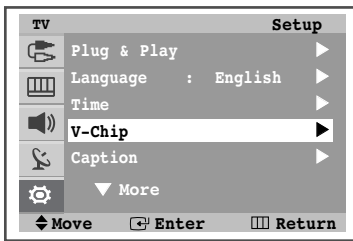

1. Press the **MENU** button to display the menu. Press the **▲** or **▼** button to select “Setup”, then press the **ENTER** button.

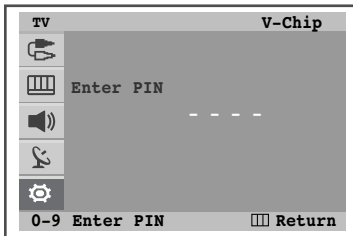

2. Press the **▲** or **▼** button to select “V-Chip”, then press the **ENTER** button. The message “Enter PIN” will appear. Enter your 4 digit PIN number.

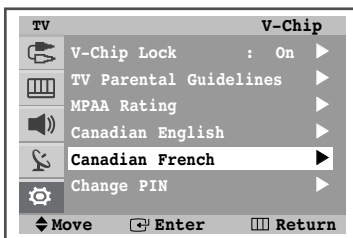

3. The “V-Chip” screen will appear. Press the **▲** or **▼** button to select “Canadian French”, then press the **ENTER** button.

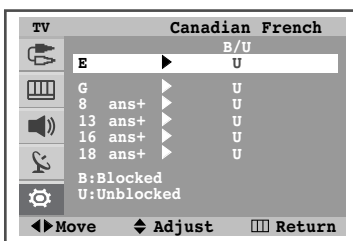

4. Press the **▲** or **▼** button to select one of the categories, then press the **ENTER** or **▶** button. Press the **▲** or **▼** button to select “B” or “U”.

- **E:** Exempt programming includes...news, sports, documentaries and other information programming, talk shows, music videos, and variety programming.
- **G:** General.
- **8 ans+:** Not recommended for young children.
- **13 ans+:** Programming may not be suitable for children under the age of 13.
- **16 ans+:** Programming is not suitable for children under the age of 16.
- **18 ans+:** Programming restricted to adults.

Press the **EXIT** button to exit.

- The V-Chip will automatically block any category that is “more restrictive”. For example, if you block “8 ans+” category, then “13 ans+”, “16 ans+” and “18 ans+” will automatically be blocked also.

Viewing Closed Captions(On-Screen Text Messages)

The Caption function operates in either analog RF channel mode or external signal mode. (Depending on the broadcasting signal, the Caption function may operate on digital channels.)

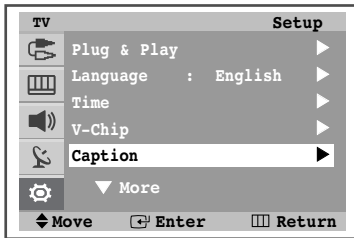

1. Press the **MENU** button to display the menu.
Press the **▲** or **▼** button to select "Setup", then press the **ENTER** button.
2. Press the **▲** or **▼** button to select "Caption", then press the **ENTER** button.

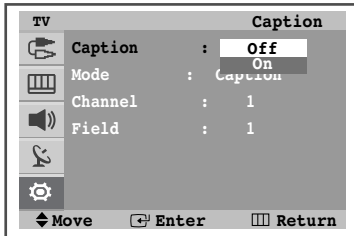

3. Press the **ENTER** button to select "Caption".
Press the **▲** or **▼** button to select "On", then press the **ENTER** button.

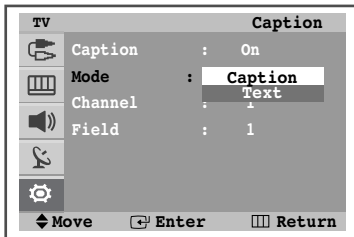

4. Press the **▲** or **▼** button to select "Mode", then press the **ENTER** button.
Press the **▲** or **▼** button to select "Caption" or "Text", then press the **ENTER** button.
 - In "Caption" mode, captions appear at the bottom of the screen, and they usually cover only a small portion of the picture.
 - In "Text" mode, information unrelated to the program, such as news or weather, is displayed. Text often covers a large portion of the screen.

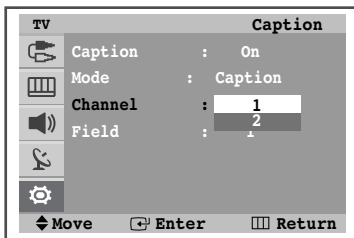

5. Press the **▲** or **▼** button to select "Channel", then press the **ENTER** button.
Press the **▲** or **▼** button to select "1" or "2", then press the **ENTER** button.

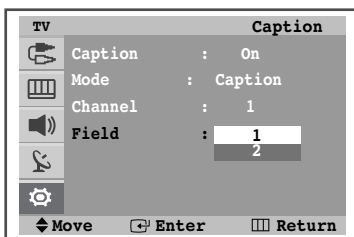

6. Press the **▲** or **▼** button to select "Field", then press the **ENTER** button.
Press the **▲** or **▼** button to select "1" or "2", then press the **ENTER** button.
 - • Different channels and fields display different information: Field 2 carries additional information that supplements the information in Field 1.
(For example, Channel 1 may have subtitles in English, while Channel 2 has subtitles in Spanish.)
 - The availability of captions depends on the program being broadcast.

Press the **EXIT** button to exit.

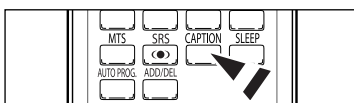

- Press the **CAPTION** button on the remote control to select "On" or "Off".

Selecting a Menu Language

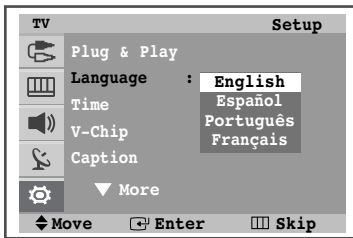

1. Press the **MENU** button to display the menu.
Press the **▲** or **▼** button to select "Setup", then press the **ENTER** button.
2. Press the **▲** or **▼** button to select "Language", then press the **ENTER** button.
Press the **▲** or **▼** button to select the appropriate language: "English", "Español", "Português", or "Français", then press the **ENTER** button.
Press the **EXIT** button to exit.

Setting the Blue Screen Mode

If no signal is being received or the signal is very weak, a blue screen automatically replaces the noisy picture background. If you wish to continue viewing the poor picture, you must set the "Blue Screen" mode to "Off"

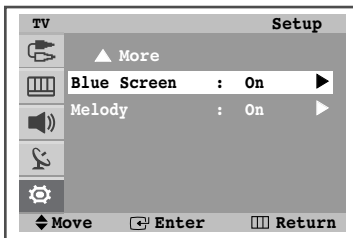

1. Press the **MENU** button to display the menu.
Press the **▲** or **▼** button to select "Setup", then press the **ENTER** button.
2. Press the **▲** or **▼** button to select "Blue Screen", then press the **ENTER** button.
Press the **▲** or **▼** button to select "Off" or "On", then press the **ENTER** button.
Press the **EXIT** button to exit.

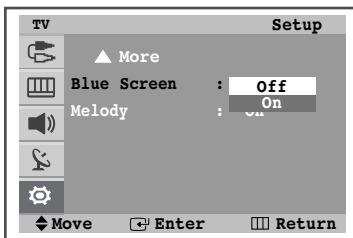

Setting the On/Off Melody

A melody sound can be set to come on when the TV is powered On or Off.

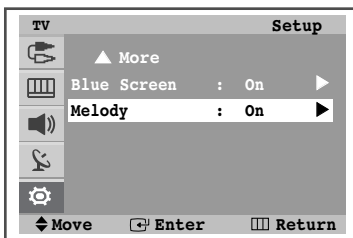

1. Press the **MENU** button to display the menu.
Press the **▲** or **▼** button to select "Setup", then press the **ENTER** button.
2. Press the **▲** or **▼** button to select "Melody", then press the **ENTER** button.
Press the **▲** or **▼** button to select "Off" or "On", then press the **ENTER** button.
Press the **EXIT** button to exit.

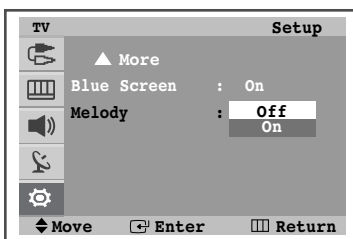

Appendix

Identifying Problems

If the TV seems to have a problem, first try this list of possible problems and solutions.
If none of these troubleshooting tips apply, call your nearest Samsung service center.

Problem	Possible Solution
Poor picture	Try another channel. Adjust the antenna. Check all wire connections.
Poor sound quality.	Try another channel. Adjust the antenna.
No picture or sound.	Try another channel. Press the SOURCE button. Make sure the TV is plugged in. Check the antenna connections. Make sure the MUTE button is off.
No sound or sound is too low at maximum volume.	First, check the volume of units connected to your TV (digital broadcasting receiver, DVD, cable broadcasting receiver, VCR, etc.). Then, adjust the TV volume accordingly.
Picture rolls vertically.	Check all wire connections.
The TV operates erratically.	Unplug the TV for 30 seconds, then try operating it again.
The TV won't turn on.	Make sure the wall outlet is working.
Remote control malfunctions	Replace the remote control batteries. Clean the upper edge of the remote control (transmission window). Check the battery terminals. Make sure the remote has batteries. Check that the "+" and "-" ends of the batteries are inserted correctly.
The image is too light or too dark.	Adjust the Brightness and Contrast. Adjust the Fine tuning.

Specifications

Model Name	TX-S3064WR	TX-S3065WR
Voltage	AC110 - 120 V	
Frequency of Operation	60 Hz	
Dimensions (W x D x H)	31.34 x 16.34 x 23.07 inches (796 x 415 x 586 mm)	35.83 x 16.34 x 22.44 inches (910 x 415 x 570 mm)
Weight	120.1 lbs (54 kg)	120.1 lbs (53.2 kg)



Contact SAMSUNG WORLD-WIDE

If you have any questions or comments relating to Samsung products, please contact the SAMSUNG customer care center.

Country	Customer Care Center ☎	Web Site	Address
CANADA	1-800-SAMSUNG (7267864)	www.samsung.com/ca	Samsung Electronics Canada Inc., Customer Service 55 Standish Court Mississauga, Ontario L5R 4B2 Canada
			Samsung Electronique Canada Inc., Service à la Clientèle 55 Standish Court Mississauga, Ontario L5R 4B2 Canada
U.S.A	1-800-SAMSUNG (7267864)	www.samsung.com	Samsung Electronics America, Inc. 105 Challenger Road Ridgefield Park, NJ 07660-0511