

SAMSUNG

**CL21M2
CL21M6
CL21M21
CL21T21**

COLOR TELEVISION



**Owner's
Instructions**

Register your product at www.samsung.com/global/register

Important Warranty Information Regarding Television Format Viewing

Standard screen format televisions (4:3, the aspect ratio of the screen width to height) are primarily designed to view standard format full-motion video. The images displayed on them should primarily be in the standard 4:3 ratio format and constantly moving. Displaying stationary graphics and images on screen, such as the dark top and bottom letterbox bars (wide screen pictures), should be limited to no more than 15% of the total television viewing per week.

Wide screen format televisions (16:9, the aspect ratio of the screen width to height) are primarily designed to view wide screen format full-motion video. The images displayed on them should primarily be in the wide screen 16:9 ratio format, or expanded to fill the screen if your model offers this feature, and constantly moving. Displaying stationary graphics and images on screen, such as the dark side-bars on non-expanded standard format television video and programming, should be limited to no more than 15% of the total television viewing per week.

Additionally, viewing other stationary images and text such as stock market reports, video game displays, station logos, web sites or computer graphics and patterns, should be limited as described above for all televisions. Displaying any stationary images that exceed the above guidelines can cause uneven aging of picture tubes (CRTs) that leave subtle, but permanent burned-in ghost images in the television picture. To avoid this, vary the programming and images, and primarily display full screen moving images, not stationary patterns or dark bars. On television models that offer picture sizing features, use these controls to view the different formats as a full screen picture.

Be careful in the selection and duration of television formats used for viewing. Uneven CRT aging as a result of format selection and use, as well as other burned-in images, is not covered by your Samsung limited warranty.

Chapter 1: Your New TV	5
List of Features	5
Accessories	5
Familiarizing Yourself with the TV.....	6
Control Buttons	6
Connection Jacks (Side).....	7
Connection Jacks (Rear)	8
Remote Control	9
Installing Batteries in the Remote Control.....	10
 Chapter 2: Installation.....	 11
Connecting VHF and UHF Antennas.....	11
Antennas with 300-ohm Flat Twin Leads.....	11
Antennas with 75-ohm Round Leads.....	12
Separate VHF and UHF Antennas.....	12
Connecting Cable TV	13
Cable without a Cable Box	13
Connecting to a Cable Box that Descrambles All Channels	13
Connecting to a Cable Box that Descrambles Some Channels.....	14
Connecting a VCR.....	15
Connecting a Second VCR to Record from the TV	15
Connecting a DVD Player.....	16
Connecting to Y, PB, PR.....	16
Connecting to Regular Audio and Video Jacks.....	16
Connecting a Camcorder.....	17
Connecting to an Analog Amplifier.....	17
 Chapter 3: Operation.....	 18
Turning the TV On and Off	18
Plug & Play Feature.....	18
Viewing the Menus and On-Screen Displays.....	20
Viewing the Menus.....	20
Viewing the Display.....	20
Selecting a Menu Language.....	21
Memorizing the Channels.....	22
Selecting the Video Signal Source	22
Storing Channels in Memory (Automatic Method)	23
Adding and Erasing Channels.....	24
Changing Channels	25
Using the Channel Buttons	25
Using the Number Buttons	25
Using the PRE-CH Button to Select the Previous Channel	25
Labelling the Channels	26
Picture Control.....	27
Using Automatic Picture Settings.....	27
Customizing the Picture	28
Resetting the Picture Settings to the Factory Defaults.....	29

continued...

Chapter 3: Operation	30
Sound Control	30
Adjusting the Volume	30
Using the MUTE Button	30
Using Automatic Sound Settings	31
Customizing the Sound	32
Setting the Clock	33
Viewing an External Signal Source	34
Setting the Signal Source	34
Assigning Names to External Input Mode	35
Chapter 4: Special Features	36
Fine Tuning Channels	36
Changing the Screen Size	37
Digital Noise Reduction	38
DNle JrTM (Digital Natural Image engine)  (depending on the model)	39
Viewing Picture-In-Picture (depending on the model)	40
Activating the PIP	40
Selecting an External Source	41
Swapping the Sub Picture and Main Picture	41
Changing the Size of the Sub Picture	41
Changing the Position of the Sub Picture	42
Changing the Channel of the Sub Picture	42
Using the R.Surf Feature	43
Choosing a Multi-Channel Sound (MTS) track	44
Extra Sound Settings (Auto Volume, Pseudo Stereo, or Turbo Plus)	45
Setting the On/Off Timer	46
Setting the Preferred Channel and Volume Level	47
Setting the Sleep Timer	48
Viewing Closed Captions (On-Screen Text Message)	49
Locking the Channel (depending on the model)	51
Setting the Blue Screen Mode	52
Setting the On/Off Melody	53
Viewing the Demonstration	54
Chapter 5: Troubleshooting	55
Identifying Problems	55
Appendix	56
Cleaning and Maintaining Your TV	56
Using Your TV in Another Country	56
Specifications	56

Chapter One

YOUR NEW TV

List of Features

Your TV is designed with the latest technology. This TV is a high-performance unit that includes the following special features:

- Easy-to-use remote control
- Easy-to-use on-screen menu system
- Automatic timer to turn the TV on and off
- Adjustable picture and sound settings that can be stored in the TV's memory
- Automatic channel tuning for up to 181 channels
- A special filter to reduce or eliminate reception problems
- A built-in multi-channel sound decoder for stereo and bilingual listening
- Built-in, dual channel speakers
- A special sleep timer
- Picture-In-Picture (depending on the model)

Accessories

Once you have unpacked your TV, check to make sure that you have all the parts shown here. If any piece is missing or broken, call your dealer.



Remote Control/
AAA Batteries



Owner's Instructions/
Safety Guide Manual



Warranty Card/
Registration Card

Familiarizing Yourself with the TV

Control Buttons

You can control your TV's basic features, including the on-screen menu. To use the more advanced features, you must use the remote control.

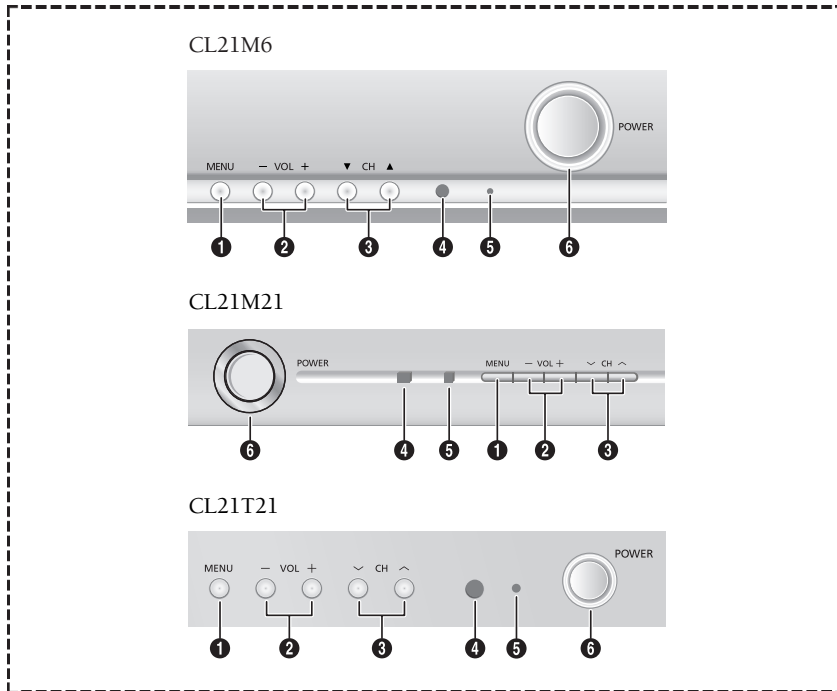

1 MENU

Press to see an on-screen menu of your TV's features.

2 - VOL +

Press to increase or decrease the volume. Also used to select items on the on-screen menu.

3 √(▼) CH ^ (▲)

Press to change channels. Also press to move between items on the on-screen menu.

4 Remote Control Sensor

Aim the remote control towards this spot on the TV.

5 Indicator

(depending on the model)

- Stand-By ; Red
Lights up when you turn the power off.
- Power Off ; Red
- Power On ; Off
- TIMER ; Green
When the TV is turned on, the TIMER indicator blinks five times. This indicator illuminates when the TIMER mode is set to the "On" position after setting the clock and either the On timer or Off timer, with the remote control. Even if the power is turned off, this indicator stays lit. (Clock must be set before using this function.)

6 POWER

Press to turn the TV on and off.

Connection Jacks (Side)

You can connect an A/V component that is used only occasionally, such as a camcorder or video game. (For information on connecting equipment, see page 17.)

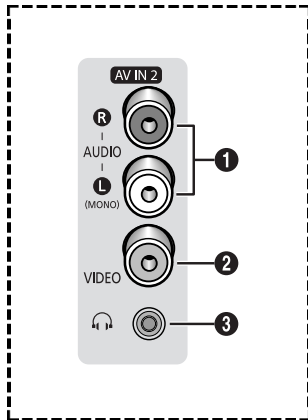

1 AUDIO Input

Connect audio signals from a camcorder or video game.

2 VIDEO Input

Connect a video signal from a camcorder or video game.

3 Headphone

Connect a set of external headphones to this jack for private listening.

- Please be sure to match the color coded input terminals and cable jacks.

Connection Jacks (Rear)

Use the rear panel jacks to connect an A/V component that will be connected continuously, such as a VCR or a DVD player.

For more information on connecting equipment, see pages 11~17.

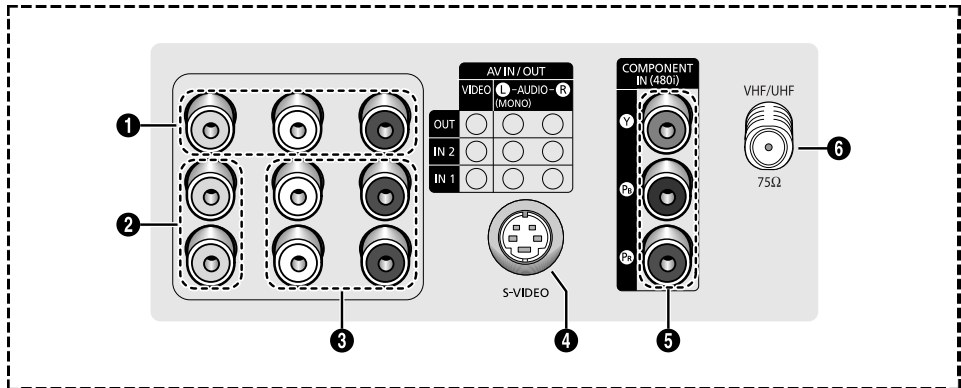

- Please be sure to match the color coded input terminals and cable jacks.

❶ Audio-Video Output jacks

Connect to the audio/video input jacks of a recording VCR.

❷ Video Input jacks

Connect to the video output jacks of VCRs, DVD players and similar devices.

❸ Audio Input jacks

Connect to the audio output jacks of VCRs, DVD players and similar devices.

When using the S-Video or Component Video input, connect audio jacks to "AV IN 2 (AUDIO-L/R)".

❹ S-Video Input jack

(depending on the model)

Connect to S-Video output jack of an S-VHS VCR or DVD player.

❺ Component Video Input jacks (Y, PB, PR)

Connect to the Component audio and video outputs of DVD or DTV set-top box. 480i video signal input is available.

❻ VHF/UHF

Connect to an antenna or to a cable TV system.

Remote Control

You can use the remote control up to about 23 feet from the TV. When using the remote, always point it directly at the TV.

- 1 POWER**
Turns the TV on and off.
- 2 Number buttons**
Press to select channels directly on the TV.
- 3 +100**
Press to select channels over 100. For example, to select channel 121, press "+100", then press "2" and "1".
- 4 MUTE**
Press to temporarily cut off the sound.
- 5 VOL +, VOL -**
Press to increase or decrease the volume.
- 6 SLEEP**
Press to select a preset time interval for automatic shut off. (Refer to page 48)
- 7 MENU**
Displays the main on-screen menu.
- 8 ▲/▼/◀/▶**
Controls the cursor in the menu.
- 9 ENTER**
While using the on-screen menus, press ENTER to activate (or change) a particular item.

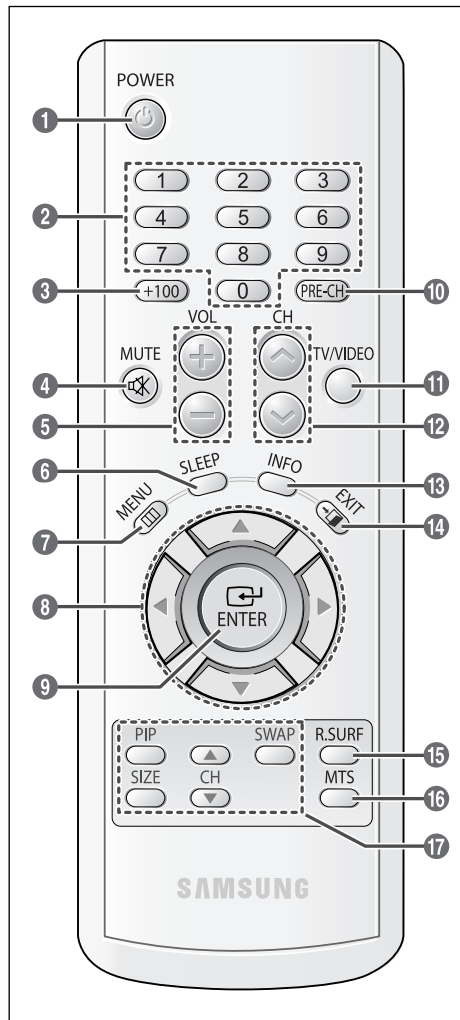

- 10 PRE-CH**
Tunes to the previous channel.
- 11 TV/VIDEO**
Press to display all of the available video sources.
- 12 CH ^, CH v**
Press to change channels.
- 13 INFO**
Press to display information on the TV screen.
- 14 EXIT**
Press to exit the menu.
- 15 R.SURF**
Press to automatically return to a preferred channel after a user-preset time delay. (Refer to page 43)
- 16 MTS**
(Multi-channel Television Sound)
Press to choose "Stereo", "Mono", or "SAP" (Secondary Audio Program). (Refer to page 44)
- 17 PIP Controls**
(depending on the model, refer to pages 40-42)
 - PIP**
Press to activate or deactivate the PIP function.
 - SWAP**
Press to interchange the main picture and sub-picture.
 - SIZE**
Press to select a size ("Large" or "Small") of the sub-picture.
 - CH**
Press to select a channel of the sub-picture only when the "Source" is set to "TV".

Installing Batteries in the Remote Control

1

Slide the cover out completely.

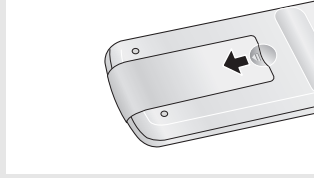

2

Install two AAA size batteries.

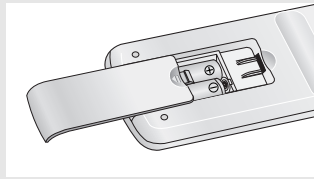

◀ Make sure to match the “+” and “-” ends of the batteries with the diagram inside the compartment.

3

Replace the cover.

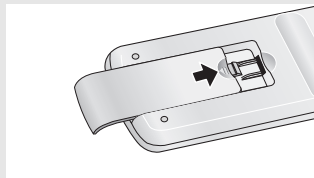

◀ Remove the batteries and store them in a cool, dry place if you won't be using the remote control for a long time.

The remote control can be used up to about 23 feet from the TV. (Assuming typical TV usage, the batteries last for about one year.)

Chapter Two

INSTALLATION

Connecting VHF and UHF Antennas

If your antenna has a set of leads that look like this, see “Antennas with 300-ohm Flat Twin Leads” below.



If your antenna has one lead that looks like this, see “Antennas with 75-ohm Round Leads” on the next page.



If you have two antennas, see “Separate VHF and UHF Antennas” on the next page.

Antennas with 300-ohm Flat Twin Leads

If you are using an off-air antenna (such as a roof antenna or “rabbit ears”) that has 300-ohm twin flat leads, follow the directions below.

1

Place the wires from the twin leads under the screws on the 300-75 ohm adaptor (not supplied). Use a screwdriver to tighten the screws.

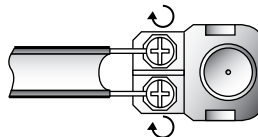

2

Plug the adaptor into the “VHF/UHF” terminal on the rear panel.

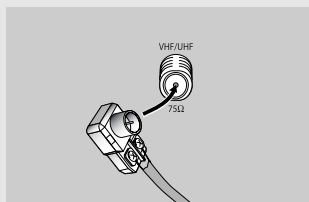

Antennas with 75-ohm Round Leads

- 1 Plug the antenna lead into the "VHF/UHF" terminal on the rear panel.

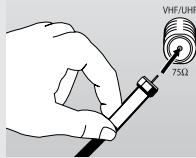

Separate VHF and UHF Antennas

If you have two separate antennas for your TV (one VHF and one UHF), you must combine the two antenna signals before connecting the antennas to the TV. This procedure requires an optional combiner-adaptor (available at most electronics shops).

- 1 Connect both antenna leads to the combiner.

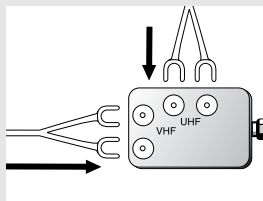

- 2 Plug the combiner into the "VHF/UHF" terminal on the rear panel.

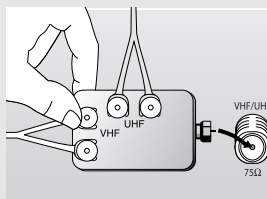

Connecting Cable TV

To connect to a cable TV system, follow the instructions below.

Cable without a Cable Box

1

Plug the incoming cable into the "VHF/UHF" terminal on the rear panel.

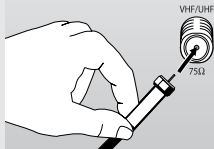

Connecting to a Cable Box that Descrambles All Channels

1

Find the cable that is connected to the ANTENNA OUT terminal on your cable box.



◀ This terminal might be labelled "ANT OUT", "VHF OUT" or simply, "OUT".

2

Connect the other end of this cable to the "VHF/UHF" terminal on the rear panel.



Connecting to a Cable Box that Descrambles Some Channels

If your cable box descrambles only some channels (such as premium channels), follow the instructions below. You will need a two-way splitter, an RF (A/B) switch, and four lengths of coaxial cable. (These items are available at most electronics stores.)

1

Find and disconnect the cable that is connected to the ANTENNA IN terminal on your cable box.

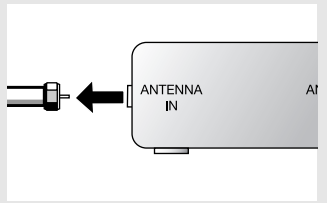

◀ This terminal might be labelled “ANT IN”, “VHF IN” or simply, “IN”.

2

Connect this cable to a two-way splitter. Connect a coaxial cable between an OUTPUT terminal on the splitter and the IN terminal on the cable box.

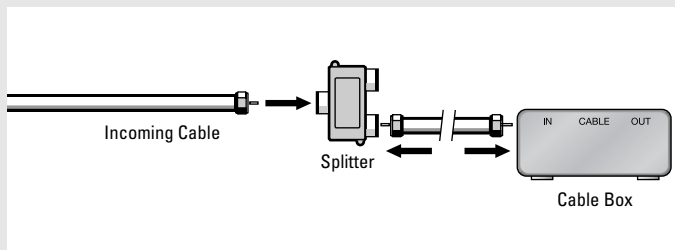

3

Connect a coaxial cable between the ANTENNA OUT terminal on the cable box and the B-IN terminal on the RF(A/B) switch.

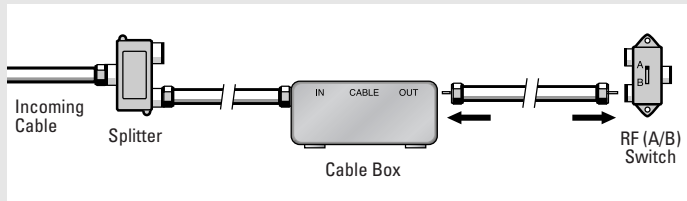

4

Connect another cable between the other OUT terminal on the splitter and the A-IN terminal on the RF (A/B) switch.

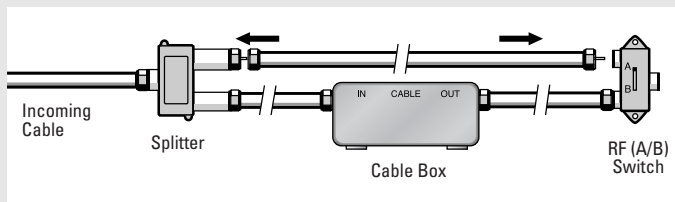

5

Connect the last coaxial cable between the OUT terminal on the RF (A/B) switch and the “VHF/UHF” terminal on the rear panel.

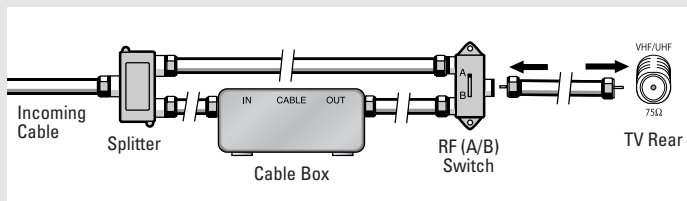

After you've made this connection, set the A/B switch to the "A" position for normal viewing. Set the A/B switch to the "B" position to view scrambled channels. (When you set the A/B switch to "B", you will need to tune your TV to the cable box's output channel, which is usually channel 3 or 4.)

Connecting a VCR

These instructions assume that you have already connected your TV to an antenna or a cable TV system (according to the instructions on pages 11~14).

1

Connect a coaxial cable between the “VHF/UHF” terminal on the TV and the antenna out terminal on the VCR.

A coaxial cable is usually included with a VCR. (If not, check your local electronics store).

2

Connect a set of audio cables between the “AV IN 1 (L, R)” (or “AV IN 2 (L, R)”) jacks on the TV and AUDIO OUT jacks on the VCR. If you have a mono VCR, connect L(mono) to VCR audio out using only one audio cable.

3

Connect a video cable between the “AV IN 1 (VIDEO)” (or “AV IN 2 (VIDEO)”) jack on the TV and the VIDEO OUT jack on the VCR.

Refer to your VCR’s instructions for more information about how to view your VCR tape.

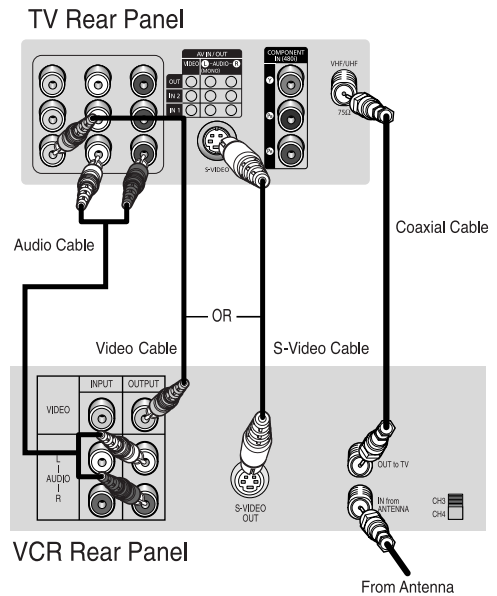

- Also, you can connect to “AV IN 2” on the side panel of TV.

Connecting a Second VCR to Record from the TV

Your TV can send out signals of its picture and sound to be recorded by a second VCR. To do this, connect your second VCR as follows:

1

Connect a set of audio cables between the “AV OUT (L, R)” jacks on the TV and AUDIO IN jacks on the VCR. The VCR input jacks might be either on the front or on back of the VCR.

The VCR input jacks might be either on the front or on back of the VCR.

2

Connect a video cable between the “AV OUT (VIDEO)” jack on the TV and the VIDEO IN jack on the VCR.

Refer to your VCR’s instructions for more information about how to record using this kind of connection.

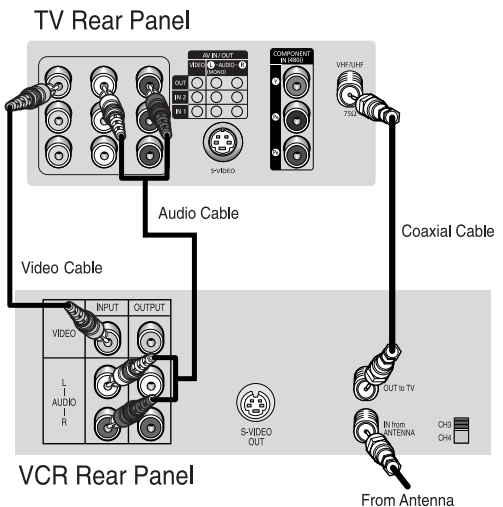

Connecting a DVD Player

The rear panel jacks on your TV make it easy to connect a DVD player to your TV.

Connecting to Y, PB, PR

1

Connect a set of audio cables between the “AV IN 2 (L, R)” jacks on the TV and the AUDIO OUT jacks on the DVD player.

2

Connect a set of video cables between the “COMPONENT IN (Y, PB, PR)” jacks on the TV and the COMPONENT VIDEO OUT (Y, PB, PR) jacks on the DVD player. For an explanation of Component video, see your DVD player’s owner’s instruction.

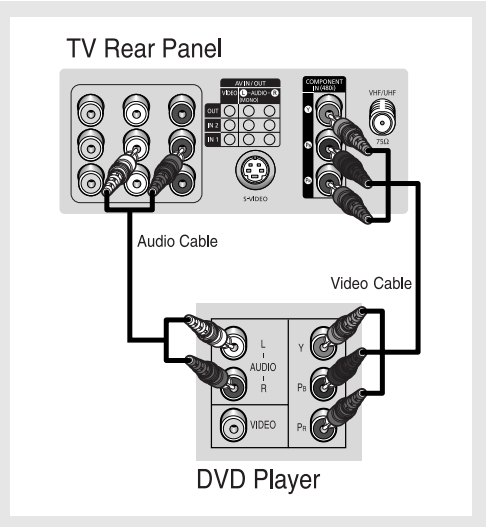

Connecting to Regular Audio and Video Jacks

1

Connect a set of audio cables between the “AV IN 1 (L, R)” (or “AV IN 2 (L, R)”) jacks on the TV and the AUDIO OUT jacks on the DVD player.

2

Connect a video cable between the “AV IN 1 (VIDEO)” (or “AV IN 2 (VIDEO)”) jack on the TV and the VIDEO OUT jack on the DVD player.

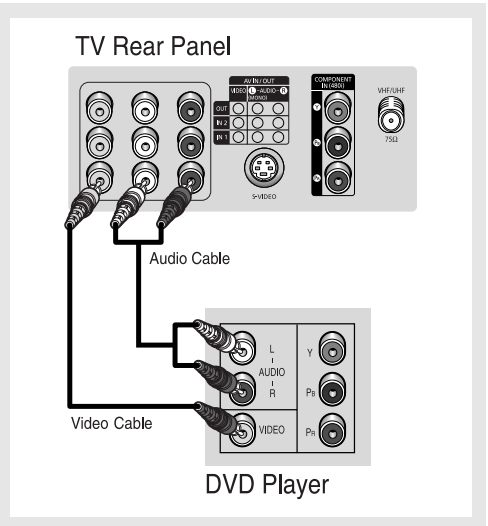

- Also, you can connect to “AV IN 2” on the side panel of TV.

Connecting a Camcorder

The side panel jacks on your TV make it easy to connect a Camcorder to your TV. They allow you to view the Camcorder tapes without using a VCR.

1

Locate the A/V output jacks on the Camcorder. They are usually found on the side or rear of the Camcorder.

2

Connect a set of audio cables between the “AV IN 2 (L, R)” jacks on the TV and the AUDIO OUT jacks on the Camcorder.

If you have mono Camcorder, connect L(mono) to Camcorder audio out using only one audio cable.

3

Connect a video cable between the “AV IN 2 (VIDEO)” jack on the TV and the VIDEO OUT jacks on the Camcorder.

The audio-video cables shown here are usually included with a Camcorder. (If not, check your local electronics store.) If your Camcorder is stereo, you need to connect a set of two cables.

TV Side Panel

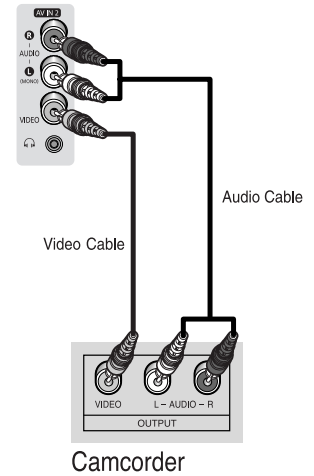

Connecting to an Analog Amplifier

The “AV OUT (L, R)” jacks cannot be used for external speakers. You must hook them up to an amplifier.

When an audio amplifier is connected to the “AV OUT (L, R)” jacks: Decrease the gain (volume) of the audio amplifier, and adjust the volume level with the volume control on the TV.

TV Rear Panel

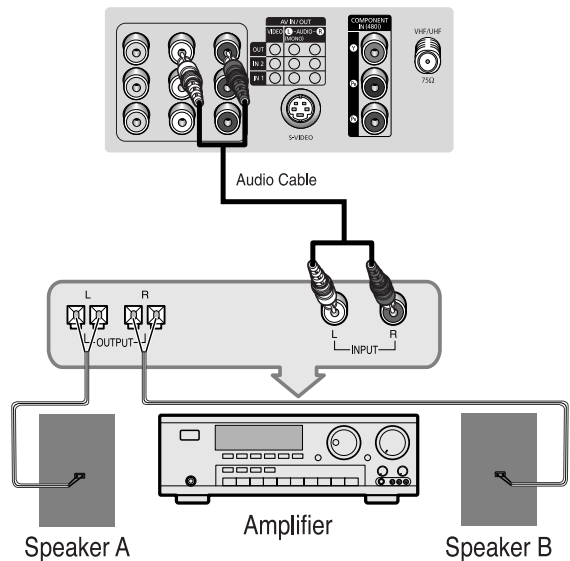

Chapter Three

OPERATION

Turning the TV On and Off

Press the **POWER** button.
You can also use the **POWER** button on the front panel.

Plug & Play Feature

When the TV is initially powered On, basic customer settings proceed automatically and subsequently: Setting the language, Antenna input check, Channel Memorize and Time Setting.

- The Plug & Play function operates after plugging in the TV for the first time.

1

Press the **POWER** button on the remote control.

The "Start Plug & Play" is displayed.
Press the **ENTER** button, then the "Language" is displayed.

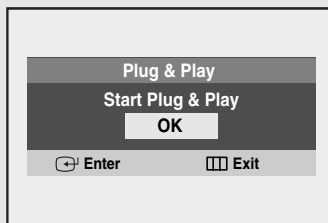

◀ Plug & Play feature doesn't work in the AV mode.

2

Press the **▲** or **▼** button to select the desired language, then press the **ENTER** button.
The "Check antenna input." is displayed.



3

Make sure that the antenna is connected to the TV.
Press the **ENTER** button, then the "Auto Program" is displayed.

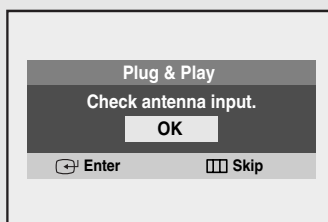

4

Press the **ENTER** button to start.
The TV begins memorizing all available channels.



5

Press the **ENTER** button to stop.



6

After all available channels are stored, the "Clock Set" is displayed.
Press the ◀ or ▶ button to move to the hour or minute.
Set the clock by pressing the ▲ or ▼ button.

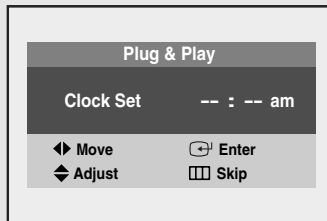

◀ Refer to "Setting the Clock" on page 33.

7

When you have finished, press the **MENU** button.
The "Enjoy your watching." is displayed.

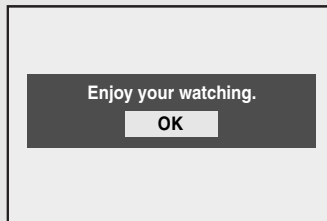

8

If you want to reset this feature

- (1) Press the **MENU** button.
- (2) Press the ▲ or ▼ button to select "Setup", then press the **ENTER** button.
The "Plug & Play" is selected.
- (3) Press the **ENTER** button.
The "Start Plug & Play" is displayed.

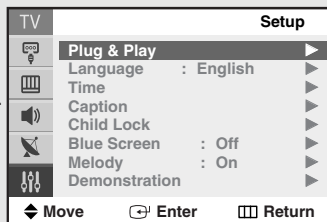

Viewing the Menus and On-Screen Displays

Viewing the Menus

1

With the power on, press the **MENU** button.
The "Input" menu appears on the screen. Its left side has five icons: Input, Picture, Sound, Channel, and Setup.

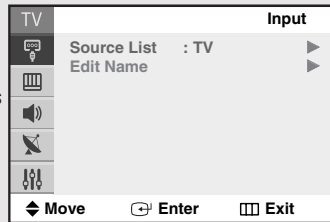

Press the **▲** or **▼** button to select one of the five icons. Then press the **ENTER** button to access the icon's sub-menu.

2

Press the **▲** or **▼** button to move to items in the menu (the icon is selected).
Press the **ENTER** or **▶** button to enter items in the menu.
Press the **▲/▼/◀/▶** button to change the selected items.
Press the **MENU** or **◀** button to return to the previous menu.

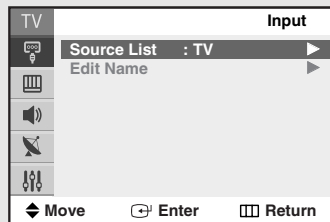

◀ You can also use the **MENU**, **VOL+/-** and **CH▲/▼** buttons on the control panel of the TV to make selections.

3

Press the **EXIT** button to exit.

Viewing the Display

The display identifies the current channel and the status of certain audio-video settings.

Press the **INFO** button on the remote control.
The TV displays the current channel, the status of certain picture and sound settings and the current time.

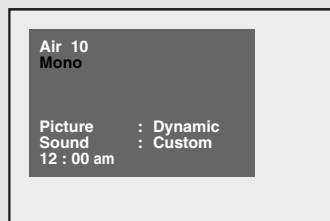
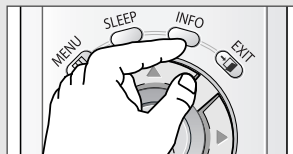

Selecting a Menu Language

1

Press the **MENU** button.

Press the **▲** or **▼** button to select "Setup", then press the **ENTER** button.

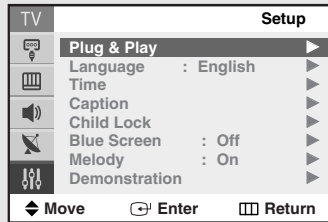

2

Press the **▲** or **▼** button to select "Language", then press the **ENTER** button.

Press the **▲** or **▼** button to select "English", "Español", "Português", or "Français", then press the **ENTER** button.

Press the **EXIT** button to exit.

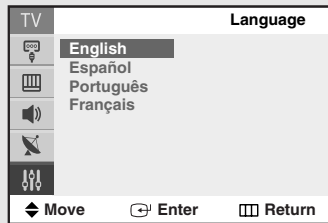

Memorizing the Channels

Your TV can memorize and store all of the available channels for both “off-air” (antenna) and cable channels. After the available channels are memorized, use the **CH \wedge** and **CH \vee** buttons to scan through the channels. This eliminates the need to change channels by entering the channel digits. There are three steps for memorizing channels: selecting a broadcast source, memorizing the channels (automatic) and adding and deleting channels (manual).

Selecting the Video Signal Source

Before your television can begin memorizing the available channels, you must specify the type of signal source that is connected to the TV (i.e., an antenna or a cable system).

1

Press the **MENU** button.

Press the **▲** or **▼** button to select “Channel”, then press the **ENTER** button

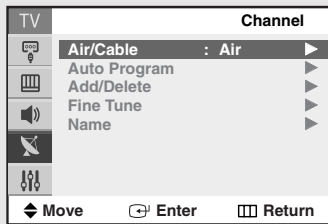

2

Press the **ENTER** button to select “Air/Cable”.

Press the **▲** or **▼** button to select “Air” or “Cable”, then press the **ENTER** button.

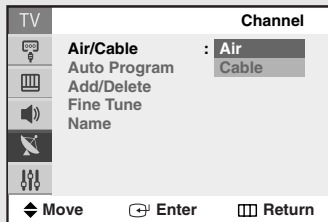

Storing Channels in Memory (Automatic Method)

3

Press the ▲ or ▼ button to select "Auto Program", then press the **ENTER** button.

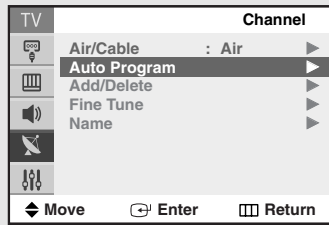

4

Press the **ENTER** button to start the auto program. The TV begins memorizing all available channels.

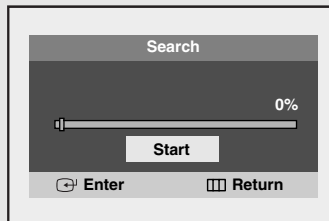

5

Press the **ENTER** button at any time to interrupt the memorization process.

Press the **EXIT** button to exit.

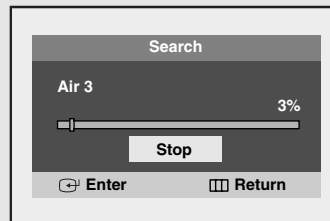

◀ The TV must be connected to an antenna in order to receive TV signals. Even if a particular channel is deleted from the memory, you can always tune to that channel directly by using the number buttons on the remote control.

- All available channels are automatically stored in memory when channels are selected by the direct tuning function.

Adding and Erasing Channels

To add channels that were not memorized (or to delete unwanted channels from memory):

1

Press the **MENU** button.

Press the **▲** or **▼** button to select "Channel", then press the **ENTER** button.

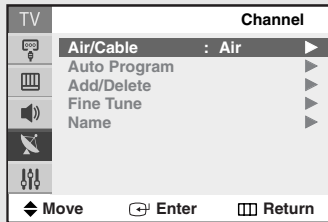

2

Press the **▲** or **▼** button to select "Add/Delete", then press the **ENTER** button.

Press the **▲** or **▼** button to select the desired channel, then press the **ENTER** button.

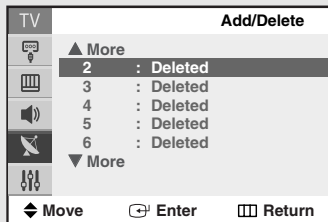

3

Press the **▲** or **▼** button to select "Added" or "Deleted", then press the **ENTER** button.

Press the **EXIT** button to exit.

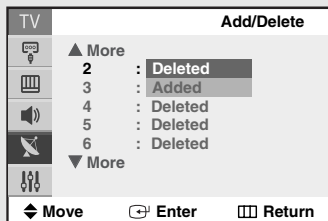

Changing Channels

Using the Channel Buttons

Press the **CH** \wedge or **CH** \vee button to change channels.

When you press **CH** \wedge or **CH** \vee , the TV changes channels in sequence. You will see all the channels that the TV has memorized. (The TV must have memorized at least three channels.) You will not see channels that were either erased or not memorized.

Using the Number Buttons

Use the number buttons to quickly tune to any channel.

Press the number buttons to go directly to a channel.
For example, to select channel 27, press “2” then “7”.
The TV will change channels when you press the second number.

When you use the number buttons, you can directly select channels that were either erased or not memorized.

To select a channel over 100, press the **+100** button. (For channel 122, press “+100” then “2” then “2”.)

To change to single-digit channels (0–9) faster, press “0” before the single digit. (For channel “4” press “0” then “4”.)

Using the PRE-CH Button to Select the Previous Channel

Press the **PRE-CH** button.
The TV changes to the last channel you were watching.

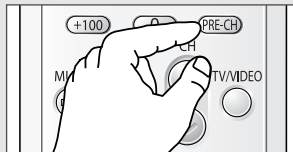

◀ To quickly switch between two channels that are far apart, tune to one channel, then use the number buttons to select the second channel. Then, use the **PRE-CH** button to quickly alternate between them.

Labelling the Channels

Use this feature to assign an easy-to-remember label to any channel (i.e., “CBS”, “ESPN”, “PBS2”, “CNN1”, etc.). A label consists of four fields, where each field is a letter, a number or a blank. When the **INFO** button is pressed, the channel label will appear next to the channel number.

1

Press the **MENU** button.

Press the **▲** or **▼** button to select “Channel”, then press the **ENTER** button.

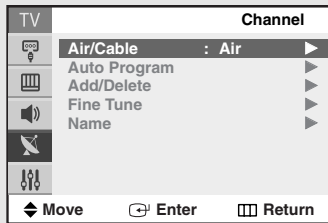

◀ You cannot select “Name” in the AV mode.

2

Press the **▲** or **▼** button to select “Name”, then press the **ENTER** button. Press the **▲** or **▼** button to select the channel to be assigned to a new name, then press the **ENTER** button.

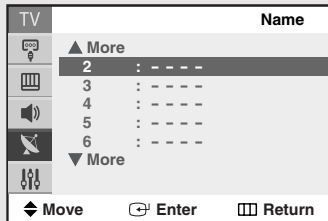

3

Press the **▲** or **▼** button to select a letter, a number or a blank. (Results in this sequence: A...Z, 0...9, blank, -).

Press the **▶** button to switch to the next field, which will be selected.

Select a second letter or digit by pressing the **▲** or **▼** button, as above.

Repeat the process to select the last two digits.

When you have finished, press the **ENTER** button.

Press the **EXIT** button to exit.

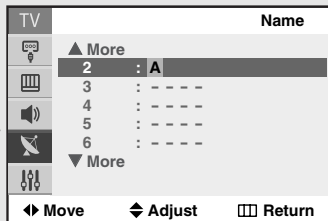

Picture Control

You can select the type of picture which best corresponds to your viewing requirements.

Using Automatic Picture Settings

Your TV has automatic picture settings (“Dynamic”, “Standard”, and “Movie”) that are preset at the factory. You can activate either Dynamic, Standard, or Movie by making a selection from the menu. Or, you can select “Custom” which automatically recalls your personalized picture settings.

1

Press the **MENU** button.

Press the **▲** or **▼** button to select “Picture”, then press the **ENTER** button.

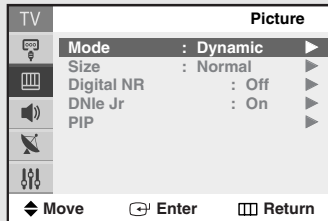

2

Press the **ENTER** button to select “Mode”.

Press the **ENTER** button again.

Press the **▲** or **▼** button to select a particular item, then press the **ENTER** button.

Press the **EXIT** button to exit.

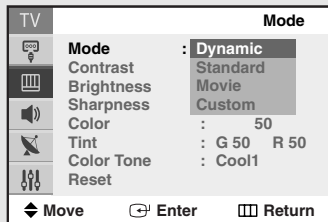

- Choose “Dynamic” for viewing the TV during the day or when there is bright light in the room.
- Choose “Standard” for the standard factory settings.
- Choose “Movie” when viewing a movie.
- Choose “Custom” if you want to adjust the settings according to personal preference.

Customizing the Picture

You can use the on-screen menus to change the “Contrast”, “Brightness”, “Sharpness”, “Color”, “Tint”, and “Color Tone” according to personal preference.

1

Press the **MENU** button.

Press the **▲** or **▼** button to select “Picture”, then press the **ENTER** button.

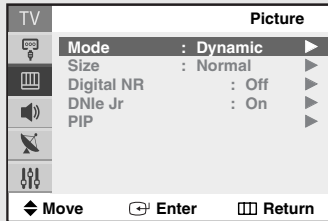

2

Press the **ENTER** button to select “Mode”.

Press the **ENTER** button again.

Press the **▲** or **▼** button to select a particular item (“Dynamic”, “Standard”, “Movie”, or “Custom”), then press the **ENTER** button.

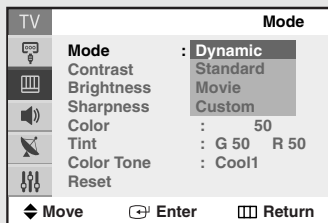

3

Press the **▲** or **▼** button to select a particular item (“Contrast”, “Brightness”, “Sharpness”, “Color”, or “Tint”), then press the **ENTER** button.

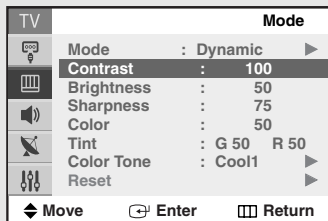

4

Press the **◀** or **▶** button to increase or decrease the value of a particular item.

Press the **▲** or **▼** button to select other items.

When you have finished, press the **ENTER** button.



continued...

5

Press the ▲ or ▼ button to select “Color Tone”, then press the **ENTER** button.

Press the ▲ or ▼ button to select a particular item (“Cool 2”, “Cool 1”, “Normal”, “Warm 1”, or “Warm 2”), then press the **ENTER** button.

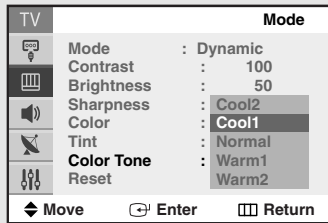

Resetting the Picture Settings to the Factory Defaults

6

Press the ▲ or ▼ button to select “Reset”, then press the **ENTER** button.

The reset function is set for each mode (“Dynamic”, “Standard”, “Movie”, or “Custom”).

The previously adjusted settings will be reset to the factory defaults.

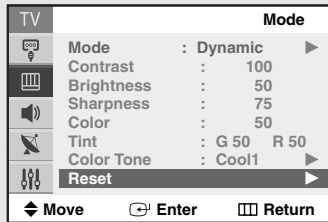

Sound Control

Adjusting the Volume

Press the **VOL +** or **VOL -** buttons to increase or decrease the volume.

Using the MUTE Button

At any time, you can temporarily cut off the sound using the **MUTE** button.

1

Press the **MUTE** button and the sound cuts off. The "⊘" is displayed.

To turn MUTE off, press the **MUTE** button again, or press either the **VOL +** or **VOL -** button.

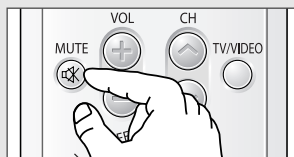

Using Automatic Sound Settings

Your TV has automatic sound settings (“Standard”, “Music”, “Movie”, and “Speech”) that are preset at the factory. You can activate either Standard, Music, Movie or Speech by making a selection from the menu. Or, you can select “Custom,” which automatically recalls your personalized sound settings.

1

Press the **MENU** button.

Press the **▲** or **▼** button to select “Sound”, then press the **ENTER** button.

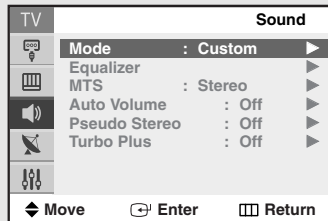

2

Press the **ENTER** button to select “Mode”.

Press the **▲** or **▼** button to select a particular item, then press the **ENTER** button.

Press the **EXIT** button to exit.

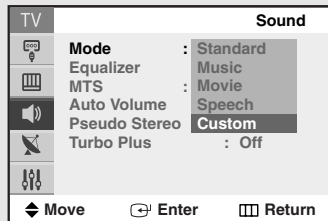

- Choose “Standard” for the standard factory settings.
- Choose “Music” when watching music videos or concerts.
- Choose “Movie” when watching movies.
- Choose “Speech” when watching a show that is mostly dialog (i.e., news).
- Choose “Custom” to recall your personalized settings.

Customizing the Sound

The sound settings can be adjusted to suit your personal preferences.
(Alternatively, you can use one of the automatic settings. See page 31.)

1

Press the **MENU** button.

Press the **▲** or **▼** button to select "Sound", then press the **ENTER** button.

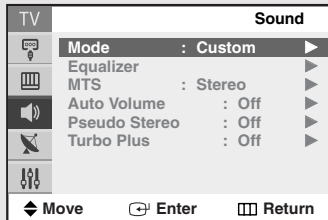

2

Press the **▲** or **▼** button to select "Equalizer", then press the **ENTER** button.

Press the **◀** or **▶** button to select the balance or a particular frequency to be adjusted.

Press the **▲** or **▼** button to increase or decrease the level of the required item.

Press the **EXIT** button to exit.

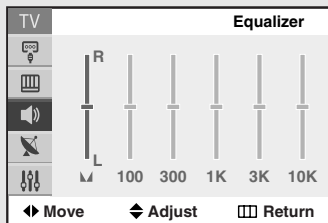

- If you make any changes to the equalizer settings, the sound mode is automatically switched to the "Custom" mode.
- "L/R" Sound Balance Adjustment
To adjust the sound balance of the L/R speakers.
- Bandwidth Adjustment (100, 300, 1K, 3K, 10K)
To adjust the level of different bandwidth frequencies.

Setting the Clock

Setting the clock is necessary in order to use the various timer features of the TV. Also, you can check the time while watching the TV. (Just press the **INFO** button.)

1

Press the **MENU** button.

Press the **▲** or **▼** button to select "Setup", then press the **ENTER** button.

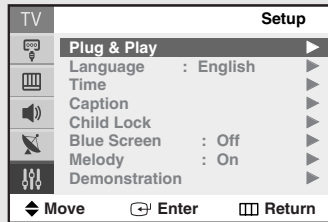

2

Press the **▲** or **▼** button to select "Time", then press the **ENTER** button.

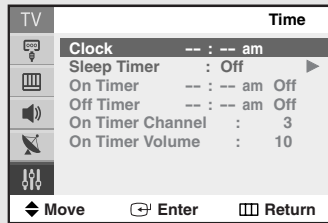

3

Press the **ENTER** button to select "Clock".

Press the **◀** or **▶** button to move to the hour or minute. Set the clock by pressing the **▲** or **▼** button.

Press the **EXIT** button to exit.

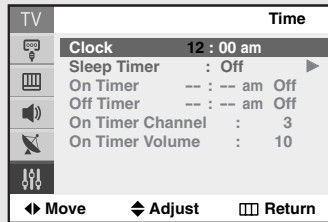

◀ The current time will appear every time you press the **INFO** button.

Viewing an External Signal Source

Use the remote control to switch between viewing signals from connected equipment, such as a VCR, DVD, set-top box, and the TV source (broadcast or cable).

Setting the Signal Source

1

Press the **MENU** button.

Press the **ENTER** button to select "Input".



2

Press the **ENTER** button to select "Source List".

Press the **▲** or **▼** button to select the desired signal source, then press the **ENTER** button.

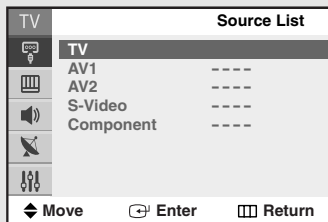

Alternate method:

Press the **TV/VIDEO** button on the remote control repeatedly to select the desired signal source

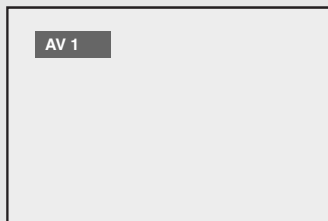

Assigning Names to External Input Mode

1

Press the **MENU** button.

Press the **ENTER** button to select "Input".

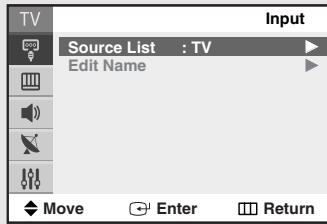

2

Press the **▲** or **▼** button to select "Edit Name", then press the **ENTER** button.



3

Press the **▲** or **▼** button to select the signal source to be edited, then press the **ENTER** button.

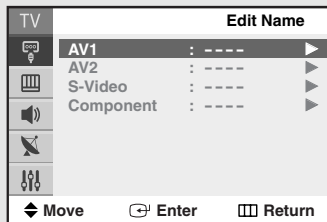

4

Press the **▲** or **▼** button to select the desired external device (VCR, DVD, Cable STB, Sat. STB, AV Receiver, DVD Receiver, Game, Camcorder, DVD Combo). Press the **ENTER** button.

Press the **EXIT** button to exit.

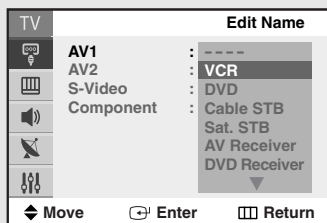

Chapter Four

SPECIAL FEATURES

Fine Tuning Channels

The Fine Tuning function lets you manually adjust the TV's tuner if you have difficulty tuning channels.

1

Press the **MENU** button.

Press the **▲** or **▼** button to select "Channel", then press the **ENTER** button.

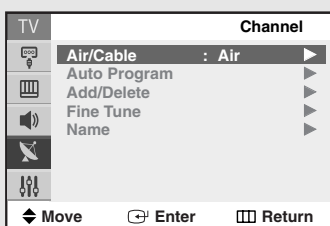

2

Press the **▲** or **▼** button to select "Fine Tune", then press the **ENTER** button.

Press the **◀** or **▶** button to adjust the fine tuning. To store the fine tuning setting in the TV's memory, press the **MENU** button.

To reset the fine tuning to "0", select "Reset" by pressing the **▲** or **▼** button, then press the **ENTER** button.

Press the **EXIT** button to exit.

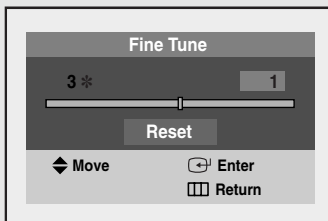
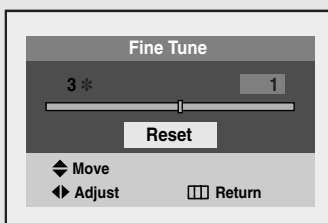
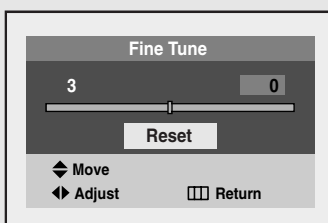

Changing the Screen Size

1

Press the **MENU** button.

Press the **▲** or **▼** button to select "Picture", then press the **ENTER** button.

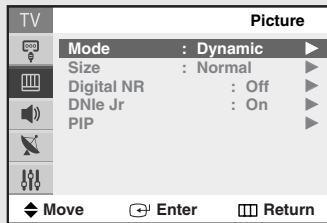

2

Press the **▲** or **▼** button to select "Size", then press the **ENTER** button.

Press the **▲** or **▼** button to select "Normal" or "Zoom", then press the **ENTER** button.

Press the **EXIT** button to exit.

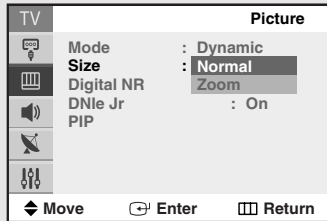

- Normal (4:3) :
Sets the picture to 4:3 normal mode.



- Zoom :
Magnifies the size of the picture.

Digital Noise Reduction

If the signal received by the television is weak, you can activate this feature to reduce any static and ghosting that may appear on the screen.

1

Press the **MENU** button.

Press the **▲** or **▼** button to select "Picture", then press the **ENTER** button.

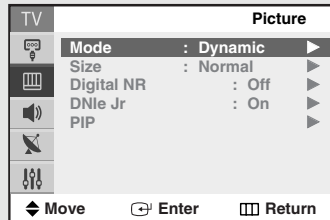

2

Press the **▲** or **▼** button to select "Digital NR", then press the **ENTER** button.

Press the **▲** or **▼** button to select "On" or "Off", then press the **ENTER** button.

Press the **EXIT** button to exit.

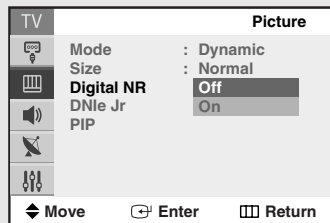

DNie Jr™ (Digital Natural Image engine) (depending on the model)

This feature brings you more detailed image with detail enhancement, contrast enhancement and white enhancement. New image compensation algorithm gives brighter, clearer, more detailed image to you. DNie Jr technology will fit every signal into your eyes.

1

Press the **MENU** button.

Press the **▲** or **▼** button to select "Picture", then press the **ENTER** button.

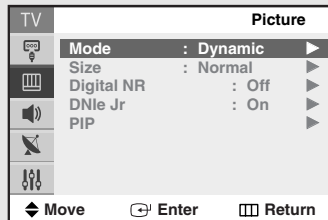

2

Press the **▲** or **▼** button to select "DNie Jr", then press the **ENTER** button.

Press the **◀** or **▶** button to select "On" or "Off", then press the **ENTER** button.

Press the **EXIT** button to exit.



Viewing Picture-In-Picture (depending on the model)

You can use the PIP feature to simultaneously watch two video sources.

Activating the PIP

1

Press the **MENU** button.

Press the **▲** or **▼** button to select "Picture", then press the **ENTER** button.

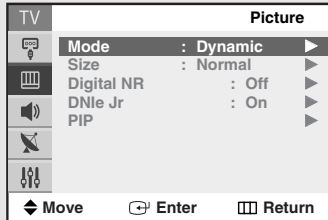

2

Press the **▲** or **▼** button to select "PIP", then press the **ENTER** button.

Press the **ENTER** button to select "PIP".

Press the **▲** or **▼** button to select "On", then press the **ENTER** button.

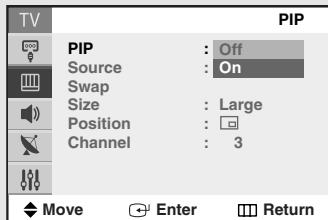

- ◀ If you turn TV off while watching and turn it on again, the PIP window will disappear.
- ◀ If the PIP is activated (On) when the picture size is set to "Zoom" mode, the picture size is automatically converted into "Normal" mode. However, you can select "Zoom" after activating the PIP.

Alternate method:

Press the **PIP** button on the remote control repeatedly to activate or deactivate the PIP.

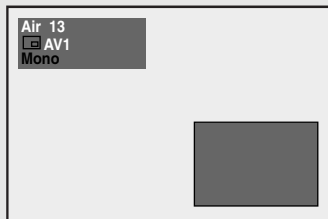
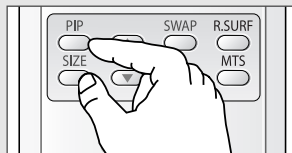

continued...

Selecting an External Source

3

Press the ▲ or ▼ button to select “Source”, then press the **ENTER** button.

Press the ▲ or ▼ button to select the desired signal source, then press the **ENTER** button.

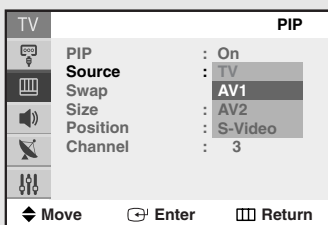

◀ For more information about external A/V components and signals, see “Viewing an External Signal Source” on page 34.

Swapping the Sub Picture and Main Picture

4

Press the ▲ or ▼ button to select “Swap”, then press the **ENTER** button. The sub picture is displayed in the main picture, and vice versa.

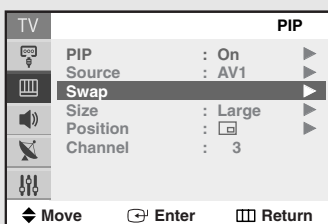

Alternate method:

Press the **SWAP** button on the remote control repeatedly to exchange the sub picture and the main picture.

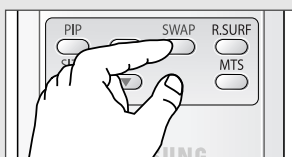

Changing the Size of the Sub Picture

5

Press the ▲ or ▼ button to select “Size”, then press the **ENTER** button.

Press the ▲ or ▼ button to select “Large” or “Small”, then press the **ENTER** button.

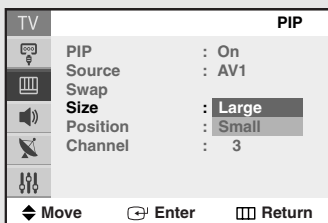

Alternate method:

Press the **SIZE** button on the remote control repeatedly to select the size for sub picture.

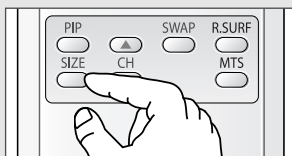

continued...

Changing the Position of the Sub Picture

6

Press the ▲ or ▼ button to select “Position”, then press the **ENTER** button.

Press the ▲ or ▼ button to select the desired position, then press the **ENTER** button.

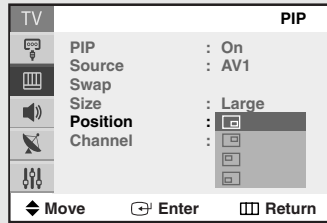

Changing the Channel of the Sub Picture

7

Press the ▲ or ▼ button to select “Channel”, then press the **ENTER** button.

Press the ◀ or ▶ button to select a channel of the sub picture, then press the **ENTER** button.

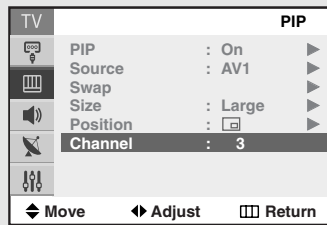

◀ You can select the “Channel” when the “Source” is set to “TV”.

Alternate method:

Press the **CH**▲ or ▼ button on the remote control repeatedly to select a channel of the sub picture

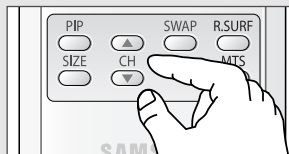

Using the R.Surf Feature

This feature allows you to set the TV to return to a particular channel after a certain amount of time. For example, you may be watching a channel when commercials start. You can set the R.Surf to “5 minutes”, then switch channels. After minutes, the TV will return to the original channel. To use the R.Surf feature:

1

While you are watching the channel to which you want to return, press the **R.SURF** button. The “Surf Off” is displayed.

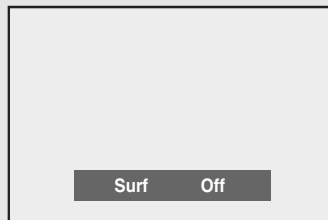
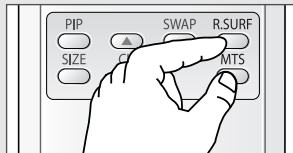

2

Press the **R.SURF** button again to set the timer in thirty second intervals, up to five minutes.

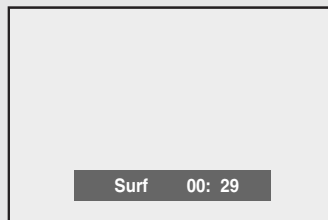

◀ The time will start decreasing while you are setting up the timer, and will reset after 5 minutes had passed or you turn it off.

3

The time you set will begin counting down on the screen. When the time runs out, the TV will return to the channel you were watching when you set the timer.

Choosing a Multi-Channel Sound (MTS) track

Depending on the particular program being broadcast, you can listen to Mono, Stereo, or SAP.

1

Press the **MENU** button.

Press the **▲** or **▼** button to select "Sound", then press the **ENTER** button.

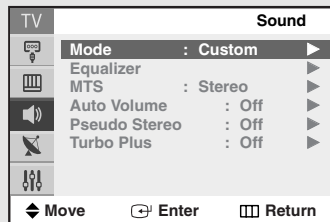

2

Press the **▲** or **▼** button to select "MTS", then press the **ENTER** button.

Press the **▲** or **▼** button to select one of the settings, then press the **ENTER** button.

Press the **EXIT** button to exit.

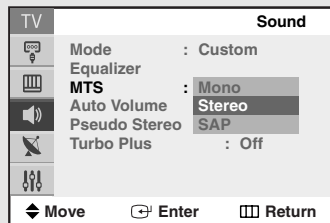

Alternate method:

Press the **MTS** button on the remote control repeatedly to select one of the settings.

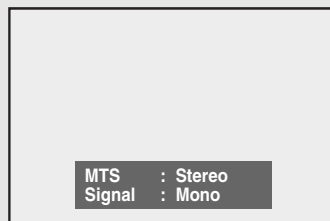
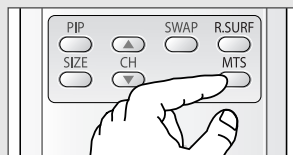

- Choose "Mono" for channels that are broadcasting in mono, or if you are having difficulty receiving a stereo signal.
- Choose "Stereo" for channels that are broadcasting in stereo.
- Choose "SAP" to listen to the Separate Audio Program, which is usually a foreign-language translation.

Extra Sound Settings (Auto Volume, Pseudo Stereo, or Turbo Plus)

The following sound settings can be adjusted to suit your personal preferences

- **Auto Volume**

Each broadcasting station has its own signal conditions, which can make it necessary to adjust the volume every time the channel is changed. “Auto Volume” lets you automatically adjust the volume of the desired channel by lowering the sound output when the modulation signal is high or by raising the sound output when the modulation signal is low.

- **Pseudo Stereo**

“Pseudo Stereo” converts a monaural sound signal into two identical left and right channels. Once the “Pseudo Stereo” is set to “On” or “Off”, the setting applies to the sound effects such as “Standard”, “Music”, “Movie” and “Speech”.

- **Turbo Plus**

“Turbo Plus” emphasizes the bass and treble frequencies to add fullness to the sound.

1
Press the **MENU** button.

Press the **▲** or **▼** button to select “Sound”, then press the **ENTER** button.

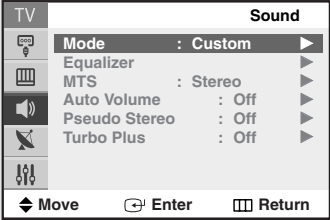

TV	Sound
Mode	: Custom
Equalizer	
MTS	: Stereo
Auto Volume	: Off
Pseudo Stereo	: Off
Turbo Plus	: Off

◆ Move Ⓜ Enter □ Return

2
Press the **▲** or **▼** button to select the required item (“Auto Volume”, “Pseudo Stereo”, or “Turbo Sound”), then press the **ENTER** button.

Press the **▲** or **▼** button to select “On” or “Off”, then press the **ENTER** button.

Press the **EXIT** button to exit.

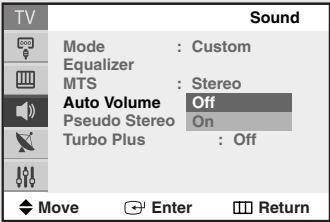

TV	Sound
Mode	: Custom
Equalizer	
MTS	: Stereo
Auto Volume	Off
Pseudo Stereo	On
Turbo Plus	: Off

◆ Move Ⓜ Enter □ Return

Setting the On/Off Timer

1

Press the **MENU** button.

Press the **▲** or **▼** button to select "Setup", then press the **ENTER** button.

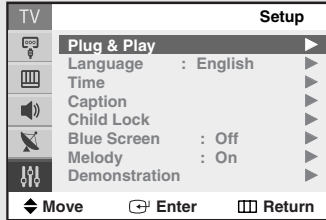

◀ You must set the clock first.

2

Press the **▲** or **▼** button to select "Time", then press the **ENTER** button.

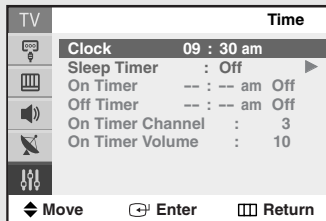

◀ The current time will appear every time you press the **INFO** button.

3

Press the **▲** or **▼** button to select "On Timer", then press the **ENTER** button.

Press the **◀** or **▶** button to move to the hour or minute. Set the clock by pressing the **▲** or **▼** button.

Press the **◀** or **▶** button to move to "Off". To activate the "On Timer", set to "On" by pressing the **▲** or **▼** button.

Press the **ENTER** button.

Set the "Off Timer" as methods for "On Timer" setting.

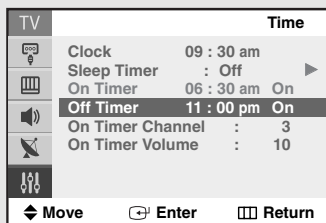
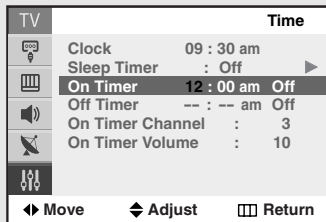

◀ **Auto Power Off**
When you set the timer "On", the television will eventually turn off, if no controls are operated for 3 hours after the TV was turned on by timer. This function is only available in timer "On" mode and prevents overheating or leakages, which may occur if a TV is on for too long (when you are away on holiday, for example).

continued...

Setting the Preferred Channel and Volume Level

The preferred channel and volume can be set for when the timer automatically turns on the TV.

4

Press the ▲ or ▼ button to select “On Timer Channel” or “On Timer Volume”.

Press the ◀ or ▶ button to select the desired channel or adjust volume level.

Press the EXIT button to exit.

TV	Time	
	Clock	09 : 30 am
	Sleep Timer	: Off ▶
	On Timer	06 : 30 am On
	Off Timer	11 : 00 pm On
	On Timer Channel	: 3
	On Timer Volume	: 10
	Move	
	Adjust	
	Return	

TV	Time	
	Clock	09 : 30 am
	Sleep Timer	: Off ▶
	On Timer	06 : 30 am On
	Off Timer	11 : 00 pm On
	On Timer Channel	: 3
	On Timer Volume	: 10
	Move	
	Adjust	
	Return	

Setting the Sleep Timer

The sleep timer automatically shuts off the TV after a preset time (from 30 to 180 minutes).

1

Press the **MENU** button.

Press the **▲** or **▼** button to select "Setup", then press the **ENTER** button.

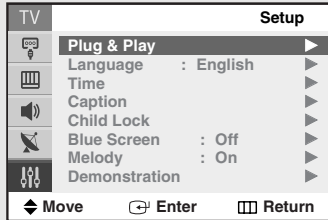

2

Press the **▲** or **▼** button to select "Time", then press the **ENTER** button.

Press the **▲** or **▼** button to select "Sleep Timer", then press the **ENTER** button.

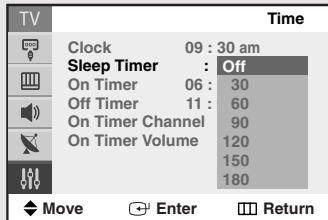

Press the **▲** or **▼** button to select the appropriate time interval, then press the **ENTER** button.

Press the **EXIT** button to exit.

Alternate method:

Press the **SLEEP** button on the remote control repeatedly until the appropriate time interval appears (any of the preset values from "30 Min." to "180 Min.").

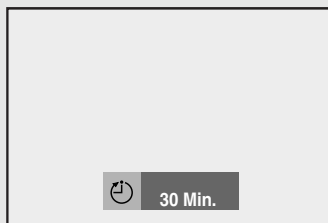

◀ After about 5 seconds, the sleep display will disappear from the screen, and the time interval will be set.

Viewing Closed Captions (On-Screen Text Message)

Your TV decodes and displays the closed captions that are broadcast with certain TV shows. These captions are usually subtitles for the hearing impaired or foreign-language translations. All VCRs record the closed caption signal from television programs, so home-recorded video tapes also provide closed captions. Most pre-recorded commercial video tapes provide closed captions as well. Check for the closed caption symbol in your television schedule and on the tape's packaging: .

1

Press the **MENU** button.

Press the **▲** or **▼** button to select "Setup", then press the **ENTER** button.

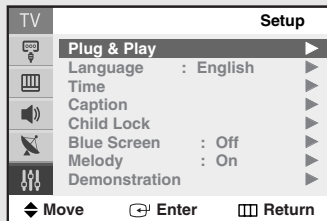

2

Press the **▲** or **▼** button to select "Caption", then press the **ENTER** button.

Press the **ENTER** button to select "Caption".

Press the **▲** or **▼** button to select "On", then press the **ENTER** button.

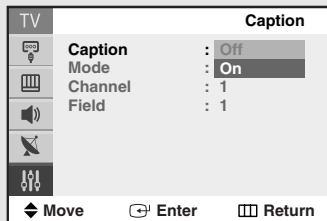

3

Press the **▲** or **▼** button to select "Mode", then press the **ENTER** button.

Press the **▲** or **▼** button to select "Caption" or "Text", then press the **ENTER** button.

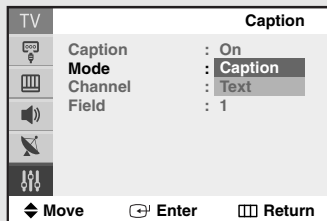

◀ Misspellings and unusual characters sometimes occur during closed caption transmissions, especially those of live events. There may be a small delay before captions appear when you change channels. These are not malfunctions of the TV.

◀ In "Caption" mode, captions appear at the bottom of the screen, and they usually cover only a small portion of the picture. In "Text" mode, information unrelated to the program, such as news or weather, is displayed. Text often covers a large portion of the screen.

continued...

4

Depending on the particular broadcast, it might be necessary to make changes to "Channel" and "Field".

Press the ▲ or ▼ button to select "Channel" or "Field", then press the **ENTER** button.

Press the ▲ or ▼ button to select "1" or "2", then press the **ENTER** button.

Press the **EXIT** button to exit.

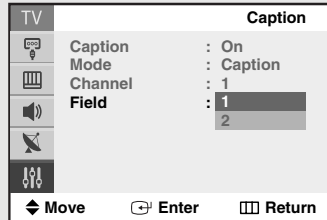
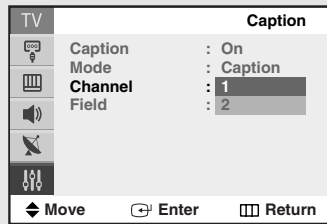

◀ Different channels and fields display different information: Field 2 carries additional information that supplements the information in Field 1. (For example, Channel 1 may have subtitles in English, while Channel 2 has subtitles in Spanish.)

Locking the Channel (depending on the model)

This feature allows you to prevent unauthorized users, such as children, from watching unsuitable programmes by muting out video and audio. Child Lock cannot be released using front (or side) panel buttons. Only remote control can release the Child Lock setting, so keep the remote control away from children.

1
Press the **MENU** button.

Press the **▲** or **▼** button to select "Setup", then press the **ENTER** button.

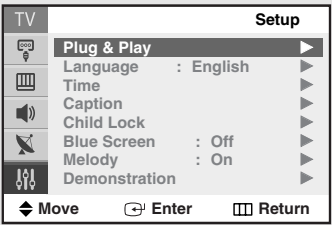

The screenshot shows the TV's Setup menu. The 'Plug & Play' option is highlighted. The menu items are: Plug & Play, Language : English, Time, Caption, Child Lock, Blue Screen : Off, Melody : On, and Demonstration. At the bottom, there are navigation buttons: Move, Enter, and Return.

2
Press the **▲** or **▼** button to select "Child Lock", then press the **ENTER** button.

Press the **ENTER** button to select "Child Lock".

Press the **▲** or **▼** button to select "On", then press the **ENTER** button.



The screenshot shows the TV's Child Lock menu. The 'Child Lock' option is highlighted and set to 'Off'. Other options are Channel Lock (Channel : 11, Lock : ?). At the bottom, there are navigation buttons: Move, Enter, and Return.

◀ If you want to unlock a channel, set to "Off".

3
Press the **▲** or **▼** button to select "Channel", then press the **ENTER** button.

Press the **◀** or **▶** button to select the channel to be locked.

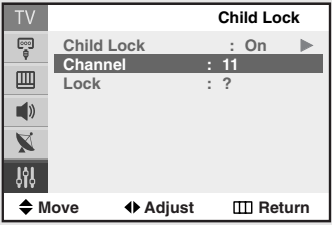

The screenshot shows the TV's Child Lock menu with 'Channel' highlighted and set to '11'. Other options are Child Lock (On) and Lock (?). At the bottom, there are navigation buttons: Move, Adjust, and Return.

4
Press the **▲** or **▼** button to select "Lock", then press the **ENTER** button. The "Locked" is displayed.

Press the **EXIT** button to exit.

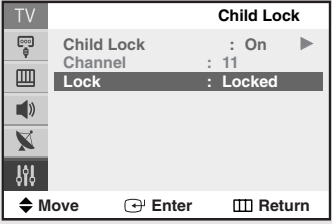

The screenshot shows the TV's Child Lock menu with 'Lock' highlighted and set to 'Locked'. Other options are Child Lock (On) and Channel (11). At the bottom, there are navigation buttons: Move, Enter, and Return.

◀ If any channel is locked, you can not access to the "Channel" and "Child Lock" menu by using the control buttons on the TV panel (the "Not Available" is displayed in the "Child Lock" menu). You can access by using the remote control only.

Setting the Blue Screen Mode

If no signal is being received or the signal is very weak, a blue screen automatically replaces the noisy picture background. If you wish to continue viewing the poor picture, you must set the “Blue Screen” mode to “Off”.

1

Press the **MENU** button.

Press the **▲** or **▼** button to select “Setup”, then press the **ENTER** button.

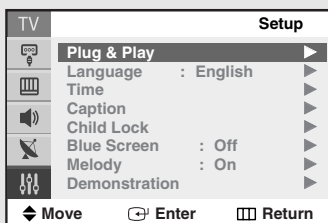

2

Press the **▲** or **▼** button to select “Blue Screen”, then press the **ENTER** button.

Press the **▲** or **▼** button to select “On” or “Off”, then press the **ENTER** button.

Press the **EXIT** button to exit.

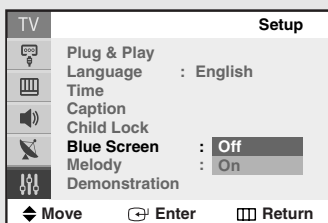

Setting the On/Off Melody

You can hear a melody sound when the TV is powered on or Off.

1

Press the **MENU** button.

Press the **▲** or **▼** button to select "Setup", then press the **ENTER** button.

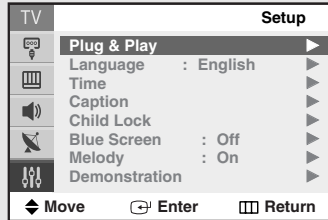

2

Press the **▲** or **▼** button to select "Melody", then press the **ENTER** button.

Press the **▲** or **▼** button to select "On" or "Off", then press the **ENTER** button.

Press the **EXIT** button to exit.

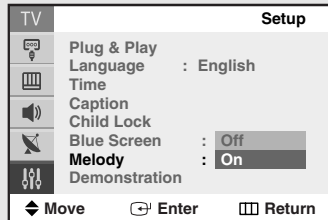

Viewing the Demonstration

To become familiar with the various menus provided by your television, you can view the in built demonstration.

1

Press the **MENU** button.

Press the **▲** or **▼** button to select "Setup", then press the **ENTER** button.

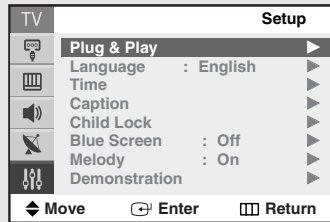

2

Press the **▲** or **▼** button to select "Demonstration", then press the **ENTER** button.

Each of the menu options is displayed in turn. When you wish to stop the demonstration, press any button on the remote control.

Press the **EXIT** button to exit.

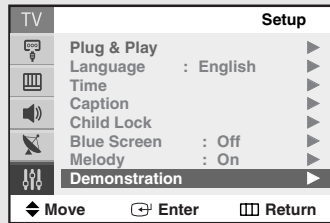

Chapter Five

TROUBLESHOOTING

If the TV seems to have a problem, first try this list of possible problems and solutions. If none of these troubleshooting tips apply, then call your nearest Samsung authorized service center.

Identifying Problems

Problem	Possible Solution
Poor picture.	Try another channel. Adjust the antenna. Check all wire connections.
Poor sound quality.	Try another channel. Adjust the antenna.
No picture or sound.	Try another channel. Press the TV/VIDEO button. Make sure the TV is plugged in. Check the antenna connections. Make sure the MUTE button is off.
No color, wrong colors or tints.	Make sure the program is broadcast in color. Adjust the picture settings.
Picture rolls vertically.	Adjust the antenna. Check all wire connections. If you are using a VCR, check the tracking.
The TV operates erratically.	Unplug the TV for 30 seconds, then try operating it again.
Your remote control does not operate your TV.	Make sure the remote has batteries. Check that the "+" and "-" ends of the batteries are inserted correctly. Check that the batteries are drained.
The TV won't turn on.	Make sure the wall outlet is working. Make sure the TV is plugged in. Make sure the remote has batteries.

Appendix

Cleaning and Maintaining Your TV

Please follow these guidelines to get the maximum performance from your TV.

Placement

- Do not place the TV near extremely hot, cold, humid or dusty places.
- Do not place the TV near appliances with electric motors that create magnetic fields, such as vacuum cleaners.
- Keep the ventilation openings clear; do not place the TV on a soft surface, such as cloth or paper.
- Place the TV in a vertical position only.

Liquids

- Do not handle liquids near or on the TV. Liquids that spill into it can cause serious damage.

Cabinet

- Never open the cabinet or touch the parts inside.
- Wipe your TV with a clean, dry cloth. Never use water, cleaning fluids, wax, or chemicals.
- Do not put heavy objects on top of the cabinet.

Temperature

- If your TV is suddenly moved from a cold to a warm place, unplug the power cord, and allow at least two hours for moisture that may have formed inside the unit to dry completely.

Using Your TV in Another Country

If you plan to take your TV with you to a foreign country, please be aware of the different television systems that are in use around the world. A TV designed for one system may not work properly with another system due to differences in the TV channel frequencies.

Specifications

Model	CL21M21 CL21M2	CL21M6	CL21T21
Voltage	AC100-240V AC120V (Mexico)	AC100-240V	AC100-240V AC120V (Mexico)
Frequency of Operation	50/60 Hz	50/60 Hz	50/60 Hz
Power Consumption	105 Watts	105 Watts	105 Watts
Dimensions (mm/inches)	605 X 490 X 463/ 23.82 X 19.29 X 18.23	582 X 481 X 456/ 22.91 X 18.94 X 17.95	694 X 783 X 506/ 27.32 X 30.83 X 19.92
Weight (Kg/lbs)	28.0/61.73	29.0/63.93	29.0/63.93

MEMO

MEMO

MEMO

