

SAMSUNG

**TX-R2675WH
TX-R2678WH
TX-R3075WH**

DIGITAL TELEVISION

SAMSUNG

ELECTRONICS

1-800-SAMSUNG (1-800-726-7864)

**Samsung Electronics America
Service Division**

400 Valley Road, Suite 201
Mount Arlington, NJ 07856
www.samsung.com

**Samsung Electronics Canada Inc.
Samsung Customer Care**

7037 Financial Drive
Mississauga, Ontario
L5N 6R3
www.samsung.ca

**Owner's
Instructions**

Important Warranty Information Regarding Television Format Viewing

Standard screen format televisions (4:3, the aspect ratio of the screen width to height) are primarily designed to view standard format full-motion video. The images displayed on them should primarily be in the standard 4:3 ratio format and constantly moving. Displaying stationary graphics and images on screen, such as the dark top and bottom letterbox bars (wide screen pictures), should be limited to no more than 15% of the total television viewing per week.

Wide screen format televisions (16:9, the aspect ratio of the screen width to height) are primarily designed to view wide screen format full-motion video. The images displayed on them should primarily be in the wide screen 16:9 ratio format, or expanded to fill the screen if your model offers this feature, and constantly moving. Displaying stationary graphics and images on screen, such as the dark side-bars on non-expanded standard format television video and programming, should be limited to no more than 15% of the total television viewing per week.

Additionally, viewing other stationary images and text such as stock market reports, video game displays, station logos, web sites or computer graphics and patterns, should be limited as described above for all televisions. *Displaying any stationary images that exceed the above guidelines can cause uneven aging of picture tubes (CRTs) that leave subtle, but permanent burned-in ghost images in the television picture. To avoid this, vary the programming and images, and primarily display full screen moving images, not stationary patterns or dark bars.* On television models that offer picture sizing features, use these controls to view the different formats as a full screen picture.

Be careful in the selection and duration of television formats used for viewing. Uneven CRT aging as a result of format selection and use, as well as other burned-in images, is not covered by your Samsung limited warranty.

A Guide to Digital TV

What is Digital Television?

Digital television (DTV) is a new way of transmitting high quality video and audio to your TV set. Using DTV, broadcasters can transmit high definition TV (HDTV) images, Dolby digital surround audio, and new services such as multicasting (transmitting more than one program on the same TV channel) and datacasting (providing electronic program guides and interactive television).

Several of these services can be combined into a single digital broadcast.

Digital Television Services

Digital Picture Quality

DTV programs are transmitted in two different formats. The first is Standard Definition Television (SDTV) and the second is High Definition Television (HDTV).

SDTV program formats include 480-line interlaced (480i) and 480-line progressive (480p) video. 480i programs are essentially a digital version of our current analog TV programs, while the 480p format offers improved image detail over 480i. Some 480p programs are broadcast in widescreen and are comparable to progressive-scan DVD movies in image quality.

HDTV program formats include 1080-line interlaced (1080i) and 720-line progressive (720p). Both HDTV formats are always broadcast in widescreen, and offer much higher picture quality than SDTV.

Dolby Surround Sound

With DTV, you can listen to a variety of Dolby digital audio formats from Dolby Surround 2.0 to Dolby Digital 5.1 surround, using your home audio system. Many HDTV programs are now broadcast with DD 5.1 soundtracks.

Interactive Communications and Datacasting

DTV will allow you to interact with your television; choosing programs from a detailed program guide, ordering products on-line while watching TV, and accessing ancillary data about a program.

How to View Digital Television

There are three ways to watch DTV. The first is to use an integrated digital TV; one with a built-in digital television tuner. The second is to connect an external DTV set-top receiver to a DTV-ready television or monitor. This type of TV or monitor will have wideband component video and stereo audio inputs. You can also watch DTV signals with personal computer (PC) tuner cards and computer monitors.

1. Integrated TVs versus DTV-ready TVs and monitors

The advantage of an integrated DTV set is that it can tune both analog and digital TV channels at the same time. All you need to do is adding an external antenna and you are ready to watch DTV.

However, integrated DTV sets are not as common as DTV-ready TVs and monitors. If you already own a DTV-ready TV with component video inputs, you can enjoy DTV broadcasts by simply adding a low-cost DTV set-top receiver and antenna.

2. Using a personal computer and monitor

There are plug-in cards available that will receive and display DTV broadcasts on your computer monitor. In addition, many computer monitors will display one or more of the DTV program formats directly. The most compatible format is 480p, which is similar to the VGA (640x480 pixel) computer display standard. You may be able to watch DTV broadcasts by connecting a computer monitor to the 15-pin jack on the rear of the set-top DTV receiver.

NOTE

This television receiver supports the copy protection system regulated by DTLA (Digital Transmission Licensing Administrator). It should be noted that copy protected content may not be viewable depending on your particular connections.

Q&A

1. Is the antenna I use for existing TV reception good enough for DTV?

Over-the-air (OTA) digital TV broadcasting uses the same channels as analog TV and works well with many existing TV antennas. However, DTV broadcast channel assignments are different than analog channels. You should find out whether your local DTV broadcasts are on VHF (channels 2-13) or UHF (channels 14-69) to see if you need a different antenna.

If your DTV channels are on UHF and you already get good UHF reception, your present antenna may work fine. The same holds true for VHF DTV reception. Note that in some markets, both VHF and UHF channels are used for DTV broadcasts.

You can find out the latest DTV channel assignments for your area by browsing selected Internet web sites such as www.titantv.com , www.10000watts.com, and www.fcc.gov.

2. How difficult is it to receive DTV signals indoors?

This depends on whether your local DTV stations are running full power or not and how close your location is to the transmission tower. DTV receivers do not require as much signal as analog TV receivers to produce high-quality images and sound.

Once the DTV signal level exceeds a certain threshold at the receiver, the digital video and audio data is decoded at the same quality it was originally encoded for broadcast. This is a big advantage for DTV over analog TV - there is no noise, ghosting, static, or scratchy audio.

3. How can I connect an antenna in my townhouse, co-operative apartment, condominium, or apartment?

The Federal Communications Commission's OTARD Rule (part of the Telecommunications Act of 1996) allows residents of condominiums, townhouse, or members of neighborhood associations to put up outside antennas for reception of broadcast TV signals as long as those antennas are not located in common areas and are no more than 12" in height.

Residents of rental units (apartments, etc) are not covered by the OTARD rules and will have to use indoor antennas to receive DTV broadcasts. It is possible that the landlord of an apartment complex can provide broadcast DTV signals via a master TV antenna system to each apartment.

4. Can I connect my DTV set-top receiver to my cable TV service?

Cable TV systems use a different method for transmitting digital TV programs that is currently incompatible with broadcast DTV set-top receivers. So you will still need to use an outdoor or indoor antenna to receive OTA broadcast DTV programs.

The good news is that you won't have to pay a monthly or per-program charge to watch OTA DTV and HDTV programs. They're free, unlike subscription satellite TV or premium cable TV. All you need is an antenna and a DTV set-top receiver to enjoy clear, sharp widescreen images and high-quality audio.

Chapter 1: Your New Digital TV 8

List of Features	8
Accessories	8
Familiarizing Yourself with Your New TV	9
Control Buttons	9
Connection Jacks (Side)	10
Connection Jacks (Rear)	11
Remote Control	12

Chapter 2: Installation 14

Connecting VHF and UHF Antennas	14
Antennas with 300-ohm Flat Twin Leads	14
Antennas with 75-ohm Round Leads	15
Separate VHF and UHF Antennas	15
Connecting Cable TV	15
Cable without a Cable Box	15
Cable with a Cable Box that Descrambles All Channels	16
Connecting to a Cable Box that Descrambles some Channels	16
Connecting a VCR	18
Connecting an S-VHS VCR	19
Connecting a Second VCR to Record from the TV	19
Connecting a DVD Player	20
Connecting to Y, P _B , P _R	20
Connecting to Regular Audio and Video Jacks	20
Connecting a Digital TV Set-Top Box(480p/720p/1080i)	21
Connecting to Y, P _B , P _R	21
Connecting to HDMI(High Definition Multimedia Interface)	22
Connecting a Camcorder	23
Connecting to a Digital Audio System	24
Connecting to an External Amplifier (Variable Audio Output)	24
Installing Batteries in the Remote Control	25

Chapter 3: Operation 26

Turning the TV On and Off	26
Plug & Play Feature	26
Viewing the Menus and On-Screen Displays	28
Viewing the Menus	28
Viewing the Display	28
Selecting a Menu Language	29
Selecting the Antenna Input	30
Memorizing the Channels	31
Selecting the Video Signal-source	31
Storing Channels in Memory	32
Adding and Erasing Channels	33
Changing Channels	34
Using the Channel Buttons	34
Using the Number Buttons	34
Using the Previous Channel	34
Selecting Your Favorite Channels	35
To Store Your Favorite Channels	35
To View Your Favorite Channels	35
Labeling the Channels	36
Picture Control	37
Using Automatic Picture Settings	37
Customizing the Picture	38
Resetting the Picture Settings to the Factory Defaults	39

Chapter 3: Operation (Cont.)40

Sound Control	40
Adjusting the Volume	40
Using Mute	40
Customizing the Sound	40
Using Automatic Sound Settings	41
Setting the Clock	42
Option 1: Setting the Clock Manually	42
Option 2: Setting the Clock Automatically	44
Viewing an External Signal Source	46
Setting the Signal Source	46
Assigning Names to External Input Mode	47

Chapter 4: Special Features48

Fine Tuning Analog Channels	48
Checking the Digital-Signal Strength	49
Changing the Screen Size	50
Tilt	51
Using the R.Surf Feature	52
Extra sound settings (Auto Volume, BBE)	53
Auto Volume	53
BBE	54
Choosing a Multi-Channel Sound (MTS) track	55
When a Digital Signal is received	55
When an Analog Signal is received	56
Choosing a Digital Sound Format	57
Setting the On/Off Timer	58
Setting the Sleep Timer	59
Using the V-Chip (USA)	60
How to Change Your Password	60
How to Set up Restrictions Using the “TV Parental Guidelines”	61
How to Set up Restrictions using the Movie Ratings: G, PG, PG-13, R, NC-17, X	62
Important Notes About Parental Locks	63
Viewing Closed Captions	64
Setting Up Analog Captions (On-Screen Text Messages)	64
Setting Up Digital Captions (On-Screen Text Messages)	65
Menu Transparency Level	67
Setting the Function Help	68
Electronic Program Guide	69
Using the Electronic Program Guide	70
Viewing Information about a Single Channel	72
Viewing Information about Channels	73
Reminder List	74
Reminded Viewing List	74
To view the Reminder List	75
Customizing Your Remote Control	76

Chapter 5: Troubleshooting78

Identifying Problems	78
--------------------------------	----

Appendix79

Cleaning and Maintaining Your TV	79
Using Your TV in Another Country	79
Specifications	79

Manufactured under license from Dolby Laboratories.
“Dolby” and the double D-symbol are trademarks of Dolby Laboratories.

Chapter One

YOUR NEW DIGITAL TV

List of Features

Your Samsung TV is designed with the latest technology. This TV is a high-performance unit that includes the following special features:

- Easy-to-use remote control
- Easy-to-use on-screen menu system
- Automatic timer to turn the TV on and off
- Adjustable picture and sound settings that can be stored in the TV's memory
- A special filter to reduce or eliminate reception problems
- Fine tuning control for the sharpest picture possible
- A built-in multi-channel sound decoder for stereo and bilingual listening
- Built-in, dual channel speakers
- A special sleep timer
- 16:9 letter box format available depending upon source
- Component Video Input jacks to obtain a sharper image from external sources
- DIGITAL INPUT(High Definition Multimedia Interface)jack
- OPTICAL OUTPUT
- Samsung's New Technology enables an improved image with detail, contrast and white enhancement and 3D noise reduction.

Accessories

Once you have unpacked your TV, check to make sure that you have all the parts shown here. If any piece is missing or broken, call your dealer.

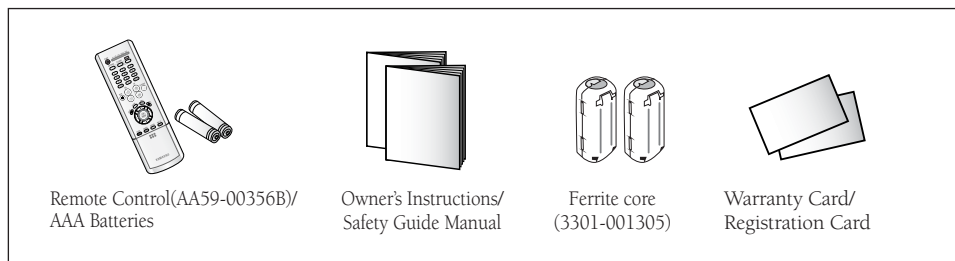

Familiarizing Yourself with Your New TV

Control Buttons

You can control your TV's basic features, including the on-screen menu. To use the more advanced features, you must use the remote control.

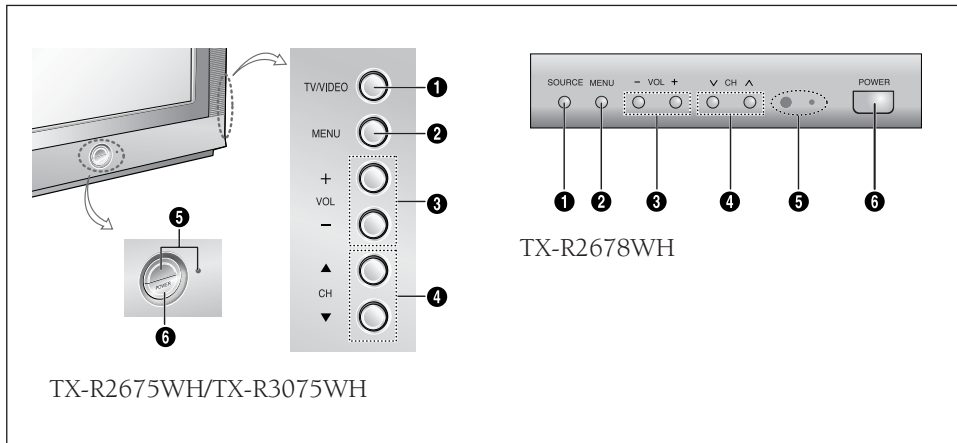

1 TV/VIDEO (TX-R2675WH/TX-R3075WH) & SOURCE (TX-R2678WH) & ENTER

Press to change between viewing TV programs and signals from other components. While using the on-screen menus, press ENTER to activate (or change) a particular item.

2 MENU

Press to see an on-screen menu of your TV's features.

3 - VOL +

Press to increase or decrease the volume. Also used to select items on the on-screen menu.

4 ▲ CH ▼ (TX-R2675WH/TX-R3075WH) & ∨ CH ^ (TX-R2678WH)

Press to change channels. Also, press to highlight various items on the on-screen menu.

5 Remote Control Sensor & STANDBY indicator

Aim the remote control towards this spot on the TV. Lights up when you turn the power off.

6 POWER

Press to turn the TV on and off.

Connection Jacks (Side)

You can connect an A/V component that is used only occasionally, such as a camcorder or video game. (For information on connecting equipment, see page 23.)

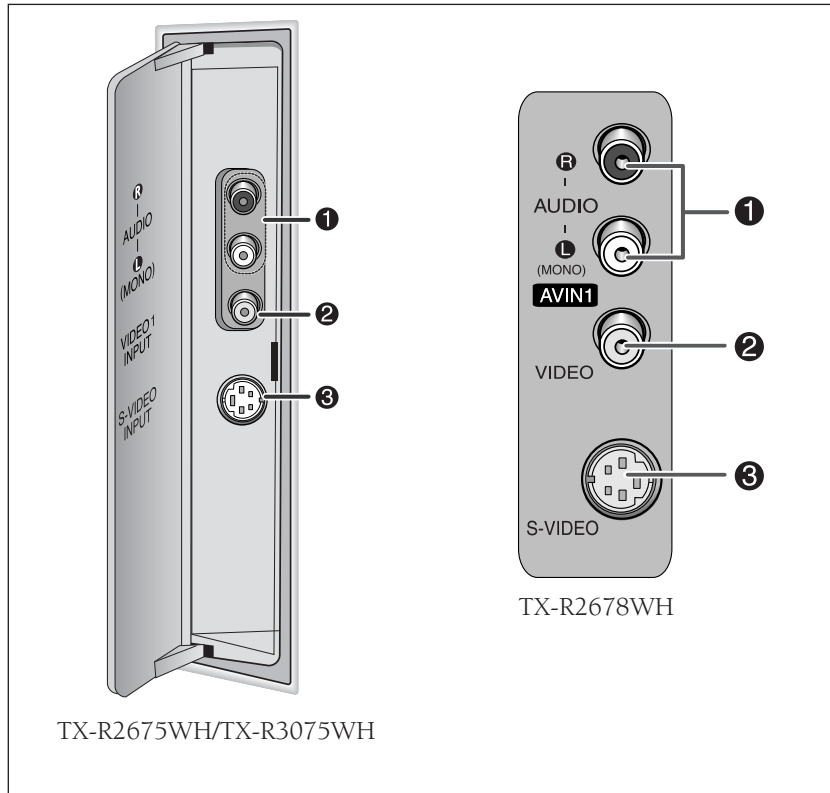

- 1 AUDIO Input**
Connect audio signals from a camcorder or video game.
- 2 VIDEO1 Input**
Connect a video signal from a camcorder or video game.
- 3 S-VIDEO Input**
Connect an S-Video signal from a camcorder or video game.

Connection Jacks (Rear)

Use the rear panel jacks to connect an A/V component that will be connected continuously, such as a VCR or a DVD player.

For more information on connecting equipment, see page 14~24.

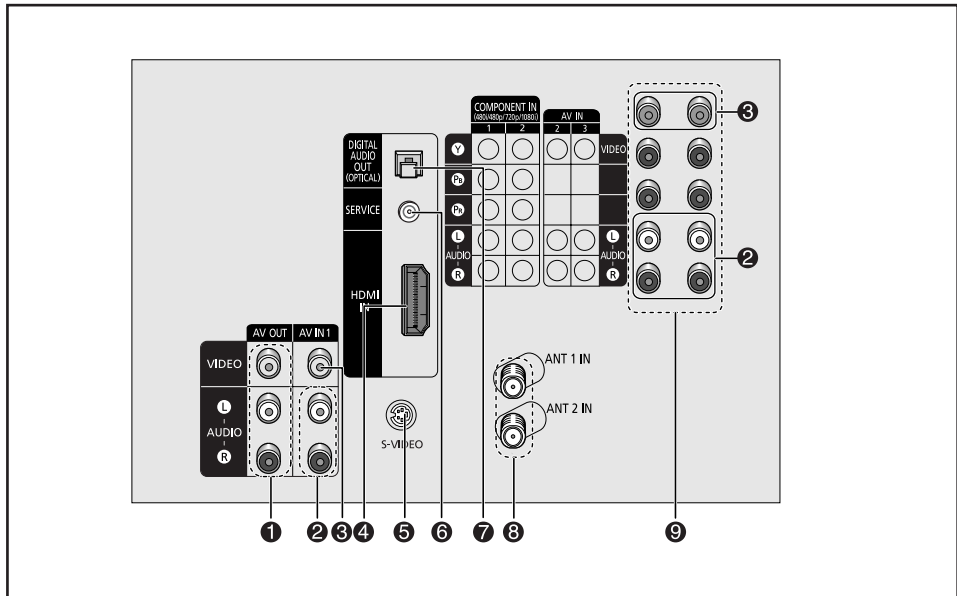

1 Audio-Video Output jacks

Connect to the audio/video input jacks of a recording VCR.

2 AUDIO Input jacks

Connect to the audio output jacks of VCRs, DVD players and similar devices.

3 VIDEO Input jacks

Connect to the video output jacks of VCRs, DVD players and similar devices.

4 HDMI Video Input jack

(High Definition Multimedia Interface)
Connect to the HDMI jack for device with HDMI output.

5 S-Video Input jack

Connect to S-Video output jack of an S-VHS VCR or DVD player.

6 SERVICE

For service only.

7 DIGITAL AUDIO OUT (OPTICAL)

Connect to a Digital Audio component.

8 ANTENNA terminals

Two independent cables or antennas can be connected to these terminals. Use ANT1IN and ANT2IN terminals to receive a signal from VHF/UHF antennas or your cable system.

9 Component Input jacks (Y, PB, PR, AUDIO-L/R)

Connect to the Component audio and video outputs of DVD or DTV set-top box. 480i/480p/720p/1080i Y, PB and PR video signal inputs are available./

YOUR NEW DIGITAL TV

Remote Control

You can use the remote control up to about 23 feet from the TV. When using the remote, always point it directly at the TV.

You can also use your remote control to operate your VCR, DVD, and Cable Box, and Samsung set-top box. See pages 76~77 for details.

- 1 POWER**
Turns the TV on and off.
- 2 ANTENNA**
Press to select ANT 1IN or ANT 2IN.
- 3 TV/COMP.**
Press to switch the TV, COMPONENT1, 2 or HDMI mode.
- 4 Number buttons**
Press to select channels directly on the TV.
- 5 +100**
Press to select channels over 100. For example, to select channel 121, press "+100", then press "2" and "1".
- 6 VOL +, VOL -**
Press to increase or decrease the volume.
- 7 MUTE**
Press to temporarily cut off the sound.
- 8 GUIDE**
Press to display the on-screen Electronic Program Guide (EPG).
- 9 MENU**
Displays the main on-screen menu.
- 10 ▲/▼/◀/▶**
Controls the cursor in the menu.
- 11 P.SIZE**
Press to change the screen size.
- 12 P.MODE**
Adjust the TV picture by selecting one of the preset factory settings (or select your personal, customized picture settings).

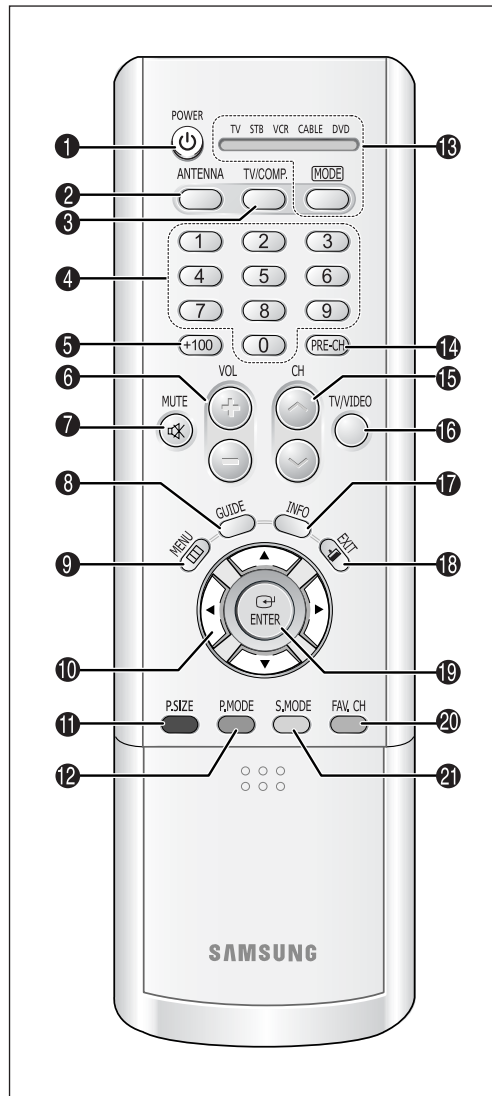

- 13 MODE**
Selects a target device to be controlled by this remote control (i.e., TV, Samsung STB, VCR, Cable box, or DVD).
- 14 PRE-CH**
Tunes to the previous channel.
- 15 CH ^, CH v**
Press to change channels.
- 16 TV/VIDEO**
Press to display all of the available video sources.
- 17 INFO**
Press to display information on the TV screen.
- 18 EXIT**
Press to exit the menu.
- 19 ENTER**
While using the on-screen menus, press ENTER to activate (or change) a particular item.
- 20 FAV. CH (Favorite Channel)**
Press to switch between your favorite channels.
- 21 S.MODE**
Adjust the TV sound by selecting one of the preset factory settings (or select your personal, customized sound settings).

Remote Control (continued)

- 22 ADD/DEL**
Press to add or erase channels in the TV's memory.
- 23 AUTO.PROG**
Press to display the memorized channels menu.
- 24 BBE**
BBE is a built-in effect that adds clarity, punch and dynamics to the sound.
- 25 CAPTION**
Controls the caption decoder.
- 26 VCR controls**
Controls VCR/DVD functions: Rewind, Stop, Play/Pause, Fast Forward.
- 27 SET**
Used during set up of this remote control, so that it will work compatibly with other devices (VCR, Samsung set-top box, Cable box, DVD, etc.)

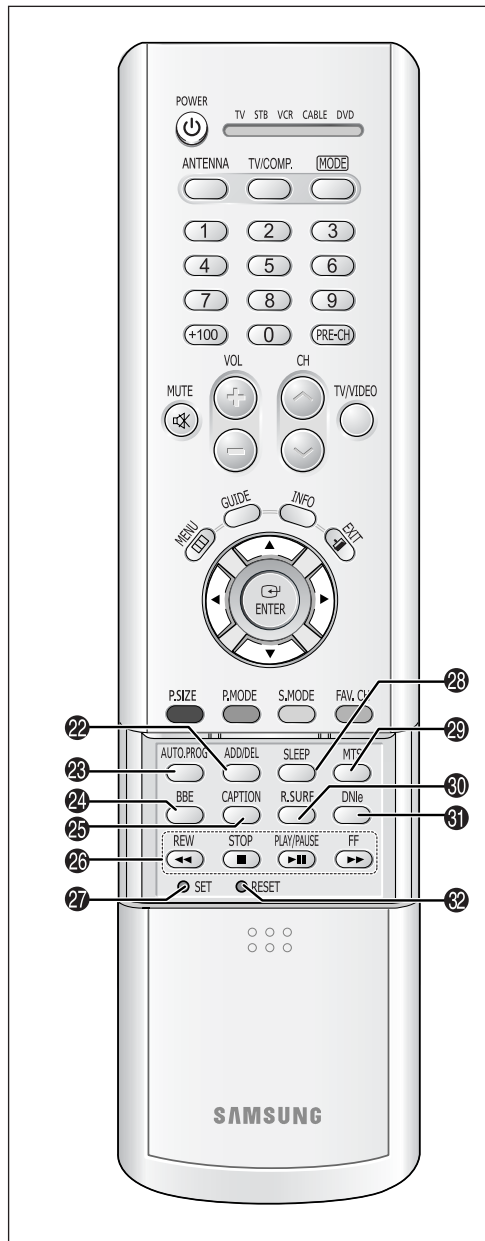

- 28 SLEEP**
Press to select a preset time interval for automatic shutoff.
- 29 MTS (Multi-channel Television Sound)**
Press to choose "Stereo", "Mono", or "SAP" (Secondary Audio Program).
- 30 R.SURF**
Press to automatically return to a preferred channel after a user-preset time delay.
- 31 DNLe**
Not available.
- 32 RESET**
If your remote control is not functioning properly, take out the batteries and press the reset button for about 2~3 seconds. Re-insert the batteries and try using the remote control again.

Chapter Two

INSTALLATION

Connecting VHF and UHF Antennas

If your antenna has a set of leads that look like this, see “Antennas with 300-ohm Flat Twin Leads,” below.

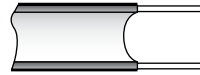

If your antenna has one lead that looks like this, see “Antennas with 75-ohm Round Leads,” on page 15.

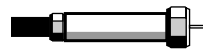

If you have two antennas, see “Separate VHF and UHF Antennas,” on page 15.

Antennas with 300-ohm Flat Twin Leads

If you are using an off-air antenna (such as a roof antenna or “rabbit ears”) that has 300-ohm twin flat leads, follow the directions below.

1

Place the wires from the twin leads under the screws on the 300-75 ohm adaptor (not supplied). Use a screwdriver to tighten the screws.

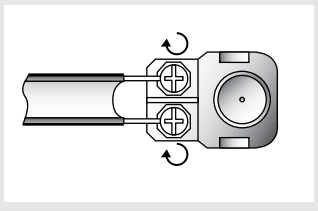

2

Plug the adaptor into the ANT 1 IN or ANT 2 IN terminal on the rear panel.

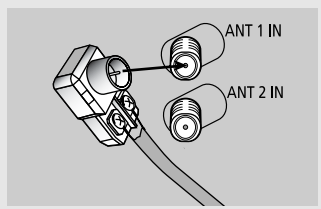

Antennas with 75-ohm Round Leads

Plug the antenna lead into the ANT 1 IN or ANT 2 IN terminal on the rear panel.

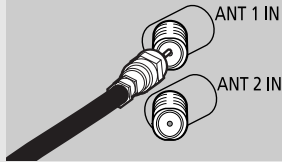

Separate VHF and UHF Antennas

If you have two separate antennas for your TV (one VHF and one UHF), you must combine the two antenna signals before connecting the antennas to the TV. This procedure requires an optional combiner-adaptor (available at most electronics shops).

1

Connect both antenna leads to the combiner.

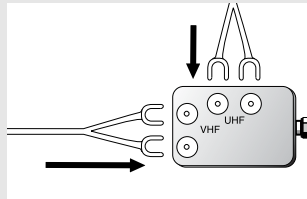

2

Plug the combiner into the ANT 1 IN or ANT 2 IN terminal on the rear panel.

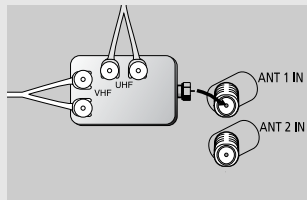

Connecting Cable TV

You can connect different cable systems to your TV, including cable without a cable box, and cable with a cable box that descrambles some or all channels.

Cable without a Cable Box

If you want to connect cable, and you do not need to use a cable box:

Plug the incoming cable into the ANT 1 IN or ANT 2 IN terminal on the rear panel.

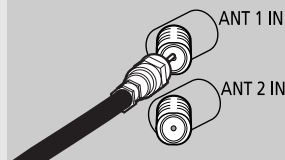

Cable with a Cable box that Descrambles All Channels

1

Find the cable that is connected to the ANTENNA OUT terminal on your cable box. This terminal might be labeled "ANT OUT", "VHF OUT", or simply, "OUT".

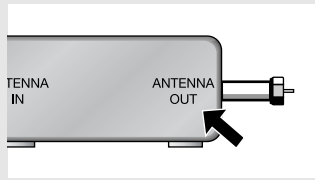

2

Connect the other end of this cable to the ANT 1 IN or ANT 2 IN terminal on the rear panel.

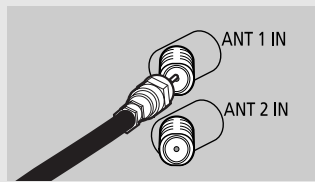

Connecting to a Cable Box that Descrambles Some Channels

If your cable box descrambles only some channels (such as premium channels), follow the instructions below. You will need a two-way splitter, an RF (A/B) switch, and four lengths of coaxial cable. (These items are available at most electronics stores.)

1

Find and disconnect the cable that is connected to the ANTENNA IN terminal on your cable box.

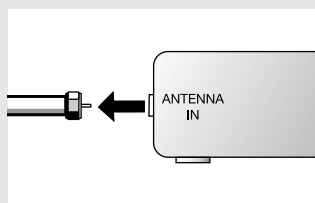

◀ This terminal might be labeled "ANT IN," "VHF IN," or simply, "IN."

2

Connect this cable to a two-way splitter.

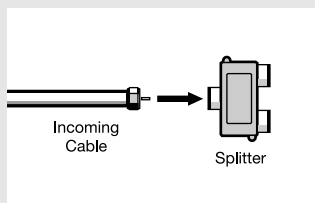

3

Connect a coaxial cable between an OUTPUT terminal on the splitter and the IN terminal on the cable box.

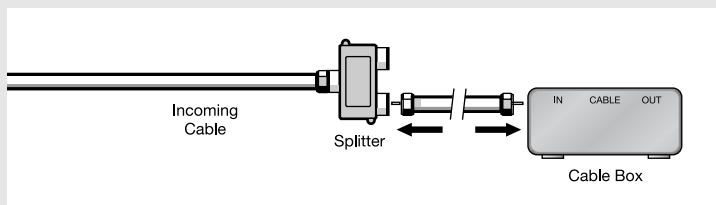

INSTALLATION

4

Connect a coaxial cable between the ANTENNA OUT terminal on the cable box and the B-IN terminal on the RF (A/B) switch.

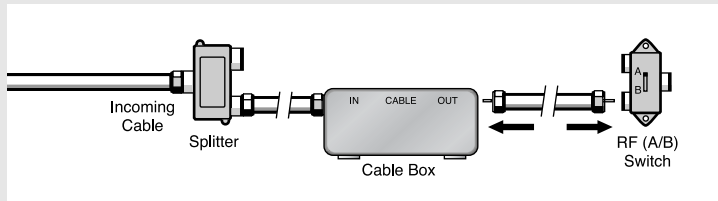

5

Connect another cable between the other OUT terminal on the splitter and the A-IN terminal on the RF (A/B) switch.

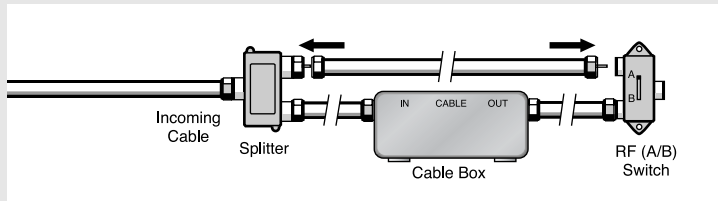

6

Connect the last coaxial cable between the OUT terminal on the RF (A/B) switch and the ANT 1 IN or ANT 2 IN terminal on the rear panel.

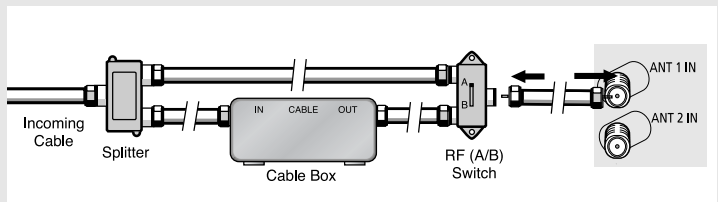

After you've made this connection, set the A/B switch to the "A" position for normal viewing. Set the A/B switch to the "B" position to view scrambled channels. (When you set the A/B switch to "B," you will need to tune your TV to the cable box's output channel, which is usually channel 3 or 4.)

Connecting a VCR

These instructions assume that you have already connected your TV to an antenna or a cable TV system (according to the instructions on pages 14~17). Skip step **1** if you have not yet connected to an antenna or a cable system.

1
Unplug the cable or antenna from the back of the TV.

2
Connect the cable or antenna to the ANTENNA IN terminal on the back of the VCR.

3
Connect a coaxial cable between the ANTENNA OUT terminal on the VCR and the antenna terminal on the TV.

4
Connect a set of audio cables between the AUDIO OUT jacks on the VCR and the AUDIO jacks (AV1~AV3) on the TV.
If you have a "mono" (non-stereo) VCR, use a Y-connector (not supplied) to hook up to the left and right audio input jacks of the TV. If your VCR is stereo, you must connect two cables.

5
Connect a video cable between the VIDEO OUT jack on the VCR and the VIDEO jack (AV1~AV3) on the TV.

Follow the instructions in "Viewing an External Signal Source" to view your VCR tape.

TV Rear Panel

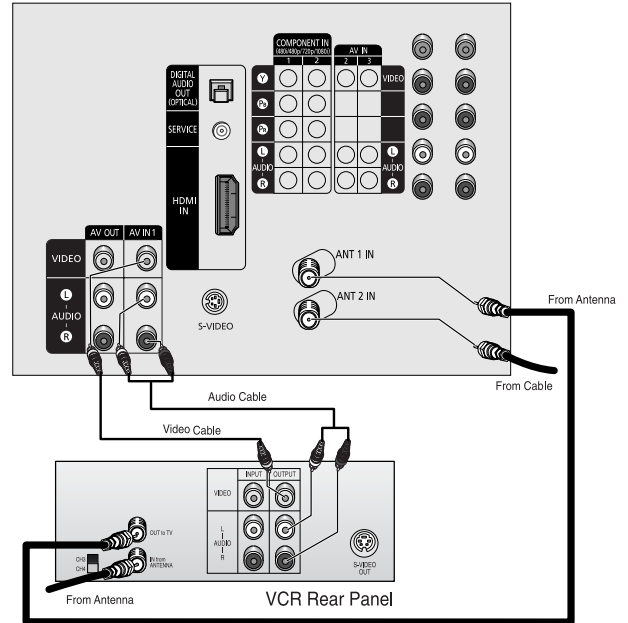

Ferrite Core

The ferrite core is used to attenuate undesired signals. When connecting cables, attach the ferrite core to the cable near the connector.

TV Rear Panel

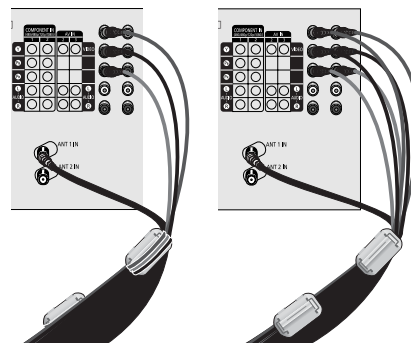

Connecting an S-VHS VCR

Your TV can be connected to an S-Video signal from an S-VHS VCR. (This connection delivers a better picture as compared to a standard VHS VCR.)

1

To begin, follow steps 1–3 in the previous section to connect the antenna or cable to your VCR and your TV.

2

Connect a set of audio cables between the AUDIO OUT jacks on the VCR and the AUDIO IN 1 jacks on the TV.

3

Connect an S-video cable between the S-VIDEO OUT jack on the VCR and the S-VIDEO jack on the TV.

TV Rear Panel

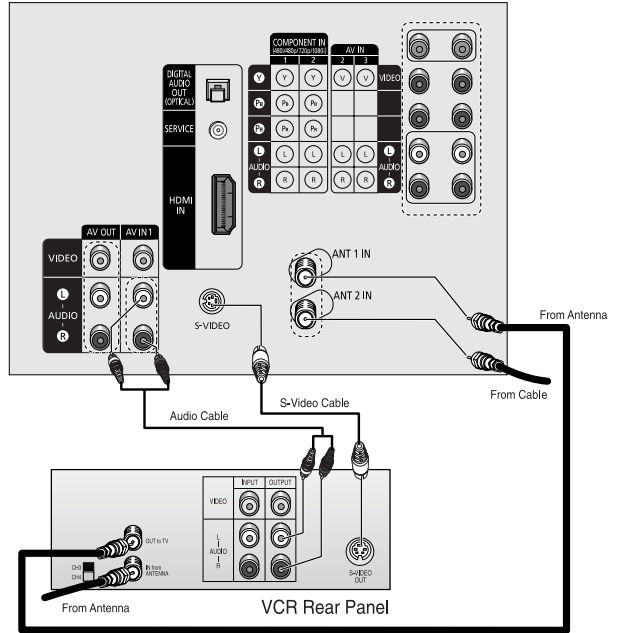

An S-video cable is usually included with an S-VHS VCR. (If not, check your local electronics store.)

Connecting a Second VCR to Record from the TV

Your TV can send out signals of its picture and sound to be recorded by a second VCR. To do this, connect your second VCR as follows:

1

Connect a set of audio cables between the AUDIO OUT jacks on the TV and the AUDIO IN jacks on the VCR. (The VCR input jacks might be either on the front or on back of the VCR.)

2

Connect a video cable between the VIDEO OUT jack on the TV and the VIDEO IN jack on the VCR.

Refer to your VCR's instructions for more information about how to record using this kind of connection.

TV Rear Panel

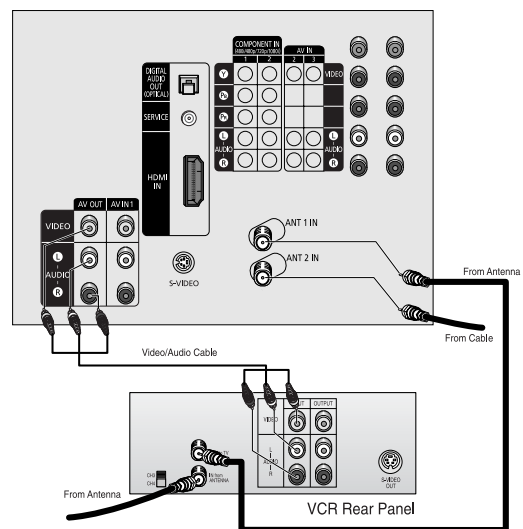

Connecting a DVD Player

Connecting to Y, P_B, P_R

The rear panel jacks on your TV make it easy to connect a DVD player to your TV.

1
Connect a set of audio cables between the COMPONENT 1 INPUT (L, R) or COMPONENT 2 INPUT (L, R) jacks on the TV and the AUDIO OUT jacks on the DVD player.

2
Connect a video cable between the COMPONENT 1 INPUT (Y, P_B, P_R) or COMPONENT 2 INPUT (Y, P_B, P_R) jacks on the TV and the DVD OUT (Y, P_B, P_R) jacks on the DVD player.

Note: For an explanation of Component video, see your DVD player's owner's manual.

TV Rear Panel

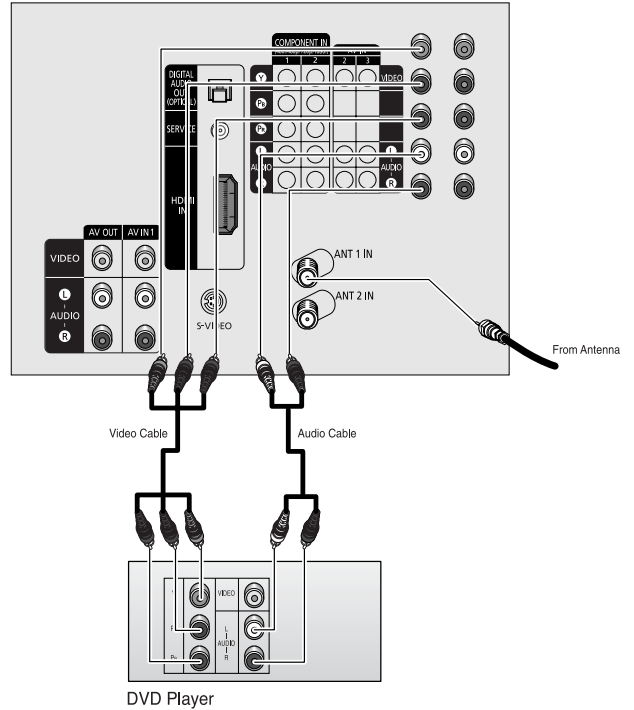

Connecting to Regular Audio and Video Jacks

1
Connect a set of audio cables between the AUDIO IN jacks (AV1~AV3) on the TV and the AUDIO OUT jacks on the DVD player.

2
Connect video cables between the VIDEO OUT jack on the DVD player and the VIDEO IN jack (AV1~AV3) on the TV.

TV Rear Panel

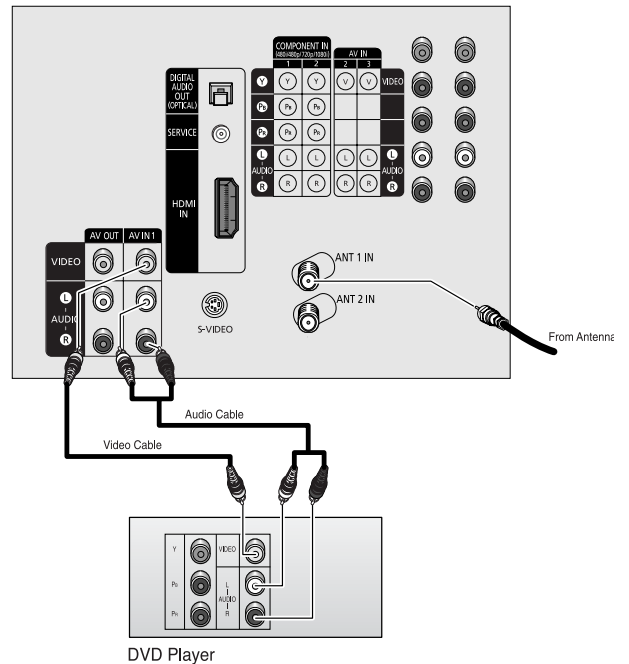

Connecting a Digital TV Set-Top Box (480p/720p/1080i)

Connecting to Y, P_B, P_R

Connect the Y, P_B, and P_R video outputs of the set-top box to their corresponding inputs on the TV. Next, connect the Left and Right audio from the set-top box to the corresponding L and R terminals on the TV. (The connections for a typical set-top box are shown below.)

1
Connect a coaxial cable to the ANTENNA IN terminal on the Set-Top Box and the antenna terminal on the TV.

2
Connect a set of audio cables between the COMPONENT 1 INPUT (L, R) or COMPONENT 2 INPUT (L, R) jacks on the TV and the AUDIO OUT jacks on the Set Top Box.

3
Connect a video cable between the COMPONENT 1 INPUT (Y, P_B, P_R) or COMPONENT 2 INPUT (Y, P_B, P_R) jacks on the TV and the VIDEO OUT (Y, P_B, P_R) jacks on the Set Top Box.

Note: For detailed information, refer to the Set Top Box instruction manual.

TV Rear Panel

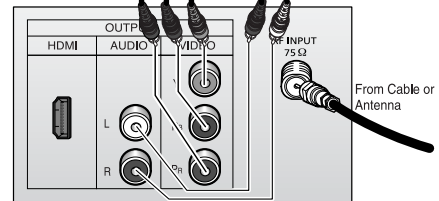
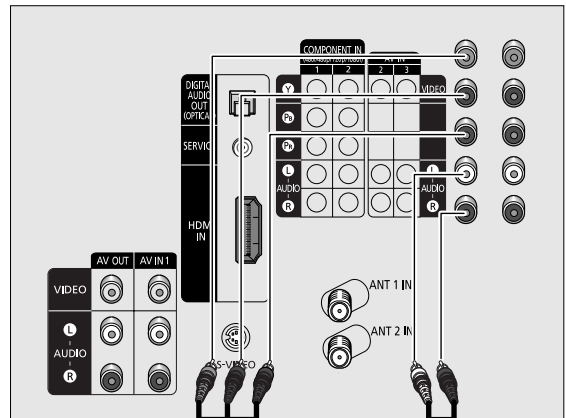

DTV Set-top Box

Connecting to HDMI(High Definition Multimedia Interface)

- 1** Connect a coaxial cable to the ANTENNA IN terminal on the Set-Top Box and the antenna terminal on the TV.
- 2** Connect in HDMI cable between the HDMI IN jack on the TV and the HDMI OUT jack on the Set Top Box.
- 3** Use a HDMI cable (commercially available) in order to digitally connect the TV with a DTV Set-top box.

TV Rear Panel

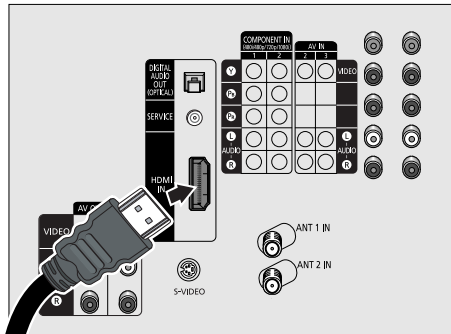

HDMI Cable

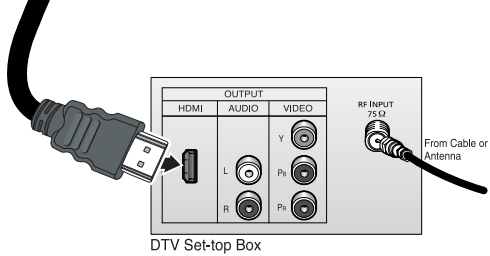

DTV Set-top Box

Connecting a Camcorder

The side panel jacks on your TV make it easy to connect a camcorder to your TV. They allow you to view the camcorder tapes without using a VCR. (Also see “Viewing an External Signal Source” on page 44).

1

Locate the A/V output jacks on the camcorder. They are usually found on the side or back of the camcorder.

2

Connect an audio cable between the AUDIO OUT jack on the camcorder and the AUDIO terminals on the TV.

3

Connect a video cable between the VIDEO OUT jack on the camcorder and the VIDEO (or S-VIDEO) terminal on the TV.

The audio-video cables shown here are usually included with a Camcorder. (If not, check your local electronics store.) If your camcorder is stereo, you need to connect a set of two cables.

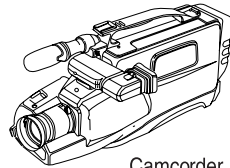
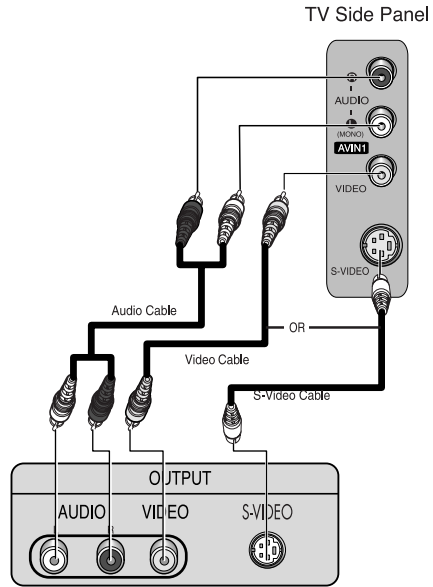

Connecting to a Digital Audio System

There are many types of audio systems on the market today.

A simplified illustration of an audio system is shown below. For more information, see your audio system owner's manual.

1

If your system has an optical digital audio input, connect it to the **OPTICAL OUT** jack on the TV.

Be certain to remove the black cover from the optical output before inserting the cable.

2

If your system has a optical digital audio input, **SAMSUNG** recommends you use the optical digital output on the TV.

TV Rear Panel

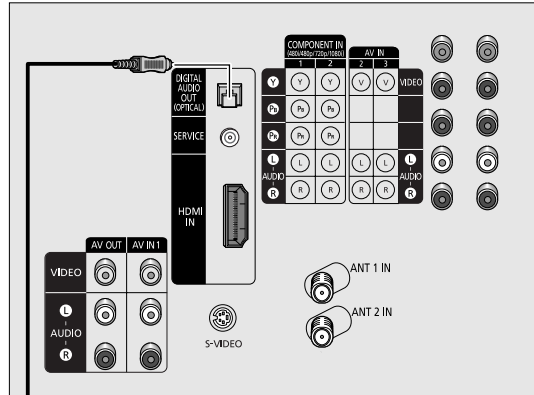

Digital Audio Rear Panel

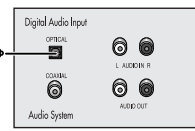

Connecting to an External Amplifier (Variable Audio Output)

The "AUDIO OUT" terminals cannot be used for external speakers. You must hook them up to an amplifier.

When an audio amplifier is connected to the "AUDIO OUT" terminals:
Decrease the gain (volume) of the audio amplifier, and adjust the volume level with the volume control on the TV.

TV Rear Panel

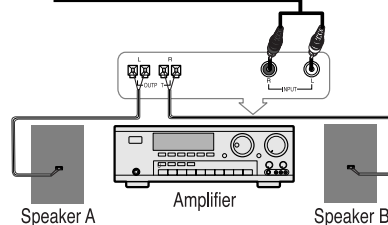
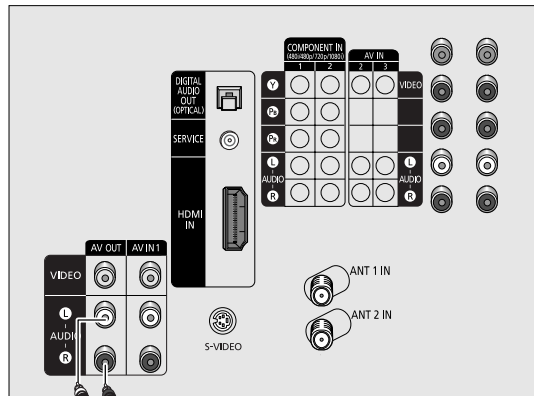

Installing Batteries in the Remote Control

1

Slide the back cover all the way out to open the battery compartment of the remote control.

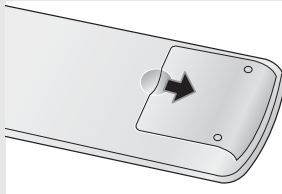

2

Install two AAA size batteries.

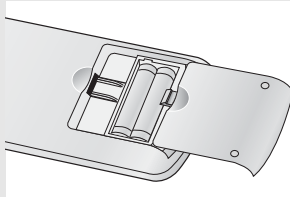

◀ Make sure to match the “+” and “-” ends of the batteries with the diagram inside the compartment.

3

Replace the cover.

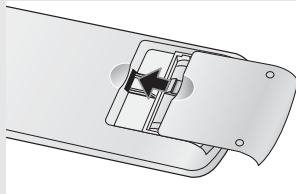

◀ Remove the batteries and store them in a cool, dry place if you won't be using the remote control for a long time.

The remote control can be used up to about 23 feet from the TV.

(Assuming typical TV usage, the batteries last for about one year.)

Chapter Three

OPERATION

Turning the TV On and Off

Press the **POWER** button.

You can also use the POWER button on the front panel.

Plug & Play Feature

When the TV is initially powered On, basic customer settings proceed automatically and subsequently: Setting the language, Antenna input check, Channel Memorize and Time Setting.

Note : The Plug & Play function operates after plugging in the TV for the first time.

1

Press the **POWER** button on the remote control.

The message "Menu language, channels and Time will be set." is displayed.

Press the **ENTER** button, then "Select the language of the OSD" is automatically displayed.

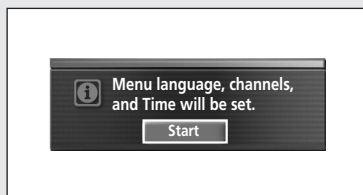

◀ Plug & Play feature doesn't work in the AV mode.

2

Press the **ENTER** button to enter the language.

Press the **▲** or **▼** button to select language, then the **ENTER** button.

"Select the antennas to memorize." is automatically displayed.



3

Press the **▲** or **▼** button to memorize the channels of the selected connection. Press the **ENTER** button to select "Start".

When selecting Cable TV : Press the **▲** or **▼** button to select "Cable", then press the **ENTER** button. Press the **▲** or **▼** button to select "STD", "HRC", or "IRC", then press the **ENTER** button.

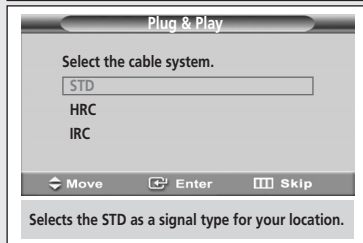
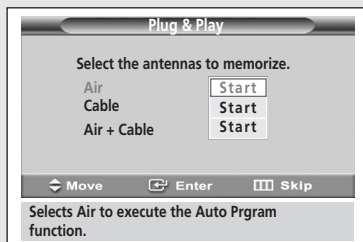

◀ STD, HRC, and IRC identify various types of cable TV systems. Contact your local cable company to identify the type of cable system that exists in your particular area.

continued...

4

The TV will begin memorizing all of the available channels.

After all the available channels are stored, the "Auto Program" menu reappears. Press the **MENU** button when channel memorization is complete.

"Set to daylight savings time." is automatically displayed.

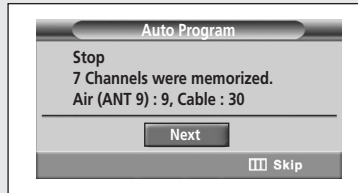
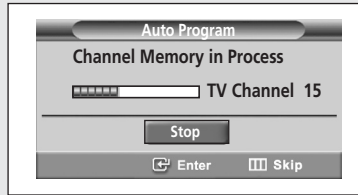

5

Press the **ENTER** button. Press the **▲** or **▼** button to select "Off" or "On", then the **ENTER** button.

"Select your time zone in which you live." is automatically displayed.

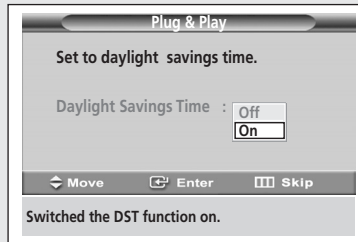

6

Press the **▲** or **▼** button to highlight the time zone for your local area (and to move the highlight to the appropriate time zone on the map of the United States). Press the **ENTER** button.

That's it. If you have received a digital signal, the time will be set automatically. If not, see page 44 to set the clock.



7

The message "Completed. Time will be updated automatically." is displayed. When you have finished, press the **ENTER** button.

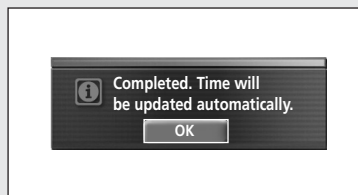

Viewing the Menu and On-Screen Displays

Viewing the Menu

1

With the power on, press the **MENU** button. The "Input" menu appears on the screen. Its left side has six icons: Input, Picture, Sound, Channel, Setup and Guide.

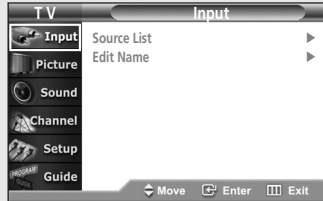

Press the ◀ or ▶ button to select one of six icons. Then press the **ENTER** button to access the icon's sub-menu.

2

Press the ▲ or ▼ button to move to items in the menu (The icon is selected.). Press the **ENTER** or ▶ button to enter items in the menu. Press the ▲/▼/◀/▶ button to change the selected items. Press the **MENU** or ◀ button to return to the previous menu.

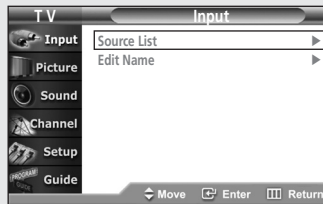

◀ You can also use the **MENU**, **CH**▲/▼, **VOL**+/-, and **ENTER** (ENTER) buttons on the control panel of the TV to make selections.

3

Press the **EXIT** button to exit.

Viewing the Display

The display identifies the current channel and the status of certain audio-video settings.

Press the **INFO** button on the remote control. The TV displays the current channel, the status of certain picture and sound settings and the current time.

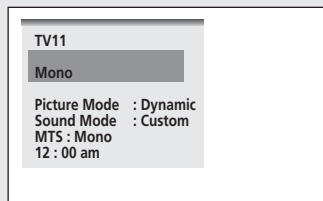

Selecting a Menu Language

1

Press the **MENU** button.

Press the **▲** or **▼** button to select "Setup", then press the **ENTER** button.

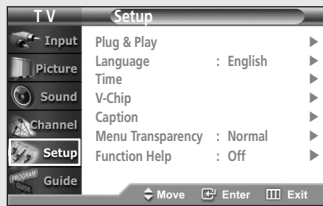

2

Press the **▲** or **▼** button to select "Language", then press the **ENTER** button.



3

Press the **▲** or **▼** button to select "English", "Spanish", or "French", then press the **ENTER** button.

Press the **EXIT** button to exit.



Selecting the Antenna Input

You can connect two different signal sources by choosing the antenna input (Air or Cable).

1

Press the **MENU** button.

Press the **▲** or **▼** button to select "Channel", then press the **ENTER** button.

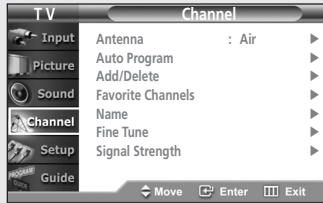

2

Press the **ENTER** button to select "Antenna".

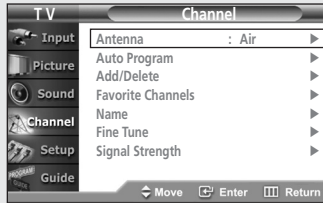

3

Press the **▲** or **▼** button to select "Air" or "Cable", then press the **ENTER** button.

Press the **EXIT** button to exit.

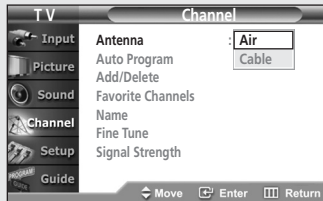

Alternate method:

Press the **ANTENNA** button repeatedly to select "Air" or "Cable".

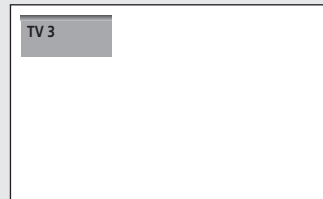

Memorizing the Channels

Your TV can memorize and store all of the available channels for both “off-air” (antenna) and cable channels. After the available channels are memorized, use the **CH \wedge** and **CH \vee** buttons to scan through the channels. This eliminates the need to change channels by entering the channel digits. There are three steps for memorizing channels: selecting a broadcast source, memorizing the channels (automatic) and adding/deleting channels (manual).

Selecting the Video Signal-source

Before your TV can begin memorizing the available channels, you must specify the type of signal source that is connected to the TV (i.e., an antenna or a cable system).

1

Press the **MENU** button.

Press the **▲** or **▼** button to select “Channel”, then press the **ENTER** button.

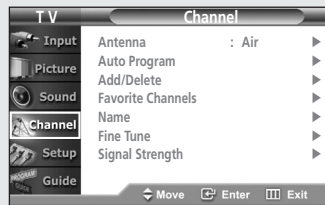

2

Press the **ENTER** button to select “Antenna”.

Press the **▲** or **▼** button to select “Air” or “Cable”, then press the **ENTER** button.

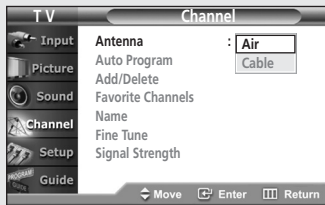

3

Press the **▲** or **▼** button to select “Auto Program”, then press the **ENTER** button.

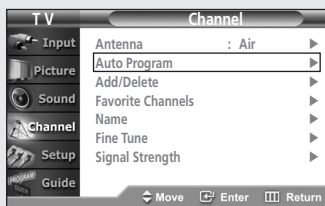

Alternate method:

Press the **AUTO. PROG** button on the remote control to select the Auto Program.

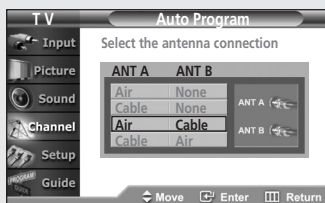

4

Press the ▲ or ▼ button to select antenna connection, then press the **ENTER** button.

When selecting the Cable TV system:

Press the ▲ or ▼ button to select "Cable", then press the **ENTER** button.
Press the ▲ or ▼ button to cycle through these choices: "STD", "HRC", or "IRC", then press the **ENTER** button.

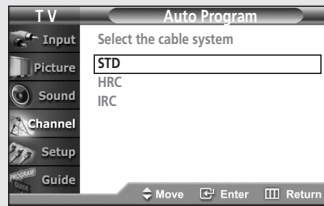
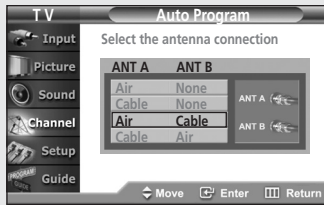

Air	None	ANT A : Air
Cable	None	ANT A : Cable
Air	Cable	ANT A : Air, ANT B : Cable
Cable	Air	ANT A : Cable, ANT B : Air

◀ STD, HRC, and IRC identify various types of cable TV systems. Contact your local cable company to identify the type of cable system that exists in your particular area.

Storing Channels in Memory

5

Press the ▲ or ▼ button to select the antenna to memorize, then press the **ENTER** button to select "Start".

The TV will begin memorizing all of the available channels.

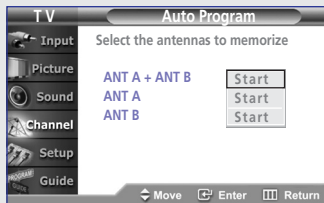
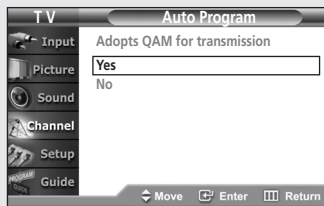

6

Press the **ENTER** button when channel memorization is completed. After pressing **ENTER**, it returns to the Channel menu.

Press the **EXIT** button to exit.

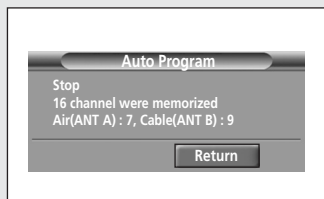
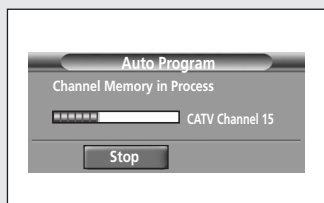

- ◀ Press the **ENTER** button at any time to interrupt the memorization process and return to the Channel menu.
- ◀ Note: The TV must be connected to an antenna in order to receive digital TV signals.
Even if a particular channel is deleted from the memory, you can always tune to that channel directly by using the number buttons on the remote control.
- ◀ Note: When Receiving a Digital Cable Signal : If your cable service signal does not comply with the ATSC(Advanced Television System Committee) requirements, this product may not operate properly.

Adding and Erasing Channels

To add channels that were not memorized (or to delete unwanted channels from memory):

1

Press the **MENU** button.

Press the **▲** or **▼** button to select "Channel", then press the **ENTER** button.



2

Press the **▲** or **▼** button to select "Add/Delete", then press the **ENTER** button.

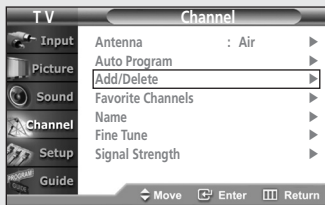

3

Repeatedly pressing the **ENTER** button will alternate between add channel and delete channel.

Press the number buttons (or CH **^**/**v** buttons) to switch to the appropriate channel, then repeat above.

Press the **EXIT** button to exit.

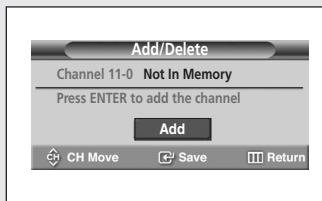

<Add channel>

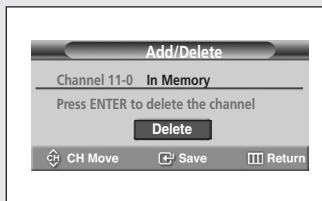

<Delete channel>

Alternate method:

Simply press the **ADD/DEL** button on the remote control to add channels that were not memorized or to delete unwanted channels from memory.

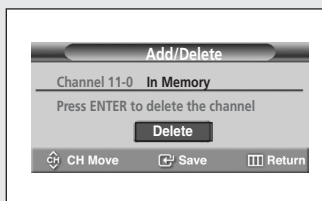

Changing Channels

Using the Channel Buttons

Press the **CH \wedge** or **CH \vee** button to change channel.

When you press **CH \wedge** or **CH \vee** , the TV changes channels in sequence. You will see all the channels that the TV has memorized. (The TV must have memorized at least three channels.) You will not see channels that were either erased or not memorized.

Using the Number Buttons

Use the number buttons to quickly tune to any channel.

Press the number buttons to go directly to a channel.
For example, to select channel 27, press "2" then "7".
The TV will change channels when you press the second number.

When you use the number buttons, you can directly select channels that were either erased or not memorized.

To select a channel over 100, press the +100 button. (For channel 122, press "+100", then "2", then "2".)

To change to single-digit channels (0–9) faster, press "0" before the single digit. (For channel "4", press "0", then "4".)

Using the PRE-CH Button to Select the Previous Channel

Press the **PRE-CH** button.
The TV changes to the last channel you were watching.



◀ To quickly switch between two channels that are far apart, tune to one channel, then use the number button to select the second channel. Then, use the **PRE-CH** button to quickly alternate between them.

Selecting Your Favorite Channels

You can store your favorite channels for each available input source (such as TV and CATV). This allows you to quickly and easily find frequently watched channels by pressing the **FAV.CH** button on the remote control.

To Store Your Favorite Channels:

1

Press the **MENU** button.

Press the **▲** or **▼** button to select "Channel", then press the **ENTER** button.

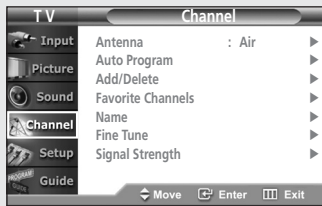

2

Press the **▲** or **▼** button to select "Favorite Channels", then press the **ENTER** button.

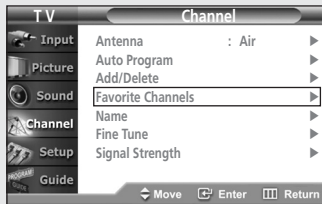

3

Press the **▲** or **▼** button to select a channel as a favorite channel, then press the **ENTER** button. Press the **ENTER** button again to deselect the selected channel.

Press the **EXIT** button to exit.

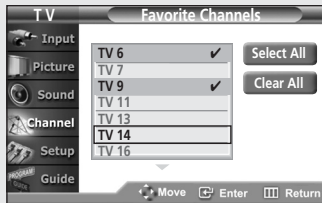

◀ Only memorized channels can be set as Favorite Channels.

◀ Select All : Press to select all channels.
Clear All : Press to clear all channels.

To View Your Favorite Channels:

Press the **FAV.CH** button on the remote control repeatedly to jump from one favorite channel to another.

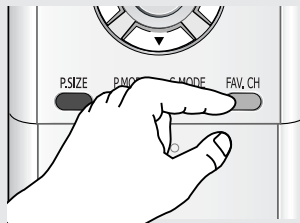

Analog Labeling the Channels

Use this feature to assign an easy-to-remember label to any channel (i.e., “CBS”, “ESPN”, “PBS2”, “CNN1”, etc.) A label consists of five fields, where each field is a letter, a number or a blank. When the **INFO** button is pressed, the channel label will appear next to the channel number.

1

Press the **CH** \wedge or **CH** \vee button to tune to the channel that will be labeled.

2

Press the **MENU** button.

Press the \blacktriangle or \blacktriangledown button to select “Channel”, then press the **ENTER** button.



3

Press the \blacktriangle or \blacktriangledown button to select “Name”, then press the **ENTER** button.

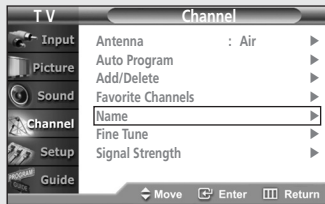

4

Press the **ENTER** button again. (Each label has five fields).

Press the \blacktriangle or \blacktriangledown button to select a letter, a number or a blank. (Results in this sequence: A...Z, blank, /, 0 ... 9.)

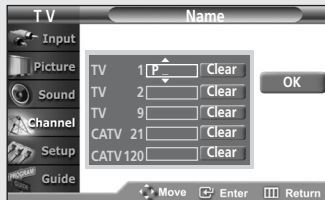

5

Press the \blacktriangleright button to switch to the next field, which will be selected.

Select a second letter or digit by pressing the \blacktriangle or \blacktriangledown button, as above.

Repeat the process to select the last three digits.

Press the **EXIT** button to exit.

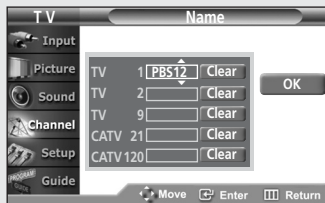

Notes

- Only analog TV channels can be labelled.
- If you add or delete the TV channel, the labelled channels list will also be added or deleted.

Picture Control

You can use the on-screen menus to change the contrast, brightness, sharpness, color and tint according to personal preference.

Using Automatic Picture Settings

Your TV has automatic picture settings (“Dynamic”, “Standard”, and “Movie”) that are preset at the factory. You can activate either Dynamic, Standard or Movie by pressing **P.MODE** (or by making a selection from the menu). Or, you can select “Custom” which automatically recalls your personalized picture settings.

1

Press the **MENU** button.

Press the **▲** or **▼** button to select “Picture”, then press the **ENTER** button.

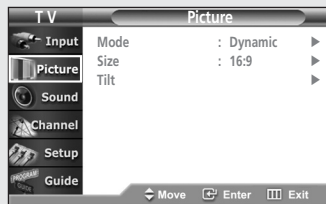

2

Press the **ENTER** button to select “Mode”.

Press the **ENTER** button again.

Press the **▲** or **▼** button to select a particular item, then press the **ENTER** button.

Press the **EXIT** button to exit.

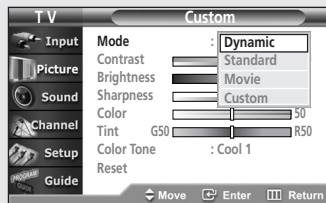

Alternate method:

Simply press the **P.MODE** button on the remote control to select one of the standard picture settings.



- Choose “Dynamic” for viewing the TV during the day or when there is a bright light in the room.
- Choose “Standard” for the standard factory settings.
- Choose “Movie” when viewing a Movie.
- Choose “Custom” if you want to adjust the settings according to personal preference.

Customizing the Picture

You can use the on-screen menus to change the “Contrast”, “Brightness”, “Sharpness”, “Color”, “Tint”, and “Color Tone” according to personal preference.

1

Press the **MENU** button.

Press the **▲** or **▼** button to select “Picture”, then press the **ENTER** button.

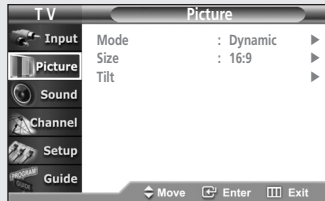

2

Press the **ENTER** button to select “Mode”.
Press the **ENTER** button again.

Press the **▲** or **▼** button to select a particular item (“Dynamic”, “Standard”, “Movie”, or “Custom”), then press the **ENTER** button.

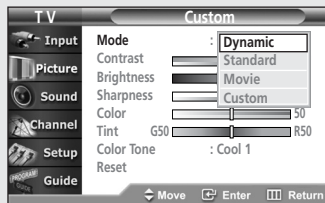

3

Press the **▲** or **▼** button to select a particular item (“Contrast”, “Brightness”, “Sharpness”, “Color”, or “Tint”), then press the **ENTER** button.

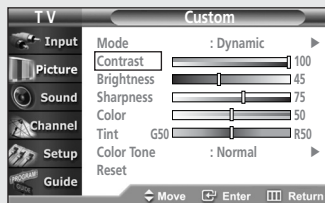

4

Press the **◀** or **▶** button to increase or decrease the value of a particular item.

Press the **▲** or **▼** button to select other items.

When you have finished, press the **ENTER** button.



5

Press the ▲ or ▼ button to select “Color Tone”, then press the **ENTER** button.

Press the ▲ or ▼ button to select a particular item (“Cool 2”, “Cool 1”, “Normal”, “Warm 1”, or “Warm 2”), then press the **ENTER** button.

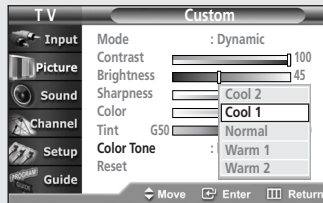

Resetting the Picture Settings to the Factory Defaults

6

Press the ▲ or ▼ button to select “Reset”, then press the **ENTER** button.

The reset function is set for each mode (“Dynamic”, “Standard”, “Movie”, or “Custom”).

The previously adjusted settings will be reset to the factory defaults.

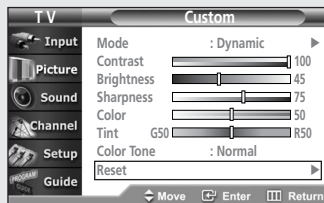

Sound Control

Adjusting the Volume

Press the **VOL +** or **VOL -** buttons to increase or decrease the volume.

Using Mute

At any time, you can temporarily cut off the sound by using the **MUTE** button.

1

Press the **MUTE** button and the sound cuts off. The "MUTE" is displayed.



2

To turn MUTE off, press the **MUTE** button again, or press either the **VOL +** or **VOL -** button.

Customizing the Sound

The sound settings can be adjusted to suit your personal preference. (Alternatively, you can use one of the "automatic" settings. See next page.)

1

Press the **MENU** button.

Press the **▲** or **▼** button to select "Sound", then press the **ENTER** button.

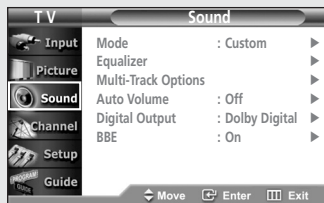

2

Press the **▲** or **▼** button to select "Equalizer", then press the **ENTER** button.

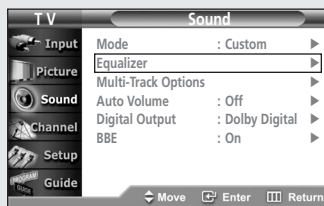

3

Press the **◀** or **▶** button to select a particular item to be changed.

Press the **▲** or **▼** button to increase or decrease the value of a particular item.

Press the **EXIT** button to exit.

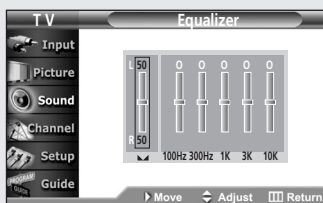

Using Automatic Sound Settings

Your TV has automatic sound settings (“Standard”, “Music”, “Movie” and “Speech”) that are preset at the factory. You can activate these sound settings by pressing the **S.MODE** button (or by making a selection from the menu), or you can select “Custom”, which automatically recalls your personalized sound settings.

1

Press the **MENU** button.

Press the **▲** or **▼** button to select “Sound”, then press the **ENTER** button.

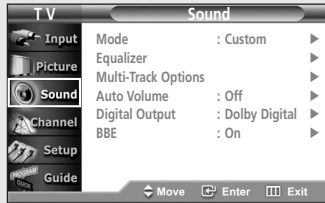

2

Press the **ENTER** button to select “Mode”.

Press the **▲** or **▼** button to select a particular item, then press the **ENTER** button.

Press the **EXIT** button to exit.

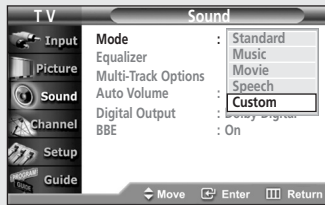

Alternate method:

Press the **S.MODE** button on the remote control repeatedly to select one of the standard sound settings.



- Choose “Standard” for the standard factory settings.
- Choose “Music” when watching music videos or concerts.
- Choose “Movie” when watching movies.
- Choose “Speech” when watching a show that is mostly dialogue (i.e., news).
- Choose “Custom” to recall your personalized settings.

Setting the Clock

Setting the clock is necessary in order to use the various timer features of the TV. Also, you can check the time while watching the TV. (Just press the **INFO** button.)

Option 1: Setting the Clock Manually

1

Press the **MENU** button.

Press the **▲** or **▼** button to select "Setup", then press the **ENTER** button.

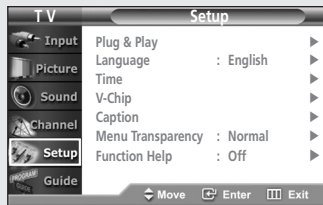

2

Press the **▲** or **▼** button to select "Time", then press the **ENTER** button.

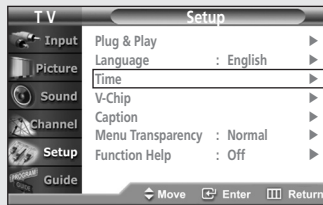

3

Press the **ENTER** button to select "Clock".

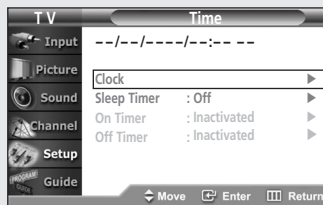

4

Press the **ENTER** button to select "Clock Mode".

Press the **▲** or **▼** button to select "Manual", then press the **ENTER** button.

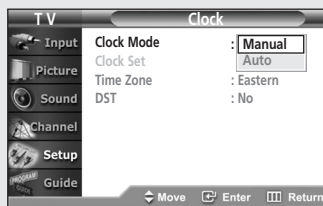

5

Press the **▲** or **▼** button to select "Clock Set", then press the **ENTER** button.

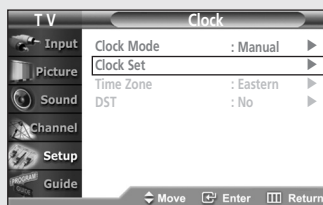

6

Press the ◀ or ▶ button to move to “Month”, “Day”, “Year”, “Hour”, “Minute”, or “am/pm”. Set the date and time you want by pressing the ▲ or ▼ button, then press the **ENTER** button.

Press the **EXIT** button to exit.

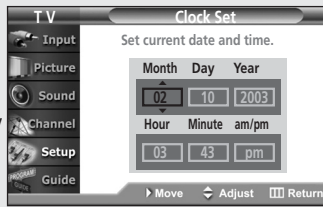

- ◀ The current time will appear every time you press the **INFO** button.
- ◀ You can set the Month, Day, Year, Hour, and Minute directly by pressing the number buttons on the remote control.

Option 2: Setting the Clock Automatically

The Clock can be set automatically if you are receiving a digital signal.

1

Press the **MENU** button.

Press the **▲** or **▼** button to select "Setup", then press the **ENTER** button.



2

Press the **▲** or **▼** button to select "Time", then press the **ENTER** button.

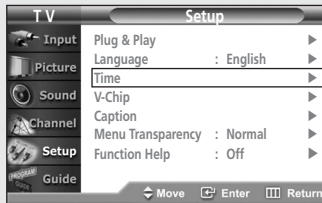

3

Press the **ENTER** button to select "Clock".

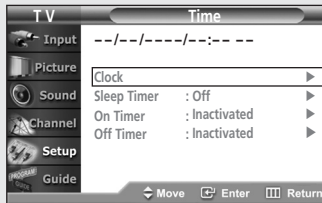

4

Press the **ENTER** button to select "Clock Mode".

Press the **▲** or **▼** button to select "Auto", then press the **ENTER** button.

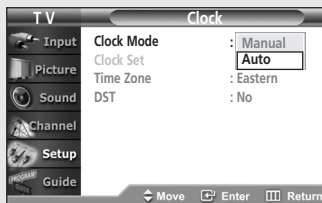

5

Press the **▲** or **▼** button to select "Time Zone", then press the **ENTER** button.

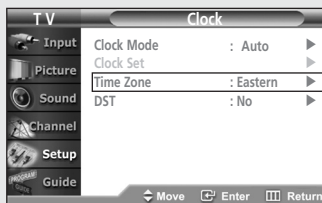

Note

- Certain broadcasts may not transmit the correct time. In this case, set the time manually.

6

Press the ▲ or ▼ button to select the time zone for your local area (and to move highlight to the appropriate time zone on the map of the United States).
Press the **ENTER** button.
The time will be set automatically.



- ◀ The set time can be changed according to the broadcasting station and signal when you set up Auto Time.
If there is a difference between the real time and set time, please use “Manual Time Setup”.

7

Press the ▲ or ▼ button to select “DST”, then press the **ENTER** button.

Press the ▲ or ▼ button to select “No” or “Yes”, then press the **ENTER** button.

Press the **EXIT** button to exit.

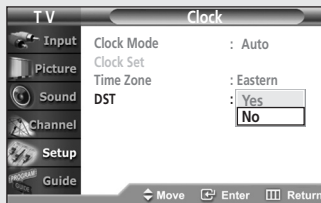

Viewing an External Signal Source

Use the remote control to switch between viewing signals from connected equipment, such as a VCR, DVD, Set-Top box and the TV source (broadcast or cable).

Setting the Signal Source

1

Press the **MENU** button.

Press the **ENTER** button to select "Input".

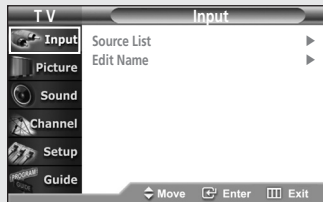

2

Press the **ENTER** button to select "Source List".

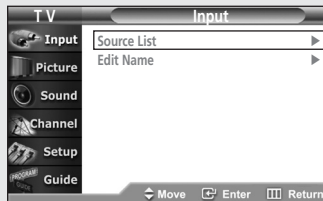

3

Press the **▲** or **▼** button to select signal source, then press the **ENTER** button

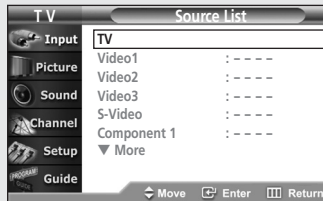

When you connect equipment to the TV, you can choose between the following sets of jacks : Video 1, S-Video on the TV's side panel or Video 1, Video 2, Video 3, S-Video, Component 1, Component 2 or **HDMI** on the TV's rear panel.

Alternate method:

Simply press the **TV/VIDEO** or **TV/COMP.** button on the remote control to select an External Signal Source.

TV/VIDEO : Video 1, Video 2, Video 3, S-Video.

TV/COMP. : Component 1, Component 2, **HDMI**.

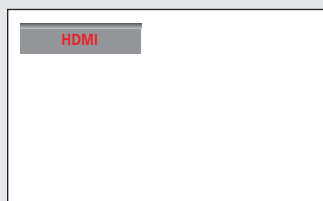

Assigning Names to External Input Mode

This feature enables you to name the input source you have connected.

1

Press the **MENU** button.

Press the **ENTER** button to select "Input".

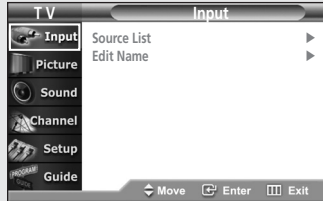

2

Press the **▲** or **▼** button to select "Edit Name", then press the **ENTER** button.

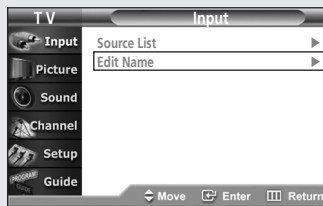

3

Press the **ENTER** button. Press the **▲** or **▼** button to select the external device: VCR, DVD, D-VHS, Cable STB, HD STB, Satellite STB, PVR STB, AV Receiver, DVD Receiver, GAME, Camcorder, Combo, PC, VOD STB, TV.

Set other signal sources (Video2, Video3, S-Video, Component1, Component2, HDMI) using the same method as listed above.

Press the **EXIT** button to exit.



Chapter Four

SPECIAL FEATURES

Analog Fine Tuning Analog Channels

The Fine Tuning function let you manually adjust the TV's tuner if you have difficulty tuning analog channels.

1

Press the **MENU** button.

Press the **▲** or **▼** button to select "Channel", then press the **ENTER** button.



2

Press the **▲** or **▼** button to select "Fine Tune", then press the **ENTER** button.

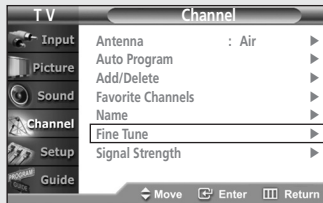

3

Press the **◀** or **▶** button to adjust the fine tuning.

To store the fine tuning setting in the TV's memory, press the **ENTER** button.

To reset the fine tuning to "0", press the **▼** button to select "Reset", then press the **ENTER** button.

Press the **EXIT** button to exit.

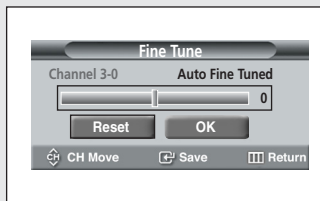

Note

- Only analog TV channels can be fine tuned.

Digital Checking the Digital-Signal Strength

Unlike analog channels, which can vary in reception quality from “snowy” to clear, digital (HDTV) channels have either perfect reception quality or you will not receive them at all. So, unlike analog channels, you cannot fine tune a digital channel. You can, however, adjust your antenna to improve the reception of available digital channels.

1

Press the **MENU** button.

Press the **▲** or **▼** button to select “Channel”, then press the **ENTER** button.

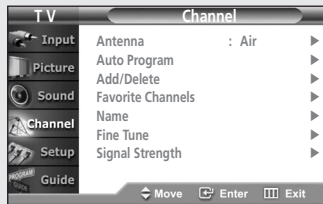

2

Press the **▲** or **▼** button to select “Signal Strength”, then press the **ENTER** button.

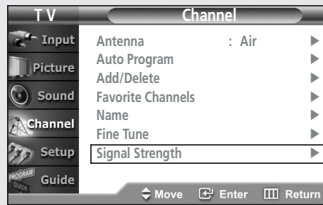

3

If the signal strength meter indicates that the signal is weak, physically adjust your antenna to increase the signal strength. Continue to adjust the antenna until you find the best position with the strongest signal.

Press the **EXIT** button to exit.

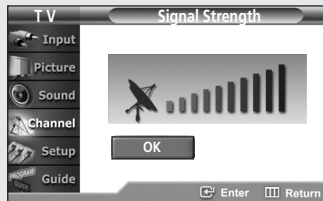

Note

- “No Signal” may appear on the screen depending on the broadcasting station conditions, even though an incoming broadcast signal exists.

Changing the Screen Size

1

Press the **MENU** button.

Press the **▲** or **▼** button to select "Picture", then press the **ENTER** button.

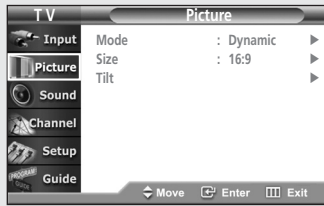

2

Press the **▲** or **▼** button to select "Size", then press the **ENTER** button.

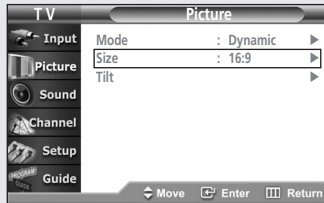

3

Press the **◀** or **▶** button to select the screen format you want.

Press the **EXIT** button to exit.

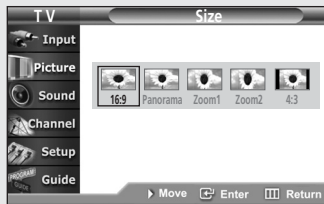

TX-R2675WH/TX-R2678WH/
TX-R3075WH

Alternate method:

Simply press the **P.SIZE** button on the remote control to change screen size.

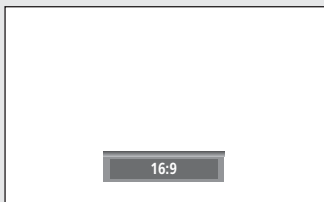

- 16:9 : Sets the picture to 16:9 wide mode.
- Panorama : Use this mode for the wide aspect ratio of a panoramic picture. (Wide TV)
- Zoom 1 : Magnifies the size of the picture on the screen.
- Zoom 2 : Expands the Zoom 1 format picture.
- 4:3 : Sets the picture to 4:3 normal mode.

Notes

Changing the Screen Format feature availability depends on the current broadcasting signal format.

<Wide TV>

- Analog signal : 16:9 → Panorama → Zoom1 → Zoom2 → 4:3
- Digital signal(SD) : 16:9 → Panorama → Zoom1 → Zoom2 → 4:3
- Digital signal(HD) : 16:9 → 4:3

<Normal(4:3) TV>

- Analog signal : Normal(4:3) → Zoom1 → Zoom2 → 16:9
- Digital signal : Normal(4:3) → 16:9

Tilt

Due to the Earth's magnetic field there may be some minor image tilt depending on the TV's location. When this occurs, follow the steps below.

1

Press the **MENU** button.

Press the ▲ or ▼ button to select "Picture", then press the **ENTER** button.

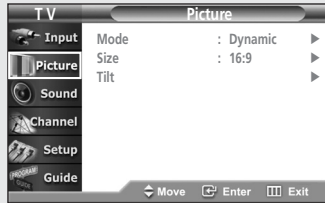

2

Press the ▲ or ▼ button to select "Tilt", then press the **ENTER** button.

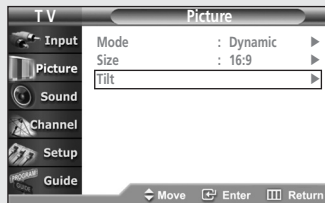

3

Press the ◀ and ▶ buttons to adjust screen Tilt, then press the **ENTER** button.

Press the **EXIT** button to exit.



Using the R.Surf Feature

This feature allows you to set the TV to return to a particular channel after a certain amount of time. For example, you may be watching a channel when commercials start. You can set the R.Surf to “5 minutes”, then switch channels. After minutes, the TV will return to the original channel. To use the R.Surf feature:

1

While you are watching the channel to which you want to return, press **R.SURF**. The on-screen display will read “SURF Off”.

A screenshot of a television screen showing the text "SURF Off" in a grey box at the top left.

2

Press **R.SURF** again to set the timer in thirty second intervals, up to five minutes.

A screenshot of a television screen showing the text "SURF 0 : 30" in a grey box at the top left.

3

The time you set will begin counting down on the screen. When the time runs out, the TV will return to the channel you were watching when you set the timer.

Extra sound settings (Auto Volume, BBE)

Auto Volume

Each broadcasting station has its own signal conditions, which can make it necessary to adjust the volume every time the channel is changed. “Auto volume” lets you automatically adjust the volume of the desired channel by lowering the sound output when the modulation signal is high or by raising the sound output when the modulation signal is low.

1

Press the **MENU** button.

Press the **▲** or **▼** button to select “Sound”, then press the **ENTER** button.

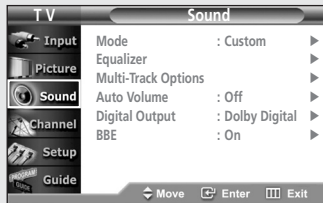

2

Press the **▲** or **▼** button to select “Auto Volume”, then press the **ENTER** button.

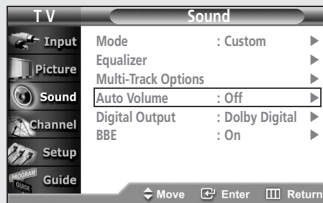

3

Press the **▲** or **▼** button to select “On”, then press the **ENTER** button.

Press the **EXIT** button to exit

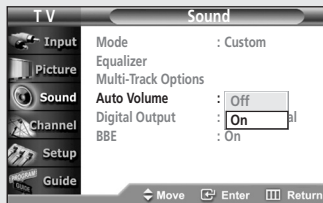

BBE

BBE is a built-in effect that adds clarity, punch and dynamics to the sound.

1

Press the **MENU** button.

Press the **▲** or **▼** button to select “Sound”, then press the **ENTER** button.

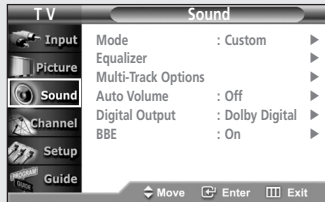

2

Press the **▲** or **▼** button to select “BBE”, then press the **ENTER** button.

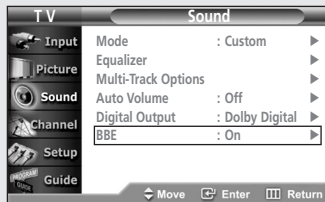

3

Press the **▲** or **▼** button to select “On”, then press the **ENTER** button.

Press the **EXIT** button to exit.

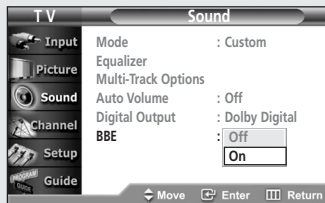

Alternate method:

Press the **BBE** button on the remote control repeatedly to select “BBE On” or “BBE Off”.



Choosing a Multi-Channel Sound (MTS) track

Digital

When a Digital Signal is received

The digital-TV transmission system is capable of simultaneous transmission of many audio tracks (for example, simultaneous translations of the program into foreign languages). The availability of these additional “multitracks” depends upon the program.

1

Press the **MENU** button.

Press the **▲** or **▼** button to select “Sound”, then press the **ENTER** button.

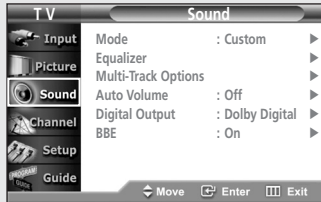

◀ Quick way to access the MTS menu: Just press the “MTS” button on the remote control. You can listen in a language other than the favorite language by pressing the MTS button.

2

Press the **▲** or **▼** button to select “Multi-Track Options”, then press the **ENTER** button.

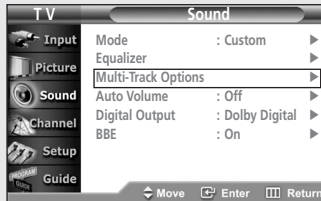

◀ The text at the bottom of the menu tells you if the incoming audio is Spanish, French or English.

3

Press the **ENTER** button to select “Preferred Language”.

Press the **▲** or **▼** button to choose the English, Spanish, French, then press the **ENTER** button.

Press the **EXIT** button to exit

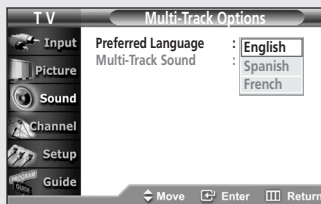

Alternate method:

Simply press the **MTS** button on the remote control to select language.



Analog When an Analog Signal is received

Depending on the particular program being broadcast, you can listen to Mono, Stereo or a SAP.

1

Press the **MENU** button.

Press the **▲** or **▼** button to select “Sound”, then press the **ENTER** button.

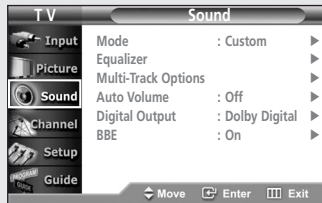

2

Press the **▲** or **▼** button to select “Multi-Track Options”, then press the **ENTER** button.

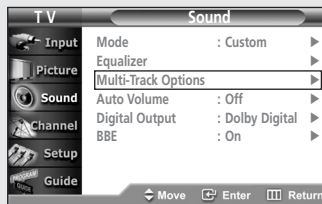

3

Press the **▲** or **▼** button to select “Multi-Track Sound”, then press the **ENTER** button.

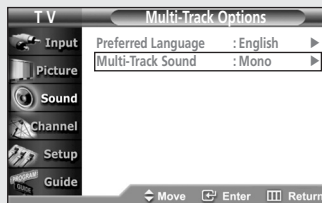

4

Press the **▲** or **▼** button to choose the submenu (Mono, Stereo, SAP) you want, then press the **ENTER** button.

Press the **EXIT** button to exit

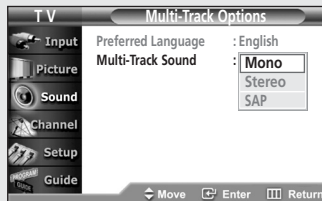

Alternate method:

Simply press the **MTS** button on the remote control to select Mono, Stereo or SAP.

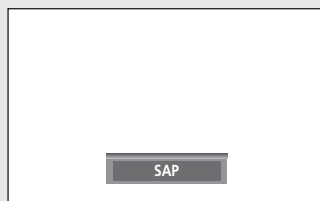

- Choose “Stereo” for channels that are broadcasting in stereo.
- Choose “Mono” for channels that are broadcasting in mono, or if you are having difficulty receiving a stereo signal.
- Choose “SAP” to listen to the Secondary Audio Program, which is usually a foreign-language translation.

Digital Choosing a Digital Sound Format

Digital sound can be output from the rear-panel connector on your TV. The digital sound output is optical connector labeled “DIGITAL AUDIO OUT (OPTICAL)” After connecting an optical digital-audio component, you must specify the transmission format (Dolby or PCM, as appropriate to your digital audio component).

1

Press the **MENU** button.

Press the **▲** or **▼** button to select “Sound”, then press the **ENTER** button.

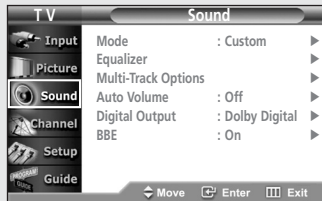

2

Press the **▲** or **▼** button to select “Digital Output”, then press the **ENTER** button.

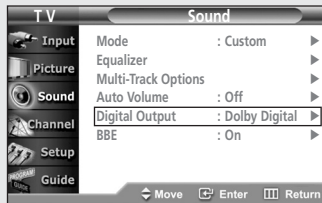

3

Press the **▲** or **▼** button to select “Dolby Digital” or “PCM”, then press the **ENTER** button.

Press the **EXIT** button to exit.

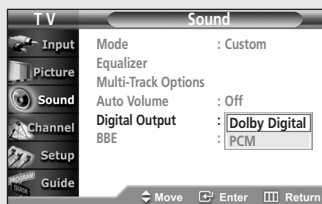

Manufactured under license from Dolby Laboratories.

“Dolby” and the double D-symbol are trademarks of Dolby Laboratories.



Setting the On/Off Timer

1

Press the **MENU** button.

Press the **▲** or **▼** button to select "Setup", then press the **ENTER** button.

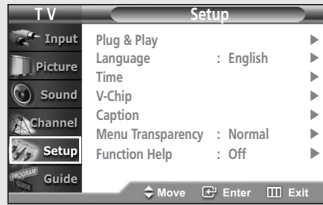

2

Press the **▲** or **▼** button to select "Time", then press the **ENTER** button.

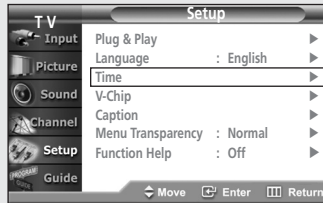

3

Press the **▲** or **▼** button to select "On Timer", then press the **ENTER** button.

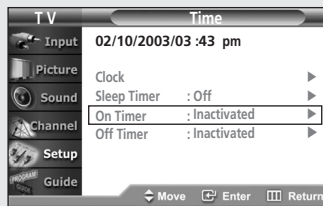

4

Press the **▲** or **▼** button to adjust "Hour", then press the **▶** button to move to the next step. Set other items using the same method as listed above. When finished, press the **MENU** button to return.

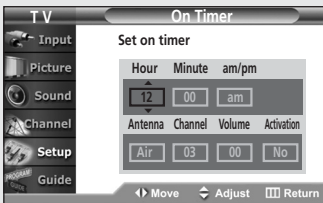

5

Set the Off Timer, press the **▲** or **▼** button to select "Off Timer", then press the **ENTER** button.

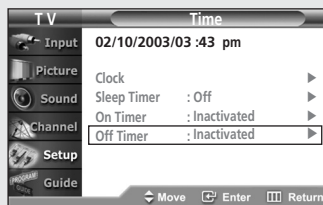

6

Press the **▲** or **▼** button to adjust "Hour", then press the **▶** button to move to the next step. Set other items using the same method as listed on the previous page. When finished setting the timer, press the **EXIT** button to exit.

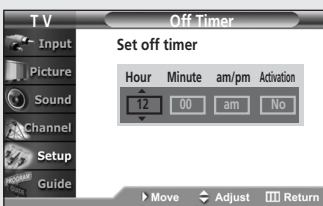

◀ Before using the timer, you must set the TV's clock. (See "Setting the Clock" on page 42).

◀ The current time will appear every time you press the **INFO** button.

◀ You can set the Hour, Minute, Channel, and Volume directly by pressing the number buttons on the remote control.

◀ **Auto Power Off**
When you set the timer "On", the television will eventually turn off, if no controls are operated for 3 hours after the TV was turned on by timer. This function is only available in timer "On" mode and prevents overheating or leakages, which may occur if a TV is on for too long (on holiday, for example).

Setting the Sleep Timer

The sleep timer automatically shuts off the TV after a preset time (from 30 to 180 minutes).

1

Press the **MENU** button.

Press the **▲** or **▼** button to select "Setup", then press the **ENTER** button.



2

Press the **▲** or **▼** button to select "Time", then press the **ENTER** button.

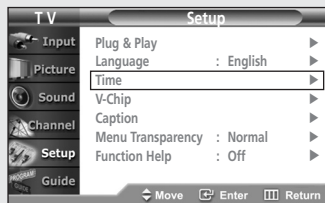

3

Press the **▲** or **▼** button to select "Sleep Timer", then press the **ENTER** button.

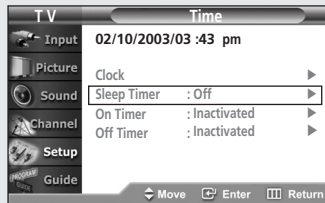

4

Press the **▲** or **▼** button to adjust to the minute you want, then press the **▶** button to move to the next step.

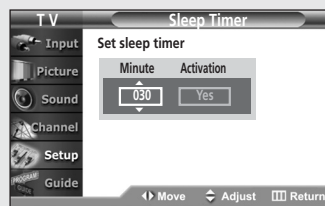

5

Press the **▲** or **▼** button to select "Yes" or "No", then press the **ENTER** button.

Press the **EXIT** button to exit.

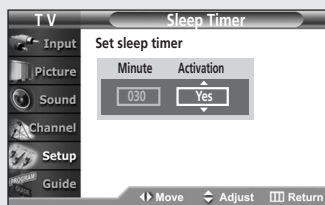

Alternate method:

Simply press the **SLEEP** button on the remote control repeatedly until the appropriate time interval appears (any of the preset values from "30min" to "180

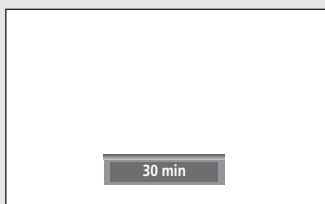

Using the V-Chip

Access to channels and programs is controlled by a password (i.e., a 4-digit secret code that is defined by the user). The on-screen menu will instruct you to assign a password (and you can change it later, if necessary).

How to Change Your Password

1

Press the **MENU** button.

Press the **▲** or **▼** button to select "Setup", then press the **ENTER** button.



2

Press the **▲** or **▼** button to select "V-Chip", then press the **ENTER** button.

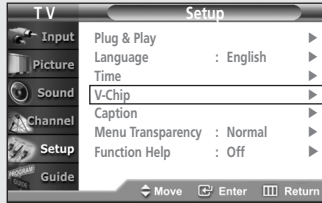

3

The "Enter your PIN" screen will appear. Enter your 4-digit PIN number.

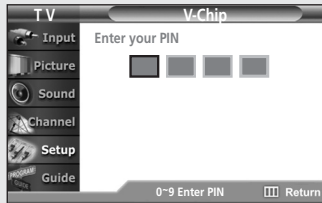

4

The "V-Chip" menu is displayed.

Press the **▲** or **▼** button to select "Change PIN", then press the **ENTER** button.

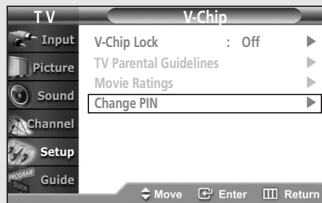

5

Press the number buttons (0 – 9) on the remote control to enter your current password.

Press the number buttons (0 – 9) to enter a new password.

Re-enter the new password to confirm.

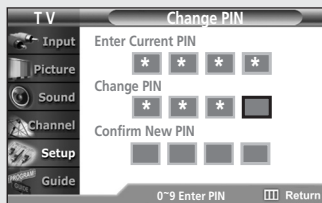

- ◀ The default PIN for a new TV set is "0 0 0 0".
- ◀ If you forget the PIN, press the remote control buttons in the following sequence, which resets the PIN to 0-0-0-0: **POWER** (Off), **MUTE**, **8**, **2**, **4**, **POWER** (On).

How to Set up Restrictions Using the “TV Parental Guidelines”

The parental restrictions can be set up using either of two methods: The “TV Parental Guidelines” or “MPAA Rating”.

1

Press the **MENU** button.

Press the **▲** or **▼** button to select “Setup”, then press the **ENTER** button.



2

Press the **▲** or **▼** button to select “V-Chip”, then press the **ENTER** button.

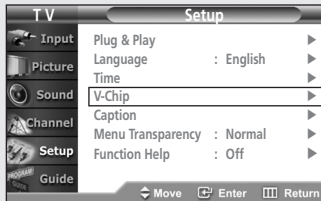

3

Enter your password correctly.

Press the **ENTER** button to select “V-Chip Lock”. Press the **▲** or **▼** button to select “Yes”, then press the **ENTER** button.

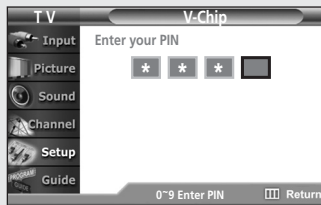

4

Press the **▲** or **▼** button to select “TV Parental Guidelines”, then press the **ENTER** button.

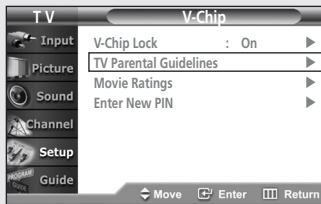

5

You can independently lock the TV ratings. The locked TV (FCC) ratings are indicated by the symbol “”.

Press the **▲/▼/◀/▶** buttons and the **ENTER** button to activate the appropriate restrictions for TV (FCC) rating system.

Pressing the **ENTER** button repeatedly will activate or deactivate the appropriate restrictions for TV (FCC) rating system.

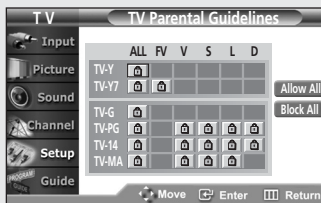

TV-Y	Young children
TV-Y7	Children 7 and over

TV-G	General audience
TV-PG	Parent Guidance
TV-14	Viewers 14 and over
TV-MA	Mature audience

- ◀ Allow All : Press to unlock all TV ratings.
- Block All : Press to lock all TV ratings.
- ◀ Note: These categories consist of two separate groups: TV-Y and TV-Y7 (young children through age 7), and TV-G through TV-MA (everybody else).
- The restrictions for these two groups work independently: If a household includes very young children as well as young adults, the TV guidelines must be set up separately for each age group. (See page 63.)

How to Set up Restrictions using the Movie Ratings: G, PG, PG-13, R, NC-17, X, NR

The Movie rating system uses the Motion Picture Association of America (MPAA) system, and its main application is for movies.

When the Rating Controls is on, the TV will automatically block any programs that are coded with objectionable ratings (either MPAA or TV-Ratings).

1

Press the **MENU** button.

Press the **▲** or **▼** button to select "Setup", then press the **ENTER** button.

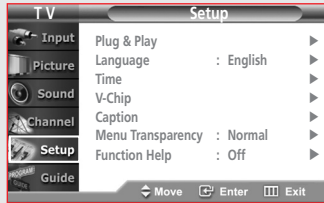

2

Press the **▲** or **▼** button to select "V-Chip", then press the **ENTER** button.

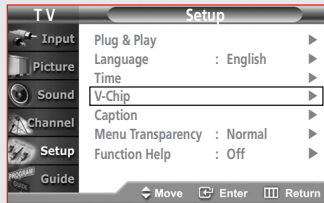

3

Enter your password correctly.

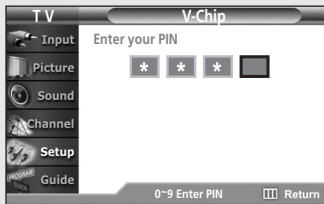

4

Press the **▲** or **▼** button to select "Movie Ratings", then press the **ENTER** button.

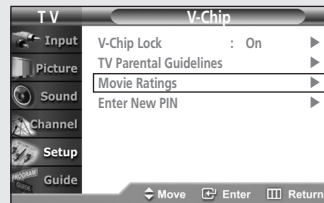

5

You can independently lock the movie ratings. The locked movie ratings are indicated by the symbol "🔒".

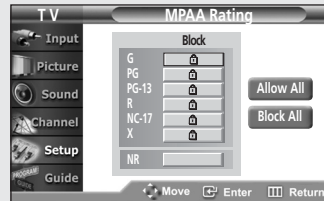

Press the **▲/▼/◀▶** buttons and the **ENTER** button to activate the appropriate restrictions for movie rating system.

Press the **EXIT** button to exit.

- ◀ Allow All : Press to unlock all movie ratings.
- Block All : Press to lock all movie ratings.

Important Notes About Parental Locks

Explanation of the MPAA and TV (FCC) Rating Systems:

TV (FCC) Age-Based Ratings

TV-MA

Mature audiences only. This program may contain mature themes, profane language, graphic violence and explicit sexual content.

TV-14

Parents strongly cautioned. This program may contain sophisticated themes, sexual content, strong language and more intense violence.

TV-PG

Parental guidance suggested. The program may contain infrequent coarse language, limited violence, some suggestive sexual dialogue and situations.

TV-G

General audience. It contains little or no violence, no strong language, and little or no sexual dialogue or situations.

TV-Y7

Directed to older children. Themes and elements in this program may include mild physical or comedic violence, or may frighten children under the age of seven.

TV-Y

All children. The themes and elements in this program are specifically designed for a very young audience, including children from ages two – six.

TV (FCC) Content Category

V	Fantasy violence
S	Sexually Suggestive Dialog
L	Adult Language
D	Sexual situation
FV	Violence

MPAA Rating System (Movies)

G	General audience (no restriction).
PG	Parental guidance suggested.
PG-13	PG-13 (Parents strongly cautioned).
R	R (Restricted. Children under 17 should be accompanied by an adult).
NC-17	No children under age 17.
X	X (Adults only).
NR	Not rated.

- TV (FCC) ratings: The particular rating that you have selected will be locked (and indicated as a red “L” on a blue background). Also, all of the age-based ratings will be locked within the particular group (i.e., “group 1” or “group 2”).
Suppose that the TV-G rating and all of its contents (V, S, L, and D) are locked. In that case, more restrictive ratings (TV-PG, TV-14, and TV-MA) and all of their contents (V, S, L, and D) are automatically locked as well.
- MPAA ratings: The particular rating that you have selected will be locked. In addition, more restrictive ratings will be locked as well.
- Neither TV (FCC) ratings nor MPAA ratings apply to news programs.

Viewing Closed Captions

Analog

Setting Up Analog Captions (On-Screen Text Messages)

The Analog Caption function operates in either analog RF channel mode or external signal mode. (Depending on the broadcasting signal, the Analog Caption function may operate on digital channels.)

1

Press the **MENU** button.

Press the **▲** or **▼** button to select "Setup", then press the **ENTER** button.



2

Press the **▲** or **▼** button to select "Caption", then press the **ENTER** button.

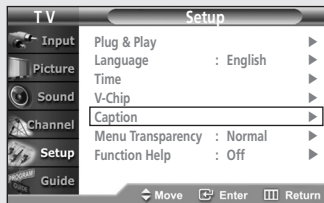

3

Press the **ENTER** button. Press the **▲** or **▼** button to select "On", then press the **ENTER** button.

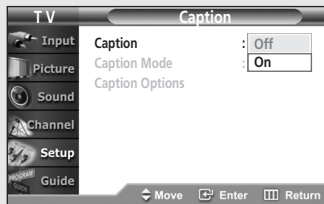

4

Press the **▲** or **▼** button to select "Caption Mode", then press the **ENTER** button. Press the **▲** or **▼** button to select the sub-menu (CC1, CC2, CC3, CC4, TEXT1, TEXT2, TEXT3 or TEXT4) you want.

Press the **EXIT** button to exit.

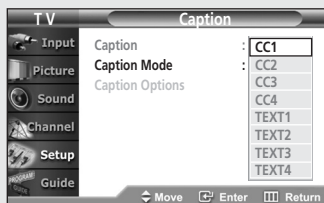

Alternate method:

Simply press the **CAPTION** button on the remote control to select caption "On".



◀ Notes

- The Caption feature doesn't work in HDMI mode.
- The availability of captions depends on the program being broadcast.

Digital**Setting Up Digital Captions (On-Screen Text Messages)**

The Digital Captions function operates on digital channels.

1

Press the **MENU** button.

Press the **▲** or **▼** button to select "Setup", then press the **ENTER** button.

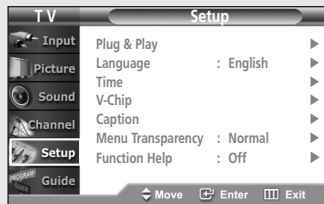
**2**

Press the **▲** or **▼** button to select "Caption", then press the **ENTER** button.

**3**

Press the **ENTER** button.

Press the **▲** or **▼** button to select "On", then press the **ENTER** button.

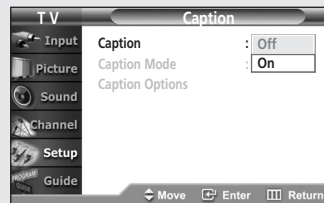
**4**

Press the **▲** or **▼** button to select "Caption Options", then press the **ENTER** button.

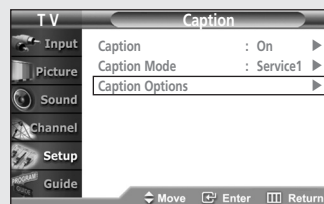

◀ Notes

Only when Caption Mode is in Service1-Service6, you can use Caption Options.

5

Press the ▲ or ▼ button to select the option (Service, Size, Style, Foreground or Background) you want. Press the ENTER button. Press the ▲ or ▼ button to select the desired setting, then press the ENTER button.

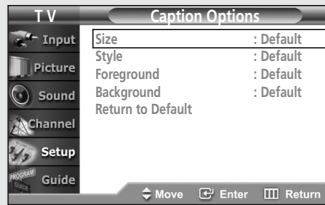
**Size :**

This option consists of Default, Small, Standard, Large. The default is Standard.

Style:

This option consists of Default, Style0 ~ Style 7. You can change the font you want. The default is Style 0.

Foreground:

This option consists of Default, White, Black, Red, Green, Blue, Yellow, Magenta, Cyan. You can change the color of the letter. The default is White.

Background:

This option consists of Default, White, Black, Red, Green, Blue, Yellow, Magenta, Cyan. You can change the background color of the caption. The default is Black.

Return to Default :

This option sets each of Service, Size, Style, Foreground, Background to its default.

Notes:

- The availability of captions depends on the program being broadcast.
- For other channels, which don't operate with the Digital Captions feature, each press of the CAPTION button will alternate among CC1, CC2, CC3, CC4 and OFF.
 - *CC1; The Primary Synchronous Caption Service. These are captions in the primary language that must be in sync with the sound, preferably matched to a specific frame.
 - *CC2; The Special Non-Synchronous Use Captions. This channel carries data that is intended to augment information carried in the program.
 - *CC3; Secondary Synchronous Caption Service. Alternate program-related caption data, typically second language captions.
 - *CC4; Special Non-Synchronous Use Captions. Similar to CC2.

Menu Transparency Level

Adjusts the transparency of the menu screen.

1

Press the **MENU** button.

Press the **▲** or **▼** button to select "Setup", then press the **ENTER** button.



2

Press the **▲** or **▼** button to select "Menu Transparency", then press the **ENTER** button.

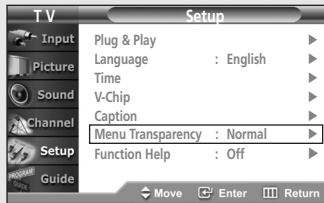

3

Press the **▲** or **▼** button to select level, then press the **ENTER** button.

Press the **EXIT** button to exit.

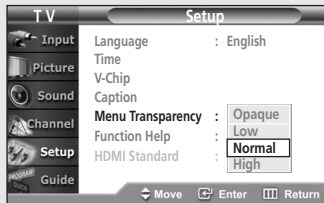

Setting the Function Help

Displays help on the menu functions.

1

Press the **MENU** button.

Press the **▲** or **▼** button to select "Setup", then press the **ENTER** button.



2

Press the **▲** or **▼** button to select "Function Help", then press the **ENTER** button.

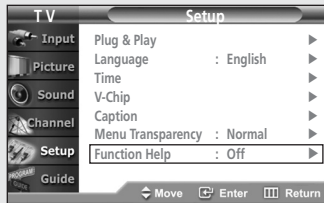

3

Press the **▲** or **▼** button to select "On", then press the **ENTER** button

Press the **EXIT** button to exit.



Digital Electronic Program Guide

Your TV has an “Electronic Program Guide” to help you navigate through all the possible viewing options. The EPG supplies information, such as program lists, start and end times of all available channels.

In addition, detailed information about the program is often available in the EPG. (The availability and the amount of program details will vary depending on the broadcaster.)

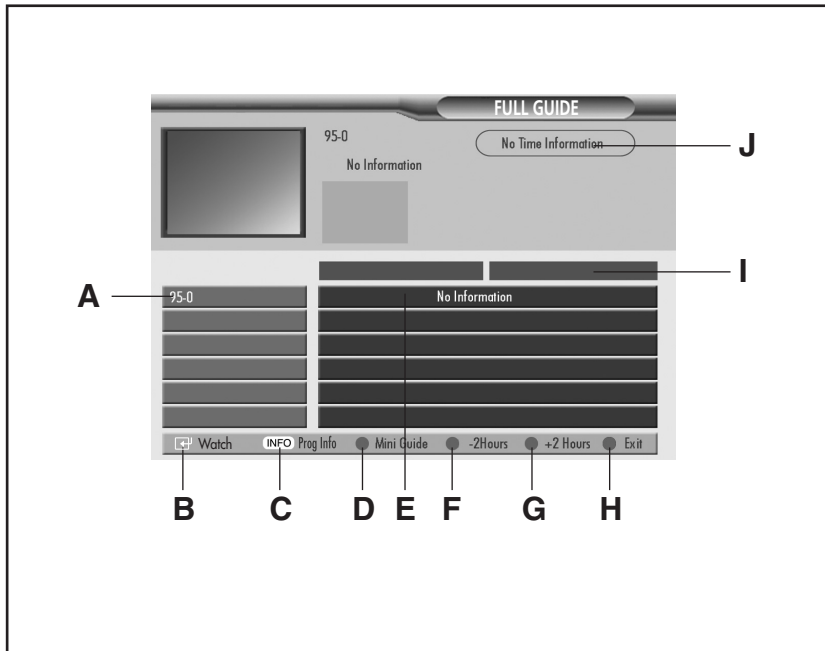

Viewing the Electronic Program Guide

SPECIAL FEATURES

- | | |
|--|---|
| <p>A Displays which channel is currently selected to show program information in the Channel Guide.</p> <p>B Displays Watch Icon in the full guide mode when program time is current. The Remind Icon appears once you have selected a program with the ENTER button to view in the future. Del Remind appears to let you know the program can be deselected with the ENTER button.</p> <p>C Press to view detailed information for the selected digital program.</p> <p>D Switches to the mini program guide. The mini guide shows the titles of the available programs of one channel. Press the Red button on the remote control. The set default guide is Mini Guide.</p> <p>E Displays titles and other details about upcoming programs of particular channels. Highlight the program and press INFO. to see additional and</p> | <p>detailed information. (The availability of additional details depends on the broadcaster.) Use the Menu ▲, ▼ buttons to search information about another channel.</p> <p>F Scrolls backwards quickly (2 hours). Press the Green button on the remote control.</p> <p>G Scrolls forward quickly (2 hours). Press the Yellow button on the remote control and repeatedly press ENTER until the appropriate time is displayed.</p> <p>H Exits from the Program Guide and returns to normal viewing mode. Press the Blue button on the remote control.</p> <p>I Displays the program times (arranged in 1 hour time blocks)</p> <p>J Displays the current time and date.</p> |
|--|---|

Notes:

- You can use the **GUIDE** button on the remote control to display the Electronic Program Guide. The EPG begins its list with the channel that is currently active.
- The EPG will only work when you are receiving digital channels.
- Depending on the broadcast information, the Guide time and actual program time may not match. This is not a fault of the TV.
- The Guide may not always display program information.

Using the Electronic Program Guide

1

Press the **MENU** button.

Press the **▲** or **▼** button to select "Guide", then press the **ENTER** button.

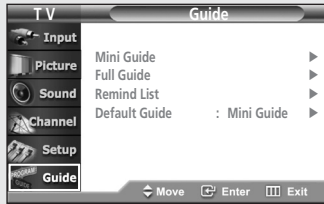

2

Press the **▲** or **▼** button to select "Default Guide", then press the **ENTER** button.

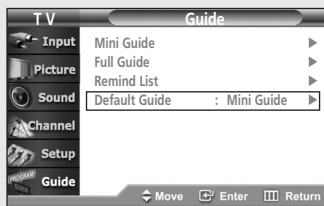

3

Press the **▲** or **▼** button to select "Mini Guide" or "Full Guide", then press the **ENTER** button.

Press the **EXIT** button to exit.

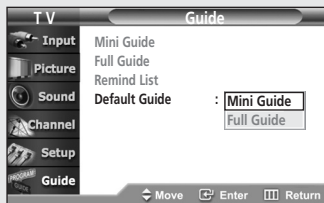

- Mini Guide : Displays the guide for one channel.
- Full Guide : Displays the guide for all channels.

Viewing Information about a Single Channel

1

Press the **MENU** button.

Press the **▲** or **▼** button to select "Guide", then press the **ENTER** button.

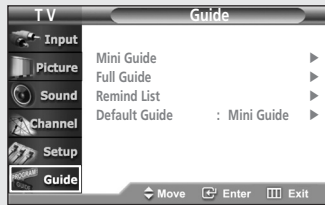

2

Press the **▲** or **▼** button to select "Mini Guide", then press the **ENTER** button.

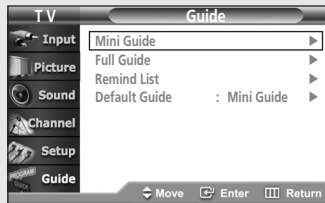

3

Press the **▲** and **▼** buttons to view information about one channel by time.

You can switch between Full Guide mode and Mini Guide mode by pressing the **Red** button repeatedly.

Select the program you want by pressing the **▲** and **▼** buttons and press the **INFO** button on the remote control.

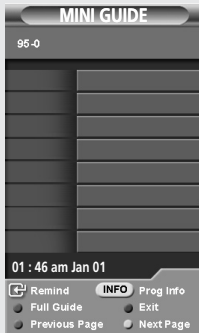

4

Press the **Blue** button or **EXIT** button to exit.

◀ **ENTER** button:

Press the ENTER button to watch the selected channel.

Red button:

Press the Red button to switch to the program guide for all channels. Press the Red button again to switch to the program information for the selected channel.

Blue button:

Press the Blue button to exit.

Green button:

Press the Green button to move to the previous page.

Yellow button:

Press the Yellow button to move to the next page.

INFO button:

Press to view detailed information for the selected digital program.

Notes:

- You can also view information about a single channel by pressing the GUIDE button on the remote control. (The EPG should be pre-set in Mini Guide mode.)
- Press the INFO button on the remote control to view the program information for the current channel.
- However, this function is available only when the default program guide setting has been set to "Mini Guide".
- The full or mini guide will disappear automatically if no function buttons on the front panel or remote control are pressed for 2 minutes. (If you want to exit full or mini guide after the set receives broadcasting information, please wait 2 minutes or power on/off .)

Viewing Information about Channels

Displays the program time and content for all channels. This function is available only when the program is digital.

1
Press the **MENU** button.

Press the **▲** or **▼** button to select "Guide", then press the **ENTER** button.



The image shows a TV screen with a menu titled "TV Guide". On the left side, there are menu items: "Input", "Picture", "Sound", "Channel", "Setup", and "Guide". The "Guide" item is highlighted. On the right side, there are sub-menu items: "Mini Guide", "Full Guide", "Remind List", and "Default Guide". The "Full Guide" item is highlighted. At the bottom of the screen, there are navigation buttons: "Move", "Enter", and "Exit".

2
Press the **▲** or **▼** button to select "Full Guide", then press the **ENTER** button.



The image shows the same TV screen as in step 1, but now the "Full Guide" item is highlighted. The "Enter" button at the bottom is now labeled "Return".

3
Press the **Green** button to activate "-2 Hours" and the **Yellow** button to activate "+2 Hours".

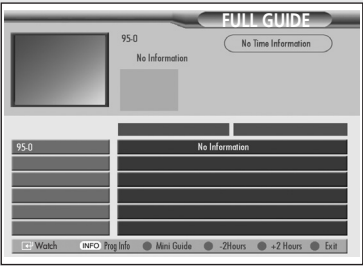

The image shows a screen titled "FULL GUIDE". At the top, it says "95-0" and "No Information". Below this, there is a grid of program information. The first row shows "95-0" and "No Information". At the bottom of the screen, there are navigation buttons: "Watch", "INFO", "Prog Info", "Mini Guide", "2Hours", "+2 Hours", and "Exit".

4
You may now:

- Jump to a channel directly: Use the **▲** and **▼** buttons to highlight the program in the **▶** column and press **ENTER**.
- Obtain additional program details: Highlight the title of a program using the **▲/▼/◀/▶** buttons and press the **INFO** button.
- Exit from the Program Guide and return to normal viewing mode: Press Blue button or the **EXIT** button.

Notes:

- Displays the program times in two hour segments.
- Displays the current date and time on the top right of the screen.
- The current time displayed on the program information is subject to the time information sent from the broadcasting station, so it may differ from the actual time.
- Press the **GUIDE** button on the remote control to view the program information for all channels. However, this function is available only when the default program guide setting is set to "Full Guide".

◀ **INFO button:**
Displays detailed information for the selected digital program.

▲/▼ button:
Displays program information for each channel, based on the time. Select your desired program using the Up/Down button, and then press the **ENTER** button to view the program information for the selected program.

Red button:
Each press of the Red button switches between program information for one channel and all channels.

Green button:
Press the Green button to view the program information from two hours ago.

Yellow button:
Press the Yellow button to view the program information for two hours from now.

Blue button:
Press the Blue button to exit.

Remind List

Reminded Viewing List

If you have made a scheduled viewing list of programs you would like to see, the channel will be automatically switched to the scheduled program at the scheduled time even if you are watching another program.

1

Press the **MENU** button.

Press the **▲** or **▼** button to select "Guide", then press the **ENTER** button.

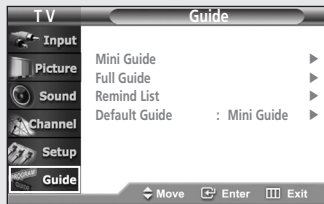

2

Press the **▲** or **▼** button to select "Mini Guide", then press the **ENTER** button.

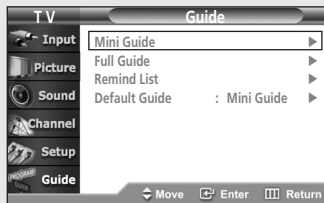

3

Press the **▲** or **▼** button to select programs you would like to see, then press the **ENTER** button. The symbol "✓" will be displayed.

Each press of the **ENTER** button will switch between "Reminded" and "Clear".

Press the **EXIT** button to exit.

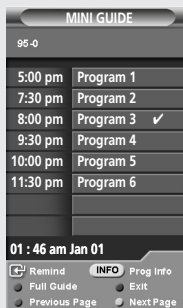

To view the Remind List

1

First, select the channel you want to add to your list. Press the **MENU** button.

Press the ▲ or ▼ button to select "Guide" then press the **ENTER** button.

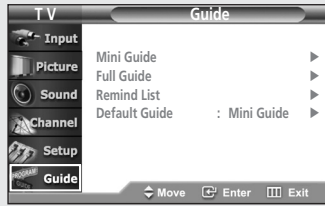

2

Press the ▲ or ▼ button to select "Remind List", then press the **ENTER** button.

To remove all the scheduled programs

Press the ► button to select "Cancel All", then press the **ENTER** button.

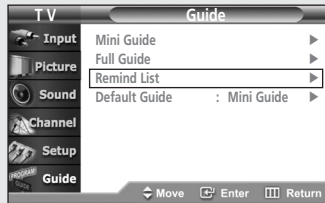

Customizing Your Remote Control

Your TV comes equipped with a universal remote control. In addition to controlling the TV, the universal remote control can also operate a Set-Top Box, VCR, Cable box and DVD (even if your VCR, Cable box and DVD are made by manufacturers other than Samsung).

- The remote control might not be compatible with all VCRs, DVD players and Cable boxes.

Setting Up Your Remote Control to Operate Your VCR (Cable box or DVD player)

1

Turn off your VCR (Cable box or DVD player).

2

Press the **MODE** button and make sure that the **VCR (CABLE or DVD)** LED is illuminated.

◀ The remote control has five modes: **TV**, **STB**, **VCR**, **CABLE** and **DVD**.

3

On your Samsung remote control, press the **SET** button.

4

Enter 3 digits of the VCR (Cable box or DVD player) code listed on next page for your brand of VCR (Cable box or DVD player).

◀ Make sure you enter 3 digits of the code, even if the first digit is a "0". (If more than one code listed, try the first one.)

5

Press the **POWER** button on the remote control. Your VCR (Cable box or DVD player) should turn on. If your VCR (Cable box or DVD player) turns on, your remote control is now set correctly.

◀ If your VCR (Cable box or DVD player) does not turn on, repeat steps 2, 3, and 4, but try one of the other codes listed for the brand of your particular VCR (Cable box or DVD player).

6

Once your remote control is set up, press the **MODE** button any time you want to use the remote to operate your VCR (Cable box or DVD player).

- When your remote is in the **TV** mode, the VCR (or DVD player) control buttons (**REW**, **STOP**, **PLAY/PAUSE** and **FF**) will still operate your VCR (or DVD player).
- When your remote control is in the **VCR (CABLE or DVD)** mode, the volume buttons still control your TV's volume

SPECIAL FEATURES

Remote Control Codes

VCR Codes

000	Samsung	018	Candle, Citizen, Emerson, LG(Goldstar), Radio Shack, Realistic, Sears, Toshiko, Teknika, Totevision	036	Electrohome, Emerson, Radio Shack, Realistic, Sharp	059	Pioneer					
001	LG(Goldstar)			019	037	RCA	060	JC Penney				
002					Daewoo	021	038	Magnavox, Marantz, Philco, Philips, Sylvania	061	Candle, Citizen, Portland		
003	022	Audio Dynamics, Candle, Citizen, Daewoo, Emerson, Samsung, Scott, Toshiba	039	JC Penney, JCL, Kenwood, Marantz, NEC, Tatung, Teac			062	Canon, Curtis Mathes, General Electric, JC Penney, Magnavox, Panasonic, Philco, Radio Shack, Realistic, Sylvania				
004			023	Calortyme, Curtis Mathes, DB, LG(Goldstar), Harman Kardon, JC Penney, JCL, Kenwood, Marantz, NEC			040	Logik, Multitech, Shintom	063	RCA		
005							024	Aiwai, Curtis Mathes, Dynatech, Emerson, Funai, Hitachi, Lloyd, LXI, MTC, Multitech, Radio Shack, Realistic, Signature, Sylvania, Symphonic, Tandy, Teac, Teknika	041	General Electric, Multitech, Samsung	064	Shintom
006									025	Audio Dynamics, DB, JC Penney, JCL, Kenwood, Marantz, NEC, Pioneer, Sansui	042	Pioneer
007	Daewoo, LG(Goldstar)	043	Emerson	066	Emerson							
008	Daewoo	044	Hitachi, JC Penney, Pentax, RCA, Sears	067	Fisher							
009	Curtis Mathes, Dimensia, General Electric, PROSCAN, RCA	045	Hitachi	069	LG(Goldstar)							
011	Bell & Howell, Fisher, JC Penney, JCL, Kenwood, Marantz, NEC, Quartz, Radio Shack, Realistic, Sanyo, Sears, Tandy	046	RCA	070	Marantz, NEC							
014	Hitachi, JC Penney, Pentax, Pioneer, RCA, Sears, Toshiba	047	Sony	071	Emerson							
015	Admiral, Optimus, Radio Shack, Realistic, Sharp	048	Sharp	073	Curtis Mathes, NEC							
016	Candle, Citizen, Craig, Curtis Mathes, General Electric, Go Video, JC Penney, MTC, Multitech, RCA, Samsung, Totevision	050	Emerson, Scott	074	Emerson							
017	Canon, Curtis Mathes, Emerson, General Electric, Instant Replay, JC Penney, JCL, Magnavox, Marantz, Panasonic, Philco, Philips, Quasar, Radio Shack, Realistic, RCA, Sylvania, Technics, Teknika	051	Emerson, Samsung	076	Curtis Mathes, Emerson, TMK							
		052	Fisher, Radio Shack, Realistic, Sears	077	Emerson, Scott							
		026	Akai, Shintom, Sony	078	RCA, Teac							
		027	Fisher, Sears	079	Emerson							
		028	Fisher, Radio Shack, Realistic, Sears, Toshiba	082	KLH							
		029	Emerson	084	Panasonic							
		030	Teknika	085	Daewoo							
		031	Akai, Samsung	086	Panasonic							
		032	Akai, Emerson	055	Candle, Citizen, Curtis Mathes, LG(Goldstar), JCL, Kenwood, Marantz, NEC, Pentax Research+	088	Admiral					
		035	Shintom, Sony	056	Emerson							
			057	Fisher, Sears, Toshiba								
			058	Emerson, Scott, Toshiba								

Cable Box Codes

000	Samsung	020	Eastern International, Hamlin, Regal	038	GI, Jerrold	057	Tocom
001	Nawoo			039	Unika	058	
002	TaeYungYang	021	Hamlin, Regal	040	Magnavox, Philips, Unika, Viewstar	059	Universal
003	DeaRyung	022	Zenith	041	Magnavox, Philips, Regency, Viewstar	060	
004	DongKuk	023	GI, Jerrold	042	Hamlin	063	Tocom
005	DaeHan	024	Oak, Osk Sigma	044	GI, Jerrold	065	Zenith
006	LG(Goldstar)	025	Tocom	045	Hitachi, Macom	066	Stargate 2000
007	Saewoo	026	Pioneer	046	Oak	067	Sylvania, Texscan
008	RCA	027	Magnavox, Philips, Viewstar	047	Panasonic	069	Panasonic, Zenith
010	Regency	028	Pioneer	048	Magnavox, Philips, Viewstar	070	Jerrold
011	Hamlin, Panasonic, Regal, Samsung	029	Magnavox, Philips, Tocom, Viewstar	049	Magnavox, Philips, Unika, Viewstar	071	Samsung
012	GI, Hamlin, Jerrold	030	Samsung	050	Zenith	072	
013	GI, Jerrold	031	GI, Jerrold	051	Hitachi, Macom	073	Jerrold
015	Anvision, Cable Star, Eagle, Magnavox, Philips, Randtek, Viewstar	032		052	Pioneer, Samsung, Warner Amex	074	RCA
016	NSC	033		054	General Instrument, Hitachi, Jerrold, Signature, Starcom	075	GI
017		034	Magnavox, Philips, Viewstar	056	Hamlin	076	
019	Sylvania, Texscan	035	RCA, Panasonic, Sprucer	057		077	
		036	Magnavox, Philips, Viewstar				
		037					

DVD Codes

000	Samsung	003	JVC	006	Panasonic	009	Curtis Mathes
001	LG(Goldstar)	004	Sony	007	Philips		
002	Toshiba	005	Sharp	008	PROSCAN, RCA		

Chapter Five

TROUBLESHOOTING

If the TV seems to have a problem, first try this list of possible problems and solutions. If none of these troubleshooting tips apply, then call your nearest service center.

Identifying Problems

Problem	Possible Solution
Poor picture.	Try another channel. Adjust the antenna. Check all wire connections.
Poor sound quality.	Try another channel. Adjust the antenna.
No picture or sound.	Try another channel. Press the TV/VIDEO button. Make sure the TV is plugged in. Check the antenna connections. Make sure the MUTE button is off.
No color, wrong colors or tints.	Make sure the program is broadcast in color. Adjust the picture settings.
Picture rolls vertically.	Adjust the antenna. Check all wire connections. If you are using a VCR, check the tracking.
The TV operates erratically.	Unplug the TV for 30 seconds, then try operating it again.
Your remote control does not operate your TV.	Press the MODE button to put your remote control in the "TV" mode. Make sure the remote has batteries. Check that the "+" and "-" ends of the batteries are inserted correctly. Check that the batteries are drained.
The TV won't turn on.	Make sure the wall outlet is working. Make sure the TV is plugged in. Make sure the remote has batteries.
Digital broadcasting screen problem	Please check the digital signal strength and input antenna.

Cleaning and Maintaining Your TV

Please follow these guidelines to get the maximum performance from your TV.

Placement

- Do not place the TV near extremely hot, cold, humid or dusty places.
- Do not place the TV near appliances with electric motors that create magnetic fields, such as vacuum cleaners.
- Keep the ventilation openings clear; do not place the TV on a soft surface, such as cloth or paper.
- Place the TV in a vertical position only.

Liquids

- Do not handle liquids near or on the TV. Liquids that spill into it can cause serious damage.

Cabinet

- Never open the cabinet or touch the parts inside.
- Wipe your TV with a clean, dry cloth. Never use water, cleaning fluids, wax, or chemicals.
- Do not put heavy objects on top of the cabinet.

Temperature

- If your TV is suddenly moved from a cold to a warm place, unplug the power cord, and allow at least two hours for moisture that may have formed inside the unit to dry completely.

Using Your TV in Another Country

If you plan to take your TV with you to a foreign country, please be aware of the different television systems that are in use around the world. A TV designed for one system may not work properly with another system due to differences in the TV channel frequencies.

Specifications

Model	TX-R2675WH	TX-R2678WH	TX-R3075WH
Voltage	AC 120V		
Frequency of Operation	60Hz		
Dimensions (mm/inches)	810 x 515 x 535 mm/ 31.9 x 20.3 x 21.1 inches	820 x 497 x 502 mm/ 32.3 x 19.6 x 19.8 inches	898 x 559 x 587 mm/ 35.4 x 22.0 x 23.1 inches
Weight(Kg/lbs)	40.2 Kg/ 88.6 lbs	39.5 Kg / 87.1 lbs	56.0 Kg / 123.5 lbs

APPENDIX