



**SAMSUNG**

# **COLOUR TELEVISION**

**SP434/521/524**

## **Owner's Instructions**

Before operating the unit,  
please read this manual thoroughly,  
and retain it for future reference.

**REMOTE CONTROL  
MENU CONTROL  
PICTURE IN PICTURE (OPTION)  
TELETEXT FUNCTION**

## Feature

ENG

 *The number on this symbol represents the reference page.*

### 15 Mutual responsive dialogic picture

By adopting dialogic method (if you select one menu, another picture is displayed) everybody can easily execute the next operation and verify optional conditions.

### 15 One method makes every operation easy

By identifying operating methods of the remote control, if you learn one method, you can learn another method naturally.

### 23~26 Various pictures and sound functions

With various pictures and sound functions, you can adjust the condition of picture and sound to your taste.

- You can select one of five picture modes (Custom, Standard, Dynamic, Movie, Mild) you want to view.
- You can select one of five sound modes (Custom, Standard, Music, Movie, Speech) you want to hear.

### 27~28 Time saving function

You can use this TV set with the function of automatic turning on or off to the time you set.

### 29 Extra Function

You can easily adjust the menu. They are as follows;

- Language
- Blue screen
- Noise Reducer
- Low noise AMP
- Demonstration

### 30~31 Picture in Picture (PIP) Operation

With this advanced digital feature, you can use your VCR to enjoy a movie while still keeping up with the latest news. You actually see two sources at the same time: one on the main screen, the other inset on a subscreen.

Main and subscreen images may be interchanged instantly, and the subscreen image can be shifted to any position of the main screen by remote control.

## Caution

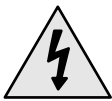

**CAUTION**  
RISK OF ELECTRIC SHOCK  
DO NOT OPEN



**CAUTION:** TO PREVENT ELECTRICAL SHOCK, DO NOT REMOVE REAR COVER. NO USER SERVICEABLE PARTS INSIDE. REFER SERVICING TO QUALIFIED SERVICE PERSONNEL.

The lightning flash and arrow head within the triangle is a warning sign alerting you of "dangerous voltage" inside the product.



The exclamation point within the triangle is a warning sign alerting you of important instructions accompanying the product.



**WARNING:** TO PREVENT DAMAGE WHICH MAY RESULT IN FIRE OR SHOCK HAZARD, DO NOT EXPOSE YOUR TELEVISION TO RAIN OR MOISTURE.

 *The main voltage is indicated on the rear of the TV set and the frequency is 50Hz or 60Hz.*



*You have just purchased  
a SAMSUNG television.*

*Please take the time to read these instructions,  
as they will enable you to set up your  
television easily.*

## Contents

◆	CONNECTING AND PREPARING YOUR TELEVISION	
■	Feature.....	2
■	Caution.....	2
■	Safety Instructions.....	4
■	Inserting the Batteries in the Remote Control .....	5
■	Connecting the Aerial (or Cable Television Network) .....	5
■	How to Use this Manual .....	6
■	Quick reference guide for your TV set .....	6
■	Antenna Connections.....	7
■	Video Connections .....	8
■	S-VIDEO Connections .....	10
■	Camcorder Connections .....	12
■	Audio Connections .....	12
■	Front Control .....	13
■	AV Connection .....	13
■	Remote Controls .....	14
■	Switching your Television On and Off .....	15
■	Remote Control.....	15
◆	USING YOUR TELEVISION	
■	Tuning Procedure (Auto store).....	16
■	Tuning Procedure (Manual store) .....	18
■	Tuning Procedure (Channel skip) .....	20
■	Tuning Procedure (Fine tune) .....	21
■	Tuning Procedure (Sort).....	22
■	Picture Adjustment .....	23
■	Picture Menu Adjustment.....	24
■	Sound Adjustment.....	25
■	Sound Adjustment (Surround).....	26
■	Stereo Mode Functions.....	26
■	Setting the Timer.....	27
■	Setting the Clock.....	27
■	Setting the On/Off Timer .....	28
■	Extra Functions .....	29
■	Picture in Picture (Option) .....	30
■	Convergence Adjustment.....	32
■	Teletext Operation (Option) .....	33
◆	RECOMMENDATIONS FOR USE	
■	Specification.....	36
■	Trouble Shooting.....	38
■	Cleaning the TV .....	38

### Symbols



Press



Push



Important



Note

## Safety Instructions

ENG

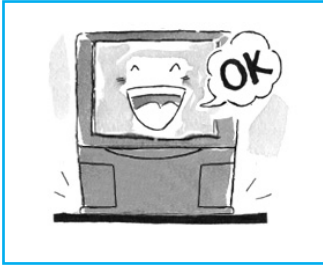

*Place this TV on a stable stand or table.*

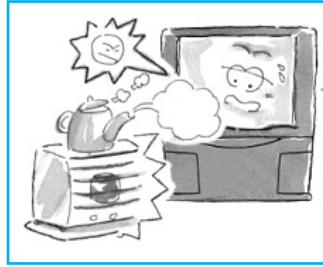

*Avoid exposing the TV set to direct sunlight and other sources of heat.*

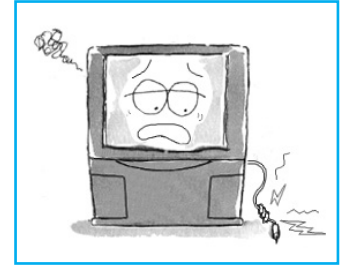

*Do not step on or twist the power cord.*

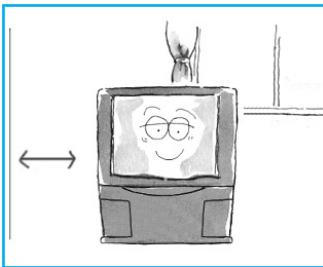

*Adequate ventilation is essential to prevent failure of electrical components.*

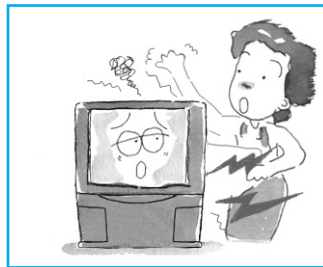

*Do not attempt to disassemble this TV set yourself.*

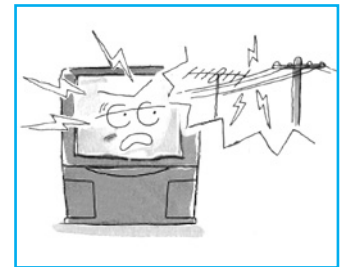

*Do not overload wall outlets or extension cords as this can result in a risk of fire or electric shock.*

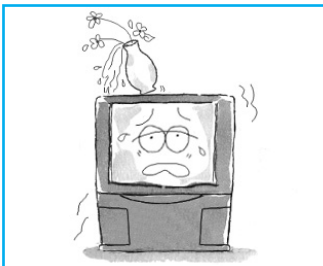

*Never put objects of any kind into the TV set, and do not place a water-containing vessel on the set.*

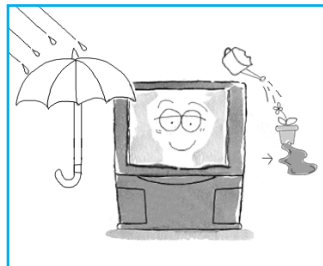

*To prevent damage which may result in fire or shock hazard, do not expose this TV set to rain or excessive moisture.*

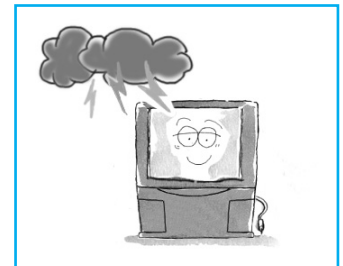

*If it is not being used for a long time or if there is a lightning storm, unplug the TV set.*

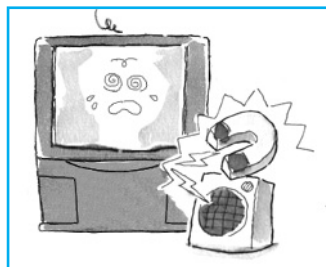

*Keep the vacuum cleaner, etc. away from the TV as far as possible.*

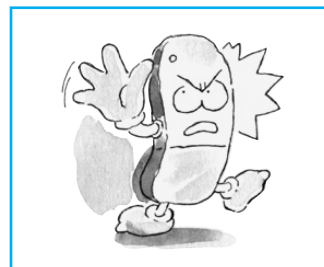

*Avoid dropping the remote control.*

## Inserting the Batteries in the Remote Control

You must insert or replace the batteries in the remote control when you :

- ◆ Purchase the television.
- ◆ Find that the remote control is no longer operating correctly.

- 1 Remove the cover on the underside of the remote control by sliding it off with your thumb.
- 2 Insert two AAA or equivalent batteries placing the “-” end of the batteries against the springs in the remote control.
- 3 Replace the cover by aligning it with the remote control and sliding it until it clicks into place.

- If the remote control is not operating, check the list below.
1. Check the polarity of the batteries.
  2. Check if the batteries are weak.
  3. Check for interruption of electric power.
  4. Check if the power plug is connected to the electrical outlet of the television set.

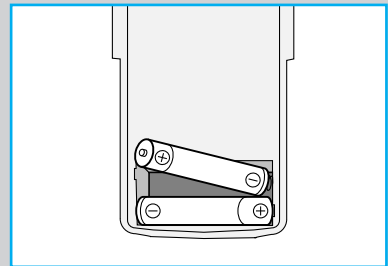
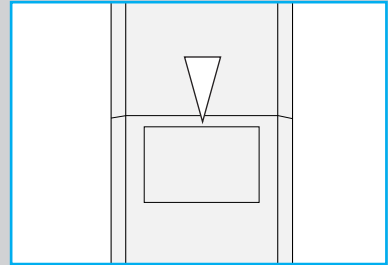

## Connecting the Aerial (or Cable Television Network)

To view television channels correctly, a signal must be received by the set from one of the following sources:

- ◆ An outdoor aerial
- ◆ An indoor aerial
- ◆ A cable television network

- 1 Plug the aerial or cable network input cable into the socket at the bottom of the television's rear panel.
- 2 If you are using an indoor aerial, insert the bottom of the aerial into the support bracket on the top of the television.

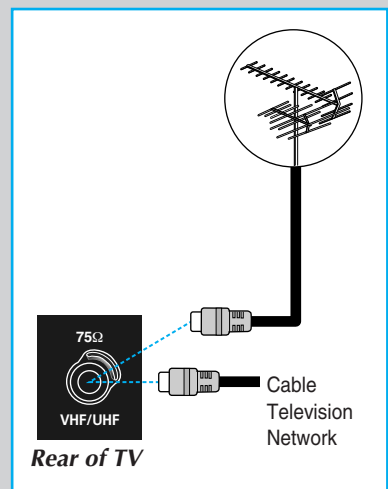

## How to Use this Manual

ENG

- 1 Check the Model Number of your TV set; the Model Number is shown on the rear cover name plate on the set. Use the table below to confirm which features your particular Model is equipped with. This will help you to know which sections of the manual apply to your set.
- 2 Check the Part Number on the rear of your Remote Control handpiece, and note the functions available, as shown on the following pages.

## Quick reference guide for your TV set

*Please check the model number of your TV set.  
This Manual applies to several Models and there are slight differences among them.*

*Please check the table below to see what your TV is equipped with before you begin using these Operating Instructions. Instructions are given for all functions, please disregard those which do not apply to your TV.*

MODEL NAME		TTX	STEREO	
109cm	132cm		NICAM	A2
SP434JMF	SP521/524JMF	○	○	○
SP434PTR	SP521/524PTR	○	○	○

➤ Function available refer to:

TELETEXT **33~35**

STEREO **26**

PIP **30~31**

# Antenna Connections

## Outdoor Antenna Connections

VHF/UHF Antenna

Method 1

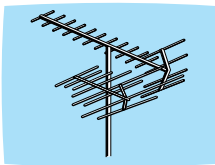

Round 75-ohm coaxial cable

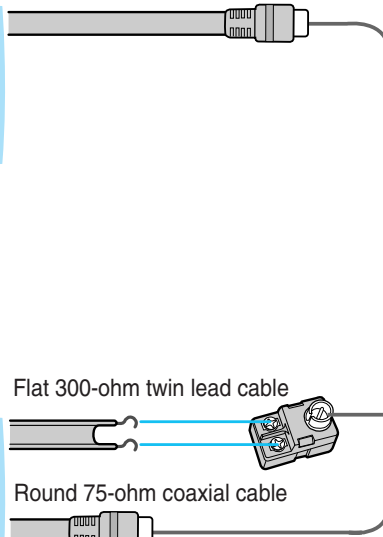

VHF Antenna

Method 2

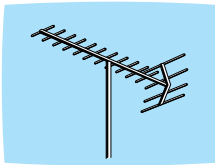

Flat 300-ohm twin lead cable

Round 75-ohm coaxial cable

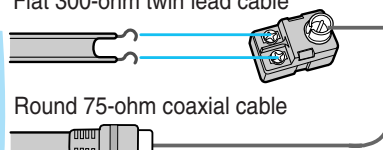

# Video Connections

ENG

## Rear of TV (Option)

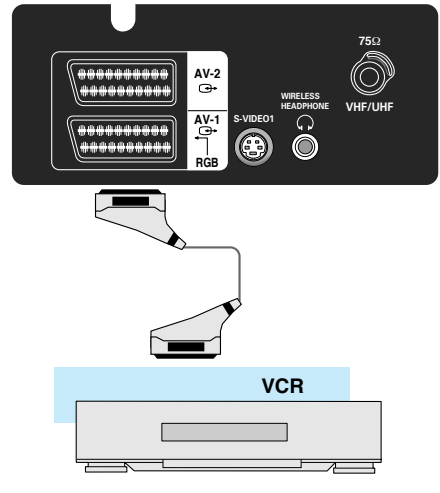
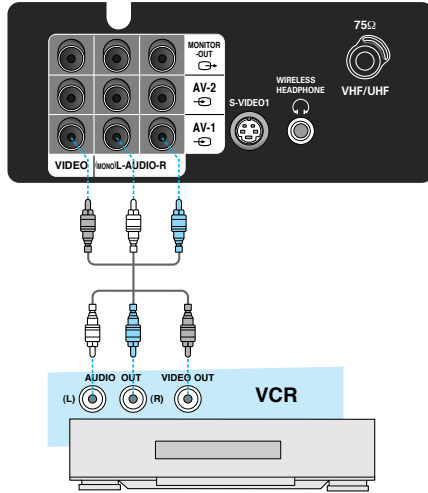

## Side of TV (SP434/SP524)

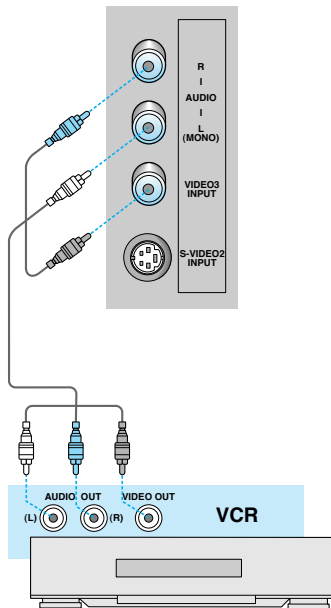

## Front of TV (SP521)

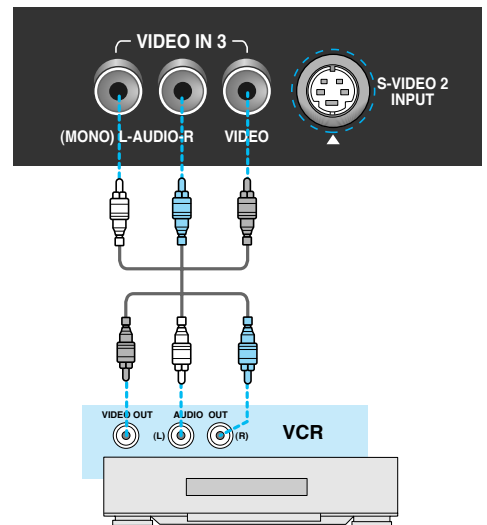



## Video Connections (cont.)

- 1 Connect an optional AUDIO/VIDEO cable from the VIDEO OUT jack on the rear of the VCR to the VIDEO IN jack on the rear of the TV.
- 2 Connect another optional audio/video cable from the AUDIO OUT jacks on the rear of the VCR to the AUDIO IN jacks on the rear of the TV.

◆ If you have a VCR with 21 pin scart jack, connect scart cable to the rear of TV (Option).

- 3 Press the TV/VIDEO button to select "AV".

◆ As you press the button, TV, AV1, AV2, AV3, S-VIDEO1, and S-VIDEO2 are repeated alternately.



- 4 Playback a tape in the VCR.  
(See owner's Manual for VCR)

### 🔊 Self Checkup Function

- ◆ When all front and rear jack of this TV are disconnected, the video mode changes as below.

TV → AV3

(When only AV1 Jack is connected)

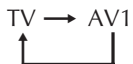

### 🔊 TV/Video Selection

- ◆ Press the TV/VIDEO button repeatedly to select the desired input.
- ◆ Whenever the TV/VIDEO button is pressed, the mode changes as below.

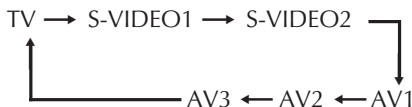

(when all input jacks are connected)

- ◆ When video mode is selected and that AV mode has no input picture signal, the background colour of the TV screen will change to blue regardless of whether the BLUE-SCREEN function is set.
- ◆ Teletext displays on screen will not be output at the Monitor output terminal and Scart output terminal.
- ◆ AV mode isn't selected when VCR wasn't operating, so you must check VCR status before selecting AV mode.

# S-VIDEO Connections

ENG

## Rear of TV (Option)

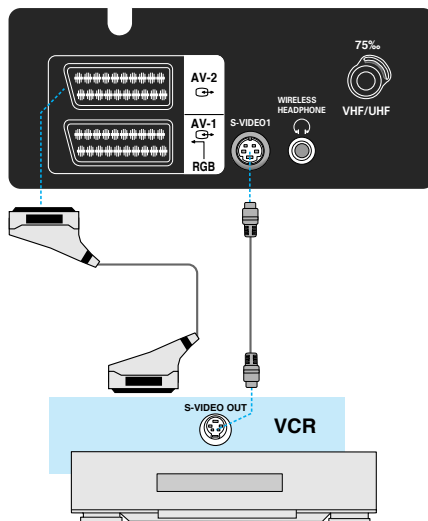
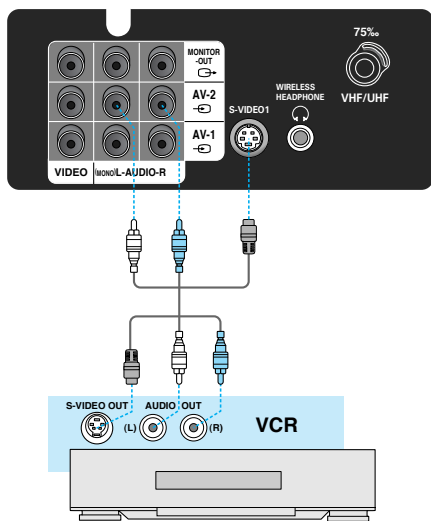

## Side of TV (SP434/SP524)

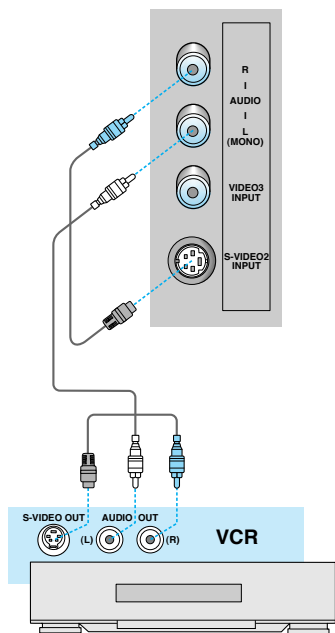

## Front of TV (SP521)

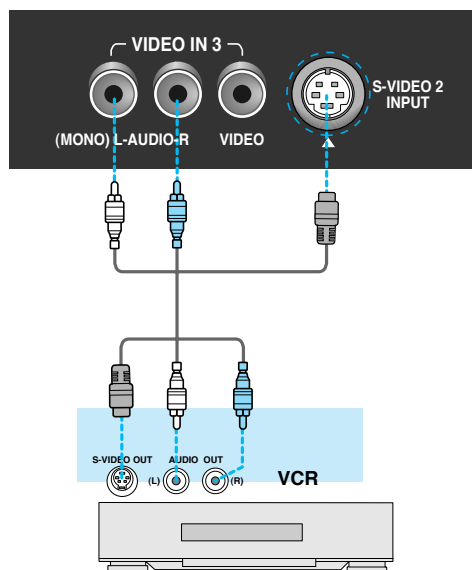

## S-VIDEO Connections (cont.)

---

**1** Connect an optional S-VIDEO cable from the S-VIDEO OUT jack on the rear of the VCR to the S-VIDEO IN jack on the rear of the TV.

---

**2** Connect an optional AUDIO/VIDEO cable from the AUDIO OUT jacks on the rear of the VCR to the AUDIO IN jacks on the rear of the TV.

---

**3** Press the TV/VIDEO button to select "S-VIDEO".

- ◆ As you press the button, TV, S-VIDEO1 and S-VIDEO2 are repeated alternately.



(if all S-VIDEO inputs are connected)

---

**4** Playback a tape in the VCR (See owner's Manual for VCR)

---

- ◆ You can enjoy a more clear and distinct picture if you connect cable to S-VIDEO Jack in case of playing high quality Video.
- ◆ For video signal in Colour System SECAM, connect to the video terminal because there is no standard on S-VIDEO terminal.

# Camcorder Connections

ENG

## Side of TV (SP434/SP524)

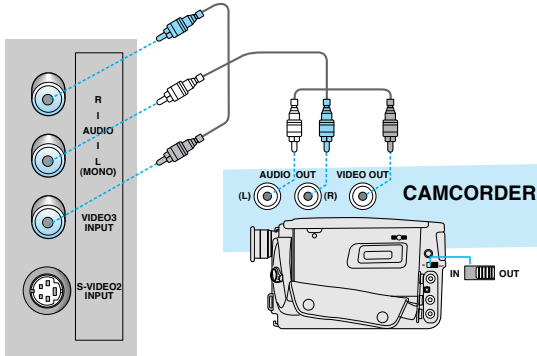

## Front of TV (SP521)

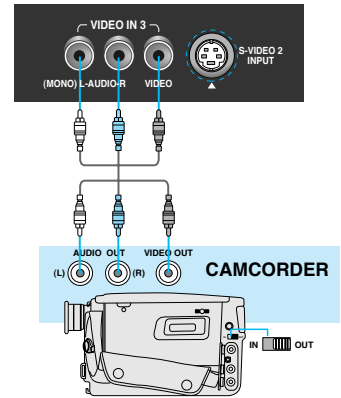

**1** Connect an optional audio/video cable from the VIDEO OUT jack on the camcorder to the VIDEO IN jack on the front of the TV.

**2** Press the TV/VIDEO button to select "AV3".

- ◆ As you press the button TV, AV1, AV2 (S-VIDEO) and AV3 are repeated alternately.

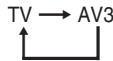

if, only AV3 input was connected.

**3** Slide the VIDEO IN/OUT switch to OUT.

- ◆ Play back a tape in the camcorder. (see owner's manual for camcorder.)

# Audio Connections

## Rear of TV (Option)

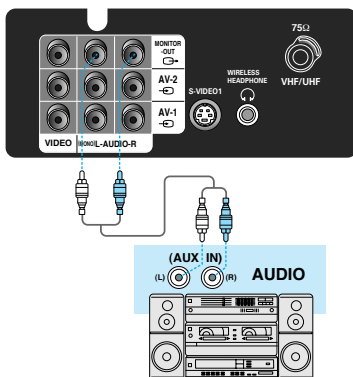

**1** Adjust the volume of the TV to minimum.

**2** Connect an optional audio/video cable from the Audio out jacks on the rear of the TV to the AUDIO IN jacks on the AUDIO.

**3** Position the INPUT SELECTION switch on the audio to AUX and adjust the volume.

- ◆ You can hear a more vivid stereo sound through an audio system.
- ◆ It may be convenient for you, if you connect together the jacks using the following colour code. (Video: Yellow, Audio(left): White, Audio(right): Red)

# Front Control

## SP434/SP524

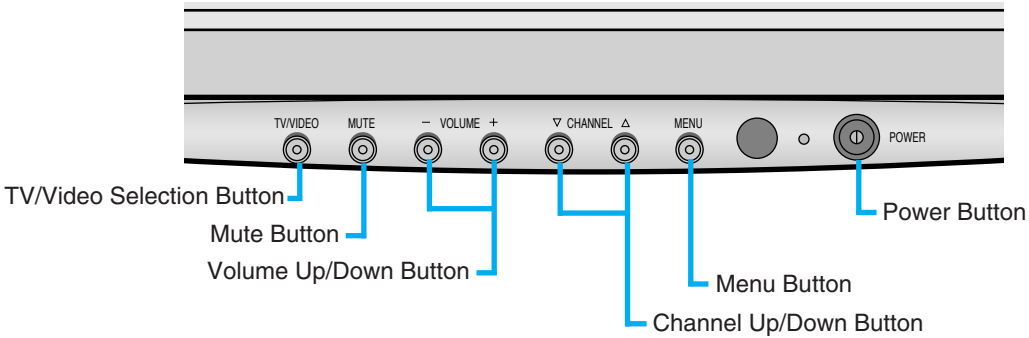

## SP521

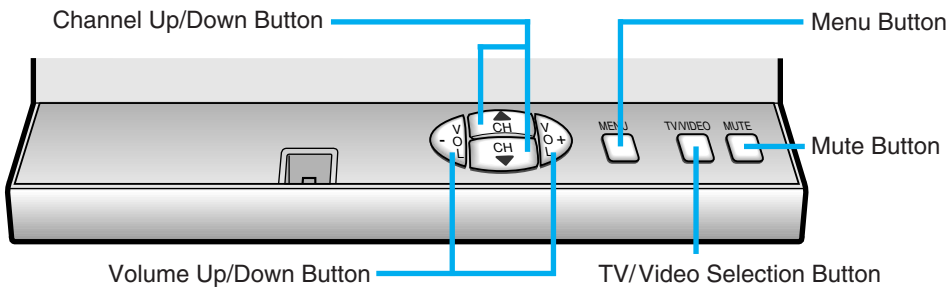

# AV Connection

## Side of TV (SP434/SP524)

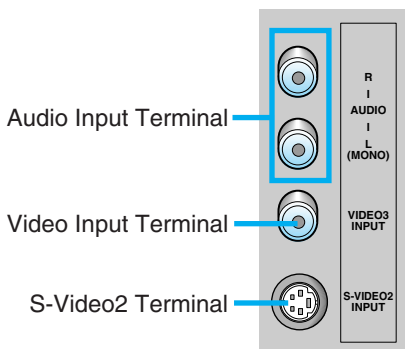

## Front of TV (SP521)

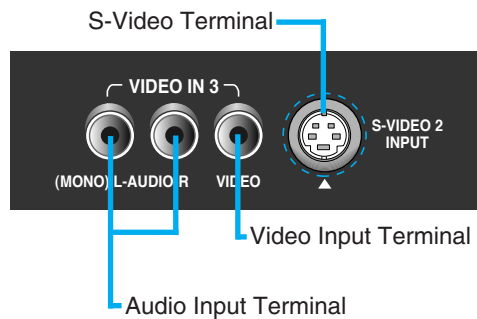

# Remote Controls

ENG

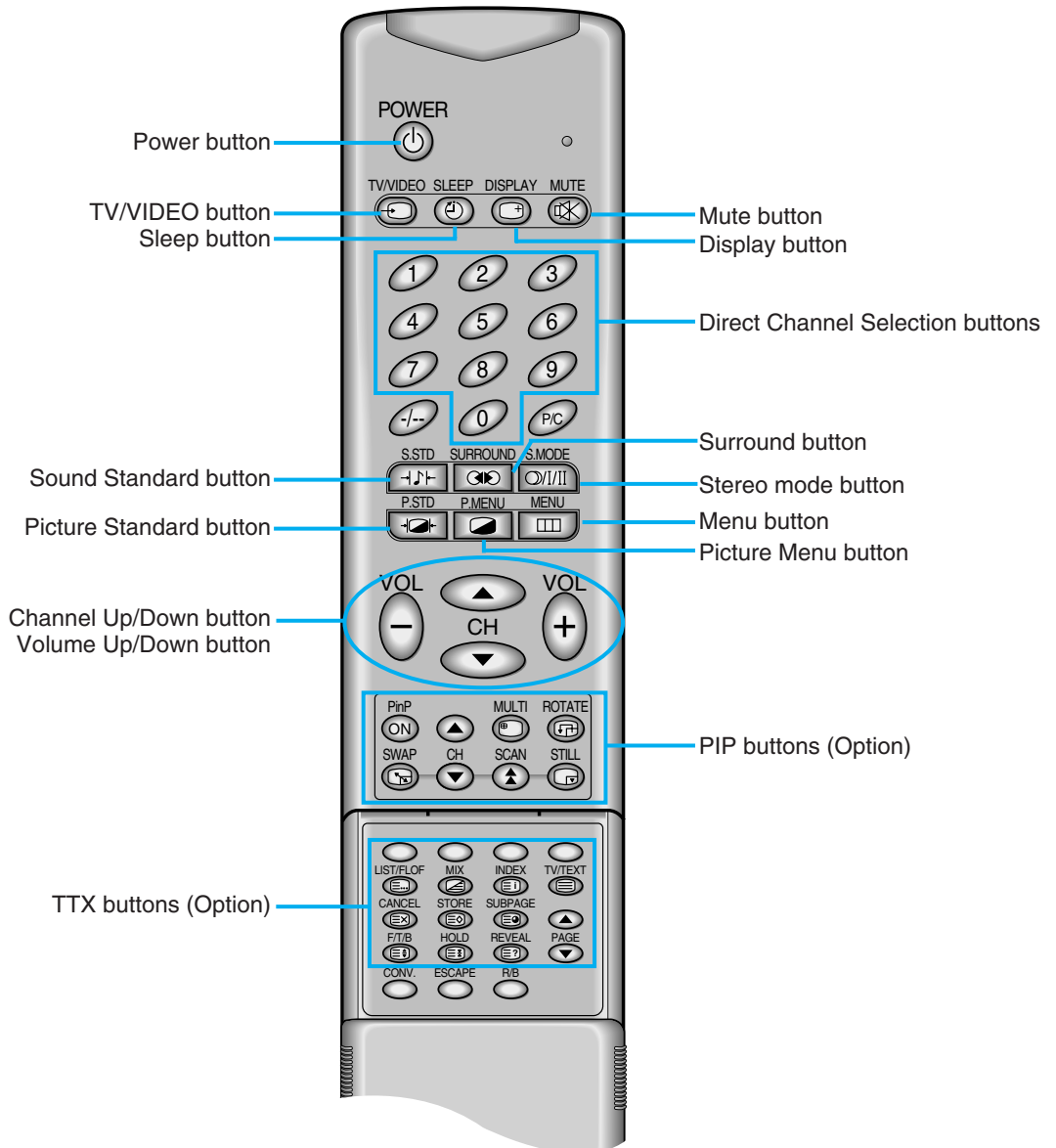

- The Control Range of Transmitter.
  - ◆ You can control the TV set remotely with this transmitter anywhere up to 7~10 meters away from the TV set with in the range of 60°, right and left.
- If a special fluorescent lamp or neon sign lies "POWER ON" around a TV set, a remote control may not operate properly.

## Switching your Television On and Off

- 1 Plug the mains lead into an appropriate wall socket.  
 **The main voltage is indicated on the rear of the TV set and the frequency is 50Hz or 60Hz.**
- 2 Press the POWER button on the front panel to switch the television on.
  - ◆ If you have already stored channels, the channel selected when you last switched your television off appears on the screen.
  - ◆ If you have not yet stored any channels; no clear picture appears. Refer to "Auto store" on page 16, 17 or "Manual store" on page 18, 19.
- 3 Press the POWER button on the front panel to switch the television off.

➤ You can execute every operation by pressing CH▲ or CH▼ buttons and VOL+ or VOL– buttons alternately because of identified operation method, if you learn one method, you can easily operate another function by viewing the picture.

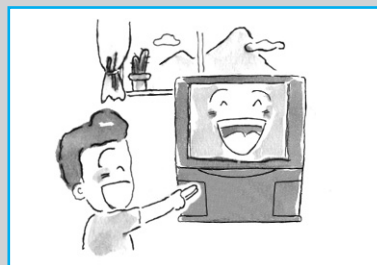

## Remote Control

*Pressing these buttons alternately makes every operation easy.*

Picture change Function Input	Press VOL+ or VOL– buttons to change picture by inputting selected function.
MOVE	Press CH▲ or CH▼ buttons to move your desired Menu.

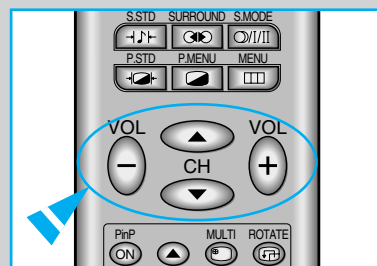

## Tuning Procedure (Auto store)

ENG



Menu   
 Picture   
 Sound   
 Time   
 Setup   
 Function   
 PinP   
 ◆Sel. ±Enter

Setup  
 Auto store   
 Manual store   
 Channel skip   
 Fine tune   
 Sort  
 ◆Sel. ±Enter

Asia/W. Europe   
 CIS/E. Europe   
 China   
 Hongkong/UK   
 Australia   
 NZ/Indonesia   
 South Africa   
 America   
 ◆Sel. ±Set

\* Searching \*   
 P27   
 450MHz   
  
  
  
 50%   
 ◆ ± Exit

*The Auto Store function makes channel storage easier and faster than manual store.*

*This Auto Store can memorise on-air channels from present channels in numerical order.*

- 1 If the TV is in stand-by mode (red light on), press the "POWER" button on the remote control. Press the "MENU" button and press CH ▲ or CH ▼ button to place on the "Setup" option.
- 2 Press VOL+ or VOL- buttons then the "Setup" menu is displayed and press CH ▲ or CH ▼ buttons to place on the "Auto store" option.
- 3 Press VOL+ or VOL- buttons and press CH ▲ or CH ▼ buttons to place on the area where you live.
  - ☛ If you want start Auto store program number 20, before pressing MENU, select program number 19 by pressing CH▲ or CH▼ buttons or direct channel selection buttons (0~9).
- 4 Press the VOL+ or VOL- buttons.
  - ◆ The Television scans the VHF L, VHF H and UHF frequency bands in turn and stores the available channels:
  - ◆ The progress of the scan is indicated by a horizontal bar & percentage.
  - ◆ The number of the channel currently being searched for and the frequency being scanned are displayed.
  - ◆ When channel broadcasted is memorised, horizontal bar turns yellow.
  - ◆ After every channel broadcasted is memorised, "Sort" menu is displayed.
  - ◆ At this point you can view real picture through Sub picture.
- 5 Press "MENU" button repeatedly until the menus disappear.

### ➤ Programme mode (P)

- ◆ When completing Auto Store, the broadcasting stations in your area have been assigned to position number from P00 to max P99. You can select a channel by entering the position number in this mode.

### Real Channel mode (C)

- ◆ You can select a channel by the assigned number to each air broadcasting station in this mode.

### CATV channel mode (S)

- ◆ You can select a channel by entering the assigned number for each cable channel in this mode.



## Tuning Procedure (Auto store) (cont.)

### Area Select by Country

AREA	TV SYSTEM	COUNTRY
Asia/W. Europe	<b>B/G,H:</b> West European TV Standard	<b>Asia;</b> India, Malaysia, Singapore, Thailand,... etc <b>Middle East Asia;</b> Iran, Iraq, Jordan, Kuwait, Oman, Saudi Arabia, Yemen,... etc <b>Africa;</b> Egypt, Libya, Sudan, etc <b>W. Europe;</b> Germany, Spain, Croatia, Slovenia,... etc
CIS/E. Europe	<b>D/K:</b> East European TV Standard	CIS, Czech, Hungary, Poland, Rumania,... etc
China	<b>D/K:</b> China TV Standard	China, Mongolia
Hongkong/UK	<b>I:</b> British TV Standard (UHF Only)	Hongkong, United Kingdom
Australia	<b>B/G,H:</b> Australian TV Standard	Australia
NZ/Indonesia	<b>B/G,H:</b> W. European TV Standard (1-11)	Indonesia, New Zealand
South Africa	<b>I:</b> British TV Standard (VHF/UHF)	South Africa
America	<b>M:</b> American TV Standard	Canada, Chile, Colombia, Mexico, Philippines, Taiwan, U.S.A,... etc

### ➤ TV Channel selection mode

If you press the P/C button repeatedly, the display mode changes cyclicly.

Program mode → Real CH mode → Cable CH mode



# Tuning Procedure (Manual store)

ENG

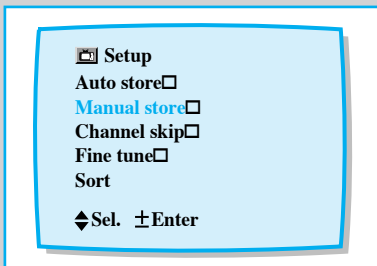

When storing channels manually, you can choose:

- ◆ Whether or not to store each of the channels found.
- ◆ The number by which you wish to identify each stored channel.

Method 1: To memorise channels by searching channels.

- 1 Press the MENU button on the TV set.
  - ◆ Move to "Setup" option by pressing CH▲ or CH▼ buttons and press the VOL+ or VOL- buttons.
- 2 Move to "Manual store" option by pressing CH▲ or CH▼ buttons and press the VOL+ or VOL- buttons.
  - ◆ Place on "Ch. No." option and press VOL+ or VOL- buttons.
- 3 On this mode, channel is increased or decreased by pressing VOL+ or VOL- buttons and where real channel is broadcasted, it stops.
  - ◆ While searching, the frequency corresponding to the channel is displayed at the same time, sub picture is disappeared.
  - ◆ In "Manual store" mode, sub picture is displayed, automatically, sub picture's channel number is corresponding to indicated "Pr. No." option.
- 4 When you find the channel which you want, move to "Pr. No." option and designate the number which you want to store by VOL+ or VOL- buttons.
- 5 Move to "Store" option and press VOL+ or VOL- buttons to store. "Store : OK" indicates that storage is done.
- 6 When you have finished manual storage, press menu repeatedly until the menus disappear.

- ◆ You can also select a CATV channel mode by pressing the P/C button on the transmitter.
- ◆ If you wish to view broadcasts from neighbouring countries, you can change "Area" by VOL+ or VOL- buttons.
 

Asia/W. Europe → CIS/E. Europe → China → Hongkong/UK  
 ↑  
 America ← South Africa ← NZ/Indonesia ← Australia ↓

☎ If the colour is abnormal, move to "Colour" option and set the colour until the colour becomes normal.

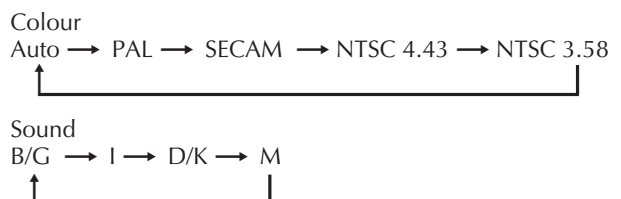

# Tuning Procedure (Manual store) (cont.)

## Method 2 : To memorise channels by searching frequency.

- 1 Press the MENU button on the TV set.
  - ◆ Move to "Setup" option by pressing CH▲ or CH▼ buttons and press the VOL+ or VOL- buttons.

---

- 2 Move to "Manual store" option by pressing CH▲ or CH▼ buttons and press the VOL+ or VOL- buttons.
  - ◆ Place "Search" option and press VOL+ or VOL- buttons.

---

- 3 On this mode, frequency is increased or decreased by pressing VOL+ or VOL- buttons and where real channel is broadcasted, it stops.

---

- 4 When you find the frequency of channel which you want, move to "Pr. No." option and designate the number which you want by VOL+ or VOL- buttons.

---

- 5 Move to "Store" option and press VOL+ or VOL- buttons to Store. "Store : OK" indicates that storage is done.

---

- 6 When you have finished manual storage, press "MENU" repeatedly until the menus disappear.

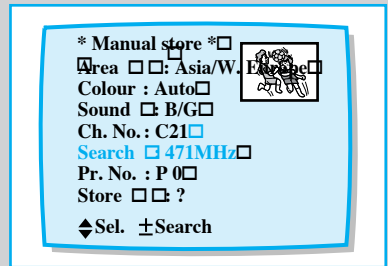
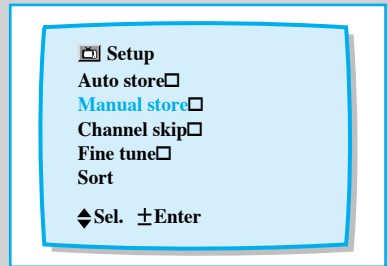

- ◆ If you wish to view broadcasts from neighbouring countries, you can change "Area" by VOL+ or VOL- buttons.

Asia/W. Europe → CIS/E. Europe → China → Hongkong/UK  
 ↑  
 America ← South Africa ← NZ/Indonesia ← Australia ↓

- ◆ PAL, SECAM and NTSC 3.58 are different colour signal broadcast transmission systems applicable to differing countries. NTSC 4.43 is a trick playback mode used in special VCR's to playback NTSC recorded video tapes through PAL television equipment.

## Tuning Procedure (Channel skip)

ENG



Menu  
 Picture  
 Sound  
 Time  
 Setup  
 Function  
 PinP  
 ◆Sel. ±Enter

Setup  
 Auto store  
 Manual store  
 Channel skip  
 Fine tune  
 Sort  
 ◆Sel. ±Enter

\* Channel skip \*  
 P 0 : Erased  
 P 1 : Added  
 P 2 : Added  
 P 3 : Added  
 P 4 : Added  
 ◆Sel. ±Set



*You can exclude the channels of your choice from the channel scan operation. When you scan through the stored channels, those you have chosen to skip are not displayed.*

- 1 Press the MENU button on the TV set.
  - ◆ Move to "Setup" option by pressing CH▲ or CH▼ buttons and press the VOL+ or VOL- buttons.
- 2 Move to "Channel skip" option by pressing CH▲ or CH▼ buttons.
  - ◆ To set the Channel skip press the VOL+ or VOL- buttons.
- 3 Use the CH▲ or CH▼ buttons to select the channel of your choice.
  - ◆ Add or Erase the desired channel by pressing VOL+ or VOL- button.
  - ◆ At this point, selected channel is displayed on the Sub picture.
- 4 When you have finished adding and erasing channels, press Menu repeatedly until the menus disappear.

### Programme Number Selection

e.g. To select programme number '24' (two digit).  
(When the CHANNEL SELECTION buttons(0~9) are used.)

e.g. To select programme number '7' (one digit).

- ◆ Press the DISPLAY button.
- ◆ The programme number, Colour system, picture mode and Sound system, and Sound mode, etc are displayed.

## Tuning Procedure (Fine tune)

If the reception is clear, you do not have to fine-tune the channel, as this is done automatically during the search and store operation. If however the signal is weak or distorted, you may have to fine-tune the channel manually.

- 1 Press the MENU button on the TV set.
  - ◆ Move to "Setup" option by pressing CH▲ or CH▼ buttons and press the VOL+ or VOL– buttons.
- 2 Move to "Fine tune" option by pressing CH▲ or CH▼ buttons.
  - ◆ To enter the "Fine tune" press the VOL+ or VOL– button.
- 3 Use VOL+ or VOL– buttons until you obtain a sharp and clear picture and good sound quality.
  - ◆ Select "Store" option by VOL+ or VOL– buttons if you wish to memorise adjusted picture or sound.  
Select "Erase" option by VOL+ or VOL– buttons if you wish to erase.
- 4 When you have finished press Menu repeatedly until the menus disappear.

- ◆ After you execute "Fine tune" store, the "\*" symbol appears to the left of the program No. and Real CH. No and then changes colour to red.

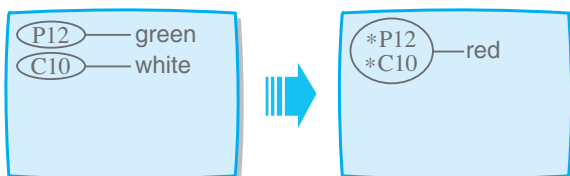

- ◆ This tells you that the set's Automatic Fine Tuning has been disabled for that program Number.

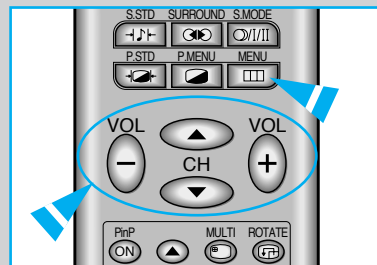

Menu   
 Picture   
 Sound   
 Time   
 Setup   
 Function   
 PinP   
 ◆ Sel. ± Enter

Setup  
 Auto store   
 Manual store   
 Channel skip   
 Fine tune    
 Sort  
 ◆ Sel. ± Enter

\* Fine tune \*   
 Tune : - +   
 Store : ?   
 Erase : ?   
  
   
 ◆ Sel. ± Adjust

## Tuning Procedure (Sort)

ENG



- Menu
- Picture
- Sound
- Time
- Setup
- Function
- PinP

◆Sel. ±Enter

### Setup

- Auto store
- Manual store
- Channel skip
- Fine tune
- Sort

◆Sel. ±Enter

### \* Sort \*

From : P 1   
To : P 3   
Store : ?



◆Sel. ±No. Set

### \* Sort \*

From : P 1   
To : P 3   
Store : ?



◆Sel. ±No. Set

You can exchange the numbers of two channels, in order to:

- ◆ Modify the numeric order in which the channels have been automatically stored.
- ◆ Give easily remembered numbers to the channels that you watch most often.

- 1 Press the MENU button and move to "Setup" option.
  - ◆ Press VOL + or VOL- buttons to display "Setup" menu.
- 2 Move to "Sort" option and press VOL+ or VOL- buttons to display "Sort" menu. Then "Sort" menu is displayed on the "From" option.
- 3 Press VOL+ or VOL- buttons until the channel number that you wish to change is displayed. Then the selected channel's picture is displayed on sub picture.
- 4 Press CH▲ or CH▼ buttons to place on "To" option.
  - ◆ Press VOL+ and VOL- buttons until the new number by which you wish to identify the channel is displayed. Then the selected channel is exchanged with the one previously stored to the chosen number.
- 5 Here's an example.
  - ◆ If you select "1" for the "From" option and "3" for the "To" option :
    - Channel 1 becomes channel 3.
    - Channel 3 becomes channel 1.
- 6 Move to Store line with the CH▲ or CH▼ button. Press the VOL+ or VOL- buttons.
  - ◆ "OK" is displayed on the store line.
- 7 Move the channel to the programme number you desire by repeating the process from No.3 to No.5.
- 8 When you have finished adding and erasing channels. Press MENU repeatedly until the menus disappear.

- ◆ If you change the programme number on the "From" line after storing, the programme number on the "To" line automatically increases by 1.
- ◆ The existing channels of the programme number displayed on "To" disappears when performing above functions.

# Picture Adjustment

By pressing the P.STD button, you can sequentially select any one of the five possible preferred analogue picture presets.

- 1 Press the P.STD button.
  - ◆ Whenever this button is pressed, the mode will be changed as follows.

↳ Custom → Standard → Dynamic → Movie → Mild

<b>Custom</b>	Select this mode to view the adjusted picture you want.
<b>Standard</b>	Select this mode to view the factory-preset standard picture.
<b>Dynamic</b>	<ul style="list-style-type: none"> <li>◆ Select this mode to view a powerful and clear picture.</li> <li>◆ For watching in brighter (day light) environments.</li> </ul>
<b>Movie</b>	Select this mode to enjoy the atmosphere as if you were in a movie theatre.
<b>Mild</b>	<ul style="list-style-type: none"> <li>◆ Select this mode                             <ul style="list-style-type: none"> <li>- To emphasize mildness.</li> <li>- When the surrounding are dark.</li> <li>- To decrease eye fatigue.</li> </ul> </li> </ul>

You can sequentially select and adjust one of five picture levels.  
 ◆ Contrast, Brightness, Colour, Sharpness or Tint (NTSC only)

## e.g. Contrast Adjustment

- 1 Press the MENU button. Move to "Picture" option by pressing the CH▲ or CH▼ buttons and press the VOL+ or VOL- buttons.
- 2 Move to "Contrast" by pressing the CH▲ or CH▼ buttons and press the VOL+ or VOL- buttons.
- 3 Adjust 100 "Contrast" by VOL+ or VOL- buttons.
- 4 When you have finished contrast adjustment, press Menu repeatedly until the menus disappear.

➤ In the circumstances of colour broadcasting, the colour does not disappear completely even if you minimize the colour control level.

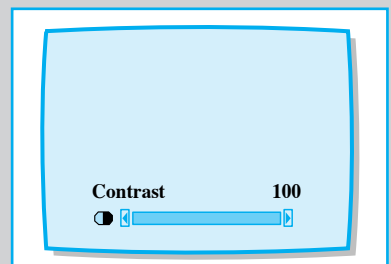
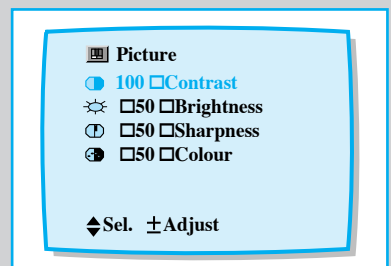
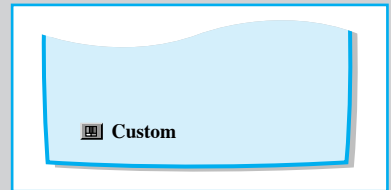

## Picture Menu Adjustment

ENG

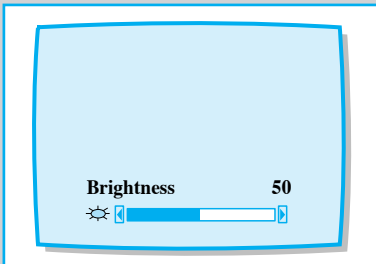
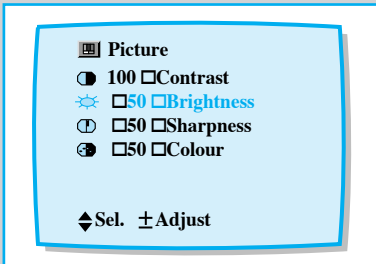

*If you select this mode, you can directly adjust "Brightness" without "MENU" option.*

*e.g. Brightness Adjustment by "P.MENU" button.*

- 1 Press the "P. MENU" button on the remote control.  
◆ "Picture" menu is displayed.
- 2 Move to "Brightness" by pressing the CH ▲ or CH ▼ button and press the VOL+ or VOL- button.
- 3 Adjust "Brightness" by VOL+ or VOL - buttons.
- 4 When you have finished Brightness adjustment, press "MENU" repeatedly until the menus disappear.



# Sound Adjustment

There is a choice of four audio settings. By pressing the S.STD button any one of the five settings can be in the sequence illustrated.

- 1 Press the S.STD button.
  - ◆ whenever this button is pressed, the mode will be changed as follows.

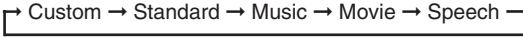

<b>Custom</b>	Select this mode to hear the adjusted sound you want.
<b>Standard</b>	Select this mode to hear the factory-preset standard sound.
<b>Music</b>	Select this mode to hear the music.
<b>Movie</b>	Select this mode to view the movie.
<b>Speech</b>	Select this mode to hear the voice clearly.

- Sound Cutoff
  - ◆ Press the MUTE button to turn off the sound
  - ◆ To restore sound, press it again.

You can sequentially select and adjust one of six sound levels (Bass, Treble, Balance, Volume, Bass AMP, Surround).

## e.g. Treble Adjustment

- 1 Press the MENU button. Move to "Sound" option by pressing the CH▲ or CH▼ buttons.
- 2 Press the VOL+ or VOL- buttons. Move to "Treble" option by pressing the CH▲ or CH▼ buttons.
- 3 Press the VOL+ or VOL- buttons.
  - ◆ The sound level is adjusted.

- You can enjoy more powerful bass sound.
  - ◆ Press the menu button. Move to "Sound" option by pressing the CH▲ or CH▼ buttons.
  - ◆ Press the VOL+ or VOL- buttons to set "Bass AMP : ON". Move to Bass AMP option by pressing the CH▲ or CH▼ buttons.

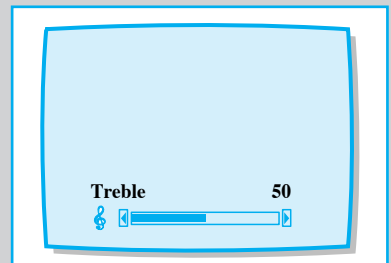
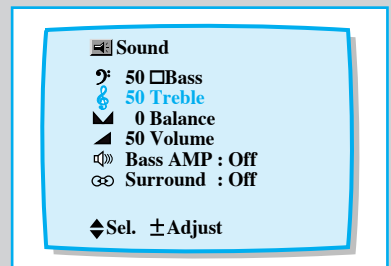

## Sound Adjustment (Surround)

ENG

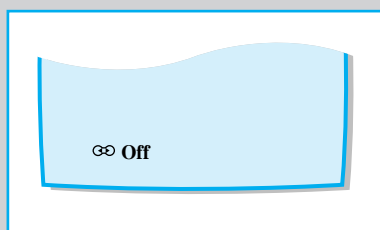

1 Press the "SURROUND" button.

- ◆ As you press it repeatedly it changes in the order of Mono, Concert, Stadium and Off.

**Off** You cannot hear stereophonic sound.

**Mono** Select this mode to hear normal mono signal in stereophonic sound.

**Concert** Select this mode to hear music similar to a performance in a concert hall (available for stereo broadcasting).

**Stadium** Select this mode to hear a vivid sound, like in a stadium when watching sports broadcasts.

- ◆ For stereophonic effect, functions of "Stadium" and "Concert" are available for stereo broadcast.
- ◆ What is stereophony?  
It is lively sound that you hear at the concert or stadium.

## Stereo Mode Functions

By pressing the S. MODE button, you can determine the way in which the audio signal is produced at the loudspeakers and AV output.

Type	Type of broadcast	On-Screen indication	Remark
<b>NICAM</b> <b>STEREO</b> <b>(OPTION)</b>	Regular Broadcast □ (Standard Audio)	▽	NORMAL USE
	Regular+□ NICAM MONO	▽ NICAM ↔ ▽	NICAM □ ↔ MONO
	NICAM STEREO	○ NICAM ↔ ▽	NICAM □ ↔ MONO
	NICAM DUAL I/II	→ Dual-I □ → Dual-II □ → ▽ NICAM NICAM	→ Dual-I → Dual-II → ▽
<b>A2 STEREO</b>	Regular Broadcast □ (Standard Audio)	▽	NORMAL USE
	BILINGUAL or □ DUAL I/II Mode	Dual-I ↔ Dual-II	Dual-I ↔ Dual-II
	STEREO	○ ↔ ▽	STEREO ↔ FORCED MONO

- 1. When the power is switched ON, the mode is automatically preset at either "DUAL-I" or "STEREO", depending on the current transmission.
- 2. When the receiving conditions deteriorate, listening will be easier if the mode is set to the "FORCED MONO" position using the Stereo/Bilingual Sound selection button.
  - ◆ If the stereo signal is weak or the receiving conditions are poor or if STEREO: MONO automatic switching occurs, it is recommended that you to switch to the "Forced Mono" Mode.

## Setting the Timer

You can select a time period of between 15 and 180 minutes after which the television automatically switches to standby mode.

- 1 Press the SLEEP button.
  - ◆ Whenever this button is pressed, the time will be changed.
 

☑ Off → 15 → 30 → 45 → 60 → 90 → 120 → 150 → 180 → ☑ Off
  - ◆ During the last minute before switching to stand-by mode, a clock symbol and the indication "☑ 1 Off" are displayed.

➤ To cancel the sleep timer function, press SLEEP repeatedly until the word "☑ Off" is displayed.



## Setting the Clock

You can set the television's clock so that the current time will be displayed when you press the DISPLAY button on the remote control.

- ◆ You must set the current time before you can set the automatic On/Off timer.
 

e.g. To enter a time of 12:00

- 1 Press the MENU button and move to "Time" option by CH▲ or CH▼ buttons.
  - ◆ Press VOL+ or VOL- button and press it again.
- 2 Adjust "Hour" by CH▲ or CH▼ buttons.
  - ◆ Whenever these buttons are pressed, the hour increases or decreases by 1.
- 3 Press VOL+ button and adjust "Minute" by CH▲ or CH▼ buttons.
  - ◆ Whenever these buttons are pressed, the minute increases or decreases by 1.
- 4 Press the MENU button to return to the main menu.

### ➤ NOISE TIMER Mode

If the set is not switched off when the TV station stops broadcasting, it will automatically go to Stand-by Mode after 15 minutes.

This function will not operate when the Television set is in AV Mode or TELETEXT mode.

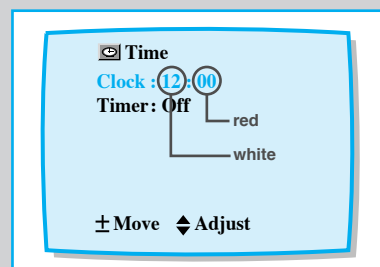

## Setting the On/Off Timer

ENG

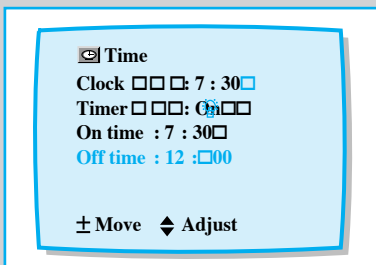
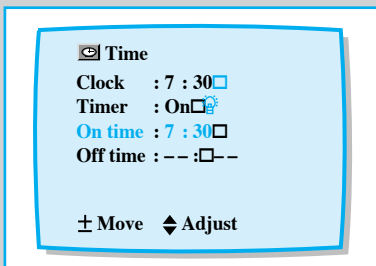
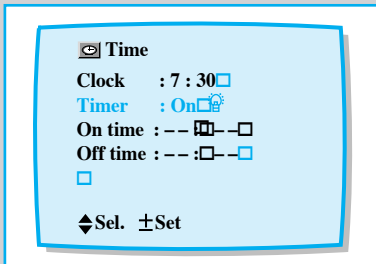
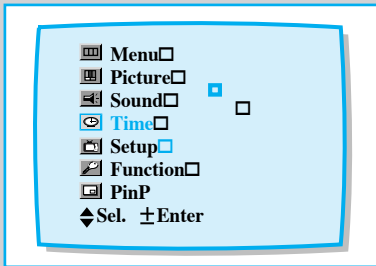

*By setting the ON/OFF time, the set carries out alarm and automatic off function.*

- 1 Press the MENU button.
  - ◆ The "Menu" picture is displayed on the screen.
- 2 Move "Time" option by pressing the CH▲ or CH▼ buttons and press the VOL+ or VOL- buttons.
  - ◆ "Time" picture is displayed on the screen.
- 3 Move to "Timer" option by CH▲ or CH▼ buttons and press VOL+ or VOL- buttons to set "Timer" on.
- 4 Move to "On time" by CH▲ or CH▼ and press VOL+ or VOL- buttons to set time. (refer to page 27.)
- 5 Move to "Off time" by CH▲ or CH▼ and press VOL+ or VOL- buttons to set time. (refer to page 27.)
- 6 Press the MENU button to return to the main menu.

- ◆ If you have not yet set the television's clock, the message "Set clock first" is displayed.
- ◆ If this happens, refer to "Clock" on the previous page.

## Extra Functions

Press the MENU button. Move to a function by pressing the CH▲ or CH▼ button. Adjust it by pressing the VOL+ or VOL- button.

<b>Language</b>	◆ To view the "MENU" mode with the language spoken in your Area.
<b>Blue screen</b>	◆ When no picture signal is input, or the signal is weak, the screen reverts to a blue background colour. To continue viewing very weak signals disable this feature.
<b>Noise Reducer</b>	◆ To prevent Noise on the picture caused by the weak broadcasting signal or an external interference signal. Blue screen menu isn't display when in AV mode.
<b>Low noise AMP</b>	◆ To amplify not Noise but TV signal in the weak signal Area. ◆ This function is working only weak signal condition, and that is memorized on current program number, additionally.
<b>Demonstration</b>	◆ All the menu pages appear repeatedly in sequence. To stop demonstration, press any button.

➤ On A/V mode, "Blue screen" and "Low noise AMP" can not be selected by user.

Function  
Language  : English  
Blue screen  : Off  
Noise Reducer  : Off  
Low noise AMP  Off  
Demonstration  Off

Function  
Language  : English  
Blue screen  : On  
Noise Reducer  : Off  
Low noise AMP  Off  
Demonstration  Off

Function  
Language  : English  
Blue screen  : Off  
Noise Reducer  : On  
Low noise AMP  Off  
Demonstration  Off

Function  
Language  : English  
Blue screen  : Off  
Noise Reducer  : Off  
Low noise AMP  On  
Demonstration  Off

Function  
Language  : English  
Blue screen  : Off  
Noise Reducer  : Off  
Low noise AMP  Off  
Demonstration  On

◆ Sel. ± Enter

## Picture in Picture (Option)

ENG

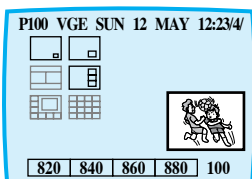
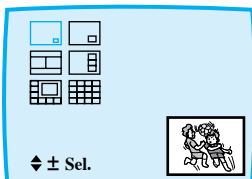
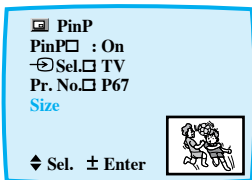
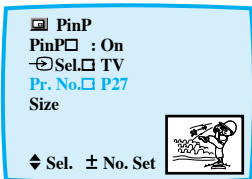
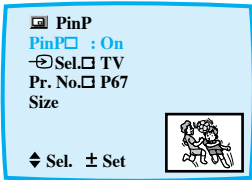

*With this function you can display a “PIP screen” (small picture) within the main picture of TV program or video input. In this way you can watch or monitor TV program or the video input from any connected equipment while watching TV or other video input. For information about connection of other equipment, see page 7-12.*

- 1 Press the MENU button and move to “PinP” option by CH▲ or CH▼ buttons. Press the VOL+ or VOL- buttons to set “PinP : On”.
- 2 Move to “-[ ] Sel. [ ] TV” option by pressing the CH▲ or CH▼ buttons and press the VOL+ or VOL- buttons to set “-[ ] Sel. : TV”.
  - ◆ Choose this function to convert source memorised on Sub Picture.
  - ◆ If set to “TV”, you can view on-air broadcasting through Sub Picture. If set to “VIDEO”, you can view video tape recorded by VCR through Sub Picture.
  - ◆ If set to “VIDEO”, “Pr. No.” option is not selected.
- 3 Move to “Pr. No.” option by pressing the CH▲ or CH▼ buttons and press the VOL+ or VOL- buttons to select the channel that you want to view through Sub Picture.
- 4 Move to “Size” option by pressing the CH▲ or CH▼ buttons and press the VOL+ or VOL- buttons to adjust the type of Sub Picture.
  - ◆ On TELETEXT mode, you can choose only 3 type of Sub Picture.
- 5 If you wish to hear Sub Picture’s sound, you must connect extra Headphone (Wireless headphone) to rear of the set.
  - ◆ Sub Picture was selected VIDEO mode, if set to “Main picture=VIDEO”, you can not hear the Sub Picture’s sound.
  - ◆ Wireless headphone can be purchased separately.

# Picture in Picture (Option)

➤ Preference : Concerning the functions of “PinP : On”.

- PIP ON/OFF button** ◆ Press this button to operate ON/OFF function of PIP on the remote control directly.
- CH▲ / ▼ button** ◆ Press this button to select the channel of Sub picture.
- MULTI button** ◆ Press the MULTI button to view memorized channels to a maximum of 16 on the Sub picture spontaneously.
- ROTATE button** ◆ Press the ROTATE button. Each press of the button moves the PIP in a counter clockwise direction.
- SWAP button** ◆ Press the SWAP button to exchange from Main picture to Sub picture and vice versa.
  - When the Main picture is in the Video mode and the Sub picture is in the TV mode, you might not hear the sound of Main picture when pressing the SWAP button after changing the Sub picture channel. At this time, reselect the Main picture channel.

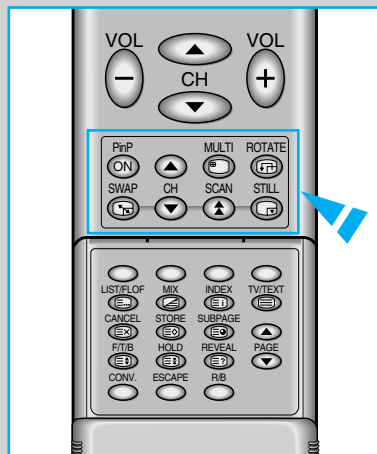

- SCAN button** ◆ Press the SCAN button to scan every memorized channel in order. Press it again to stop scanning.

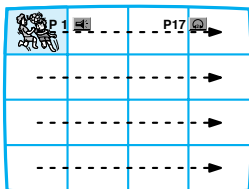

- ◆ If you press the PIP button during scanning, you can select the wanted Program channel directly.
- ◆ If you press the PIP button again, Multi PIP is selected in the 16 PIP mode.

- STILL button** ◆ Press the STILL button to freeze a moving Picture.
  - In case of sub picture “off”: Still the main moving picture.
  - In case of sub picture “on”: Still the sub moving picture.
- ◆ On still mode, Still symbol (II) was displayed.

- ◆ On the condition of Multi PIP it is impossible to execute Swap and Still.
- ◆ Everytime the “MULTI” button is pressed, the Program number and the location of the sub picture are changed. (See figures below)

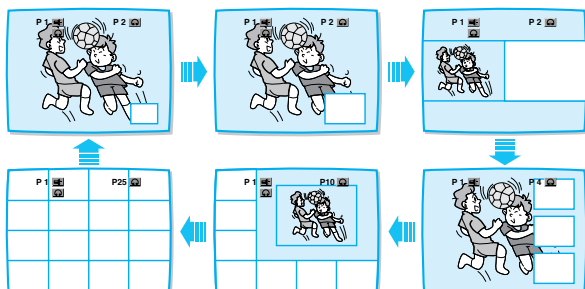

- ◆ On selecting 16 PIP mode, you can hear the sound of Main Picture. If you wish to hear the Sub Picture’s sound, you must connect Wireless headphone to rear of the set.

## Convergence Adjustment

ENG

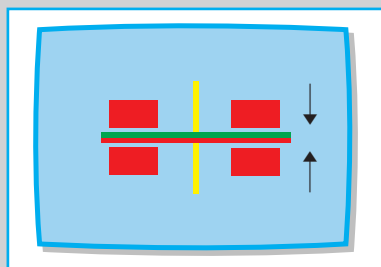
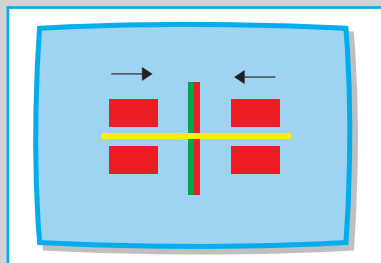
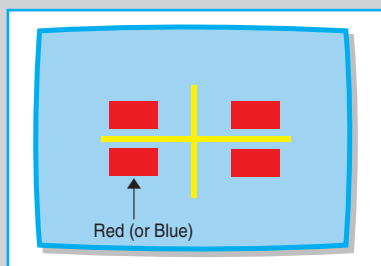
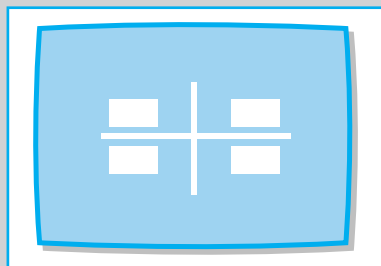

*If Color blurring occurs on the picture or picture is out of focus, press the CONV. for adjustment.*

*Upon completion of the adjustment, the color of “” changes to white*

- 1 Press the CONV. button.
- 2 Press the R/B button, “Red” or “Blue” is displayed alternately.
- 3 To adjust horizontality. Adjust the horizontal line to “Yellow” (or “Cyan”) by press the VOL+ or VOL– button.
- 4 To adjust verticality. Adjust the vertical line to “Yellow” (or “Cyan”) by press the CH▲ or CH▼ buttons.
- 5 Upon completion of the adjustment press the ESCAPE button.

- ◆ In Arabian OSD, enter the convergence mode by pressing the **CONV.** button on the remote control.
- ◆ Press the **ESCAPE** button to switch to the TV mode. And then the TV set is automatically turned Off and back On. (This process indicates that the micom automatically reboots because the convergence data is saved in it.)



# Teletext Operation

Teletext is additional information that is broadcast by the TV station along with the TV programme.

The built-in Teletext decoder of your set enables you to display this additional information on the screen.

Teletext is transmitted in the form of texts or graphic representations, or as subtitles to the TV programme.

The latter is intended to help the hard of hearing.

Teletext is transmitted page by page.

The pages are numbered and may be selected by remote control.

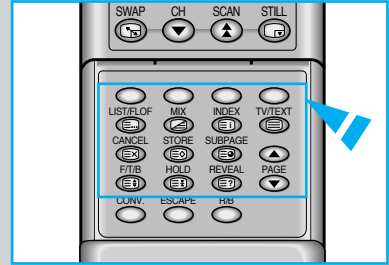

## TV/TEXT button

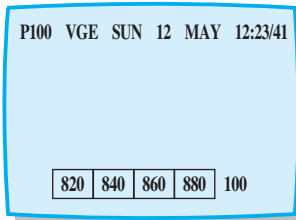

- ◆ Press this button to change from TV to teletext mode.
- ◆ Press again this button to change back to TV mode.

## SUBPAGE button



- ◆ To view a particular subpage, after pressing this button, the subpage number with the numeric buttons. Press the "SUBPAGE" button again to restore the initial time status Z\*\*\*\*(S\*\*\*\*).

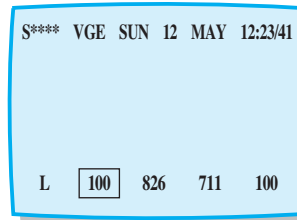
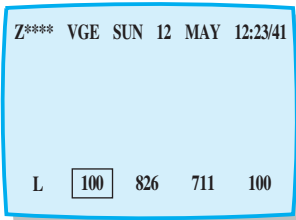

## INDEX button



- ◆ With the teletext "INDEX" button, you can select any page from the index on page 100. This remains stored at all times.

### FLOF TELETEXT MODE :

When the "INDEX" button is pressed the current subpage changes to the upper subpage.

### LIST TELETEXT MODE :

When the "INDEX" button is pressed the current page changes to the first memorised page.

## CANCEL Button



- ◆ While the search is in progress for a selected page, the normal TV picture can be viewed by pressing this button. When the page has been found, its number will be displayed in the left corner of the top line. To view the selected page press the "CANCEL" button.

# Teletext Operation

ENG

**F/T/B button**  
()

- ◆ This function is used when the characters on the TV screen are hard to read. Pressing it the 1st time expands the TOP half of the display only. Pressing it the 2nd time expands the bottom half of the display only. Pressing it the 3rd time returns the display to its original size.

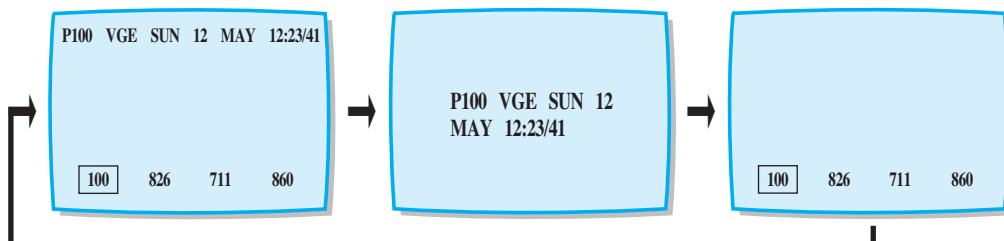

**NUMERIC button**

- ◆ Press these buttons to select the "TELETEXT" page required.

**PAGE UP button**  
()

- ◆ Press this button to display the next TTX page.

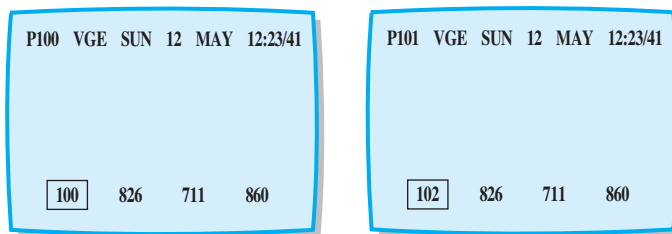

**PAGE DOWN button**  
()

- ◆ Press this button to display the previous page.

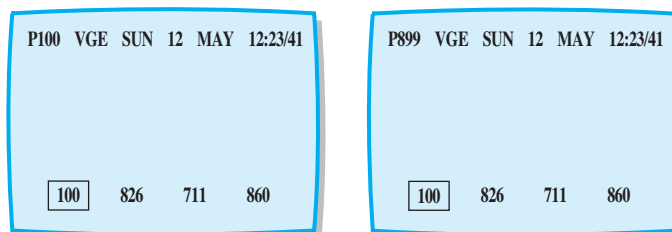



**MIX button**  
()

- ◆ Press this button in TTX mode to display TTX and TV screen simultaneously. To revert back to the TV programme alone, press the TV button.

**HOLD (HALT) button**  
()

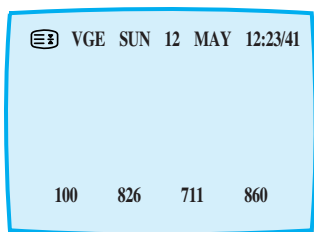
- ◆ When TELETEXT information exceeds more than one page, the display changes automatically to the next page. To hold a particular page, press this button. This display will remain until the hold button is pressed again.



**REVEAL button**  
()

- ◆ Press this button to reveal concealed information. (e.g. the solution to a riddle or a puzzle.) Press again to conceal information.

- ◆ In the teletext mode press the MIX button to have text superimposed over the normal programme picture.
- ◆ Press the TTX button to return to TELETEXT mode.

# Teletext Operation

## ➤ How to store textpages (list mode)

List mode is a convenient way of accessing some teletext pages without the need to enter page numbers. In this mode, 4 page numbers can be preset for each programme number 0 to 59.

A maximum of 240 pages can be programmed (e.g. 4 pages x 60 programme numbers). Any one of these 4 pages can be displayed instantly by pressing the corresponding "colour-coded" button on the remote control.

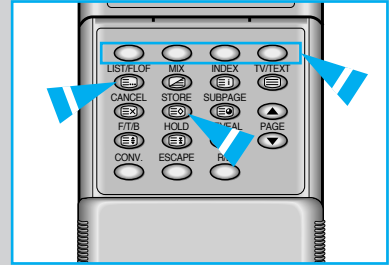

### 1 LIST mode

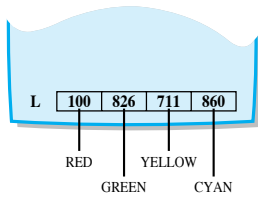

### FLOF mode

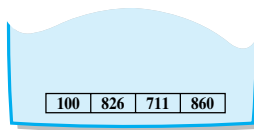

(Teletext must be selected first.)

Select the "list" mode by pressing the LIST/FLOF button (  ). Pressing this button will switch between the "LIST and FLOF" modes.

- 2 To select a memory position, press one of the "colour-coded" buttons.
- 3 Enter the page number of the desired teletext page by pressing these buttons "0" to "9".
- 4 Press the TTX STORE button (  ) until the background colour changes to white.

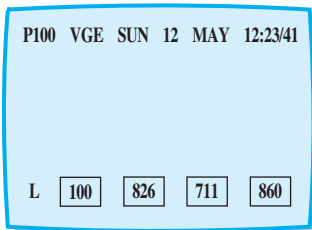

- 5 Subsequently pressing any one of the coloured buttons will display the page stored against it.

# Specification

ENG

AREA CH. DISPLAY	RECEIVE CHANNEL									
	ASIA/ W.EUROPE	CIS/ E.EUROPE	CHINA	HK/UK	AUSTR- ALIA	NZ/IN- DONESIA	SOUTH AFRICA	AMERICA	CABLE	
									OTHERS	AMERICA
00	-	-	-	-	0	-	-	-	-	-
01	-	1	1	-	1	1	-	-	01	01
02	2	2	2	-	2	2	-	2	02	02
03	3	3	3	-	3	3	-	3	03	03
04	4	4	4	-	4	4	4	4	04	04
05	5	5	5	-	5	5	5	5	05	05
06	6	6	6	-	6	6	6	6	06	06
07	7	7	7	-	7	7	7	7	07	07
08	8	8	8	-	8	8	8	8	08	08
09	9	9	9	-	9	9	9	9	09	09
10	10	10	10	-	10	10	10	10	10	10
11	11	11	11	-	11	11	11	11	11	11
12	12	12	12	-	5A	-	-	12	12	12
13	-	-	13	-	-	-	13	13	13	13
14	-	-	14	-	-	-	-	14	14	14
15	-	-	15	-	-	-	-	15	15	15
16	-	-	16	-	-	-	-	16	16	16
17	-	-	17	-	-	-	-	17	17	17
18	-	-	18	-	-	-	-	18	18	18
19	-	-	19	-	-	-	-	19	19	19
20	-	-	20	-	-	-	-	20	20	20
21	21	21	21	21	-	21	21	21	21	21
22	22	22	22	22	-	22	22	22	22	22
23	23	23	23	23	-	23	23	23	23	23
24	24	24	24	24	-	24	24	24	24	24
25	25	25	25	25	-	25	25	25	25	25
26	26	26	26	26	-	26	26	26	26	26
27	27	27	27	27	-	27	27	27	27	27
28	28	28	28	28	28	28	28	28	28	28
29	29	29	29	29	29	29	29	29	29	29
30	30	30	30	30	30	30	30	30	30	30
31	31	31	31	31	31	31	31	31	31	31
32	32	32	32	32	32	32	32	32	32	32
33	33	33	33	33	33	33	33	33	33	33
34	34	34	34	34	34	34	34	34	34	34

➤ For cable channels in "America" area the actual channel may be different from that shown in the table.

*continued...*

# Specification

AREA CH. DISPLAY	RECEIVE CHANNEL									
	ASIA/ W.EUROPE	CIS/ E.EUROPE	CHINA	HK/UK	AUSTR- ALIA	NZ/IN- DONESIA	SOUTH AFRICA	AMERICA	CABLE	
									OTHERS	AMERICA
35	35	35	35	35	35	35	35	35	35	35
36	36	36	36	36	36	36	36	36	36	36
37	37	37	37	37	37	37	37	37	37	37
38	38	38	38	38	38	38	38	38	38	38
39	39	39	39	39	39	39	39	39	39	39
40	40	40	40	40	40	40	40	40	40	40
41	41	41	41	41	41	41	41	41	41	41
42	42	42	42	42	42	42	42	42	-	42
43	43	43	43	43	43	43	43	43	-	43
44	44	44	44	44	44	44	44	44	-	44
45	45	45	45	45	45	45	45	45	-	45
46	46	46	46	46	46	46	46	46	-	46
47	47	47	47	47	47	47	47	47	-	47
48	48	48	48	48	48	48	48	48	-	48
49	49	49	49	49	49	49	49	49	-	49
50	50	50	50	50	50	50	50	50	-	50
51	51	51	51	51	51	51	51	51	-	51
52	52	52	52	52	52	52	52	52	-	52
53	53	53	53	53	53	53	53	53	-	53
54	54	54	54	54	54	54	54	54	-	54
55	55	55	55	55	55	55	55	55	-	55
56	56	56	56	56	56	56	56	56	-	56
57	57	57	57	57	57	57	57	57	-	57
58	58	58	-	58	58	58	58	58	-	58
59	59	59	-	59	59	59	59	59	-	59
60	60	60	-	60	60	60	60	60	-	60
61	61	61	-	61	61	61	61	61	-	61
62	62	62	-	62	62	62	62	62	-	62
63	63	63	-	63	63	63	63	63	-	63
64	64	64	-	64	64	64	64	64	-	64
65	65	65	-	65	65	65	65	65	-	65
66	66	66	-	66	66	66	66	66	-	66
67	67	67	-	67	67	67	67	67	-	67
68	68	68	-	68	68	68	68	68	-	68
69	69	69	-	69	69	69	69	69	-	69

## Trouble Shooting

ENG

No picture. No sound.	<ul style="list-style-type: none"><li>◆ Not plugged into A.C. supply.</li><li>◆ Not switched on.</li><li>◆ Check contrast, brightness and volume settings.</li></ul>
Normal picture. No sound.	<ul style="list-style-type: none"><li>◆ Check volume level.</li><li>◆ Check sound mute button on remote control.</li><li>◆ Check system</li></ul>
No colour. Normal sound.	<ul style="list-style-type: none"><li>◆ Check colour level.</li><li>◆ Check system</li></ul>
Interference on screen. Distorted sound.	<ul style="list-style-type: none"><li>◆ Electrical appliances, cars, motorcycles, fluorescent light.</li></ul>
Multiple image. Snowy picture. Distorted sound.	<ul style="list-style-type: none"><li>◆ Direction, location and or aerial connection.</li></ul>
Remote control malfunctions or reduction in operating distance.	<ul style="list-style-type: none"><li>◆ Replace batteries.</li><li>◆ Clean indicator window.</li><li>◆ Check battery terminals.</li></ul>

## Cleaning the TV

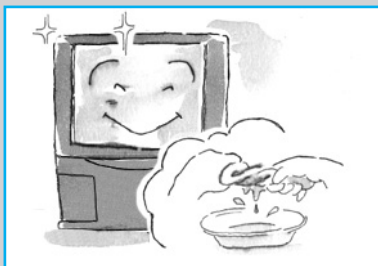
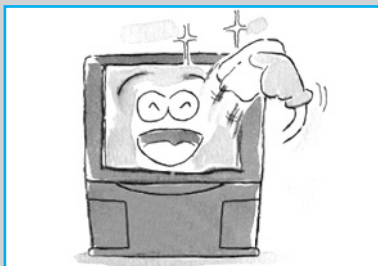

- 1 Wipe the outside of this TV set with a soft, dry cloth.
  - ◆ Do not use solutions containing benzol, petroleum or a chemical cloth.
- 2 Wipe the speaker of this TV set with a soft cloth moistened with water.

A large, empty rectangular box with a thin blue border, occupying most of the page. It is intended for writing the content of the memo.

---

## – AFTER SALES SERVICE

---

- Do not hesitate to contact your retailer or service agent if a change in the performance of your product indicates that a fault condition may be present.



AA68-11318A (ENG)