

SONY[®]

4-089-081-21



FD Trinitron
WEGA[®]

Operating Instructions

KV-27FS100
KV-27FS200
KV-32FS100
KV-32FS200
KV-36FS100
KV-36FS200

WARNING

To reduce the risk of fire or electric shock, do not expose the TV to rain or moisture.

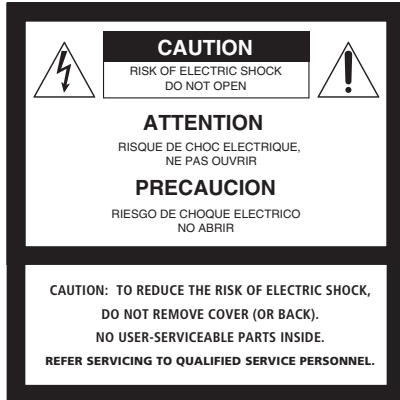

This symbol is intended to alert the user to the presence of uninsulated “dangerous voltage” within the product’s enclosure that may be of sufficient magnitude to constitute a risk of electric shock to persons.



This symbol is intended to alert the user to the presence of important operating and maintenance (servicing) instructions in the literature accompanying the appliance.

Note to the CATV Installer

This reminder is provided to call the CATV system installer’s attention to Article 820-40 of the NEC that provides guidelines for proper grounding and, in particular, specifies that the cable ground shall be connected to the grounding system of the building as close to the point of cable entry as practical.

SAFETY PRECAUTIONS

- Operate the TV only on 120 V AC.
- One blade of the power plug is wider than the other for safety purposes and will fit into the power outlet only one way. If you are unable to insert the plug fully into the outlet, contact your dealer.
- If any liquid or solid object falls into the TV, unplug it and have it checked by qualified personnel before operating it further.

CAUTION

When using TV games, computers, and similar products with your TV, keep the brightness and contrast functions at low settings. If a fixed (non-moving) pattern is left on the screen for long periods of time at a high brightness or contrast setting, the image can be permanently imprinted onto the screen. Continuously watching the same channel can cause the imprint of station logos onto the TV screen. These types of imprints are not covered by your warranty because they are the results of misuse.



To reduce the risk of electric shock, do not use this polarized plug with an extension cord, receptacle, or other outlet unless the blades can be fully inserted to prevent blade exposure.



You are cautioned that any changes or modifications not expressly approved in this manual could void your authority to operate this equipment.

NOTIFICATION

This equipment has been tested and found to comply with the limits for a Class B digital device pursuant to Part 15 of the FCC Rules. These limits are designed to provide reasonable protection against harmful interference in a residential installation. This equipment generates, uses, and can radiate radio frequency energy and, if not installed and used in accordance with the instructions, may cause harmful interference with radio communications. However, there is no guarantee that interference will not occur in a particular installation. If this equipment does cause harmful interference to radio or television reception, which can be determined by turning the equipment off and on, the user is encouraged to try to correct the interference by one or more of the following measures:

- Reorient or relocate the receiving antennas.
- Increase the separation between the equipment and receiver.
- Connect the equipment into an outlet on a circuit different from that to which the receiver is connected.
- Consult the dealer or an experienced radio/TV technician for help.

Protecting the TV

- To prevent internal heat build-up, do not block the ventilation openings.
- Do not install the TV in a hot or humid place, or in a place subject to excessive dust or mechanical vibration.

Note on Caption Vision

This television receiver provides display of television closed captioning in accordance with § 15.119 of the FCC rules. Use of this television for other than private viewing of programs broadcast on UHF or VHF or transmitted by cable companies for the use of the general public may require authorization from the broadcaster-cable company and/or program owner.

Owner’s Record

The model and serial numbers are located on the front cover of this manual and at the rear of your TV.

Trademarks and Copyrights

ENERGY STAR® is a registered mark.



As an ENERGY STAR® Partner, Sony has determined that this product or product model meets the ENERGY STAR® guidelines for energy efficiency.

WEGA, FD Trinitron and Caption Vision are registered trademarks of Sony Corporation.

IMPORTANT SAFEGUARDS

For your protection, please read these instructions completely, and keep this manual for future reference. Carefully observe and comply with all warnings, cautions and instructions placed on the set, or described in the operating instructions or service manual.

WARNING

To guard against injury, the following basic safety precautions should be observed in the installation, use, and servicing of the set.

Use

Power Sources

This set should be operated only from the type of power source indicated on the serial/model plate. If you are not sure of the type of electrical power supplied to your home, consult your dealer or local power company. For those sets designed to operate from battery power, refer to the operating instructions.



Grounding or Polarization

This set is equipped with a polarized AC power cord plug (a plug having one blade wider than the other), or with a three-wire grounding type plug (a plug having a third pin for grounding). Refer to the following instructions:

For the set with a polarized AC power cord plug

This plug will fit into the power outlet only one way. This is a safety feature. If you are unable to insert the plug fully into the outlet, try reversing the plug. If the plug still fails to fit, contact your electrician to have a suitable outlet installed. Do not defeat the safety purpose of the polarized plug by forcing it in.



Alternate Warning

For the set with a three-wire grounding type AC plug

This plug will only fit into a grounding-type power outlet. This is a safety feature. If you are unable to insert the plug into the outlet, contact your electrician to have a suitable outlet installed. Do not defeat the safety purpose of the grounding plug.

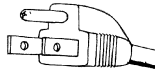

Overloading

Do not overload wall outlets, extension cords or convenience receptacles beyond their capacity, since this can result in fire or electric shock. Always turn the set off when it is not to be used. When the set is left unattended and unused for long periods of time, unplug it from the wall outlet as a precaution against the possibility of an internal malfunction that could create a fire hazard.

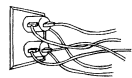

Do not disconnect the antenna or the power cord during a heavy storm. Lightning may strike while you are holding the cable or cord, causing serious injury. Turn off your TV and wait for the weather to improve.

Object and Liquid Entry

Never push objects of any kind into the set through the cabinet slots as they may touch dangerous voltage points or short out parts that could result in a fire or electric shock. Never spill liquid of any kind on the set.



Attachments

Do not use attachments not recommended by the manufacturer, as they may cause hazards. Do not place any objects, especially heavy objects, on top of the set. The object may fall from the set, causing injury.

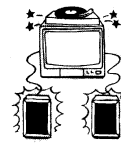

Cleaning

Unplug the set from the wall outlet before cleaning or polishing it. Do not use liquid cleaners or aerosol cleaners. Use a cloth lightly dampened with water for cleaning the exterior of the set.



If a snapping or popping sound from a TV set is continuous or frequent while the TV is operating, unplug the TV and consult your dealer or service technician. It is normal for some TV sets to make occasional snapping or popping sounds, particularly when being turned on or off.



Installation

Always use two or more people to lift or move the set. The set is heavy and the bottom surface is flat. Serious injury can result from trying to move the set by yourself alone, or from unsteady handling.

Install the set on a stable, level surface.

Water and Moisture

Do not use power-line operated sets near water — for example, near a bathtub, washbowl, kitchen sink, or laundry tub, in a wet basement, or near a swimming pool, etc.



Accessories

Do not place the set on an unstable cart, stand, tripod, bracket, table, or shelf. The set may fall, causing serious injury to a child or an adult, and serious damage to the set.



Use only a cart or stand recommended by the manufacturer for the specific model of TV. Any mounting of the product should follow the manufacturer's instructions, and should use a mounting accessory recommended by the manufacturer. An appliance and cart combination should be moved with care. Quick stops, excessive force, and uneven surfaces may cause the appliance and cart combination to overturn.

Disconnect all cables and cords from the set before attempting to move the set.

Do not allow children or pets to climb up onto, or push against, the set. The set may fall, causing serious injury.

Ventilation

The slots and openings in the cabinet and in the back or bottom are provided for necessary ventilation. To ensure reliable operation of the set, and to protect it from overheating, these slots and openings must never be blocked or covered.

- Never cover the slots and openings with a cloth or other materials.



- Never block the slots and openings by placing the set on a bed, sofa, rug or other similar surface.

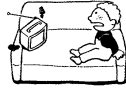

- Never place the set in a confined space, such as a bookcase or built-in cabinet, unless proper ventilation is provided.



- Do not place the set near or over a radiator or heat register, or where it is exposed to direct sunlight.



Power-Cord Protection

Do not allow anything to rest on or roll over the power cord, and do not place the set where the power cord is subject to wear or abuse.



Grounding or Polarization

This set may be equipped with a polarized alternating current line plug (a plug having one blade wider than other). This plug will fit into the power outlet only one way. This is a safety feature. If you are unable to insert the plug fully into the outlet, try reversing the plug. If the plug still fails to fit, contact your electrician to replace your obsolete outlet. Do not defeat the safety purpose of the polarized plug.

Antennas

Outdoor Antenna Grounding

If an outdoor antenna is installed, follow the precautions below. An outdoor antenna system should not be located in the vicinity of overhead power lines or other electric light or power circuits, or where it can come in contact with such power lines or circuits.

WHEN INSTALLING AN OUTDOOR ANTENNA SYSTEM, EXTREME CARE SHOULD BE TAKEN TO KEEP FROM CONTACTING SUCH POWER LINES OR CIRCUITS AS CONTACT WITH THEM IS ALMOST INVARIABLY FATAL.

Be sure the antenna system is grounded so as to provide some protection against voltage surges and built-up static charges. Section 810 of the National Electrical Code (NEC) in USA and Section 54 of the Canadian Electrical Code in Canada provides information with respect to proper grounding of the mast and supporting structure, grounding of the lead-in wire to an antenna discharge unit, size of grounding conductors, location of antenna discharge unit, connection to grounding electrodes, and requirements for the grounding electrode.

Antenna Grounding According to the NEC

Antenna Grounding According to the National Electrical Code, ANSI/NFPA 70.

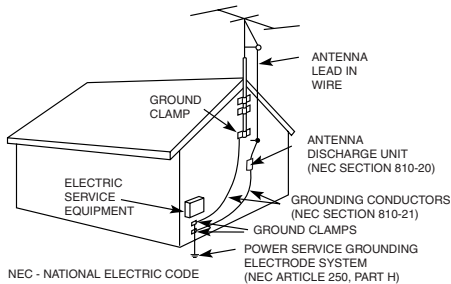

Lightning

For added protection for this television receiver during a lightning storm, or when it is left unattended and unused for long periods of time, unplug it from the wall outlet and disconnect the antenna. This will prevent damage to the receiver due to lightning and power-line surges.

Service

Damage Requiring Service

Unplug the set from the wall outlet and refer servicing to qualified service personnel under the following conditions:

- When the power cord or plug is damaged or frayed.

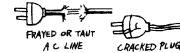

- If liquid has been spilled into the set or objects have fallen into the product.



- If the set has been exposed to rain or water.



- If the set has been subject to excessive shock by being dropped, or the cabinet has been damaged.

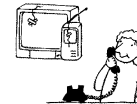

- If the set does not operate normally when following the operating instructions. Adjust only those controls that are specified in the operating instructions. Improper adjustment of other controls may result in damage and will often require extensive work by a qualified technician to restore the set to normal operation.



- When the set exhibits a distinct change in performance — this indicates a need for service.

Servicing

Do not attempt to service the set yourself since opening the cabinet may expose you to dangerous voltage or other hazards. Refer all servicing to qualified service personnel.



Replacement Parts

When replacement parts are required, be sure the service technician certifies in writing that he has used replacement parts specified by the manufacturer that have the same characteristics as the original parts. Unauthorized substitutions may result in fire, electric shock, or other hazards.



Safety Check

Upon completion of any service or repairs to the set, ask the service technician to perform routine safety checks (as specified by the manufacturer) to determine that the set is in safe operating condition, and to so certify. When the set reaches the end of its useful life, improper disposal could result in a picture tube implosion. Ask a qualified service technician to dispose of the set.



Contents

Introduction

Introducing the FD Trinitron WEGA® Features.....	1
About this Manual	2
Batteries for the Remote Control.....	2
Front Panel Menu Controls.....	2
Using the Remote Control	3

Connecting Your TV

TV Rear Panel.....	5
Basic Connections	7
Cable Box Connections	8
Connecting Additional Equipment	10

Using Basic Functions

Setting Up the TV Automatically.....	17
Quick Start to the Menus.....	18
Using Picture in Picture (PIP)	20
Setups that affect your ability to use PIP.....	22

Using the Menus

How to access menus.....	23
Using the Video Menu.....	24
Using the Audio Menu.....	25
Using the Channel Setup Menu.....	27
Using the Parent Menu	29
Using the Timer Menu.....	35
Using the Setup Menu	36
Using the Basic Menu.....	37

Other Information

Programming the Remote Control.....	39
Troubleshooting.....	42
Specifications.....	45

Index	47
--------------------	----

Introduction

Congratulations on your purchase of the Sony FD Trinitron WEGA®. Before you begin using this manual, please check the model number located on the rear of your TV or on the front cover of this manual.

Introducing the FD Trinitron WEGA® Features

Some of the features you will enjoy include:

- ❑ **FD Trinitron Flat CRT** — Technologically advanced tube delivers a picture with uncompromising accuracy and outstanding image detail.
- ❑ **Y, P_B, P_R Inputs** — A component video input connection for a superior picture quality (480i only).
- ❑ **Surround** — Simulates theater quality sound for stereo programs.
- ❑ **Parental Control (V-Chip)** — A tool to help parents monitor what their children watch on TV by establishing rating limits.
- ❑ **Picture in Picture (PIP)** — Allows you to view two programs simultaneously (KV-27FS200, KV-32FS200, KV-36FS200 only).
- ❑ **Favorite Channels** — Instant access to your favorite channels with the touch of a button.
- ❑ **Info Banner** — A new, convenient feature that displays the name and the remaining time of the current program viewed, if available.
- ❑ **Universal Remote Control** — Program your remote control to operate your connected cable box, VCR, digital satellite receiver, or DVD player.
- ❑ **Energy Star®** — Meets the Energy Star guidelines for energy efficiency.
- ❑ **Front Panel Controls** — Allows access to the on-screen menus without the use of a remote control.
- ❑ **Front A/V Inputs** — A quick connection for video games, camcorders or stereo/mono equipment.

About this Manual

This manual provides instructions to help you enjoy your new TV. It shows you how to connect to an antenna or cable, cable box, VCR, DVD, satellite receiver, stereo system, or camcorder. Once you're connected, follow the instructions and use the remote control to access the on-screen menus.

Batteries for the Remote Control

Insert two AA (R6) batteries (supplied) into the remote control using the following illustration as a guide.

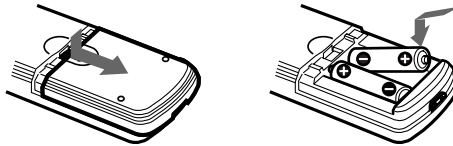



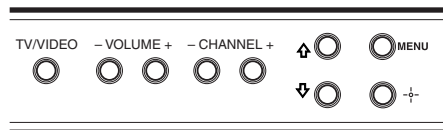

 Under normal conditions, batteries will last up to six months. If the remote control does not operate properly, the batteries might be worn out.

 If you will not be using the remote control for an extended period of time, remove the batteries to avoid possible damage from battery leakage.

Front Panel Menu Controls



























The front Audio/Video panel controls allows you to access the menu without the remote control.

- Press  to display the on-screen menu.
- Use the  and  buttons on the front Audio/Video panel instead of your remote control.
- Use the  button on the front Audio/Video panel to navigate through the menus, then select an item. The front panel controls also allows you to change your channels CH +/-, adjust the volume VOL +/-, and change video inputs.







 To navigate the menus with your remote control, see "Using the Menus" on page 23.

Using the Remote Control

 The remote control shown (RM-Y181) is for the models KV-27FS200, KV-32FS200 and KV-36FS200. The remote control for the models KV-27FS100, KV-32FS100, KV-36FS100 (RM-Y180); do not have the yellow labeled PIP function buttons.

Button	Description
 1	MUTING Press to turn off the sound. Press again or press  to restore sound.
 2	SYSTEM OFF Press to power off the equipment programmed into the remote control, see “Programming the Remote Control” on page 39.
 3	TV/VCR Press to switch between TV and VCR mode. If you have a non-Sony VCR, you will need to program the remote control to recognize your VCR. For details, see “Programming the Remote Control” on page 39.
 4	ANT (antenna) Press to change from VHF/UHF input to the AUX input, press again to switch back (KV-27FS200, KV-32FS200 and KV-36FS200 only).
 5	PICTURE MODE Press repeatedly to step through the available video picture modes: Vivid, Standard, Movie and Sports. Also available in the Video menu. See “Using the Video Menu” on page 24 for details.
 6	SLEEP Press repeatedly until the TV displays the time in minutes (15, 30, 45, 60, or 90) that you want the TV to remain on before shutting off automatically. Cancel by pressing until Sleep Off appears. While Sleep feature is set, press once to view remaining time.
 7	JUMP Press to jump back and forth between two channels. The TV alternates between the current channel and the last channel that was selected.
 8	TV/SAT Press to switch between the TV and SAT (satellite) inputs when in SAT FUNCTION mode.
 9	RESET Press to return to factory settings while in an on-screen menu.
 10	VOL (volume) Press (+) or (-) to adjust the volume.
 11	CODE SET Use to program your remote control to operate connected video equipment. See “Programming the Remote Control” on page 39.
 12	
 13	
 14	
 15	
 16	
 17	
 18	
 19	
 20	
 21	
 22	

Operating Instructions

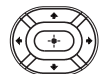
Button	Description
12 POWER buttons	Press to turn on and off the TV and other audio/video equipment you have programmed into the remote control. For instructions, see "Programming the Remote Control" on page 39.
13 FUNCTION buttons	Press to select the equipment (TV, VCR/DVD, SAT/CABLE) that you want to operate with the remote control. The indicator (LED) lights up momentarily when pushed to show which device the remote control is operating.
14 PIP (Picture in Picture)	Operates PIP feature. See "Using Picture in Picture (PIP)" on page 20.
VCR (operating)	Operates your VCR. The VCR must be programmed into the remote control. For instructions, see "Programming the Remote Control" on page 39.
REC	Press  button and the  button - above left - at the same time to record any programs with your VCR (the remote control must be programmed in order to use REC).
	Rewind.
	Fast-forward.
	Play.
	Stop.
II	Pause. Press again to resume normal playback.
15 TV/VIDEO	Press to cycle through available video inputs.
16 DISPLAY	Press once to display the current time and program status (such as channel number, channel label (if set), video input, and video label). Press again to turn display off.
17 MTS/SAP	Press to cycle through the Multi-channel TV Sound (MTS) options: Stereo, Auto SAP (Second Audio Programming), and Mono.
18 0-9 and ENTER	Press to change channels directly. The channel changes after 2 seconds.
19 GUIDE	Press to display the program guide of your satellite antenna.
20 	Press the arrow buttons to move the cursor in the on-screen menus. Press the center button to select or access an option.
21 MENU	Press to display the on-screen menu. Press again to exit the menu at any time.
22 CH (channel)	Press to change channels. To scan rapidly through the channels, press and hold down the CH+ or CH- button.

 For information on Picture in Picture (PIP) operation buttons, see page 21.

 If you lose your remote control, see page 44.

Connecting Your TV

Read this section before setting up your TV for the first time. This section covers basic connections in addition to any optional equipment you may be connecting.

 The TV rear panels illustrated in this manual are for KV-27FS200, KV-32FS200 and KV-36FS200. The KV-27FS100, KV-32FS100 and KV-36FS100; do not have the AUX input and TO CONVERTER output jack.

TV Rear Panel

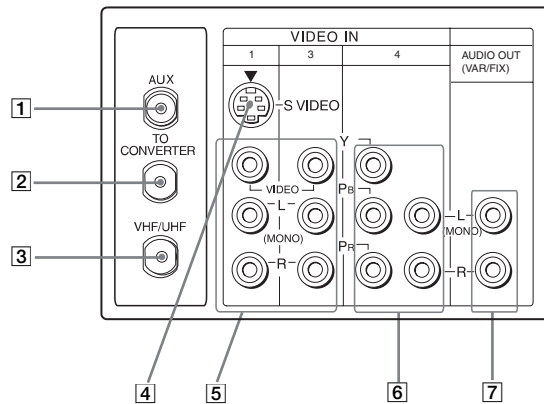

Jack	Description
1 AUX	This input allows you to view local and cable channels if your cable provider does not feature local channels. You can switch between local and cable channels easily by pressing ANT on the remote control. Devices connected to the AUX input cannot be viewed in PIP.
2 TO CONVERTER	This is a VHF/UHF out jack that lets you set up your TV to switch between scrambled channels (through a cable box) and normal cable channels (CATV). Use this jack instead of a splitter to get better picture quality when you need to switch between scrambled and unscrambled cable channels.
3 VHF/UHF	This input connects to your VHF/UHF antenna or cable.
4 S VIDEO	This input connects to the S VIDEO OUT jack on your VCR or other video equipment that has S VIDEO. S VIDEO provides better picture quality than the VHF/UHF jacks or the video input jack. S VIDEO does not provide sound; you still must connect the audio cables.

Operating Instructions

Jack	Description
5 AUDIO L(MONO), R/ VIDEO	This input connects to the AUDIO/VIDEO output jacks on your VCR or other video equipment. A third video input jack (VIDEO 2) is located on the front panel of the TV. These AUDIO/VIDEO input jacks provide better picture quality than the VHF/UHF jack.
6 Y, P_B, P_R/ L(MONO), R	This input connects to the component video Y, P _B , P _R , and AUDIO L(MONO), R jacks on your DVD player or digital set-top box (480i only).
7 AUDIO OUT (VAR/FIX) L(MONO), R	Connects to the AUDIO L(MONO), R input jacks on your audio equipment. You can listen to your TV's audio through your stereo system.

Basic Connections

TV with Indoor or Outdoor Antenna, or CATV Cable

Depending on the cable available in your home, choose one of the connections below:

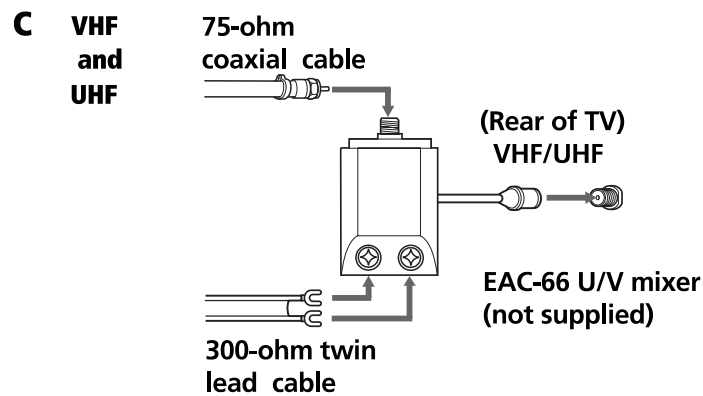
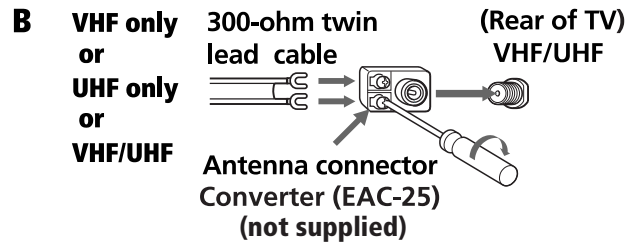
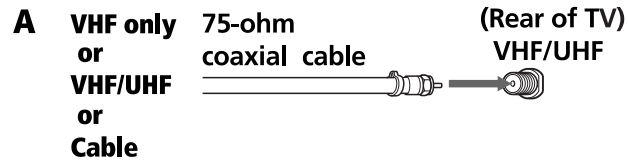

 If you are connecting to an indoor or outdoor antenna, you may need to adjust the orientation of the antenna for best reception.

Cable Box Connections

Some cable TV systems use scrambled or encoded signals that require a cable box to view all channels. If you subscribe to that kind of cable service, use this connection. Scrambled signals coming in to the TV through the cable box cannot be viewed in PIP. If some of your channels are scrambled, consider using the Cable Box and Cable connection.

Cable Box and TV

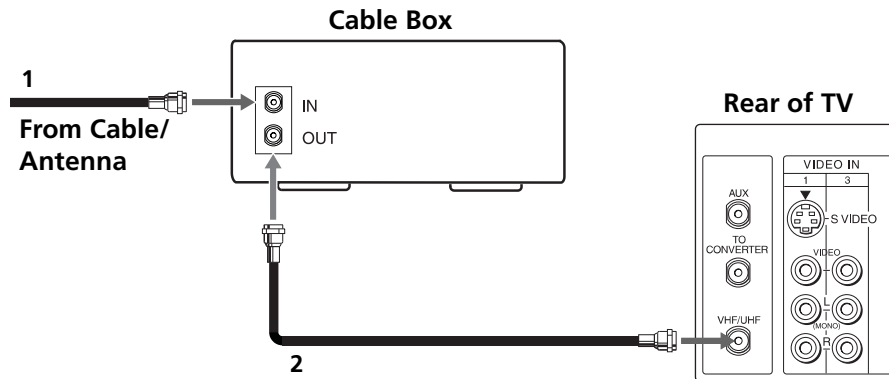

- 1** Connect the coaxial cable from your cable service to the IN jack on your cable box.
- 2** Connect a coaxial cable (not supplied) from the OUT jack on your cable box to the VHF/UHF jack on your TV.

 If you will be controlling all channel selection through your cable box, you should consider using the Channel Fix feature to set your TV to channel 3 or 4 (see page 27).

Cable Box and Cable

Use this connection if you subscribe to a cable system that scrambles some channels (pay channels) but not all of them. This setup allows you to use the remote control to:

- ❑ change channels through your cable box when you are receiving a scrambled signal
- ❑ change channels through your TV

This connection also allows you to use the PIP feature when you are viewing unscrambled channels coming directly into your TV from your cable. Scrambled signals coming through the cable box cannot be viewed in PIP. For more information on the PIP feature, see page 20.

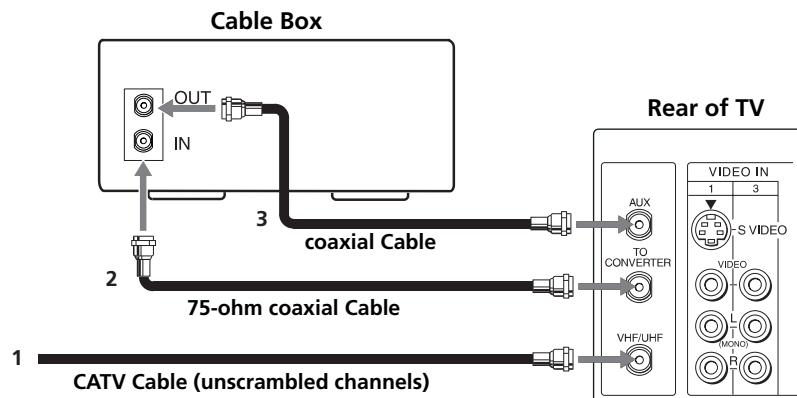

- 1** Connect the coaxial cable from your cable service to the VHF/UHF jack on your TV.
- 2** Using a coaxial cable (not supplied), connect the IN jack on your cable box to the TO CONVERTER jack on your TV.
- 3** Using a coaxial cable (not supplied), connect the OUT jack on your cable box to the AUX jack on your TV.

Press the ANT button on the remote control to switch between the cable box and direct cable inputs.

Your Sony remote control can be programmed to operate your cable box (see page 40).

To use the cable box to change your channels, set your TV to channel 3 or 4. Use the Channel Fix feature to ensure that you don't accidentally switch channels using your TV (see page 27).

Connecting Additional Equipment

Connecting a TV and VCR

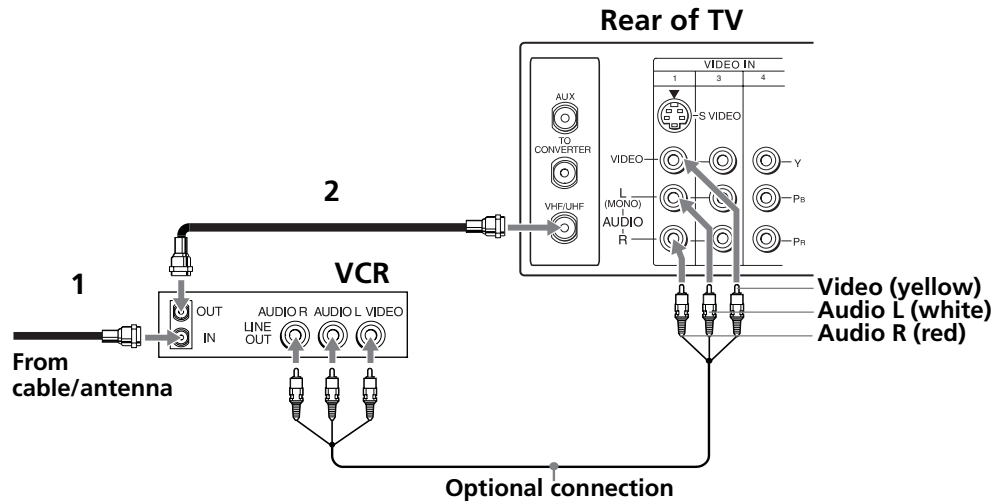

To watch video programs from your VCR, tune your TV to channel 3 or 4 (as set on the rear of your VCR).

- 1** Connect the coaxial cable from your TV antenna or cable service to the IN jack on your VCR.
- 2** Connect a coaxial cable (not supplied) from the OUT jack on your VCR to the VHF/UHF jack on the TV.

Optional connection

If your VCR is equipped with video outputs, you can get better picture quality by connecting audio/video cables (not supplied) from AUDIO/VIDEO OUT on your VCR to AUDIO/VIDEO IN on your TV.

You can use the button to switch between the VHF/UHF and VIDEO inputs.

For better picture quality, use S VIDEO instead of the yellow video cable. S VIDEO does not provide sound; you still must connect the audio cables.

Connecting a TV, VCR, and Cable Box

Use this connection if you subscribe to a cable system that scrambles some channels (pay channels), but not all of them. This setup allows you to use the remote control to:

- change channels through your cable box or VCR when you are receiving a scrambled signal
- change channels through your TV

This connection also allows you to use the PIP feature when you are viewing unscrambled channels coming directly into your TV from your cable. Scrambled signals coming through the cable box cannot be viewed in PIP. For more information on the PIP feature, see page 20.

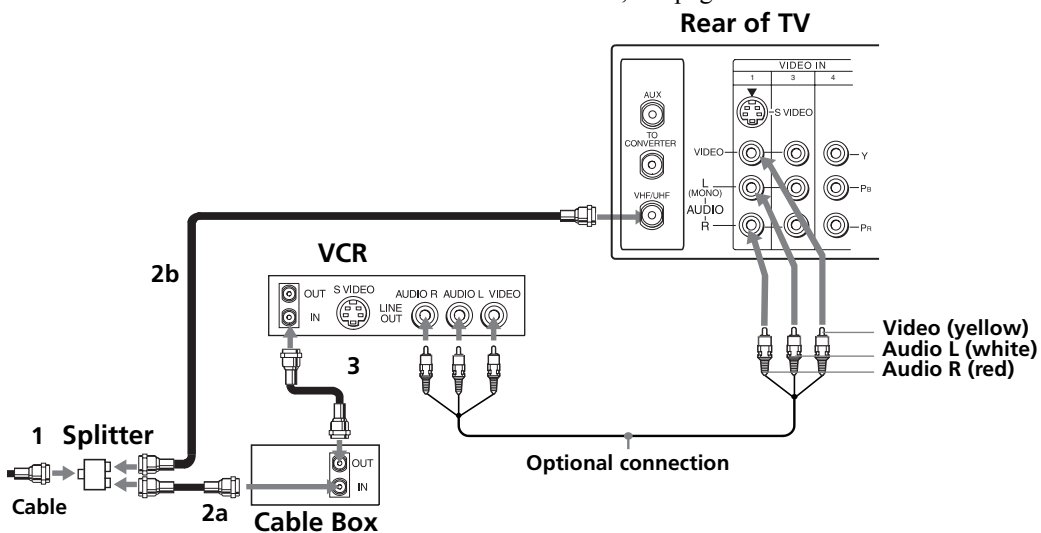

- 1** Connect the single input jack of the splitter to your incoming cable connection.
- 2** Using a coaxial cable (not supplied), connect the two output jacks of the splitter to:
 - a)** the IN jack on your cable box, and
 - b)** the VHF/UHF jack on the TV.
- 3** Using a coaxial cable (not supplied), connect the OUT jack on your cable box to the IN jack on your VCR.

If you will be controlling all channel selections through your cable box, you should consider using the Channel Fix feature to set your TV to channel 3 or 4 (see page 27).

You can use the button to switch between the VHF/UHF and VIDEO inputs.

Operating Instructions

Optional connection



If your VCR is equipped with video outputs, you can get better picture quality by connecting audio/video cables (not supplied) from AUDIO/VIDEO OUT on your VCR to AUDIO/VIDEO IN on your TV.

 For better picture quality, use S VIDEO instead of the yellow video cable. S VIDEO does not provide sound; you still must connect the audio cables.

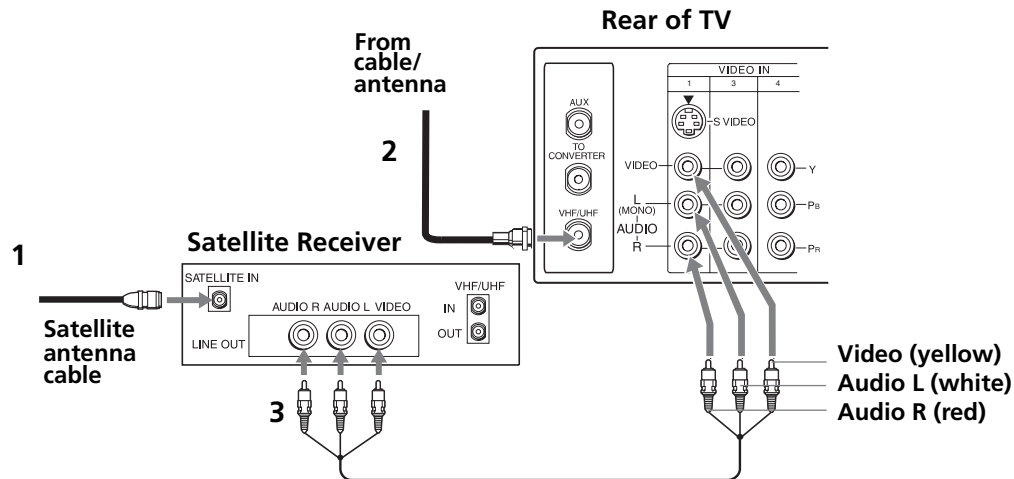
Connecting a TV and Satellite Receiver



- 1** Connect the cable from your satellite antenna to SATELLITE IN on your satellite receiver.
- 2** Connect the coaxial cable from your cable service or antenna to the VHF/UHF jack on your TV.
- 3** Using audio/video cables (not supplied), connect AUDIO/VIDEO OUT on your satellite receiver to AUDIO/VIDEO IN on your TV.

 You can use the  button to switch between the VHF/UHF and VIDEO inputs.

 For better picture quality, use S VIDEO instead of the yellow video cable. S VIDEO does not provide sound; you still must connect the audio cables.

Connecting a TV, Satellite Receiver, and VCR

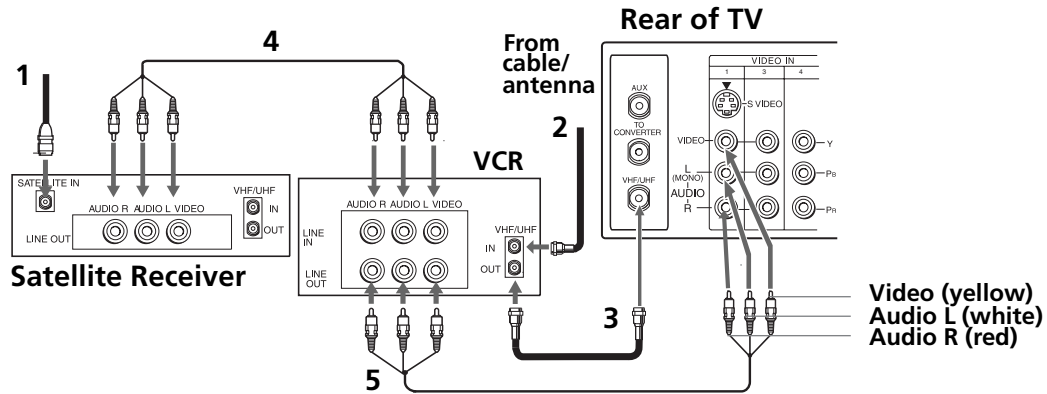

- 1** Connect the coaxial cable from your satellite antenna to SATELLITE IN on the satellite receiver.
- 2** Connect the coaxial cable from your cable service or antenna to the IN jack on your VCR.
- 3** Using a coaxial cable (not supplied), connect the OUT jack on your VCR to the VHF/UHF jack on your TV.
- 4** Using audio/video cables (not supplied), connect AUDIO/VIDEO OUT on your satellite receiver to AUDIO/VIDEO IN on your VCR.
- 5** Using audio/video cables (not supplied), connect AUDIO/VIDEO OUT on your VCR to AUDIO/VIDEO IN on your TV.

 To view from the satellite receiver or VCR, select the video input to which your satellite receiver or VCR is connected by pressing TV/VIDEO on the remote control.

Operating Instructions

Connecting a DVD Player

Using audio/video cables (not supplied), connect AUDIO/VIDEO OUT on your DVD player to AUDIO/VIDEO IN on your TV.

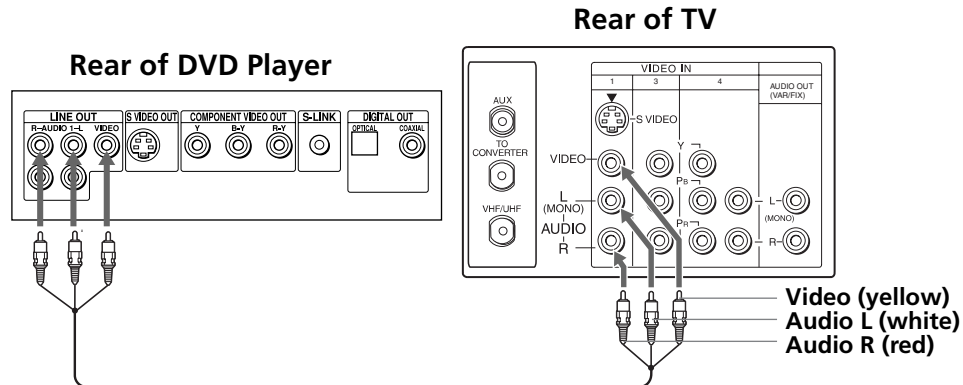

 For better picture quality, use S VIDEO instead of the yellow video cable. S VIDEO does not provide sound; you still must connect the audio cables.

Optional connection

If your DVD player is equipped with component video outputs (Y, P_B, P_R), you can improve the picture quality by using component video cables (480i only).

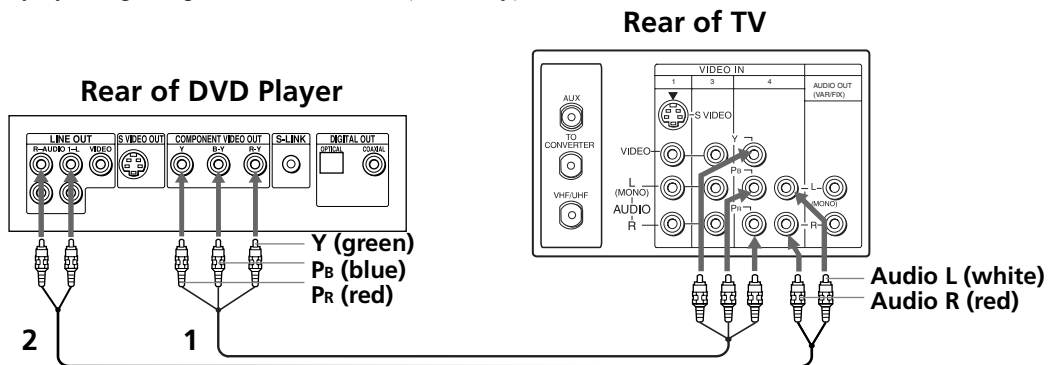

1 Using component video cables (not supplied), connect the Y, P_B, P_R OUT on your DVD player to Y, P_B, P_R IN on your TV.

2 Connect AUDIO OUT on your DVD player to AUDIO IN on your TV.

 The Y, P_B, P_R outputs on your DVD player are sometimes labeled Y, C_B, and C_R or Y, B-Y, and R-Y. If so, connect the cables to like colors.

Connecting a Camcorder

Using audio/video cables (not supplied), connect AUDIO/VIDEO OUT on your camcorder to AUDIO/VIDEO IN on your TV.

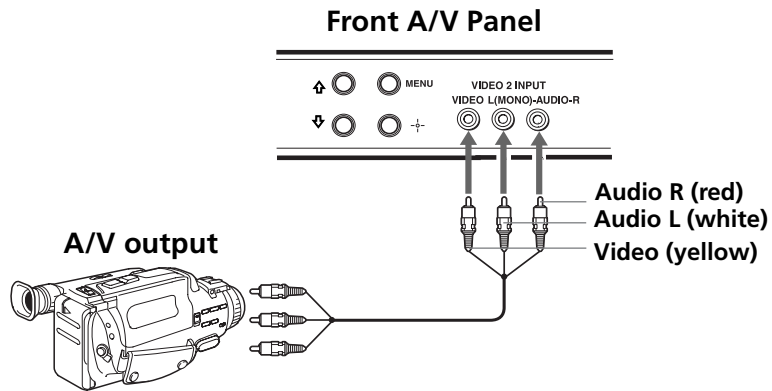

Connecting an Audio System

Using audio cables (not supplied), connect AUDIO OUT on your TV to one of the unused line inputs (e.g. TV, AUX, TAPE2) on your stereo.

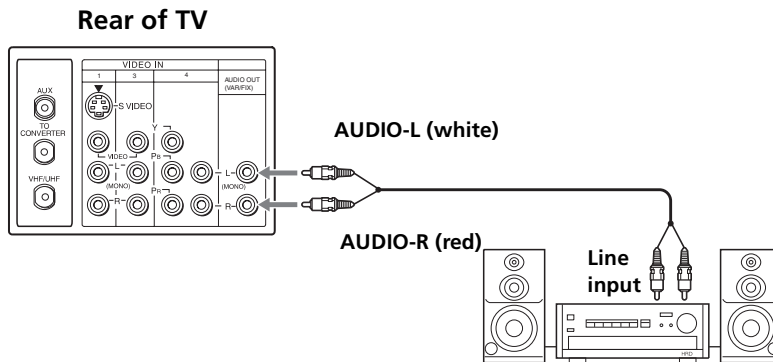

 Set your stereo to the selected line input. See "Using the Audio Menu" on page 25 for additional audio setup instructions.



Using Basic Functions

Setting Up the TV Automatically

After you have finished connecting your TV, you can perform Auto Program to set up your channels. When Auto Programming, the TV will automatically search for available channels and program receivable channels.

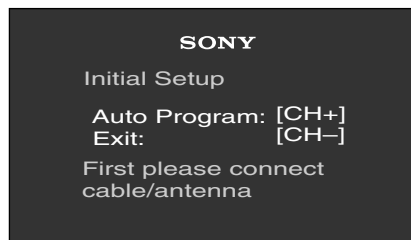









- 1 Press  to turn on the TV. The Initial Setup screen appears.





- 2 Press  on the remote control or on the TV front panel to perform Auto Program, or press  to exit.

 The Initial Setup screen appears each time you turn on the TV until you perform Auto Program.

To perform Auto Program again



- 1 Press .
- 2 Press  to highlight Channel Setup Menu.
- 3 Press  to highlight Cable. Press  to select.
- 4 Press  or  to select On or Off according to how you connected your TV. Press .
- 5 Press  to highlight Auto Program. Press  to search for channels.
- 6 After performing Auto Program, press  to exit.

To reset the TV to factory settings

- 1 Turn the TV on.
- 2 Hold down  on the remote control.
- 3 Press and release the POWER button on the TV front panel. (The TV will turn itself off, then back on.)
- 4 Release .

Quick Start to the Menus

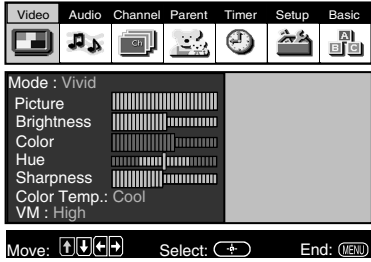
The following settings are available in your on-screen menus. For more details on how to use the menus, see “Using the Menus” on page 23.

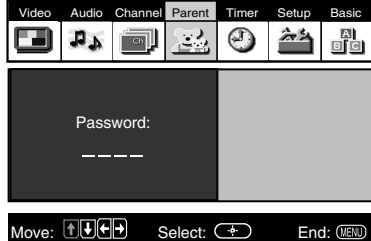
Menu	Allows you to
	Make adjustments to your picture settings.
	Change your audio settings.
	Customize your channel settings.
	Set rating limits on your TV based on program rating or content.

Menu

Allows you to

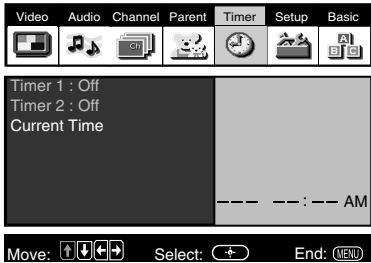

Set the clock on your TV and program scheduled viewing using Timer 1 and Timer 2.



Select closed captioning options, label video inputs, adjust tilt correction, enhance your picture resolution for your DVD (16:9 Enhanced), select menu language, or run a demo of the menus.

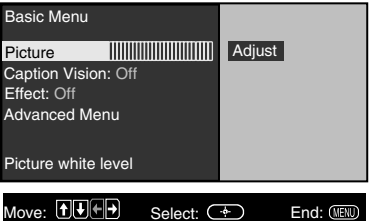
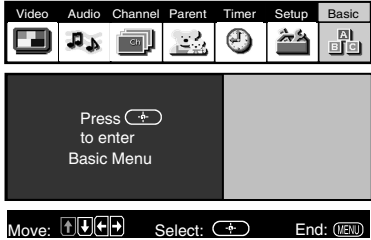

Set the menus to display a simplified menu of most commonly-used menu settings.

Using Picture in Picture (PIP)

The Picture-in-Picture (PIP) feature allows you to view two programs simultaneously, one in the full size “main” picture and one in a small “window” picture.

 The PIP feature is only for the models KV-27FS200, KV-32FS200 and KV-36FS200.

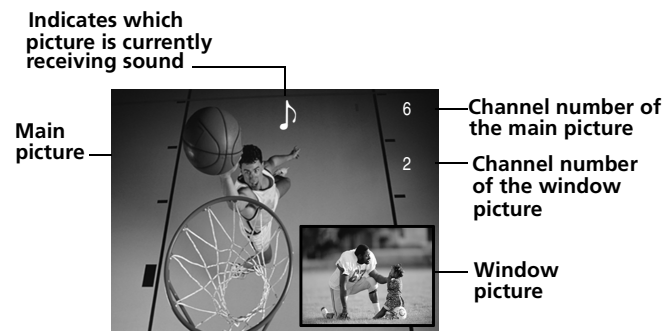

Displaying Picture in Picture



To use PIP









- 1 Press the TV button in the FUNCTION bar to control PIP with the yellow-labeled buttons. Tune your TV to a channel, which you know is currently airing programming.
- 2 Press the  button to display the window picture.
- 3 Use the PIP (yellow) CH +/- buttons to change the channel in the PIP window picture.

To check your PIP

- 1 Press the TV button in the FUNCTION bar to control PIP with the yellow-labeled buttons. Tune your TV to a channel, which you know is currently airing programming.
- 2 Press the  to turn PIP on. Press , the channel from the main window should now appear in the window picture.
- 3 Select the same channel in the main picture (use the CH +/- buttons on the bottom of your remote control). You should now have the same program playing in both windows.
- 4 Use the PIP (yellow) CH +/- buttons to change the channel in the PIP window picture.
- 5 Press the  PIP (yellow) button to switch the PIP window to other video inputs for other equipment that is connected to any of the VIDEO IN jacks of your TV. You should see a different picture in your PIP window for each piece of connected video equipment. Make sure the connected equipment is turned on and working when you perform this test.
- 6 If the PIP feature does not work properly with the TV or the connected video equipment, refer to the troubleshooting section beginning on page 42.

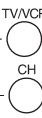
 If you're having problems with PIP, refer to "Setups that affect your ability to use PIP" (page 22) or see Troubleshooting section (page 42) for possible solutions.

PIP Functions buttons

Yellow labeled PIP button	Description
	Press to turn the PIP feature on and off. Press repeatedly to change the window size (1/9, 1/16, Off).
	Press to cycle through the available video equipment you have connected to the TV (in the PIP window picture).
	Press to alternate sound between the main picture and the PIP window picture. The sound symbol  appears for three seconds, indicating whether you are hearing the sound from the main or PIP window picture.
	Press to change the channel in the PIP window picture. To change the channel in the main window, use the main CH +/- buttons at the bottom of the remote control.
	Press to move the location of the window picture to any of the four corners of the screen.
	Press to freeze the window picture. Press again to restore the picture. The main window continues to play as usual.
	Press to switch the main picture with the PIP window picture. Press again to switch back.

 For more information about your remote control, see "Using the Remote Control" on page 3.

To change channels/programs in the PIP window

- Use the yellow PIP CH +/- button to scroll through TV channels.
- Use the yellow TV/VIDEO button to cycle through your other video equipment connected to the TV, such as your VCR, DVD player, or satellite receiver.

Setups that affect your ability to use PIP

 The PIP feature is only for the models KV-27FS200, KV-32FS200 and KV-36FS200.

- ❑ Any video equipment you have connected to the AUX input cannot be viewed in the PIP window.
- ❑ If you are viewing all channels through a cable box, the PIP feature will not work. The cable box only unscrambles one signal at a time, so the window picture will be the same as the main picture.
- ❑ You can use PIP to see pictures from different sources on your TV. For example, you can have a regular (CATV) channel and the output from a VCR, DVD player or satellite receiver on screen at the same time using PIP. To do this:
 - 1** Connect the CATV cable to the VHF/UHF input on the back of the TV.
 - 2** Connect the peripheral (VCR, DVD player or satellite receiver) to any of the VIDEO IN inputs on the back of the TV.
 - 3** Tune to one image in the main picture.
 - 4** Tune to a second image in the PIP window.







You can then SWAP the images on the TV screen.



 You cannot use a signal from the AUX input with PIP.

Using the Menus

This section shows the options available for setting up and adjusting the TV.

How to access menus

- 1** Press  to display the on-screen menu.
- 2** Use the  or  buttons to highlight the desired menu icon. Press  to select it.
- 3** Use the  or  buttons to scroll up and down through the features.
- 4** Follow the instructions on the screen.
- 5** See the specific menu page for instructions on moving through the menu.
- 6** Press  to exit the menu.

 Press  once to display the on-screen menu, and press again to return to normal viewing. If no buttons are pressed, the menu closes automatically after about 90 seconds.

Using the Video Menu



To access the Video menu, refer to the following steps:

To Display



To Select



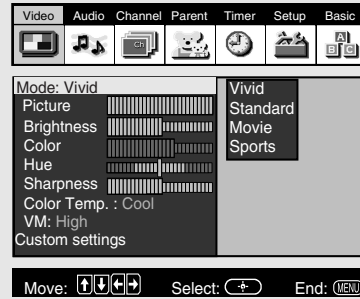

Press  to highlight an option then press .



Mode

Customized picture viewing











Use the  or  buttons to select from one of the following options, then press  to select it.

- Vivid:** Select for enhanced picture contrast and sharpness.
- Standard:** Select for a standard picture.
- Movie:** Select for a finely detailed picture.
- Sports:** Select for a bright picture.





Press  button on the remote control for direct access to the Picture Modes (Vivid, Standard, Movie, Sports).

Picture Controls

- Picture:** Press  to decrease the contrast. Press  to increase contrast.
- Brightness:** Press  to darken the picture. Press  to brighten the picture.
- Color:** Press  to decrease color saturation. Press  to increase color saturation.
- Hue:** Press  to increase the red tones. Press  to increase the green tones.
- Sharpness:** Press  to soften the picture. Press  to sharpen the picture.

Color Temp.



White tint adjustment

Use the  or  buttons to select from one of the following options, then press  to select it.

- Cool:** Gives white colors a blue tint.
- Neutral:** Gives white colors a neutral tint.
- Warm:** Gives white colors a red tint.

VM



Velocity Modulation

Sharpens picture definition to give objects a sharp, clean edge. Use the  or  buttons to select from one of the following options: **High, Low, Off**, then press .







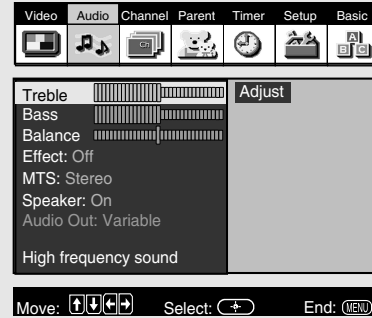

Using the Audio Menu



To access the Audio menu, refer to the following steps:







Press  to highlight an option then press .





Treble	Press  to decrease the higher pitched sound. Press  to increase the higher pitched sound.
Bass	Press  to decrease the lower pitched sound. Press  to increase the lower pitched sound.
Balance	Press  to emphasize the left speaker. Press  to emphasize the right speaker.
Effect	Use the  or  buttons to select from one of the following options, then press  to select it. Surround: Simulates theater quality sound for stereo programs. Off: Normal stereo or mono reception.



 Press  for direct selection of Effect settings (Surround, Off).

MTS <i>Multi-Channel TV Sound</i>	Use the  or  buttons to select from one of the following options, then press  to select it. Stereo: Select when viewing a broadcast in stereo. Auto SAP: Select to have the TV automatically switch to a Second Audio Program (SAP) when a signal is received. Mono: Select to reduce noise in areas of poor reception.
---	--

 Press  button on the remote control for direct access to the MTS settings (Stereo, Auto SAP, Mono).

Speaker <i>Custom selection of audio output source</i>	Use the  or  buttons to select from one of the following options, then press  to select it. On: Select to listen to the sound from the TV speakers with or without a separate stereo system. Off: Select to turn off the TV speakers and listen to the TV's sound only through external audio system speakers.
--	---

Operating Instructions

Audio Out Use the  or  buttons to select from one of the following options, then press  to select it.

Use to control the TV's volume through a stereo

Variable: Adjust the volume through your TV.
Fixed: Adjust the volume through a connected stereo.

 Audio Out settings can only be set when Speaker is set to Off.



 If your TV is set to Auto SAP, some programs may be muted or distorted. If your TV does not output sound, change your Audio MTS setting to Stereo or Mono.

Using the Channel Setup Menu

To access the Channel Setup menu, refer to the following steps:

To Display **To Highlight**  **To Select**















Press  to highlight an option then press .





Favorite Channels

Quick access to favorite channels

- 1 Use the  or  buttons to select the position (1-8) where you want to set a favorite channel, then press .
- 2 Use the  or  buttons to find the channel you want to add to your favorite channels.
- 3 Press  to select the channel. The TV will automatically change to the selected channel.
- 4 Press  to return to the Channel Setup menu or press  to exit.

 To use Favorite Channels: Exit all menus and press . Press  or  to move the cursor to the desired channel number and press .



Cable

Use the  or  buttons to select from one of the following options, then press  to select it.

- On:** Select if you are receiving cable channels with a CATV cable.
Off: Select if you are using a TV antenna.

 After changing your cable settings, you will need to perform Auto Program.

Channel Fix

Use the  or  buttons to select from one of the following options, then press  to select it.

- Off:** Channel Fix is not set.
- 2-6:** Select when you want to control all channel selection through a cable box or VCR. Select the appropriate channel (usually 3 or 4) and use the cable box's or VCR's remote control for channel selection.
- AUX 2-6:** Use this setting instead of the **2-6** if you want to change channels using a cable box, VCR or satellite receiver and you've connected it to the AUX input (KV-27FS200, KV-32FS200, KV-36FS200 only).
- Video 1:** Select from available video inputs when you have connected video equipment (e.g. satellite receiver) and you want your TV fixed to it.

Operating Instructions

Auto Program Perform Auto Program whenever setting up your TV.
Auto Program will search for available channels and program receivable channels.

Channel Skip/Add Use this feature after you run Auto Program to skip unwanted channels or add new ones.

- 1 Use the \uparrow or \downarrow buttons to select the position of the desired channel, then press \ominus .
- 2 Use the \uparrow or \downarrow buttons to select Skip or Add, then press \ominus .
- 3 Press \leftarrow to return to the Channel Setup menu or press MENU \ominus to exit.

 Pressing CH + or CH - will skip over channels that have been skipped. You can still use the 0-9 buttons to directly tune to skipped channels.

Channel Label 1 Press \ominus , then use the \uparrow or \downarrow buttons until you reach the desired channel number.

Label up to 40 channels with their call letters

- 2 Press \ominus to activate the channel.
- 3 Press \downarrow to highlight "Label", then press \ominus . Use the \uparrow or \downarrow buttons to display the first call letter or number of the caption. Press \ominus to select. Repeat this process until you finish selecting all the call letters.
- 4 When finished, press \ominus to activate.
- 5 Press \leftarrow to return to the Channel Setup menu or press MENU \ominus to exit.

 You cannot use Favorite Channels, Cable, Channel Skip/Add, and Channel Label when Channel Fix is set.

Using the Parent Menu

To access the Parent menu, refer to the following steps:

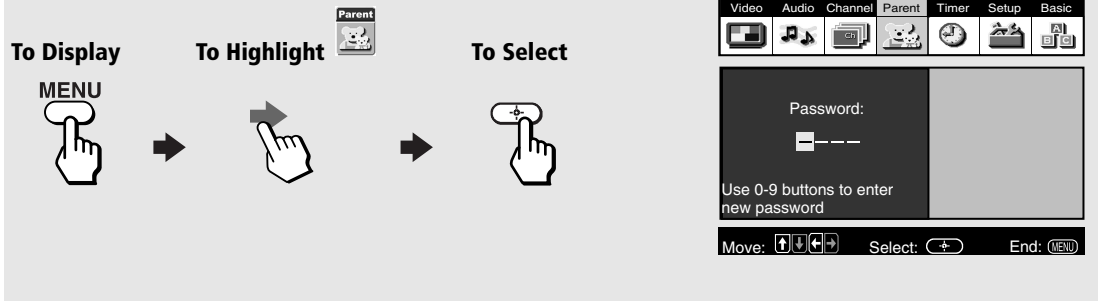

The diagram illustrates the three steps to access the Parent menu:

- To Display:** Press the **MENU** button.
- To Highlight:** Press the **Right Arrow** key.
- To Select:** Press the **Right Arrow** key.

The screenshot shows the Parent menu interface with the following elements:

- Top navigation bar: Video, Audio, Channel, Parent, Timer, Setup, Basic.
- Current menu: Password.
- Input field: A box with four dashes (----) for entering a password.
- Instruction: "Use 0-9 buttons to enter new password".
- Bottom navigation bar: Move (Up, Down, Left, Right arrows), Select (Right arrow), End (MENU).

The Parental Control feature is designed to help parents monitor what their children watch on television.

To use the Parent Menu

In Parent menu, you will be asked to set a 4-digit password for any further access into Parent menu.

- 1** Use the **0-9** buttons to enter a 4-digit password.
- 2** Confirm your password by entering it again.

 Keep this manual in a safe place. You need your password for any future access to the Parental Control menu. If you forget your password, see page 44.

Once your password is set correctly, the Parent menu appears.

Parental Control

Setting the Rating

You can change the Rating by selecting one of the Parental Lock options.



- 1 Press \downarrow to highlight Parental Lock, press \rightarrow .

If you are not familiar with Parental Guideline rating system, use one of the following preset categories to simplify the rating selection: Child, Youth, Young Adult.

- 2 Use the \uparrow or \downarrow to select the desired rating and press \rightarrow .

Rating	TV will allow a maximum rating of
Child	TV-Y, TV-G, G (U.S.), G, C (Canada)
Youth	TV-PG, PG (U.S.), 8 ans + (Canada)
Young Adult	TV-14, PG-13 (U.S.), 14+ (Canada)
Custom	Select to set more restrictive ratings (see next section)
Off	No rating limit

Changing your Password

- 1 Use the \uparrow or \downarrow buttons to select Change Password and press \rightarrow .
- 2 Follow steps 1 and 2 for “Using the Parent Menu” on page 29.



Select a Country

Select U.S.A. to use US ratings (see pages 32-33) or select Canada to use Canadian ratings (see page 34). If you select a Country (U.S.A. or Canada) that is not where you live, the rating you select will not be activated.

- 1 Press \downarrow to highlight Country, press \rightarrow .
- 2 Use the \uparrow or \downarrow to select the desired country and press \rightarrow .

Information for Parents

To view a program that exceeds the TV rating

- Press , then use the  buttons to enter your password.

 Entering your password to view a blocked program will temporarily turn Lock to Off. To reactivate your Lock settings, turn the TV off then back on; the TV will return to the settings that you have selected.

Using the Custom Menu

Follow the instructions on the screen to make your custom settings. Select the country desired for your TV's rating limit. See page 32 for U.S. models and page 34 for Canadian models for more information.

 Once you have blocked a rating or content, all higher ratings or content will be automatically blocked.

United States: Selecting Custom Rating Options

For the United States, the Custom Rating Menu includes the following options: Movie Rating, TV Rating and Unrated. (For Canada, see page 34.)

Movie Rating

This system defines the rating levels of movies shown in theaters and on prime cable channels.

Rating	Defined as
G	General audience
PG	Parental Guidance suggested
PG-13	Parents strongly cautioned
R	Restricted
NC-17	No one 17 and under admitted
X	Adult audience only



TV Rating

The TV rating is divided into two groups: age-based and content-based.

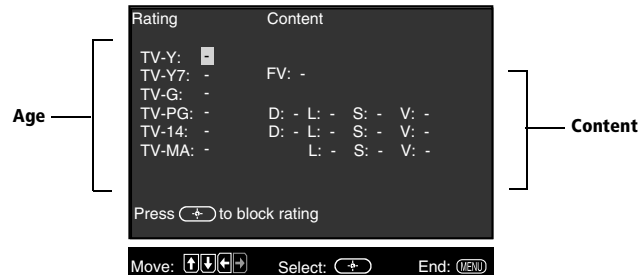

Age	Defined as
TV-Y	All children
TV-Y7	Directed to older children
TV-G	General audience
TV-PG	Parental Guidance suggested
TV-14	Parents strongly cautioned
TV-MA	Mature Audience only

Content	Defined as
FV	Fantasy Violence
D	Suggestive dialogue
L	Strong language
S	Sexual situations
V	Violence

The content ratings will increase depending on the level of the age-based rating. For example, a program with a TV-PG V (Violence) rating may contain moderate violence, while a TV-14 V (Violence) rating may contain intense violence.

Unrated

You have the option of blocking TV programs or movies that are not rated.

Allow	Allows all unrated programs
Block	Blocks all unrated programs



 If you choose to block unrated TV programs, please be aware that the following programs may be blocked: emergency broadcasts, political programs, sports, news, public service announcements, religious programs and weather.

Canada: Selecting Custom Rating Options

For Canada, the Custom Rating Menu includes the following options: English Rating, French Rating and U.S.A. Rating.

English Rating

These ratings are for Canadian programs that are broadcast in English.

Rating	Defined as
C	Children
C8+	Children 8 years and older
G	General programming
PG	Parental Guidance
14+	Viewers 14 and older
18+	Adult programming

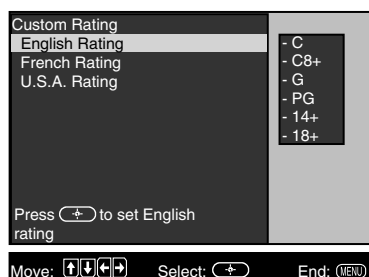

French Rating

These ratings are for Canadian programs that are broadcast in French.

Rating	Defined as
G	General
8 ans+	Not recommended for younger children
13 ans+	Not recommended for children under age 13
16 ans+	Not recommended for ages under 16
18 ans+	This program is restricted to adults

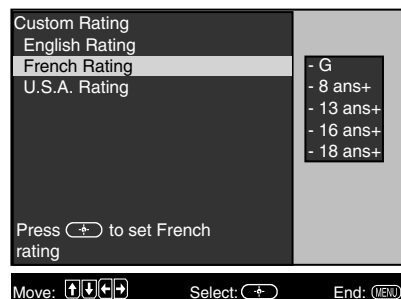

U.S.A. Rating

For programs from the United States, please see “TV Rating” on page 32.

Using the Timer Menu

To access the Timer menu, refer to the following steps:

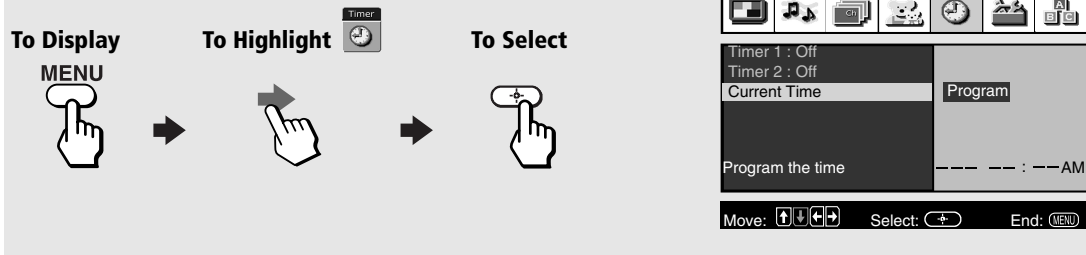

- Current Time** Set your TV to the current day and time. Press **+** to open Current Time menu:
- 1 Use the **↑** or **↓** buttons to enter the correct day and time, then press **+**.
 - 2 Press **MENU** to exit the menu.

 You must set the Current Time before you can use Timer 1 or Timer 2.

- Timer 1 and Timer 2** Use the timers to program your TV to turn on and off by day, time, duration and channel. The timers duration is maximum of 6 hours. When the channel is fixed, it is not necessary to set the channel.
- Scheduled viewing*
- 1 Use the **↑** or **↓** buttons to select Timer 1 or Timer 2, then press **+**.
 - 2 Use the **↑** or **↓** buttons to enter the desired day, start time, duration, and channel, then press **+**. The timer status should be On when the Timer has been set, and the timer light on the front panel of the TV should be turned on.
 - 3 Press **MENU** to exit the menu.



 Select Off to turn off the Timer (your previous settings will be saved).

 When you perform Auto Program, Timer 1 and Timer 2 settings will be cleared. Also, in the event of any loss of power, Current Time, Timer 1 and Timer 2 settings will be cleared.

Using the Setup Menu

To access the Setup menu, refer to the following steps:





Press  to highlight an option then press .



Caption Vision

Closed-Captioning

Allows you to select from three closed caption modes (for programs that are broadcast with closed captioning).

Use the  or  buttons to select from one of the following options, then press  to select it.

Off: Caption Vision is not activated.

CC1, 2, 3, 4: Displays printed dialogue and sound effects of a program.



Text1, 2, 3, 4: Displays network/station information.



Info: Displays the name of the current program and its remaining time, if available.



Video Label

Label connected equipment

Allows you to identify the audio/video components connected to the TV: VCR, DVD, etc. When you press TV/VIDEO to switch inputs, the Video Label will display on-screen.



1 Press  or  buttons to access the input you want to label and press .

2 Press  or  buttons to choose a label and press .

3 Press  to return to Setup menu or press  to exit.



 If you select "Skip", your TV skips this connection when you press the TV/VIDEO button.

Tilt Correction

Use the  or  buttons to correct any tilt of the picture from -5 to +5, then press  to activate.

Language

Display all menus in the language of your choice.

Use the  or  buttons to select from one of the following options: English, Español (Spanish) and Français (French). Then press .

16:9 Enhanced

Provides enhanced picture resolution for wide-screen sources such as DVD (only available when the TV is in Video mode).

Demo

Press  to run a demonstration of the on-screen menus.

 You can press any key to exit Demo mode.

Using the Basic Menu

To access the Basic menu, refer to the following steps:

To Display





To Highlight



To Select



Press  to highlight an option then press .

Basic Menu





Picture  Adjust

Caption Vision: Off

Effect: Off







Advanced Menu





Picture white level

Move:    

Select: 

End: 







Picture	Press  to decrease picture contrast.
<i>Picture contrast</i>	Use the  to increase picture contrast.
Caption Vision	In the Basic menu, Caption Vision options are Off and the last captioning option selected (CC1-4, Text1-4, or Info).
<i>Closed-Captioning</i>	
Effect	Use the  or  buttons to select one of the following options, then press  to select it.
Surround:	Simulates theater quality sound for stereo programs.
Off:	Normal stereo or mono reception.
Advanced Menu	Press  to return to the advanced menus.

 If you use the  button to close the Basic menu, only the Basic menu appears when you press  again. To access the other menus, press  to highlight Advanced Menu, then press .

Other Information

Programming the Remote Control

You can use the supplied remote control to operate Sony or non-Sony video equipment.

- 1 Press .
- 2 Press  or  (FUNCTION).
- 3 Use the - buttons to key in the code number from the following chart.
- 4 Press .

VCR codes

Sony	301, 302, 303	JCPenney	309, 305, 304, 330, 314, 336, 337
Admiral (M. Ward)	327	JVC	314, 336, 337, 345, 346, 347
Aiwa	338, 344	Kenwood	314, 336, 332, 337
Audio Dynamic	314, 337	LXI (Sears)	332, 305, 330, 335, 338
Broksonic	319, 317	Magnavox	308, 309, 310
Canon	309, 308	Marantz	314, 336, 337
Citizen	332	Marta	332
Craig	302, 332	Memorex	309, 335
Criterion	315	Minolta	305, 304
Curtis Mathis	304, 338, 309	Mitsubishi/MGA	323, 324, 325, 326
Daewoo	341, 312, 309	Multitech	325, 338, 321
DBX	314, 336, 337	NEC	314, 336, 337
Dimensia	304	Olympic	309, 308
Emerson	319, 320, 316, 317, 318, 341	Optimus	327
Fisher	330, 335	Panasonic	308, 309, 306, 307
Funai	338	Pentax	305, 304
General Electric	329, 304, 309	Philco	308, 309
Go Video	322, 339, 340	Philips	308, 309, 310
Goldstar	332	Pioneer	308
Hitachi	306, 304, 305, 338	Quasar	308, 309, 306
Instant Replay	309, 308	RCA/PROSCAN	304, 305, 308, 309, 311, 312, 313, 310, 329
Realistic	309, 330, 328, 335, 324, 338	Symphonic	338
Samsung	322, 313, 321	Tashiro	332
Sansui	314	Tatung	314, 336, 337
Sanyo	330, 335	Teac	314, 336, 338, 337

Operating Instructions

VCR codes

Scott	312, 313, 321, 335, 323, 324, 325, 326	Technics	309, 308
Sharp	327, 328	Toshiba	312, 311
Shintom	315	Wards	327, 328, 335, 331, 332
Signature 2000 (M. Ward)	338, 327	Yamaha	314, 330, 336, 337
SV2000	338	Zenith	331
Sylvania	308, 309, 338, 310		

Cable box codes

Sony	230
Hamlin/Regal	222, 223, 224, 225, 226
Jerrold/G. I.	201, 202, 203, 204, 205, 206, 207, 208, 218
Oak	227, 228, 229
Panasonic	219, 220, 221
Pioneer	214, 215
Scientific Atlanta	209, 210, 211
Tocom	216, 217
Zenith	212, 213

Laser Disc Player codes

Sony	701
Panasonic	704, 710
Pioneer	702

DBS codes

DIRECTV	809
Echostar/Dish Network	810

Satellite receiver codes

Sony	801
General Electric	802
Hitachi	805
Hughes	804
Panasonic	803
RCA/PROSCAN	802, 808
Toshiba	806, 807

DVD Player codes









Sony	751
JVC	756
Mitsubishi	761
Onkyo	762
Oritron	759
Panasonic	753
Philips/ Magnavox	757
Pioneer	752
RCA	755
Samsung/Hitachi	758
Toshiba	754
Zenith	760

 If more than one code number is listed, try entering them one by one until you come to the correct code for your equipment.



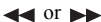





 Whenever you remove the batteries, the code numbers may revert to the factory setting and must be reset.

 In some rare cases, you may not be able to operate your equipment with the supplied remote control. In this case, use the equipment's supplied remote control.



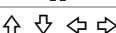

Operating a VCR

Press	To
	Power on the VCR
	Select channels directly
	Change channels
	Play video tape
	Stop
	Search forward or backward
	Pause
	Record
	Change between VCR and TV inputs

Operating a DVD



Press	To
	Power on the DVD
	Select chapters directly
	Search chapters forward or backward
	Play DVD
	Stop
	Pause
	Move the cursor in the menu
	Display the DVD menu



Operating a Laser Disc

Press	To
	Power on the laser disc
	Search chapters forward or backward
	Play disc
	Stop
	Pause

Troubleshooting

If you are having a problem with your TV, try the suggestions below. If the problem persists, contact your nearest Sony Dealer.

Problem	Possible Solutions
Reset the TV to factory settings	<ul style="list-style-type: none">❑ Turn on the TV. While holding down the RESET button on the remote control, press POWER button on the TV front panel. (The TV will turn itself off, then back on again.) Release the RESET button.
No picture, no sound	<ul style="list-style-type: none">❑ Make sure the power cord is plugged in.❑ If a red light is flashing on the front of your TV for more than a few minutes, disconnect and reconnect the power cord to restore the TV. If the problem continues, call your local service center.❑ Check the TV/VIDEO setting: when watching TV, set to TV; when watching video equipment, set to VIDEO 1, 2, 3 or 4 (page 4).❑ Make sure the batteries have been inserted correctly into the remote control (page 2).❑ Try another channel to rule out station trouble.
Poor or no picture, good sound	<ul style="list-style-type: none">❑ Adjust the Picture setting in the Video menu (page 24).❑ Adjust the Brightness setting in the Video menu (page 24).❑ Check the antenna and/or cable connections (page 7).
Good picture, no sound	<ul style="list-style-type: none">❑ Press  so that Muting disappears from the screen (page 3).❑ Check your Audio settings. Your TV may be set to Auto SAP in the MTS feature (page 25).❑ Make sure the Speaker option is set to On in the Audio Menu (page 25).❑ Press  to adjust your TV's volume, it's probably very low.
No color	<ul style="list-style-type: none">❑ Adjust the Color setting in the Video menu (page 24).
Only snow appears on the screen	<ul style="list-style-type: none">❑ Check the Cable setting in the Channel Setup menu (page 27).❑ Check the antenna and/or cable connections (page 7).❑ Make sure the channel selected is currently broadcasting.
Dotted lines or stripes	<ul style="list-style-type: none">❑ Adjust the antenna.❑ Move the TV away from other electronic equipment. Some electronic equipment creates electrical noise, which can interfere with TV reception.
Double images or ghosts	<ul style="list-style-type: none">❑ Check your outdoor antenna or call your cable service.
Cannot receive higher number channels (UHF) when using an antenna	<ul style="list-style-type: none">❑ Make sure Cable is set to Off in the Channel Setup menu (page 27).❑ Perform Auto Program to add channels that are not presently in the memory (page 17).

Problem	Possible Solutions
Cable stations don't seem to work	<ul style="list-style-type: none"> <input type="checkbox"/> Make sure Cable is set to On in the Channel Setup menu (page 27). <input type="checkbox"/> Perform Auto Program to add channels that are not presently in the memory (page 17).
Remote control does not operate	<ul style="list-style-type: none"> <input type="checkbox"/> Press TV (FUNCTION) when operating your TV. <input type="checkbox"/> Check the orientation of the batteries. <input type="checkbox"/> Batteries could be weak. Replace them (page 2). <input type="checkbox"/> Move the TV three to four feet away from fluorescent lights.
Cannot change channels with the remote control	<ul style="list-style-type: none"> <input type="checkbox"/> Make sure you have not inadvertently switched your TV from the channel 3 or 4 setting if you are using another device to change channels. <input type="checkbox"/> If you are using another device to control channels, be sure that you have pressed the FUNCTION button for that device. For example, if you are using your VCR to control channels, be sure to press the VCR/DVD FUNCTION buttons (page 4).
Cannot access other menus when using the Basic menu	<ul style="list-style-type: none"> <input type="checkbox"/> If you use the  button to close the Basic menu, only the Basic menu appears when you press  again. To access the other menus, select the Advanced Menu option (page 37).
The remote control doesn't work in PIP mode	<ul style="list-style-type: none"> <input type="checkbox"/> Press the TV FUNCTION button. You may have inadvertently pressed the VCR/DVD FUNCTION button, which changes the PIP buttons to VCR mode (page 21).
There is no window picture or it is just static	<ul style="list-style-type: none"> <input type="checkbox"/> Be sure your PIP window picture is set to a video source/channel that has a program airing. <input type="checkbox"/> You may be tuned to a video input with nothing connected to it. Try cycling through your video inputs using the yellow PIP TV/VIDEO button with the red dot (page 21).
I get the same program in the window picture as in the main picture	<ul style="list-style-type: none"> <input type="checkbox"/> Both may be set to the same channel. Try changing channels in either the main picture or the window picture (page 21). <input type="checkbox"/> Your TV may be set up to select all your channels through a cable box. The cable box will only unscramble one signal at a time, so you cannot use the PIP feature. If possible, run a direct cable to the VHF/UHF jack on your TV. This will only work if your cable system provides an unscrambled signal (page 9).
I cannot get anything but TV	<ul style="list-style-type: none"> <input type="checkbox"/> Be sure that you did not set the video label in the Setup menu (page 36) to skip your video inputs. If a video input has been set to "Skip", it will be skipped when pressing the TV/Video buttons for either the main or PIP pictures.
The TV needs to be cleaned	<ul style="list-style-type: none"> <input type="checkbox"/> Clean the TV with a soft dry cloth. Never use strong solvents such as thinner or benzine, which might damage the finish of the cabinet.

Operating Instructions

Problem	Possible Solutions
Lost password for Parental Control	<input type="checkbox"/> In the password screen, enter the following master password: 4357. After using the master password, you must create a new password. The master password cannot be used to unlock currently blocked channels.
You lost your remote control	<input type="checkbox"/> You can use the front panel controls to access your menus, change channels, adjust the volume or change video inputs (page 2). Contact your nearest Sony Dealer to order a replacement, please call our Sony Direct Accessory and Part Center at 1-800-488-7669 (U.S. residents only).
There is a black box on the screen	<input type="checkbox"/> You have selected a text option in the Setup menu (page 36) and no text is available. To turn off this feature, select Off in the Caption Vision option. If you were trying to select closed captioning, select CC1-4 instead of Text1-4.
TV doesn't turn on after disconnecting the TV and timer LED flashes	<input type="checkbox"/> Press the POWER button on your remote control or in the TV front panel, one more time.

If, after reading these Operating Instructions, you have additional questions related to the use of your Sony television, please call our Customer Information Services Center at 1-800-222-SONY (7669) (U.S. residents only) or (416) 499-SONY (7669) (Canadian residents only).

Specifications

For all models (except as noted)

Television system	American TV standard/NTSC
Channel coverage	VHF: 2-13/UHF: 14-69/CATV: 1-125
Antenna	75-ohm external antenna terminal for VHF/UHF
Picture tube	FD Trinitron® tube
Power requirements	120V, 60 Hz
Supplied Accessories	Size AA (R6) batteries (2) Remote Control RM-Y180 (1) (KV-27FS100, KV-32FS100, KV-36FS100) Remote Control RM-Y181 (1) (KV-27FS200, KV-32FS200, KV-36FS200)
Optional Accessories	Connecting cables VMC-810S/820S, VMC-720M, YC-YC-15V/30V, RK74A EAC-66U/V mixer TV Stand: SU-27FS1 for KV-27FS100 and KV-27FS200 SU-32FS1 for KV-32FS100 and KV-32FS200 SU-36FS1 for KV-36FS100 and KV-36FS200

KV-27FS100, KV-27FS200

Screen size	Visible screen size: 679 mm (27 inches) measured diagonally Actual screen size: 736.6 mm (29 inches) measured diagonally		
Inputs/outputs	Inputs	1 video, 1 audio (front) 2 video, 2 audio (rear) 1 S VIDEO 1 RF (KV-27FS100) 2 RF (KV-27FS200) 1 Y, PB,PR, 1 audio	Outputs 1 AUDIO OUT
Speaker output	10 W x 2		
Power Consumption	180 W in use 1 W in stand by (KV-27FS100) 185 W in use 1 W in stand by (KV-27FS200)		
Dimensions (W/H/D)	768 x 589 x 497 mm (30 ¹ / ₄ x 23 ¹ / ₄ x 19 ⁵ / ₈ inches)		
Mass	49.5 kg (109 lbs. 2 oz.)		

KV-32FS100, KV-32FS200

Screen size	Visible screen size: 803 mm (32 inches) measured diagonally Actual screen size: 863.6 mm (34 inches) measured diagonally		
Inputs/outputs	Inputs	1 video, 1 audio (front) 2 video, 2 audio (rear) 1 S VIDEO 1 RF (KV-32FS100) 2 RF (KV-32FS200) 1 Y, PB,PR, 1 audio	Outputs 1 AUDIO OUT
Speaker output	10 W x 2		
Power Consumption	190 W in use 1 W in stand by (KV-32FS100) 195 W in use 1 W in stand by (KV-32FS200)		
Dimensions (W/H/D)	898 x 696 x 576 mm (35 ³ / ₈ x 27 ³ / ₈ x 22 ⁵ / ₈ inches)		
Mass	75 kg (165 lbs. 6 oz.)		

Operating Instructions

KV-36FS100, KV36FS200

Screen size	Visible screen size: 911 mm (36 inches) measured diagonally Actual screen size: 965.2 mm (38 inches) measured diagonally	
Inputs/outputs	Inputs	Outputs
	1 video, 1 audio (front)	1 AUDIO OUT
	2 video, 2 audio (rear)	
	1 S VIDEO	
	1 RF (KV-36FS100)	
	2 RF (KV-36FS200)	
	1 Y, PB, PR, 1 audio	
Speaker output	10 W x 2	
Power Consumption	190 W in use 1 W in stand by (KV-36FS100) 195 W in use 1 W in stand by (KV-36FS200)	
Dimensions (W/H/D)	985 x 774 x 633 mm (38 ³ / ₄ x 30 ¹ / ₂ x 25 inches)	
Mass	98.4 kg (216 lbs. 8 oz.)	

Design and specifications are subject to change without notice.

Index

- 16:9 Enhanced **36**
- A**
 - Audio Out **26**
 - Auto Program **17, 28**
 - Auto SAP **25**
- B**
 - Balance **25**
 - Bass **25**
 - Batteries
 - Inserting in remote **2**
 - Brightness **24**
- C**
 - Cable **27**
 - Caption Vision **36**
 - Channel Fix **27**
 - Channel Label **28**
 - Channel Skip/Add **28**
 - Color **24**
 - Color Temperature **24**
 - Connections
 - Cable and antenna **7**
 - Cable Box and Cable **9**
 - Connecting a Camcorder **15**
 - Connecting a DVD Player **14**
 - Connecting an Audio System **15**
 - TV and Cable Box **8**
 - TV and Satellite Receiver **12**
 - TV and VCR **10**
 - TV, Satellite Receiver and VCR **13**
 - TV, VCR and Cable Box **11**
 - Current Time **35**
- D**
 - Demo **36**
 - DISPLAY **4**
- E**
 - Effect
 - Off **25**
 - Surround **25**
- F**
 - Favorite Channels **27**
- H**
 - Hue **24**
- L**
 - Language **36**
- M**
 - Menus
 - Audio **25**
 - Basic **37**
 - Channel Setup **27**
 - Parent **29**
 - Setup **36**
 - Timer **35**
 - Video **24**
 - Mode
 - Movie **24**
 - Sports **24**
 - Standard **24**
 - Vivid **24**
 - MTS
 - Auto SAP **25**
 - Mono **25**
 - Stereo **25**
- P**
 - Parental Control **30**
 - Picture **24, 37**
 - Picture in Picture (PIP) **20**
- R**
 - Ratings
 - English Rating **34**
 - French Rating **34**
 - Movie Rating **32**
 - TV Rating **32**
 - U.S.A. Rating **34**
 - Unrated **33**
 - Remote Control
 - Batteries **2**
 - Programming **39**
 - Using **3, 4**
- S**
 - Setting the Rating **30**
 - Sharpness **24**
 - SLEEP **3**
 - Speaker **25**
 - Specifications **45**

T

- Tilt Correction **36**
- Timer 1 and Timer 2 **35**
- Treble **25**
- Troubleshooting **42**
- TV Features **1**
- TV Front Panel **2**
- TV Rear Panel **5**

V

- V-Chip (see Parental Control)
- Video Label **36**
- VM **24**

Sony Corporation

Printed in U.S.A.