

SAMSUNG

COLOUR TELEVISION

14F2/14F3/14H4/14H5/14S1/14S4/14V5/3366

15K2/15K5/15K8/15K9/15K10/15M16

17A11/17K10

20F3/20H4/20H5/20S1/20S4/20S5/20V5/5038

21A3/21A6/21A7/21A8/21B6/21D8/21F3/21F5

21H4/21H5/21K2/21K3/21K5/21K9/21K10/21M16

21S1/21S4/21V5

Owner's Instructions

Before operating the unit,
please read this manual thoroughly,
and retain it for future reference.

REMOTE CONTROL
ON-SCREEN MENUS
TELETEXT FUNCTION (depending on the model)

Safety Instructions

ENG

The following illustrations represent the precautions to be taken when using and moving your television.

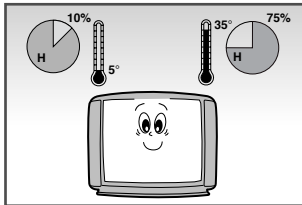

Do NOT expose the television to extreme temperature conditions (below 5°C and above 35°C) or to extreme humidity conditions (less than 10% and more than 75%).

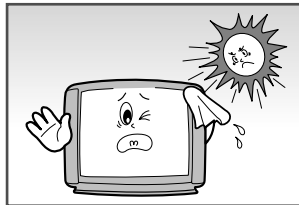

Do NOT expose the television to direct sunlight.

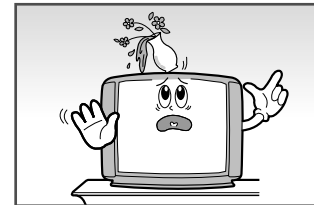

Do NOT expose the television to any liquids.

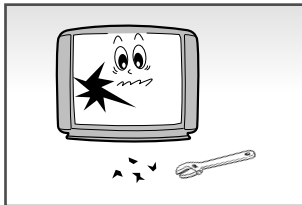

If the television is broken, do not try to repair it yourself. Contact qualified service personnel.



During a storm conditions (especially when there is lightning) unplug the television from the mains socket and aerial.

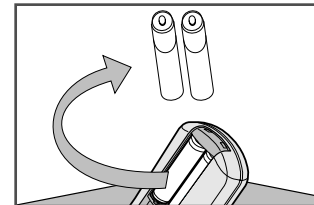

If the remote control is not used for a long period of time, remove the batteries and store it in a cool, dry place.

THIS DEVICE IS NOT FOR USE IN INDUSTRIAL ENVIRONMENTS

➤ Please use a soft and dry cloth (not containing volatile matter) when you clean the TV.

Caution

CAUTION

RISK OF ELECTRIC SHOCK

DO NOT OPEN

CAUTION: TO PREVENT ELECTRICAL SHOCK, DO NOT REMOVE REAR COVER, NO USER SERVICEABLE PARTS INSIDE. REFER SERVICING TO QUALIFIED SERVICE PERSONNEL.

The lightning flash and arrow head within the triangle is a warning sign alerting you of "dangerous voltage" inside the product.

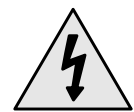

The exclamation point within the triangle is a warning sign alerting you of important instructions accompanying the product.



WARNING: TO PREVENT DAMAGE WHICH MAY RESULT IN FIRE OR SHOCK HAZARD. DO NOT EXPOSE THIS APPLIANCE TO RAIN OR MOISTURE.

The main voltage is indicated on the rear of the TV set and the frequency is 50 or 60Hz.

Mode	System
CS	PAL-B/G, D/K, I, SECAM-B/G, D/K, I, NTSC4.43 (NTSC3.58; option)
CB	PAL-B/G
CD	PAL-D/K

Contents

◆ PREPARING YOUR TELEVISION	
■ Safety Instructions	2
■ Caution	2
■ Front Panel Controls.....	4
■ Using the Buttons on the Front Panel.....	4
■ Connection Panels	5
■ Infrared Remote Control (All Functions Except Teletext)	6
■ Infrared Remote Control (Teletext Functions)	7
■ Inserting the Batteries in the Remote Control.....	8
■ Connecting the Aerial (or Cable Television Network).....	8
■ Switching Your Television On and Off.....	9
■ Placing Your Television in Standby mode	9
■ Plug & Play Feature.....	10
■ Choosing Your Language.....	11
◆ SETTING UP THE CHANNELS	
■ Storing the Channels Automatically.....	12
■ Selecting a Channel Numbered Ten or Over	12
■ Storing the Channels Manually.....	13
■ Skipping Unwanted Channels	14
■ Fine tuning Channel Reception	15
■ Sorting the Stored Channels	16
◆ USING THE TELEVISION	
■ Changing the Picture Standard	17
■ Selecting the Picture Format	17
■ Adjusting the Picture Settings	18
■ Changing the Sound Standard	19
■ Adjusting the Sound Settings	20
■ Adjusting the Volume.....	20
■ Extra Sound Settings (Auto Volume/Melody/Pseudo Stereo/Turbo Sound)	21
■ Selecting the Sound Mode	22
■ Switching the Sound Off Temporarily	22
■ Setting the Sleep Timer	23
■ Setting and Displaying the Current Time.....	23
■ Switching the Television On and Off Automatically	24
■ Activating the Child Lock	25
■ Extra Function Settings (Blue Screen/Low Noise AMP).....	26
◆ USING THE TELETEXT FUNCTION (depending on the model)	
■ Teletext Decoder	27
■ Displaying Teletext Information	27
■ Selecting a Specific Teletext Page.....	28
■ Using FLOF to Select a Teletext Page.....	28
■ Storing Teletext Pages	29
◆ INFORMATION ON CONNECTIONS AND RECOMMENDATIONS FOR USE	
■ Viewing Picture From External Sources	29
■ Connecting to the Audio/Video Input/Outputs	30
■ Automatic Degaussing to Remove Color Patches.....	31
■ Troubleshooting: Before Contacting Service Personnel.....	31

Symbols



Front Panel Controls (depending on the model)

ENG

➤ Buttons and markings are subject to change.

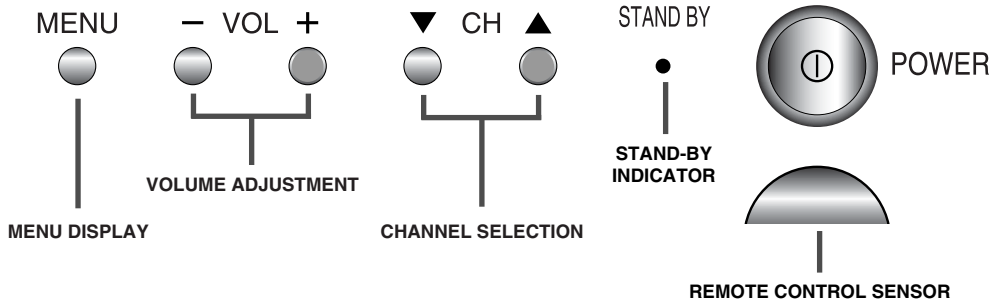
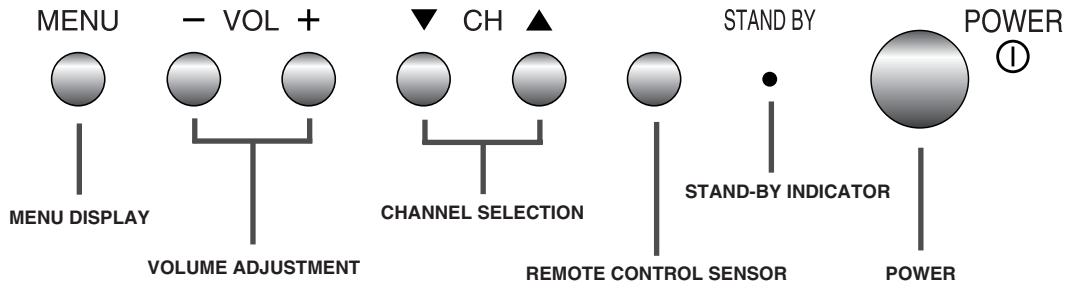

Using the Buttons on the Front Panel

If your remote control no longer works or you have lost it, you can use the controls on the front panel of the television to:

- ◆ *Switch on the television when it is in Standby mode and select channels (▼ CH ▲)*
- ◆ *Access the main menu (MENU)*
- ◆ *Adjust the volume (- VOL +)*

Buttons on the front panel have the same function as corresponding buttons on the remote control.

Connection Panels

- The actual configuration on your TV may be different, depending on your model.

ENG

Front (or Side) of TV



➤ Connecting earphones (🎧) /headphones (🎧)

- ◆ You can connect a set of earphones/headphones to your television if you wish to watch a television programme without disturbing the other people in the room.
- ◆ Prolonged use of earphones/headphones at a high volume may damage your hearing.

Rear of TV

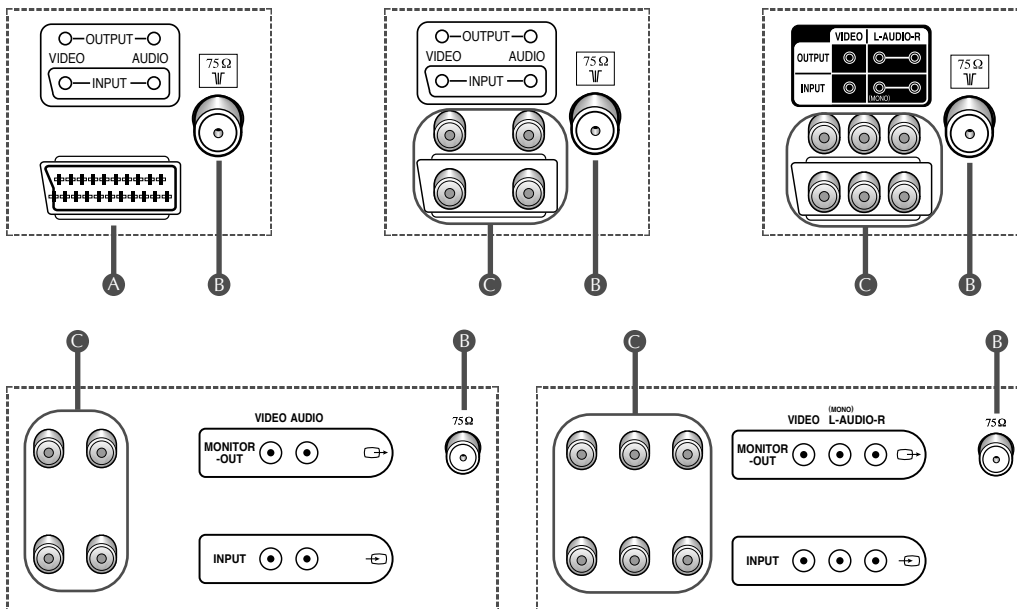

- A) SCART AUDIO/VIDEO INPUT/OUTPUT CONNECTOR
- B) 75Ω COAXIAL CONNECTOR FOR AERIAL/CABLE NETWORK
- C) RCA AUDIO/VIDEO INPUT/OUTPUT CONNECTORS

Infrared Remote Control (All Functions Except Teletext)

➤ Buttons and markings are subject to change.

ENG

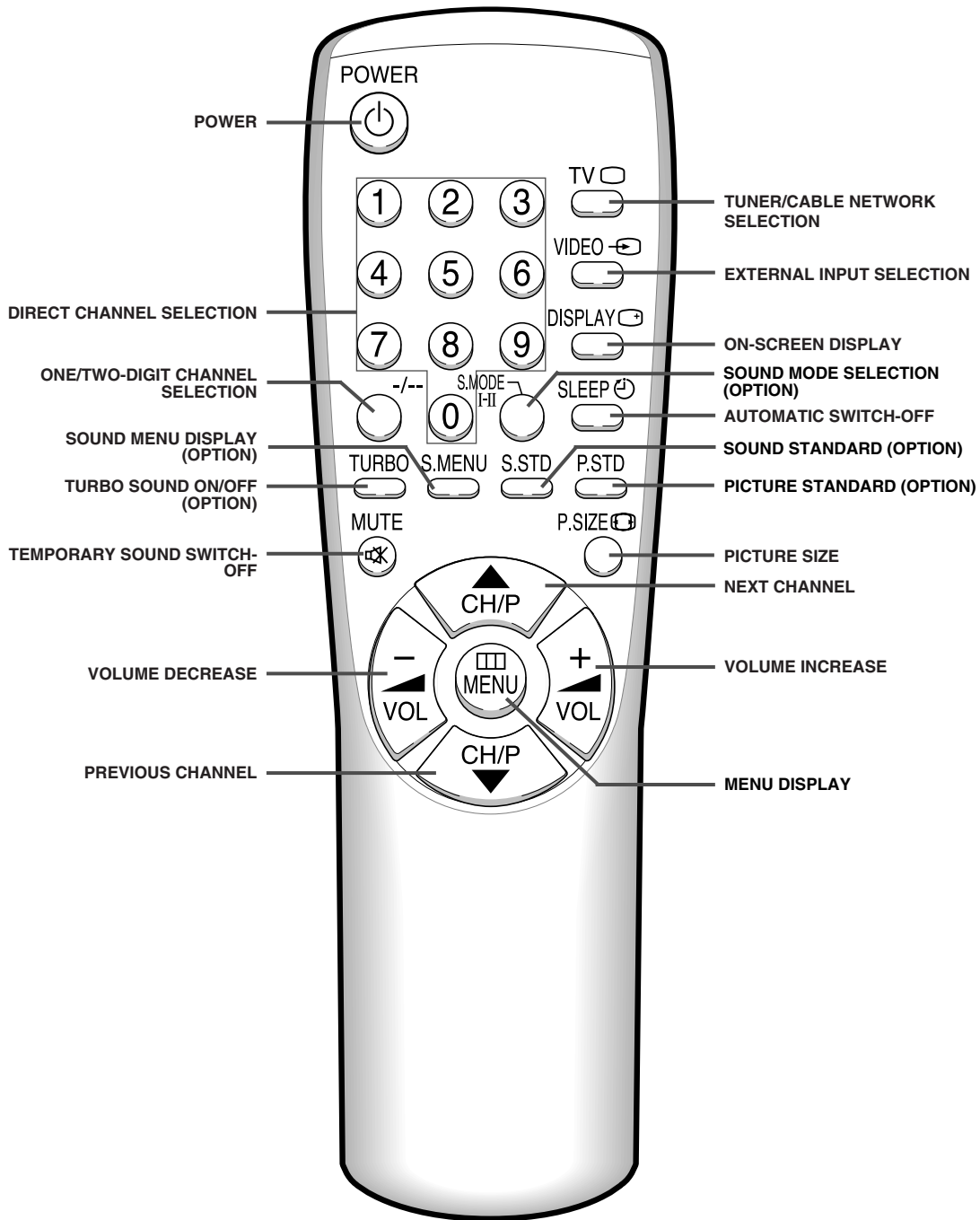

➤ Operation of remote control may be affected by bright artificial light near to the TV set.

Infrared Remote Control (Teletext Functions)

➤ Buttons and markings are subject to change.

ENG

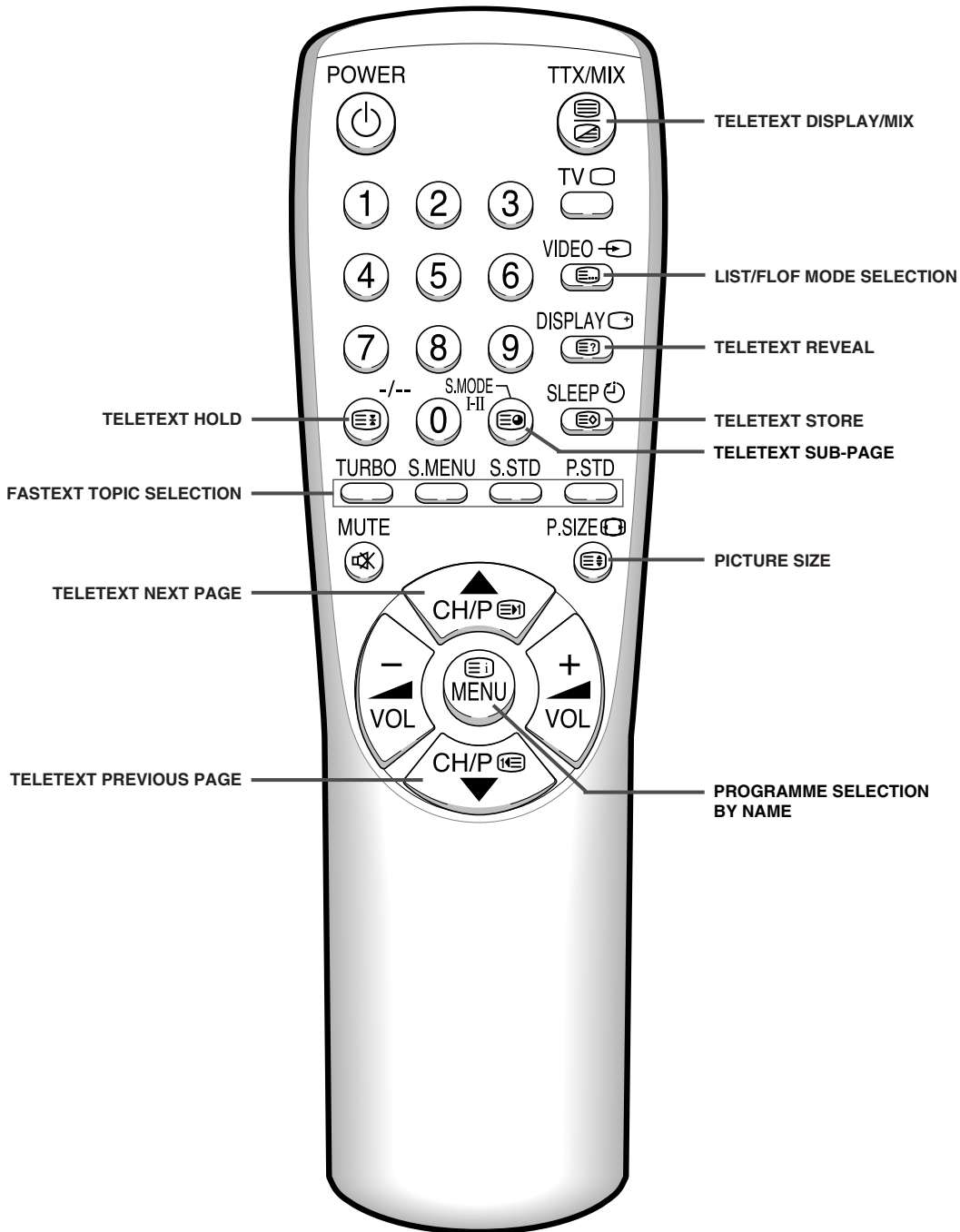

ENG

Inserting the Batteries in the Remote Control

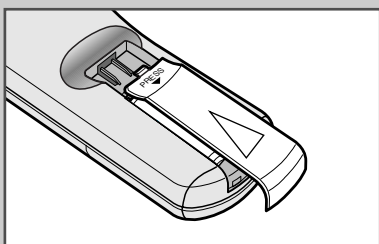
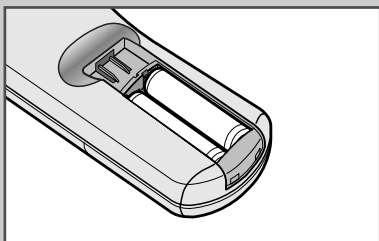
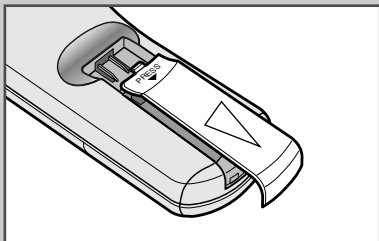

You must insert or replace the batteries in the remote control when you :

- ◆ *Purchase the television.*
- ◆ *Find that the remote control is no longer operating correctly.*

- 1 Remove the cover of the remote control by pressing the symbol (PRESS) and pulling the cover in the direction of the arrow.
- 2 Insert batteries, taking care to respect the polarities:
 - ◆ + on the battery with + on the remote control
 - ◆ - on the battery with - on the remote control
- 3 Replace the cover by pushing it in the direction of the arrow.

Connecting the Aerial (or Cable Television Network)

To view television channels correctly, a signal must be received by the set from one of the following sources:

- ◆ *An outdoor aerial*
- ◆ *A cable television network*

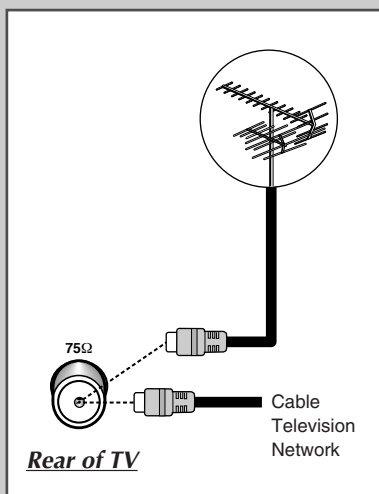

Plug the aerial or cable network input cable to the 75Ω coaxial socket on the rear of the television.

Switching Your Television On and Off

The mains lead is attached to the rear of the television.

- 1 Plug the mains lead into an appropriate socket.
➤ The main voltage is indicated on the rear of the TV set and the frequency is 50 or 60Hz.
- 2 Press the "⏻" (ON/OFF) button on the front of the television.
Result: The Standby indicator lights up on the front panel.
- 3 Press the **POWER** ⏻ button on the remote control to switch the television on.
Result: The programme that you were watching last is re-selected automatically.
- 4 To switch your television off, press the "⏻" (ON/OFF) button again on the front of the television.

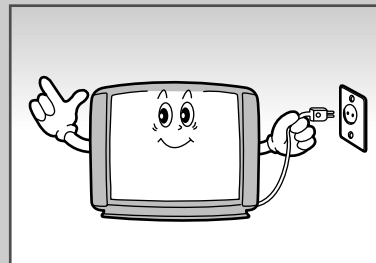

ENG

Placing Your Television in Standby mode

Your television can be placed in Standby mode, in order to reduce:

- ◆ *Power consumption*
- ◆ *Wear of the cathode ray tube*

The Standby mode can be useful when you wish to interrupt viewing temporarily (during a meal, for example).

The television is placed automatically in Standby mode when you turn it on.

- 1 Press the **POWER** ⏻ button on the remote control.
Result: The screen is turned off and the Standby indicator on the front of the television lights up.
- 2 To switch the screen back on, simply press the **POWER** ⏻ button again on the remote control.

- Do not leave your television in standby mode for long periods of time (when you are away on holiday, for example). In this case, you should switch it off completely.

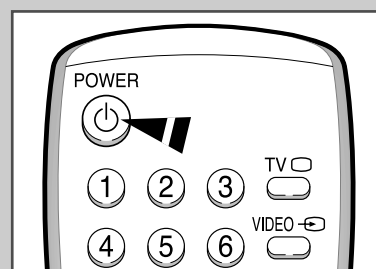

Plug & Play Feature

ENG

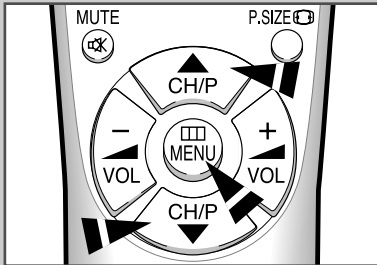

Plug & Play

Ant. Input Check

Auto Store Exit

P 1
471 MHz 48 %
Exit

Time
Clock -- : -- AM
Move Exit

ENJOY YOUR WATCHING

Function
Language : English
Time
Plug & Play
Blue Screen : Off
Child Lock : Off
Low Noise AMP : Off
Select Enter Exit

When the television is initially powered ON, three basic customer settings proceed automatically and subsequently: setting the language, channel and clock.

- 1 If the television is in Standby mode, press the **POWER** button on the remote control.

Result: The message "Plug & Play" is displayed. It flickers for a little while and then the "Language" menu is automatically displayed.

- 2 Press the **▲** or **▼** button to select required language. Press the **MENU** button to enter the language, and then the message "Ant. Input Check" is displayed.

➤ If any language is not selected on the "Language" menu, the "Language" menu will be displayed about 30 seconds later.

- 3 Make sure that the antenna is connected to the TV. And then press the **+** or **-** button to store the channels (refer to "Storing the Channels Automatically" on page 12).

Result: The horizontal bar is displayed, and then channels are stored in an order which reflects their positions in the frequency range.

- 4 When searching and storing is complete, the "Time" menu is displayed.

- 5 Press the **+** or **-** button to move to the hour or minute. Set the hour or minute by pressing the **▲** or **▼** button (refer to "Setting and Displaying the Current Time" on page 23).

- 6 When you have finished, press the **MENU** button.

Result: The message "ENJOY YOUR WATCHING" is displayed, and then the channel which has been stored will be activated.

- 7 **If you want to reset this feature...**

- 1 Press the **MENU** button.

- 2 Press the **▲** or **▼** button to select the "Function", and then press the **+** or **-** button.

- 3 Select the "Plug & Play" by pressing the **▲** or **▼** button, and then press the **+** or **-** button.

Result: The message "Plug & Play" is displayed.

Choosing Your Language

When you start using your television for the first time, you must select the language which will be used for displaying menus and indications.

- 1 Press the **MENU** button.
- 2 Press the **▲** or **▼** button to select the "Function".
- 3 Press the **+** or **-** button to select the "Language".
- 4 Select a particular language by pressing the **▲** or **▼** button repeatedly.
- 5 When you have finished, press the **TV** button or, press the **MENU** button repeatedly to return to normal viewing.

ENG

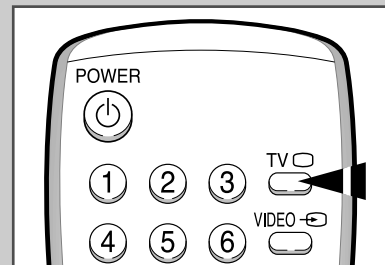
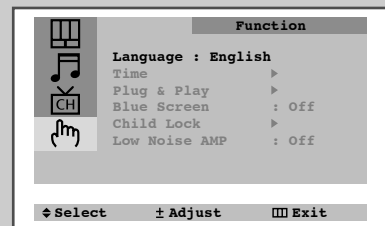
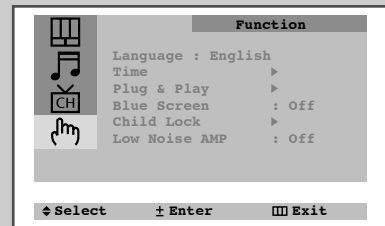
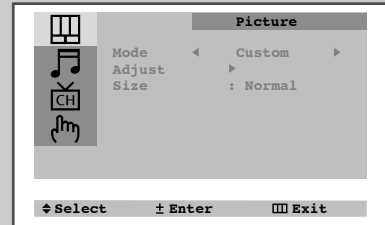

ENG

Storing the Channels Automatically

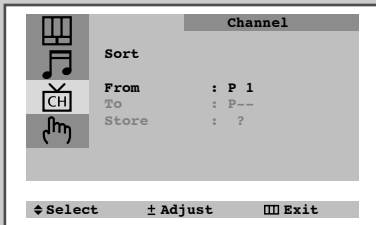
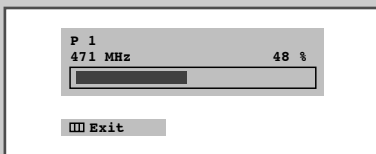
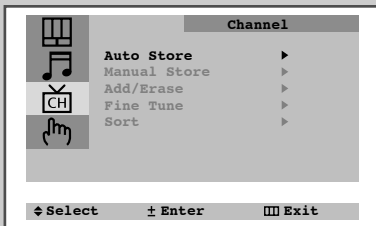
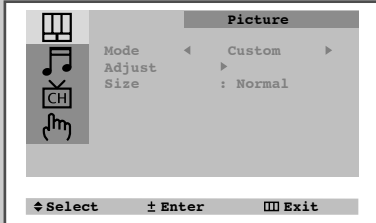

You can scan the frequency ranges available on your television and in your country and store all the channels found automatically.

The channels are stored in the order in which they appear in the frequency bands. It is possible that the automatically allocated numbers may not correspond to those by which you wish to identify the channels. If this is the case, refer to "Sorting the Stored Channels" on page 16.

- 1 Press the **MENU** button.
- 2 Press the **▲** or **▼** button to select the "Channel".
- 3 Press the **+** or **-** button to select the "Auto Store".
- 4 Press the **+** or **-** button again.
Result: The horizontal bar is displayed, and then channels are stored in an order which reflects their positions in the frequency range. Finally, the search will end automatically.
- 5 When searching and storing is complete, the "Sort" menu is displayed.

To...	Then...
Sort the stored channels into the desired numerical order	Go to Step 4 of the "Sorting the Stored Channels" procedure on page 16.
Exit the channel store function without sorting the channels	Press the MENU button repeatedly until the menus disappear.

➤ If sound does not work regularly after storing channels, select the sound system which best corresponds in "Manual Store" menu (refer to the opposite page).

Selecting a Channel Numbered Ten or Over



When using the numeric buttons to select a channel stored at programme position ten or higher, follow the instructions below.

- 1 Press the **-/--** button.
Result: The "--" symbol is displayed.
- 2 Enter the two-digit channel number.
Example: To select channel 42, press 4, followed by 2.

Storing the Channels Manually

When storing channels manually, you can choose:

- ◆ Whether or not to store each of the channels found.
- ◆ The number by which you wish to identify each stored channel.

- 1 Press the **MENU** button.
- 2 Press the **▲** or **▼** button to select the "Channel" and press the **+** or **-** button.
- 3 Press the **▲** or **▼** button to select the "Manual Store" and press the **+** or **-** button.
Result: The "Manual Store" menu is displayed with the "Color System" selected.
- 4 Press the **+** or **-** button repeatedly until the color is of the best quality.

Result: The "Color System" is changed (depending on the model).

AUTO ↔ PAL ↔ SECAM ↔ NTSC4.43 ↔ NTSC3.58



- NTSC4.43 is a "trick" playback mode used by special VCR's to play PAL-recorded videos in NTSC mode.

- 5 Press the **▲** or **▼** button to select the "Sound System" and press the **+** or **-** button repeatedly until the sound is of the best quality.

Result: The "Sound System" is changed (depending on the model).

B/G ↔ D/K ↔ I ↔ M



- If sound does not work regularly after storing channels, select the sound system which best corresponds.

- 6 To start the search, select the "Search" and then press the **+** or **-** button.

Result: The tuner scans the frequency range until the first channel or the channel that you selected is received on your screen.

- 7 To assign a programme number to the channel, select the "Prog.No.". Press the **+** or **-** button until you find the correct number.

- 8 To store the channel and associated programme number, select the "Store" and press the **+** or **-** button.

Result: "OK" is displayed.

- 9 Repeat Steps **6** to **8** for each channel to be stored.

- 10 When you have finished manual storage, press the **TV** button or, press the **MENU** button repeatedly to return to normal viewing

ENG

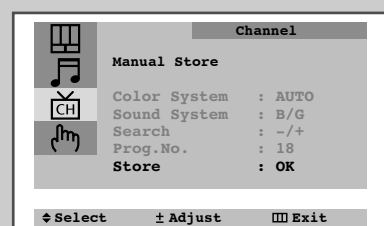
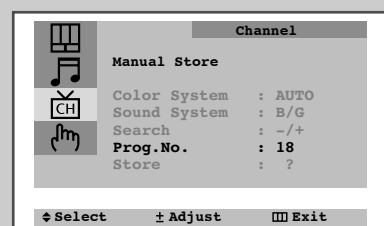
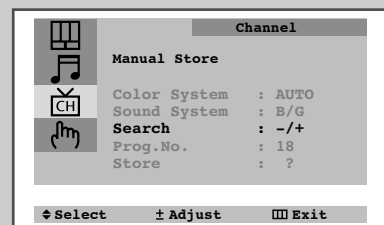
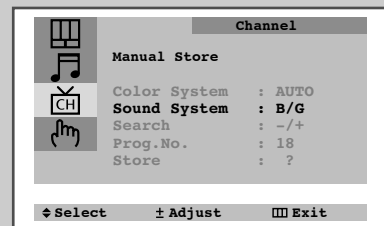
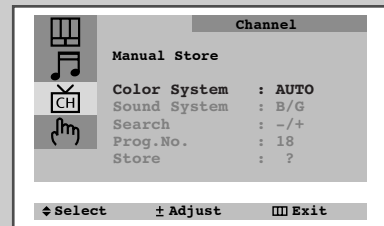
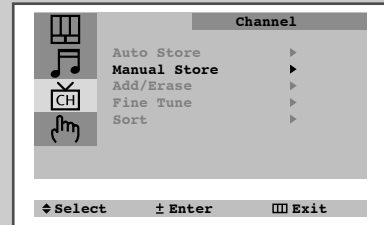

Skipping Unwanted Channels

ENG

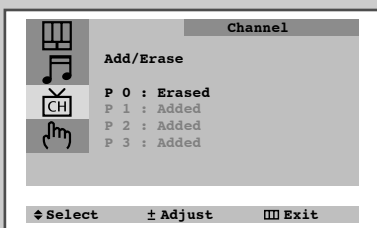
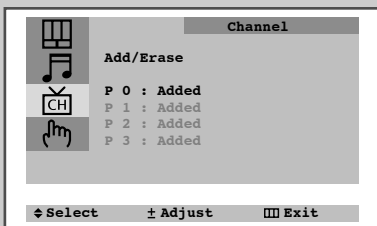
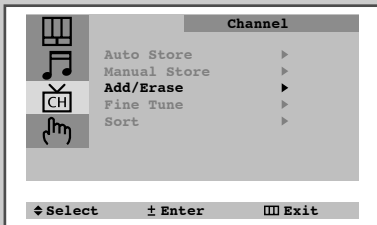

You can exclude the channels of your choice from the channel scan operation. When you scan through the stored channels, those you have chosen to skip are not displayed.

All channels that you do not specifically choose to skip are displayed during scanning.

- 1 Press the **MENU** button.
- 2 Press the **▲** or **▼** button to select the “Channel” and press the **+** or **-** button.
- 3 Press the **▲** or **▼** button to select the “Add/Erase” and press the **+** or **-** button.
Result: The “Add/Erase” menu is displayed.
- 4 Press the **▲** or **▼** button to select the required channel.
- 5 To add or erase the desired channel by pressing the **+** or **-** button.
- 6 When you have finished adding and erasing channels, press the **TV** button or, press the **MENU** button repeatedly to return to normal viewing

Fine tuning Channel Reception

If the reception is clear, you do not have to fine-tune the channel, as this is done automatically during the search and store operation. If however the signal is weak or distorted, you may have to fine-tune the channel manually.

- 1 Press the **MENU** button.
- 2 Press the **▲** or **▼** button to select the "Channel" and press the **+** or **-** button.
- 3 Press the **▲** or **▼** button to select the "Fine Tune" and press the **+** or **-** button.

Result: The "Fine Tune" menu is displayed with the "Tune" selected.

- | 4 To... | Press the... |
|---|---|
| obtain a sharp and clear picture and good sound quality | <ul style="list-style-type: none"> ◆ + or - button. Result: The horizontal bar's cursor moves to the left or right. |
| memorise adjusted picture or sound | <ul style="list-style-type: none"> ◆ ▲ or ▼ button to select the "Store". ◆ + or - button. Result: "OK" is displayed. |
| erase adjusted picture or sound | <ul style="list-style-type: none"> ◆ ▲ or ▼ button to select the "Erase". ◆ + or - button. Result: "OK" is displayed. |
- 5 When you have finished, press the **TV** button or, press the **MENU** button repeatedly to return to normal viewing.

ENG

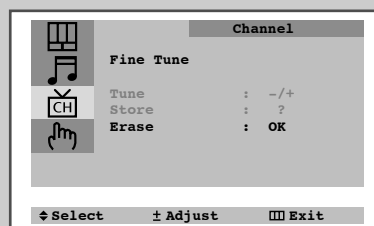
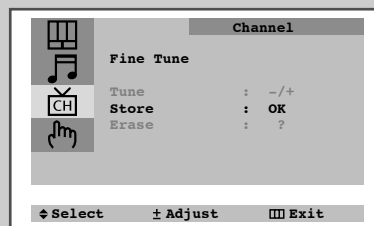
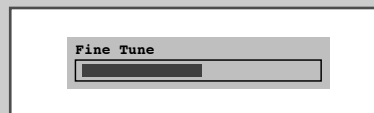
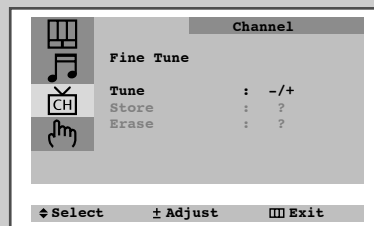
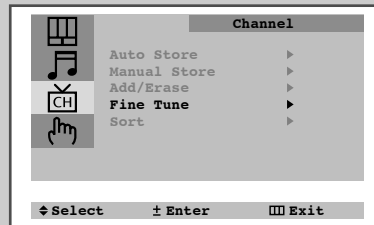

Changing the Picture Standard

You can select the type of picture which best corresponds to your viewing requirements. The following picture effects are available in the order given:

- ◆ Custom, Standard, Sports, Natural, Mild.

- 1 Press the **MENU** button.
Result: The "Picture" menu is displayed.
- 2 Press the **+** or **-** button.
Result: The "Mode" menu is selected.
- 3 Select to satisfy your preference by pressing the **+** or **-** button.
- 4 When you have been finished, press the **TV** button or, press the **MENU** button repeatedly to return to normal viewing.

➤ You can select the required picture effect by simply pressing the "P.STD" (Picture standard) button on the remote control.

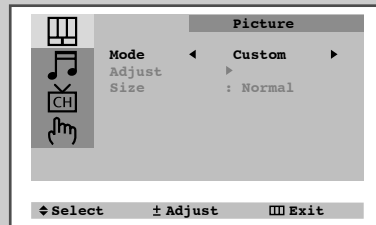

Selecting the Picture Format (depending on the model)

You can select the picture format which best corresponds to your viewing requirements. The following picture formats are available in the order given:

- ◆ Normal
- ◆ Zoom
- ◆ 16:9 (option)

- 1 Press the **MENU** button.
Result: The "Picture" menu is displayed.
- 2 Press the **+** or **-** button.
- 3 Press the **▲** or **▼** button to select the "Size".
- 4 Select to satisfy your preference by pressing the **+** or **-** button.
- 5 When you have been finished, press the **TV** button or, press the **MENU** button repeatedly to return to normal viewing.

➤ You can select the required picture format by simply pressing the "P.SIZE" (Picture size) button on the remote control.

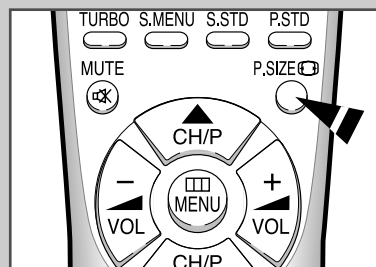
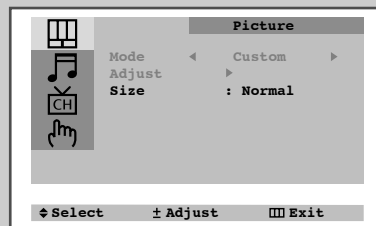

Adjusting the Picture Settings

ENG

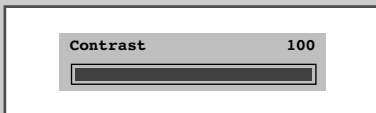
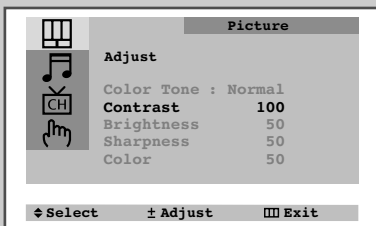
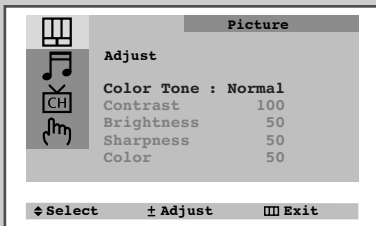
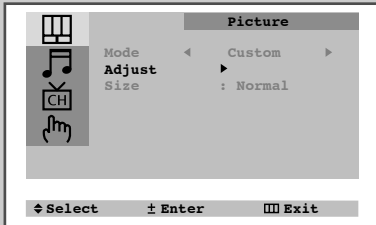

Your television has several settings which allow you to control picture quality:

◆ Color Tone, Contrast, Brightness, Sharpness, Color, Tint (NTSC only)

- 1 Press the **MENU** button.
Result: The "Picture" menu is displayed.

- 2 Press the **+** or **-** button.

- 3 Press the **▲** or **▼** button to select the "Adjust", and then press the **+** or **-** button.
Result: When select the "Mode" to "Custom", the "Adjust" menu is displayed.

4 To adjust the...	Press the...
◆ Color Tone	◆ + or - button. <u>Result:</u> You select the required option (Normal, Warm1, Warm2, Cool1, Cool2).
◆ Contrast	◆ + or - button.
◆ Brightness	<u>Result:</u> The horizontal bar is displayed.
◆ Sharpness	
◆ Color	
◆ Tint (NTSC only)	

- 5 When you are satisfied with the settings, press the **TV** button or, press the **MENU** button repeatedly to return to normal viewing.

- The television has an "automatic degaussing" system that is activated if magnetic interference is present. To degauss the television screen, switch power off by pressing the "Ⓜ" (ON/OFF) button on the front panel (refer to "Automatic Degaussing to Remove Color Patches" on page 31).
- If you make any changes to the "Adjust" settings, the picture standard is automatically switched to "Custom".

Changing the Sound Standard (depending on the model)

You can select the type of special sound effect to be used when watching a given broadcast. The following sound effects are available in the order given:

- ◆ Custom, Standard, Music, Movie, Speech.

- 1 Press the **MENU** button.

- 2 Press the ▲ or ▼ button to select the “Sound” and press the + or – button.
 Result: The “Mode” menu is selected.

- 3 Select to satisfy your preference by pressing the + or – button.

- 4 When you have been finished, press the **TV** button or, press the **MENU** button repeatedly to return to normal viewing.

➤ You can select the required sound effect by simply pressing the “S.STD” (Sound standard) button on the remote control.

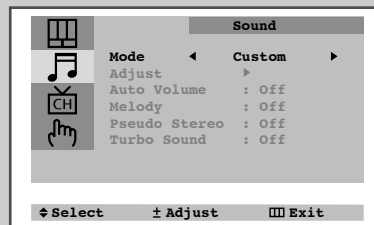

ENG

Adjusting the Sound Settings (depending on the model)

ENG

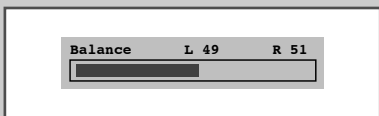
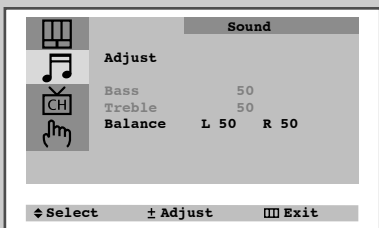
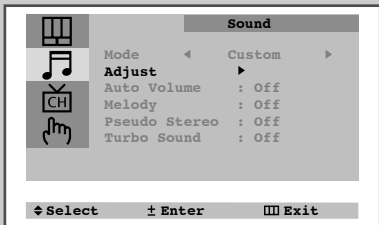

Adjusting the Volume

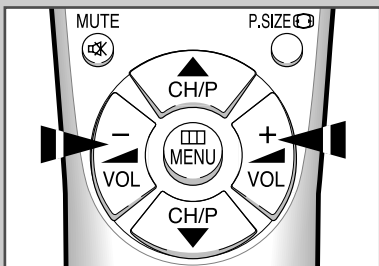

The sound settings can be adjusted to suit your personal preferences.

- 1 Press the **MENU** button.
- 2 Press the **▲** or **▼** button to select the “Sound” and press the **+** or **-** button.
- 3 Press the **▲** or **▼** button to select the “Adjust” and press the **+** or **-** button.
Result: When select the “Mode” to “Custom”, the “Adjust” menu is displayed.
- 4 Select the required option by pressing the **▲** or **▼** button and adjust to satisfy your preference by pressing the **+** or **-** button.
- 5 Press the **+** or **-** button.
Result: The horizontal bar is displayed.
- 6 When you are satisfied with the settings, press the **TV** button or, press the **MENU** button repeatedly to return to normal viewing.

➤ You can display the sound adjust menu directly by pressing the “S.MENU” (Sound menu) button on the remote control.

You can adjust the volume by pressing the **+** or **-** button on the remote control.

- ◆ Press the **+** button to increase the volume (cursor moves to the right)
 - ◆ Press the **-** button to decrease the volume (cursor moves to the left)
- The volume setting is retained:
- ◆ When you switch the television to standby mode
 - ◆ When you switch the television off using the “**Ⓞ**” (ON/OFF) button on the front panel
 - ◆ If there is a power failure.

Extra Sound Settings (depending on the model)

The following sound settings can be adjusted to suit your personal preferences.

◆ Auto Volume

Each broadcasting station has its own signal conditions, and so it is not easy for you to adjust the volume every time the channel is changed. "Auto Volume" lets you automatically adjust the volume of the desired channel by lowering the sound output when the modulation signal is high or by raising the sound output when the modulation signal is low.

◆ Melody

You can hear clear melody sound when the TV is powered ON or OFF.

◆ Pseudo Stereo

"Pseudo Stereo" converts a monaural sound signal into two identical left and right channels. Once the "Pseudo Stereo" is set to "On" or "Off", the setting applies to the sound effects such as Standard, Music, Movie and Speech.

◆ Turbo Sound

You can enjoy more magnificent and dynamic sound when watching music, movie or other channel. "Turbo Sound" suitably emphasizes both higher and lower bands of sound (and includes other effects).

- 1 Press the **MENU** button.
- 2 Press the **▲** or **▼** button to select the "Sound" and press the **+** or **-** button.
- 3

To...	Press the...
Change an option	▲ or ▼ button.
Select the required option (On/Off)	+ or - button.
- 4 When you are satisfied with the settings, press the **TV** button or, press the **MENU** button repeatedly to return to normal viewing.

➤ You can select the turbo sound by simply pressing the "TURBO" button on the remote control.

ENG

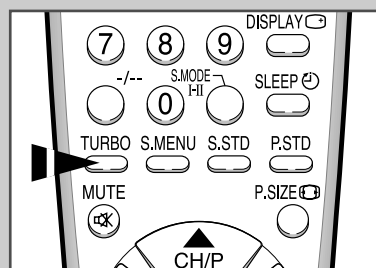
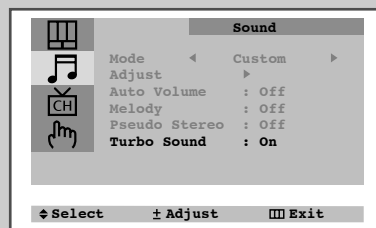
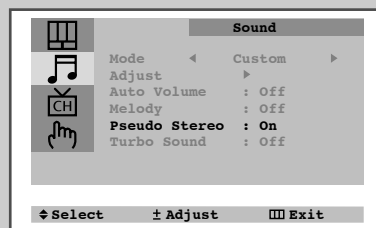
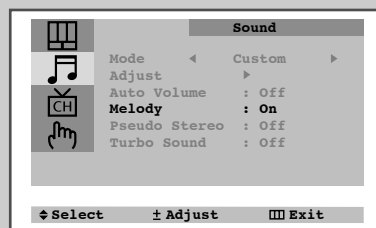
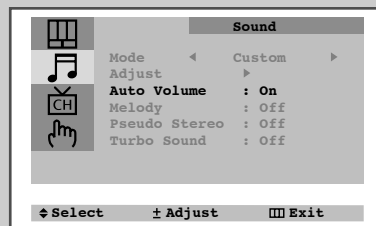
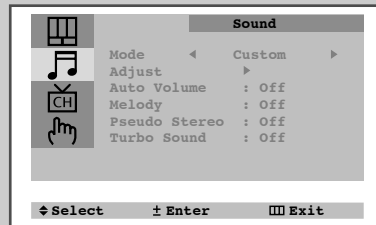

Selecting the Sound Mode (depending on the model)

ENG

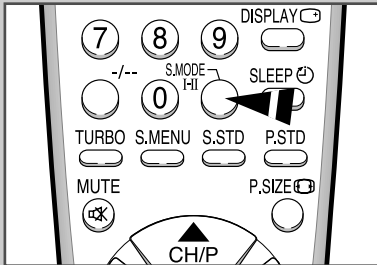

The "S.MODE I-II" button displays/controls the processing and output of the audio signal. When power is switched ON, the mode is automatically preset to either "Dual-I" or "STEREO", depending on the current transmission.

	Type of broadcast	On-screen indication
NICAM Stereo	Regular broadcast (Standard audio)	MONO (Normal use)
	Regular + NICAM Mono	MONO ↔ MONO NICAM (Normal)
	NICAM Stereo	STEREO ↔ MONO NICAM (Normal)
	NICAM Dual-I/II	Dual-I → Dual-II → MONO NICAM NICAM (Normal) ↑ ↑
A2 Stereo	Regular broadcast (Standard audio)	MONO (Normal use)
	Bilingual or Dual-I/II	Dual-I ↔ Dual-II
	Stereo	STEREO ↔ MONO (Forced Mono)

- ◆ If the receiving conditions deteriorate, listening will be easier if the mode is set to the "MONO" position using the **S.MODE I-II** button.
- ◆ If the stereo signal is weak (or if intermittent Stereo-Mono) and automatic switching occurs, then switch to the "MONO" mode.
- ◆ When receiving mono sound in the AV mode, connect to the "L" input jack on the panels. If the mono sound comes out only from the left speaker, then press the **S.MODE I-II** button.

Switching the Sound Off Temporarily

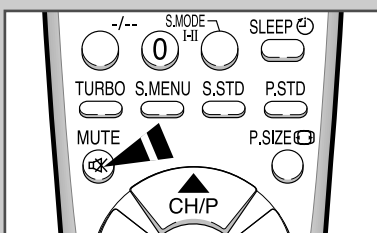

You can switch the sound off temporarily, for example you may wish to answer the telephone.

- 1 Press the **MUTE** button.
Result: The sound is switched off and "M" is displayed.
- 2 When you wish to turn the sound back on at the same volume as before, press the **MUTE** button again (or either of the volume buttons).

Setting the Sleep Timer

You can select a time period of between 30 and 180 minutes after which the television automatically switches to Standby mode by pressing the "SLEEP" button.

- Press the **SLEEP** button on the remote control.

Result:

If the sleep timer is...	The screen displays...
Already set	Time remaining before the television will be placed in standby mode.
Not yet set	Word "Off".
- Press the **SLEEP** button repeatedly and cycle through the preset time intervals (30, 60, 90, 120, 150, 180).

Result: The television automatically switches to standby mode when the timer reaches 0.
- To cancel the sleep timer function, press the **SLEEP** button repeatedly and select "Off".



Setting and Displaying the Current Time (depending on the model)

You can set the television's clock so that the current time is displayed when you press the "DISPLAY" button.

You must also set the time if you wish to use the automatic On/Off timers.

➤ The clock setting will be re-activated when pressing the "ON/OFF" button on the front panel.

- Press the **MENU** button.
- Press the **▲** or **▼** button to select the "Function" and press the **-** or **+** button.
- Press the **▲** or **▼** button to select the "Time", and press the **-** or **+** button.

Result: The "Time" menu is displayed with the "Clock" selected.
- | To... | Press the... |
|----------------------------|------------------------------|
| Move to the hour or minute | - or + button. |
| Set the hour or minute | ▲ or ▼ button. |
- When you have finished, press the **TV** button or, press the **MENU** button repeatedly to return to normal viewing.
- | To display the... | Press the DISPLAY button... |
|---------------------|-----------------------------|
| Channel information | Once. |
| Current time | Twice. |
- To remove the display, press the **DISPLAY** button again.

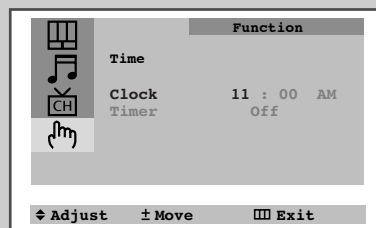
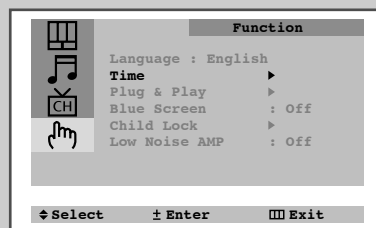

Switching the Television On and Off Automatically (depending on the model)

ENG

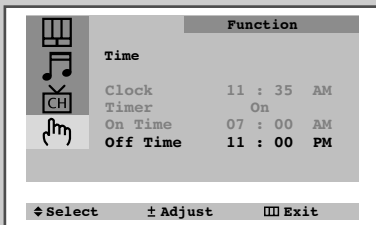
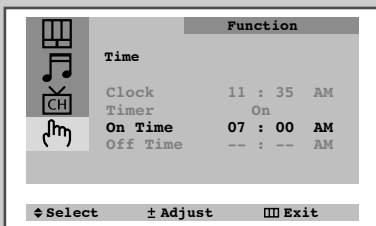
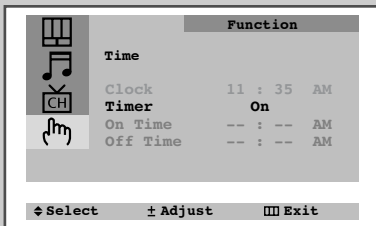
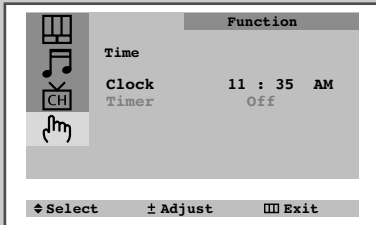

You can set the On/Off timers so that the television will:

- ◆ Switch on automatically and tune to the channel of your choice at the time you select
- ◆ Switch off automatically at the time you select

➤ The first step is to set the television's clock (refer to "Setting and Displaying the Current Time" on the previous page). If you have not yet set the clock, the message "Set the clock first" is displayed.

- 1 Press the **MENU** button.
- 2 Press the **▲** or **▼** button to select the "Function" and press the **-** or **+** button.
- 3 Press the **▲** or **▼** button to select the "Time", and press the **-** or **+** button.
Result: The "Time" menu is displayed.
- 4 Press the **▲** or **▼** button to select the "Timer".
- 5 Press the **-** or **+** button to set the mode to "On".
Result: The "On Time" and "Off Time" options are displayed.
- 6 Press the **▲** or **▼** button to select the "On Time".
- 7 Set the time at which you wish the television to be switched On.

To...	Press the...
Move to the hour or minute	- or + button.
Adjust the hour or minute	▲ or ▼ button.
- 8 In the same way, set the time at which you wish the television to be switched Off.
- 9 When you have finished setting the On/Off time, press the **TV** button or, press the **MENU** button repeatedly to return to normal viewing.

➤ Fuzzy Power Off

If no function buttons (including remote control buttons or front panel buttons) are operated for three hours after the TV is turned on by "On time", the TV will be automatically turned off.

Activating the Child Lock (depending on the model)

You can restrict viewing by locking the channels of your choice.

Example: You can prevent your children from watching unsuitable programmes.

- 1 Press the **MENU** button.
- 2 Press the **▲** or **▼** button to select the "Function" and press the **-** or **+** button.
- 3 Press the **▲** or **▼** button to select the "Child Lock" and press the **-** or **+** button.
Result: The "Child Lock" menu is displayed.
- 4 Set to "On" by pressing the **-** or **+** button.
➤ If you want to unlock a channel, set to "Off".
- 5 Press the **▲** or **▼** button to select the "Prog.No.". Select the number of the channel to be locked by pressing the **-** or **+** button.
- 6 Press the **▲** or **▼** button to select the "Lock" and press the **-** or **+** button.
Result: "Locked" is displayed.
- 7 When you have finished, press the **TV** button or, press the **MENU** button repeatedly to return to normal viewing.

➤ If any channel is locked, you cannot enter the "Channel" menu (the message "Not available" is displayed).

ENG

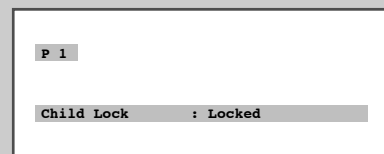
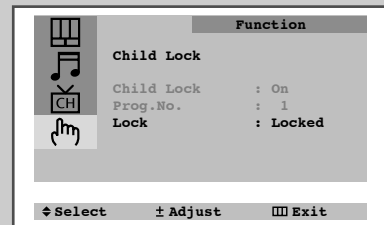
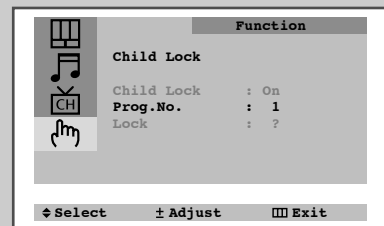
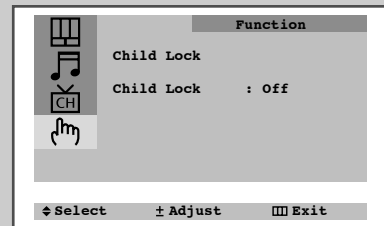
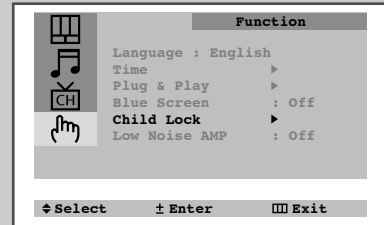

Extra Function Settings (depending on the model)

ENG

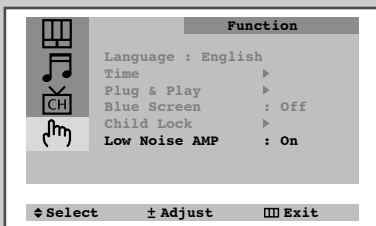
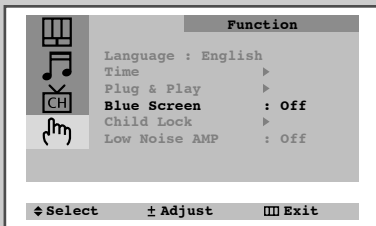
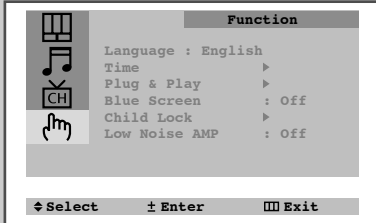

The following settings can be adjusted to suit your personal preferences.

◆ Blue Screen

If no signal is being received or the signal is very weak, a blue screen automatically replaces the noisy picture background. If you wish to continue viewing the poor picture, you must set the "Blue Screen" mode to "Off".

◆ Low Noise AMP

This function is very useful in the situation that the TV is used in weak signal. LNA amplifies the TV signal in the weak signal area, but not noise. This feature is working only weak signal condition, and that is memorized on current channel, additional.

- 1 Press the **MENU** button.
- 2 Press the **▲** or **▼** button to select the "Function" and press the **+** or **-** button.
- 3

To...	Press the...
Change an option	▲ or ▼ button.
Select the required option (On/Off)	+ or - button.
- 4 When you are satisfied with the settings, press the **TV** button or, press the **MENU** button repeatedly to return to normal viewing.

Teletext Decoder

Most television channels carry “teletext,” pages of written information that provide information such as:

- ◆ *Television programme times*
- ◆ *News bulletins*
- ◆ *Weather forecasts*
- ◆ *Sports results*
- ◆ *Subtitles for the hard of hearing*

The teletext pages are organized according to six categories:

Part	Contents
A	Selected page number.
B	Broadcasting station identity.
C	Current page number or search status
D	Date and time.
E	Text.
F	Status information.

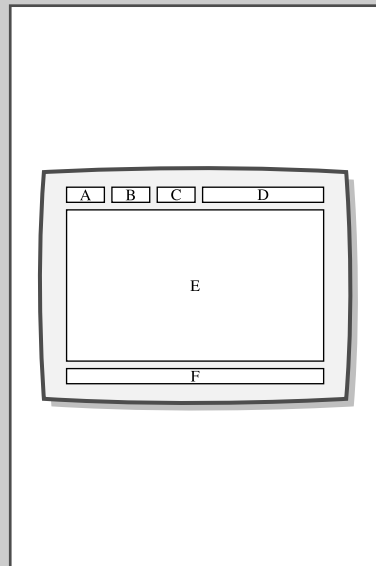

Displaying Teletext Information

You can display teletext information at any time, but signal reception must be good. Otherwise:

- ◆ *Information may be missing*
- ◆ *Some pages may not be displayed*

To activate the teletext mode and display the contents page:

- 1 Using the ▲ (INDEX) or ▼ (INDEX) button, select the channel providing the teletext service.
- 2 Press the **TTX/MIX** (TTX/MIX) button to activate the teletext mode.
Result: The contents page (page 100) is displayed. It can be redisplayed at any time by pressing the INDEX (INDEX) button.
- 3 To display the actual broadcast simultaneously with the teletext page, press the **TTX/MIX** (TTX/MIX) button.
- 4 To return to normal viewing press the **TV** (TV) button.

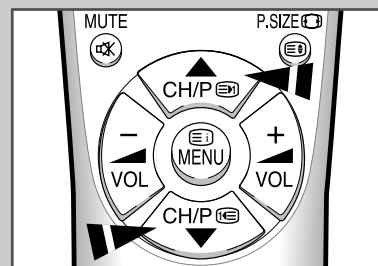

Selecting a Specific Teletext Page

ENG

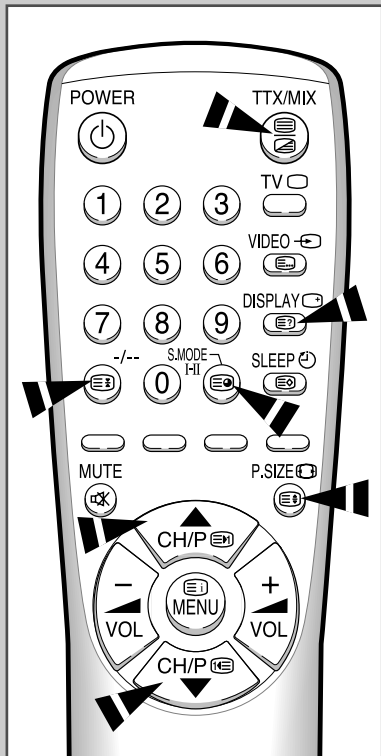

Press the number buttons on the remote control to enter the page number directly:

- 1 Enter the three-digit page number listed in the contents by pressing the corresponding numeric buttons.

Result: The current page counter is incremented and the page is then displayed.

- 2 If the selected page is linked with several secondary pages, the secondary pages are displayed in sequence. To freeze the display on a given page, press the HOLD (⏸). Press the HOLD again to resume.

- 3 Using the various display options:

To display...	Press the...
◆ Both teletext information and the normal broadcast	TTX/MIX (Ⓜ)
◆ Hidden text (answers to quiz games, for example)	REVEAL (Ⓜ)
◆ The normal screen	REVEAL (Ⓜ) again
◆ A secondary page, by entering its 4-digit number	SUB-PAGE (Ⓜ)
◆ The next page	PAGE UP (⏮)
◆ The previous page	PAGE DOWN (⏭)
◆ Double-size letters in the: <ul style="list-style-type: none"> • Upper half of the screen • Lower half of the screen 	SIZE (Ⓜ) <ul style="list-style-type: none"> ◆ Once ◆ Twice
◆ Normal screen	◆ Three times

Using FLOF to Select a Teletext Page

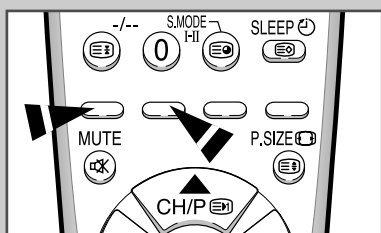
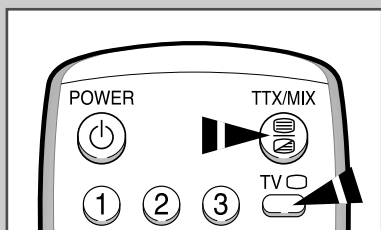

The various topics included in the teletext pages are color-coded, and can be selected by pressing the colored buttons on the remote control.

- 1 Display the teletext contents page by pressing the TTX/MIX (Ⓜ) button.

- 2 Press the colored button corresponding to the topic that you wish to select (The available topics are listed on the status information line).

Result: The page is displayed with additional color-coded information that can be selected in the same way.

To display the:	Press the:
Previous page	Red button.
Next page	Green button.

- 4 When you have finished, press the TV (Ⓜ) button to return to the normal broadcast.

Storing Teletext Pages

Up to four teletext pages can be stored.

- 1 Select the LIST mode.
Result: Four 3-digit numbers are displayed in different colors at the bottom of the screen.
- 2 Press the colored button corresponding to the page that will be replaced.
- 3 Enter the new page number using the numeric buttons.
- 4 Repeat steps 2 and 3 for each page to be stored, using a different colored button each time.
- 5 Press the STORE (📄) button until the corresponding blocks are displayed in white.

- The LIST (📄) button is used to switch between:
 - ◆ LIST mode
 - ◆ FLOF mode



Viewing Pictures From External Sources

Once you have connected up your various audio and video systems, you can view the different sources by selecting the appropriate input.

- 1 Check that all the necessary connections have been made.
- 2 Switch the television on and if necessary, press the VIDEO (📺) button one or more times until the required input is displayed.

- Depending on the source selected, the pictures may appear automatically.

- To watch television programmes again, press the TV (📺) button and select the number of the channel required.

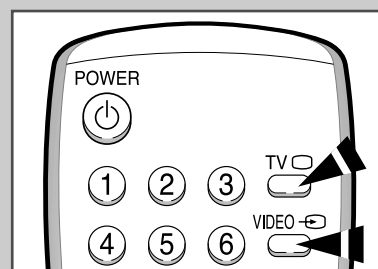

ENG

Connecting to the Audio/Video Input/Outputs

➤ The actual configuration on your TV may be different, depending on your model.

Rear of TV
(depending on the model)

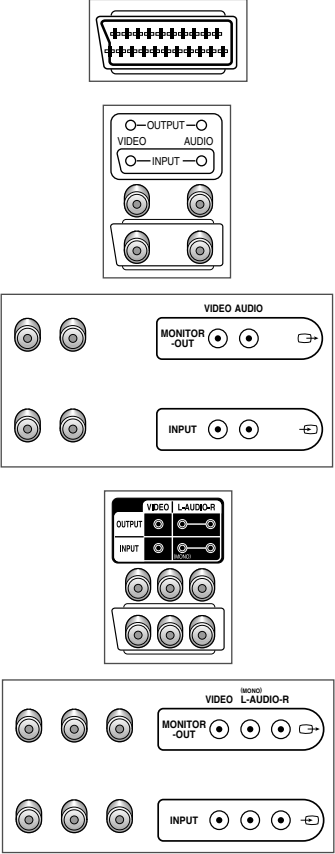

AV cable
(depending on the model)

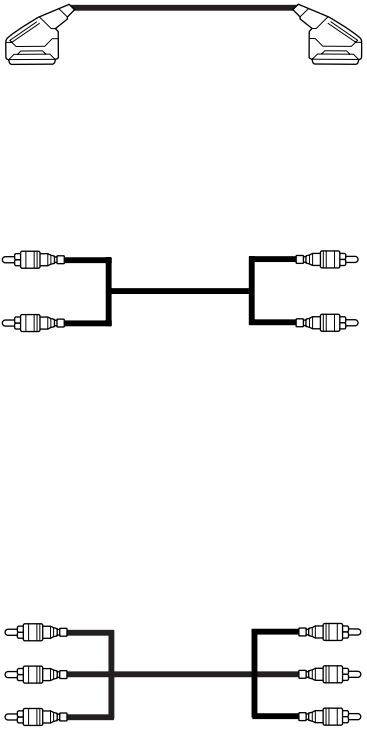

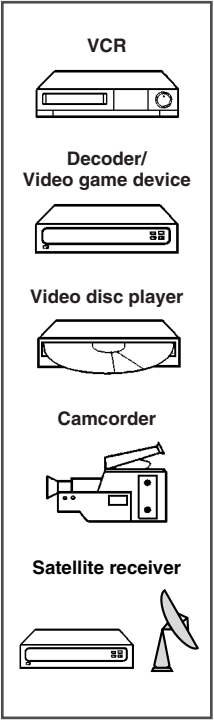

Front (or Side) of TV
(depending on the model)

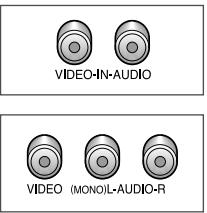

AV cable
(depending on the model)

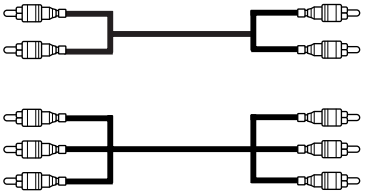

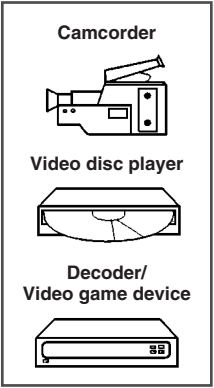

➤ ◆ The Audio/Video connector on the front (or side) of the television is used for equipment, such as camcorders, video disc players and certain video games.

◆ When both the front (or side) and rear connectors are connected to external equipment, the front (or side) AV has the priority.

Automatic Degaussing to Remove Color Patches

ENG

A degaussing coil is mounted around the picture tube, so you do not normally need to degauss the television manually.

If you move the television to a different position and color patches appear on the screen, you must:

- ◆ *Switch the television off by pressing the “⓪” (ON/OFF) button on the front panel*
- ◆ *Unplug the television from the wall socket*
- ◆ *Leave the television power-off (stand-by) for about 30 minutes so that the automatic degauss function can be activated, and then press the POWER ⏻ button on the remote control.*

 *If your television will be left unattended, press the “⓪” (ON/OFF) button to turn your television off.*

Troubleshooting: Before Contacting Service Personnel

Before contacting Samsung after-sales service, perform the following simple checks.

If you cannot solve the problem using the instructions below, note the model and serial number of the television and contact your local dealer.

No sound or picture	<ul style="list-style-type: none"> ◆ Check that the mains lead has been connected to a wall socket. ◆ Check that you have pressed the “⓪” (ON/OFF) button. ◆ Check the picture contrast and brightness settings. ◆ Check the volume.
Normal picture but no sound	<ul style="list-style-type: none"> ◆ Check the volume. ◆ Check whether the MUTE  button has been pressed on the remote control.
No picture or black and white picture	<ul style="list-style-type: none"> ◆ Adjust the colour settings. ◆ Check that the broadcast system selected is correct.
Sound and picture interference	<ul style="list-style-type: none"> ◆ Try to identify the electrical appliance that is affecting the television and move it further away. ◆ Plug your television into a different mains socket.
Blurred or snowy picture, distorted sound	<ul style="list-style-type: none"> ◆ Check the direction, location and connections of your aerial. This interference is often due to the use of an indoor aerial.
Remote control malfunctions	<ul style="list-style-type: none"> ◆ Replace the remote control batteries. ◆ Clean the upper edge of the remote control (transmission window). ◆ Check the battery terminals.

- AFTER SALES SERVICE

- Do not hesitate to contact your retailer or service agent if a change in the performance of your product indicates that a faulty condition may be present.

