

SONY[®]

4-075-501-21



FD Trinitron
WEGA

Trinitron[®] ***Color TV***

Operating Instructions

KV-20FV12
KV-24FV12

WARNING

To reduce the risk of fire or electric shock, do not expose the TV to rain or moisture.

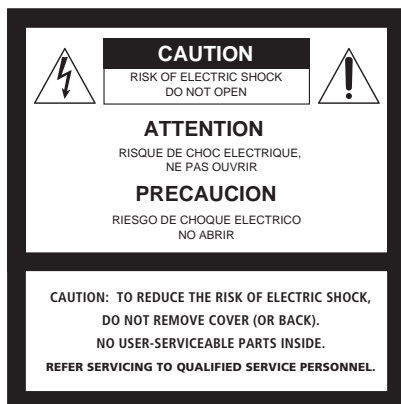

This symbol is intended to alert the user to the presence of uninsulated “dangerous voltage” within the product’s enclosure that may be of sufficient magnitude to constitute a risk of electric shock to persons.



This symbol is intended to alert the user to the presence of important operating and maintenance (servicing) instructions in the literature accompanying the appliance.

Note to the CATV Installer

This reminder is provided to call the CATV system installer’s attention to Article 820-40 of the NEC that provides guidelines for proper grounding and, in particular, specifies that the cable ground shall be connected to the grounding system of the building as close to the point of cable entry as practical.

SAFETY PRECAUTIONS

- Operate the TV only on 120 V AC.
- One blade of the power plug is wider than the other for safety purposes and will fit into the power outlet only one way. If you are unable to insert the plug fully into the outlet, contact your dealer.
- If any liquid or solid object falls into the TV, unplug it and have it checked by qualified personnel before operating it further.

CAUTION

When using TV games, computers, and similar products with your TV, keep the brightness and contrast functions at low settings. If a fixed (non-moving) pattern is left on the screen for long periods of time at a high brightness or contrast setting, the image can be permanently imprinted onto the screen. Continuously watching the same channel can cause the imprint of station logos onto the TV screen. These types of imprints are not covered by your warranty because they are the results of misuse.



To reduce the risk of electric shock, do not use this polarized plug with an extension cord, receptacle, or other outlet unless the blades can be fully inserted to prevent blade exposure.



You are cautioned that any changes or modifications not expressly approved in this manual could void your authority to operate this equipment.

NOTIFICATION

This equipment has been tested and found to comply with the limits for a Class B digital device pursuant to Part 15 of the FCC Rules. These limits are designed to provide reasonable protection against harmful interference in a residential installation. This equipment generates, uses, and can radiate radio frequency energy and, if not installed and used in accordance with the instructions, may cause harmful interference with radio communications. However, there is no guarantee that interference will not occur in a particular installation. If this equipment does cause harmful interference to radio or television reception, which can be determined by turning the equipment off and on, the user is encouraged to try to correct the interference by one or more of the following measures:

- Reorient or relocate the receiving antennas.
- Increase the separation between the equipment and receiver.
- Connect the equipment into an outlet on a circuit different from that to which the receiver is connected.
- Consult the dealer or an experienced radio/TV technician for help.

Protecting the TV

- To prevent internal heat build-up, do not block the ventilation openings.
- Do not install the TV in a hot or humid place, or in a place subject to excessive dust or mechanical vibration.

Note on Caption Vision

This television receiver provides display of television closed captioning in accordance with § 15.119 of the FCC rules.

Use of this television for other than private viewing of programs broadcast on UHF or VHF or transmitted by cable companies for the use of the general public may require authorization from the broadcaster-cable company and/or program owner.

Owner's Record

The model and serial numbers are located on the front cover of this manual and the rear of your TV.

Trademarks and Copyrights

ENERGY STAR® is a registered mark.



As an ENERGY STAR® Partner, Sony has determined that this product or product model meets the ENERGY STAR® guidelines for energy efficiency.

Licensed by BBE Sound, Inc. under USP 4638258.4482866. BBE and BBE symbol are trademarks of BBE Sound, Inc.

For KV-24FV12 only

(●)® SRS (SOUND RETRIEVAL)

The (●) SRS (SOUND RETRIEVAL SYSTEM) is manufactured by Sony Corporation under license from SRS Labs, Inc. It is covered by U.S. Patent No. 4,748,669. Other U.S. and foreign patents pending.

The word 'SRS' and the SRS symbol (●) are registered trademarks of SRS Labs, Inc.

Important Safeguards

For your protection, please read these instructions completely, and keep this manual for future reference. Carefully observe and comply with all warnings, cautions, and instructions placed on the set, or described in the operating instructions or service manual.

WARNING

To guard against injury, the following basic safety precautions should be observed in the installation, use, and servicing of the set.

Use

Power Sources

This set should be operated only from the type of power source indicated on the serial/model plate. If you are not sure of the type of electrical power supplied to your home, consult your dealer or local power company. For those sets designed to operate from battery power, refer to the operating instructions.



Grounding or Polarization

This set is equipped with a polarized AC power cord plug (a plug having one blade wider than the other), or with a three-wire grounding type plug (a plug having a third pin for grounding).

Follow the instructions below:

For the set with a polarized AC power cord plug

This plug will fit into the power outlet only one way. This is a safety feature. If you are unable to insert the plug fully into the outlet, try reversing the plug. If the plug should still fail to fit, contact your electrician to have a suitable outlet installed. Do not defeat the safety purpose of the polarized plug by forcing it in.



Alternate Warning

For the set with a three-wire grounding type AC plug

This plug will only fit into a grounding-type power outlet. This is a safety feature. If you are unable to insert the plug into the outlet, contact your electrician to have a suitable outlet installed. Do not defeat the safety purpose of the grounding plug.

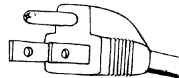

Overloading

Do not overload wall outlets, extension cords or convenience receptacles beyond their capacity, since this can result in fire or electric shock. Always turn the set off when it is not to be used. When the set is left unattended and unused for long periods of time, unplug it from the wall outlet as a precaution against the possibility of an internal malfunction that could create a fire hazard.

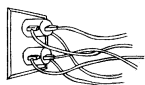

Object and Liquid Entry

Never push objects of any kind into the set through the cabinet slots as they may touch dangerous voltage points or short out parts that could result in a fire or electric shock. Never spill liquid of any kind on the set.



Attachments

Do not use attachments not recommended by the manufacturer, as they may cause hazards.



Cleaning

Unplug the set from the wall outlet before cleaning or polishing it. Do not use liquid cleaners or aerosol cleaners. Use a cloth lightly dampened with water for cleaning the exterior of the set.



If a snapping or popping sound from a TV set is continuous or frequent while the TV is operating, unplug the TV and consult your dealer or service technician. It is normal for some TV sets to make occasional snapping or popping sounds, particularly when being turned on or off.



Installation

Water and Moisture

Do not use power-line operated sets near water — for example, near a bathtub, washbowl, kitchen sink, or laundry tub, in a wet basement, or near a swimming pool, etc.



Accessories

Do not place the set on an unstable cart, stand, tripod, bracket, table, or shelf. The set may fall, causing serious injury to a child or an adult, and serious damage to the set. Use only a cart or stand recommended by the manufacturer for the specific model of TV. Any mounting of the product should follow the manufacturer's instructions, and should use a mounting accessory recommended by the manufacturer. An appliance and cart combination should be moved with care. Quick stops, excessive force, and uneven surfaces may cause the appliance and cart combination to overturn.



Ventilation

The slots and openings in the cabinet and in the back or bottom are provided for necessary ventilation. To ensure reliable operation of the set, and to protect it from overheating, these slots and openings must never be blocked or covered.

- **Never cover the slots and openings with a cloth or other materials.**



- **Never block the slots and openings by placing the set on a bed, sofa, rug or other similar surface.**

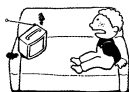

- **Never place the set in a confined space, such as a bookcase, or built-in cabinet, unless proper ventilation is provided.**



- **Do not place the set near or over a radiator or heat register, or where it is exposed to direct sunlight.**



Power-Cord Protection

Do not allow anything to rest on or roll over the power cord, and do not place the set where the power cord is subject to wear or abuse.



Grounding or Polarization

This set may be equipped with a polarized alternating current line plug (a plug having one blade wider than other). This plug will fit into the power outlet only one way. This is a safety feature. If you are unable to insert the plug fully into the outlet, try reversing the plug. If the plug should still fail to fit, contact your electrician to replace your obsolete outlet. Do not defeat the safety purpose of the polarized plug.

Antennas

Outdoor Antenna Grounding

If an outdoor antenna is installed, follow the precautions below. An outdoor antenna system should not be located in the vicinity of overhead power lines or other electric light or power circuits, or where it can come in contact with such power lines or circuits.

WHEN INSTALLING AN OUTDOOR ANTENNA SYSTEM, EXTREME CARE SHOULD BE TAKEN TO KEEP FROM CONTACTING SUCH POWER LINES OR CIRCUITS AS CONTACT WITH THEM IS ALMOST INVARIABLY FATAL.

Be sure the antenna system is grounded so as to provide some protection against voltage surges and built-up static charges. Section 810 of the National Electrical Code (NEC) in USA and Section 54 of the Canadian Electrical Code in Canada provides information with respect to proper grounding of the mast and supporting structure, grounding of the lead-in wire to an antenna discharge unit, size of grounding conductors, location of antenna discharge unit, connection to grounding electrodes, and requirements for the grounding electrode.

Antenna Grounding According to the NEC

Refer to section 54-300 of Canadian Electrical Code for Antenna Grounding.

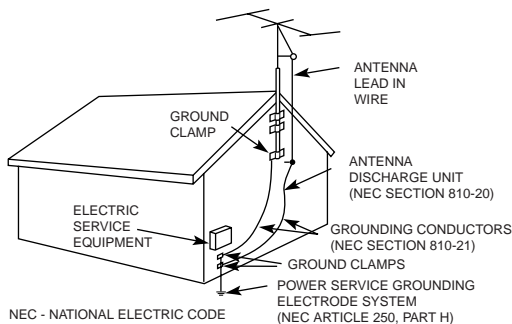

Lightning

For added protection for this television receiver during a lightning storm, or when it is left unattended and unused for long periods of time, unplug it from the wall outlet and disconnect the antenna. This will prevent damage to the receiver due to lightning and power-line surges.

Service

Damage Requiring Service

Unplug the set from the wall outlet and refer servicing to qualified service personnel under the following conditions:

- When the power cord or plug is damaged or frayed.



- If liquid has been spilled into the set or objects have fallen into the product.

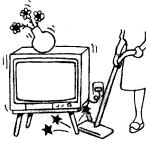

- If the set has been exposed to rain or water.



- If the set has been subject to excessive shock by being dropped, or the cabinet has been damaged.



- If the set does not operate normally when following the operating instructions. Adjust only those controls that are specified in the operating instructions. Improper adjustment of other controls may result in damage and will often require extensive work by a qualified technician to restore the set to normal operation.



- When the set exhibits a distinct change in performance — this indicates a need for service.

Servicing

Do not attempt to service the set yourself since opening the cabinet may expose you to dangerous voltage or other hazards. Refer all servicing to qualified service personnel.



Replacement Parts

When replacement parts are required, be sure the service technician certifies in writing that he has used replacement parts specified by the manufacturer that have the same characteristics as the original parts. Unauthorized substitutions may result in fire, electric shock, or other hazards.



Safety Check

Upon completion of any service or repairs to the set, ask the service technician to perform routine safety checks (as specified by the manufacturer) to determine that the set is in safe operating condition, and to so certify. When the set reaches the end of its useful life, improper disposal could result in a picture tube implosion. Ask a qualified service technician to dispose of the set.



Contents

Introduction

Trinitron® Color TV Features	1
Batteries for the Remote Control.....	2
About this Manual	2







Connecting Your TV

Basic Connections.....	3
Connecting Additional Equipment	4

Using the Remote Control and Basic Functions

Using the Remote Control.....	11
Setting Up the TV Automatically.....	13
Quick Start to the Menus.....	14

Using the Menus

Using the Video  Menu	18
Using the Audio  Menu	19
Options Menu	20
Using the Channel Setup  Menu.....	21
Parental Control.....	22
Using the Parental Control  Menu	25
Using the Timer  Menu	28
Using the Setup  Menu.....	29
Options Menu	30

Other Informations

Programming the Remote Control	31
Troubleshooting	34
Specifications.....	36

Index	37
--------------------	----

Introduction

Congratulations on your purchase of the Sony Trinitron® Color TV. Before you begin using this manual, please check the model number located on the rear of your TV or on the front cover of this manual.

Trinitron® Color TV Features

Some of the features you will enjoy include:

- ❑ **FLAT CRT** — New technologically advanced screen for optimal picture quality.
- ❑ **Parental Control** — A tool for parents to help monitor what their children watch on TV by establishing rating limits.
- ❑ **Favorite Channel** — Instant access to your favorite channels with the touch of a button.
- ❑ **Universal Remote Control** — Program your remote control to operate your connected cable box, VCR, digital satellite receiver, or DVD player.
- ❑ **Energy Star®** — A recognized symbol of energy efficiency.
- ❑ **S VIDEO** — A video input that offers enhanced picture quality.
- ❑ **Direct MTS** — Allows direct access to changing your Multi-Channel TV Sound: Stereo, Mono, or Auto-SAP (Second Audio Program), with the touch of a button.
- ❑ **Trilingual Menus** — Choose between English, French, or Spanish menus.
- ❑ **Front Panel Controls** — Allows access to the on-screen menus without the use of a remote control.
- ❑ **Front A/V inputs** — A quick connection for video games, camcorders, stereo/mono equipment, or headphones.

Batteries for the Remote Control

Insert two AA (R6) batteries (supplied) into the remote control using the following illustration as a guide.

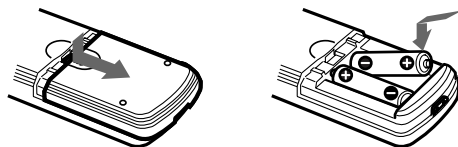

 Under normal conditions, batteries will last up to six months. If the remote control does not operate properly, the batteries might be worn out.

 If you will not be using the remote control for an extended period of time, remove the batteries to avoid possible damage from battery leakage.

 Your remote control can be programmed to operate most video equipment, (see page 31).

About this Manual

This manual provides instructions to help you enjoy your new TV. It shows you how to connect to an antenna or cable, cable box, VCR, DVD, satellite receiver, stereo system, or camcorder. Once you're connected, follow the instructions and use the remote control to access the on-screen menus.

Connecting Your TV

Read this section before setting up your TV for the first time. This section covers basic connections in addition to any optional equipment you may be connecting.

Basic Connections

TV with indoor or outdoor antenna, or CATV cable

Depending on the cable available in your home, choose one of the connections below:

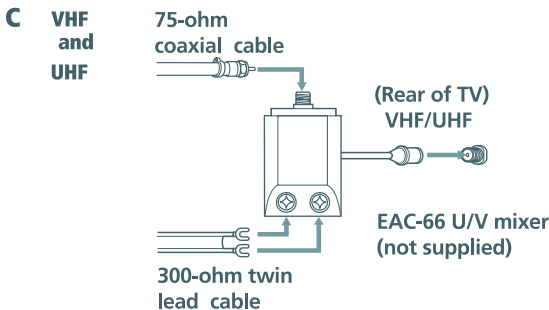
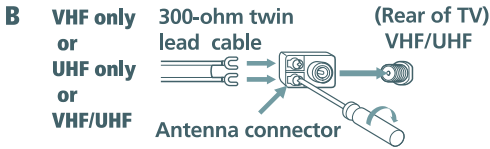
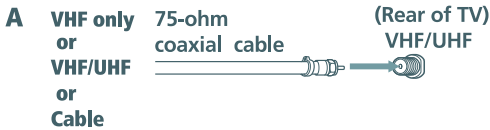

If you are connecting to an indoor or outdoor antenna, you may need to adjust the orientation of the antenna for best reception.

Connecting Additional Equipment

TV and VCR

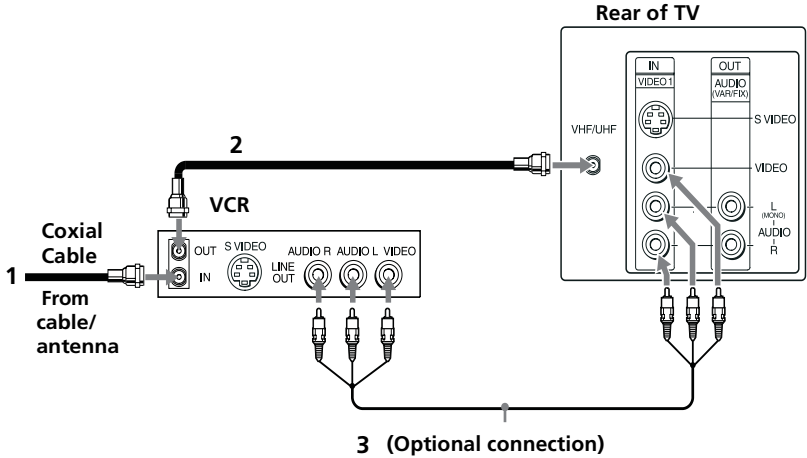



- 1 Connect the coaxial cable from your TV antenna or cable service to the IN jack on your VCR.
- 2 Connect a coaxial cable (not supplied) from the OUT jack on your VCR to the VHF/UHF jack on the TV.

 To watch video programs from your VCR, tune your TV to channel 3 or 4 (as set on the rear of your VCR).

(Optional connection)

- 3 If your VCR is equipped with video outputs, you can get better picture quality by connecting A/V cables (not supplied) from AUDIO and VIDEO OUT on your VCR to AUDIO/VIDEO IN on your TV.

 You can use the  button to switch between the VHF/UHF and VIDEO inputs.

 For optimum picture quality, use S VIDEO (if your VCR is equipped with the S VIDEO connection) instead of the yellow A/V cable. S VIDEO does not provide sound, the audio cables must still be connected.

TV and Cable Box

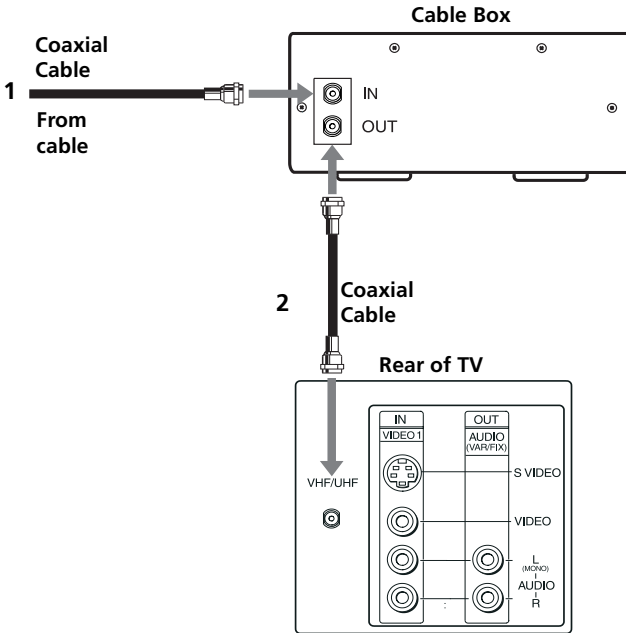

- 1 Connect the coaxial cable from your cable service to the IN jack on your cable box.
- 2 Connect a coaxial cable (not supplied) from the OUT jack on your cable box to the VHF/UHF jack on the TV.

 To view channels from your cable box, tune your TV to channel 3 or 4 (as set on the rear panel of your cable box) and use the cable box's remote control to change channels.

 If you will be controlling all channel selection through your cable box, you should consider using the Channel Fix feature, (see page 21).

TV, VCR, and Cable box

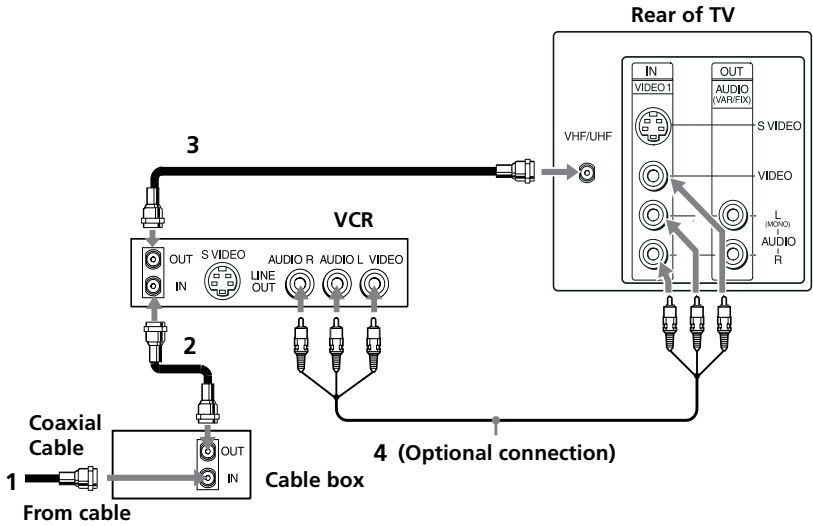



- 1 Connect the coaxial cable from your cable service to the IN jack on your cable box.
- 2 Connect a coaxial cable (not supplied) from the OUT jack on your cable box to the IN jack on your VCR.
- 3 Connect a coaxial cable (not supplied) from the OUT jack on your VCR to the VHF/UHF jack on the TV.

 If you will be controlling all channel selection through your cable box, you should consider using the Channel Fix feature, (see page 21).

(Optional connection)

- 4 If your VCR is equipped with video outputs, you can get better picture quality by connecting A/V cables (not supplied) from AUDIO and VIDEO OUT on your VCR to AUDIO/VIDEO IN on your TV.



 You can use the  button to switch between the VHF/UHF and VIDEO inputs.

 For optimum picture quality, use S VIDEO (if your VCR is equipped with the S VIDEO connection) instead of the yellow A/V cable. S VIDEO does not provide sound, the audio cables must still be connected.

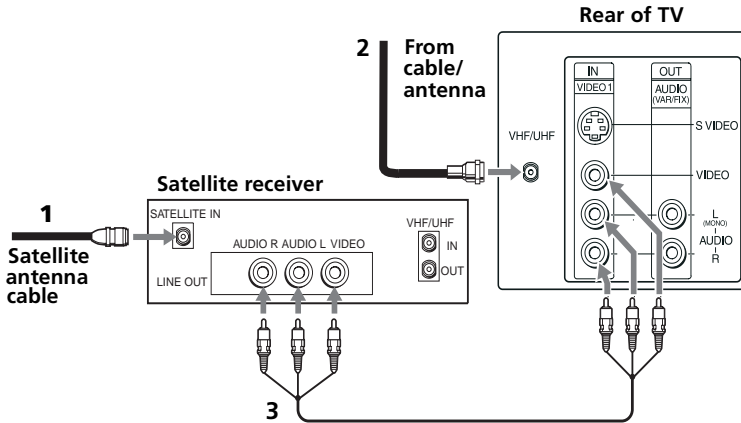
TV and Satellite Receiver



- 1** Connect the cable from your satellite antenna to SATELLITE IN on your satellite receiver.
- 2** Connect the coaxial cable from your cable service or antenna to the VHF/UHF jack on your TV.
- 3** Using A/V cables, connect AUDIO and VIDEO OUT on your satellite receiver to AUDIO and VIDEO IN on your TV.

 You can use the  button to switch between the VHF/UHF and VIDEO inputs.

 For optimum picture quality, use S VIDEO (if your Satellite Receiver is equipped with the S VIDEO connection) instead of the yellow A/V cable. S VIDEO does not provide sound, the audio cables must still be connected.

TV, Satellite Receiver, and VCR

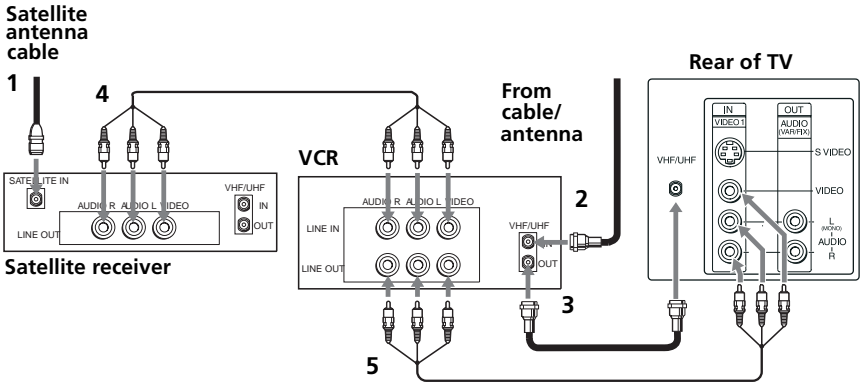

- 1** Connect the cable from your satellite antenna to SATELLITE IN on the satellite receiver.
- 2** Connect the coaxial cable from your cable service or antenna to the IN jack on your VCR.
- 3** Using a coaxial cable, connect the OUT jack on your VCR to the VHF/UHF jack on your TV.
- 4** Using A/V cables, connect AUDIO and VIDEO OUT on your satellite receiver to AUDIO and VIDEO IN on your VCR.
- 5** Using A/V cables, connect AUDIO and VIDEO OUT on your VCR to AUDIO and VIDEO IN on your TV.



To view from the satellite receiver or VCR, select the video input to which your satellite receiver or VCR is connected by pressing **TV/VIDEO** on the remote control.

Connecting a Camcorder

Using A/V cables, connect AUDIO and VIDEO OUT on your camcorder to AUDIO and VIDEO IN on your TV.

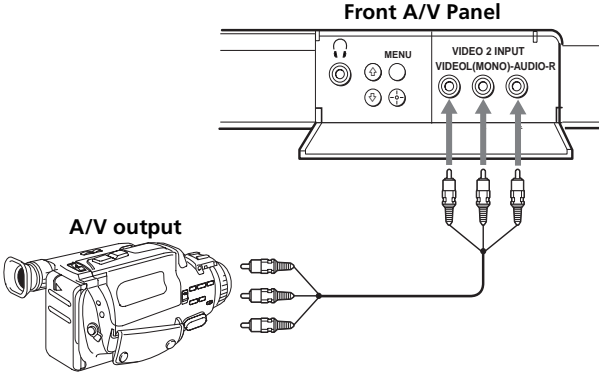

Connecting a DVD Player

- 1 Using audio A/V cables, connect AUDIO OUT on your DVD player to AUDIO IN on your TV.
- 2 Using a S VIDEO cable, connect S VIDEO OUT on your DVD player to S VIDEO IN on your TV.

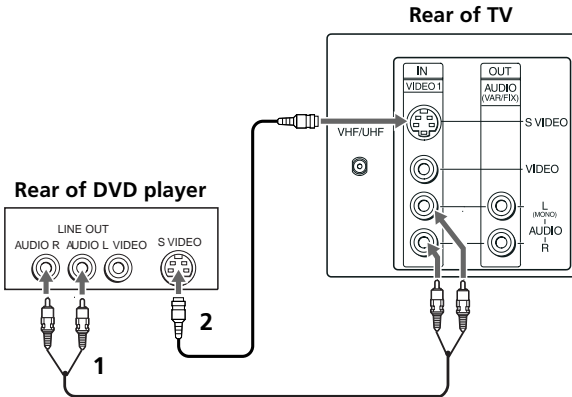



For optimum picture quality, use S VIDEO instead of the yellow A/V cable. S VIDEO does not provide sound, the audio cables must still be connected.

Connecting an Audio System

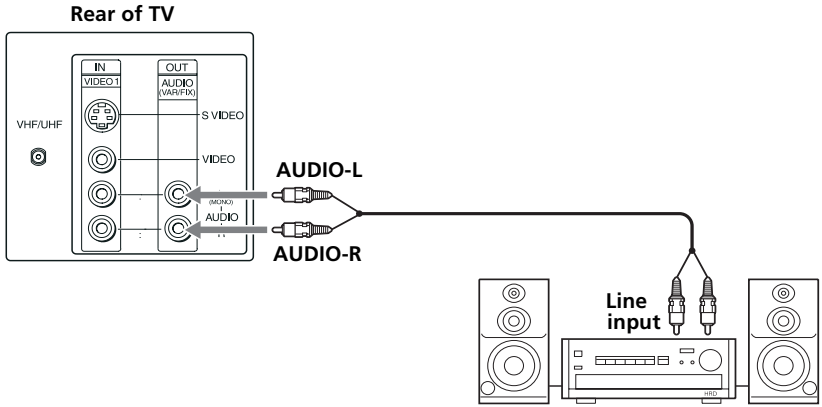
Using A/V cables, connect AUDIO OUT on your TV to one of the unused line inputs (e.g. TV, AUX, TAPE 2) on your stereo.



 To change the level of audio output on your TV can be changed between Fixed and Variable modes, (see page 20).

 Set your stereo to the chosen line input. See page 19 for additional audio setup instructions.

Connecting Headphones

Connect the headphones to the  jack on the front of your TV.

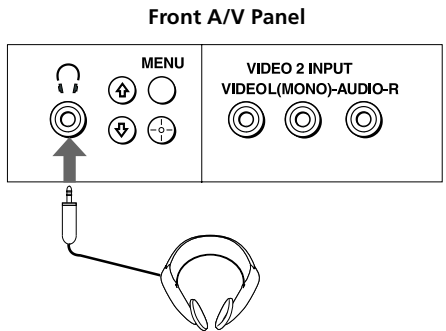

Using the Remote Control and Basic Functions

This section shows you how to use the more advanced buttons on the remote control and how to use the on-screen menus.

Using the Remote Control

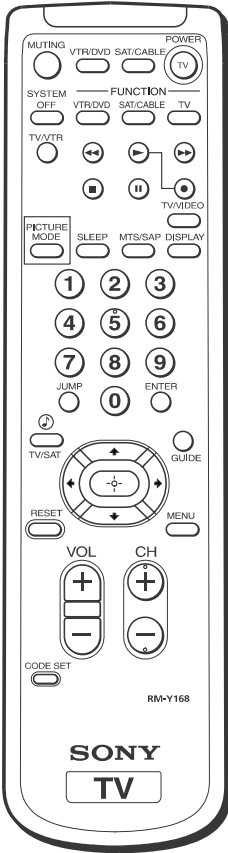

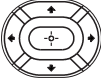
Button	Description
POWER	Press when you want to turn connected equipment on and off.
FUNCTION	Press when you want to control connected equipment with your remote control.
MUTING	Instantly turns off the sound. Press again or press $\text{VOL} \uparrow$ to restore sound.
SYSTEM OFF	Powers off all Sony equipment at once, (may not work with older equipment).
TV/VIDEO	Cycles through available video inputs.
TV/VTR	Press when you are finished using a VCR and you want to switch to the TV input. Your VCR power will remain on.
	Moves the cursor in the on-screen menu. Press the arrow buttons to move the cursor, press the center button to select or access an option.
PICTURE MODE	Cycles through the available Video Mode settings.
SLEEP	Turns the TV off automatically in approximately 15, 30, 45, 60, or 90 minutes. Cancel by pressing until SLEEP OFF appears.

(continued)

MTS/SAP	Cycles through the Multi-channel TV Sound (MTS) options: Stereo, Mono, and Auto-SAP (Second Audio Programming).
DISPLAY	Press to display the current time, (if set) and channel number.
	Cycles through available Steady Sound settings, (see page 19).
JUMP	Alternates between the last two channels selected with the 0 - 9 buttons.
GUIDE	Brings up the custom guide of your satellite receiver.
MENU	Displays the on-screen menu. Press again to exit the menu at any time.
RESET	Press to return to factory settings while in an on-screen menu.
CODE SET	Use to program your remote control to operate connected video equipment, (see page 31).





If you lost your remote control, see page 35.

Setting Up the TV Automatically



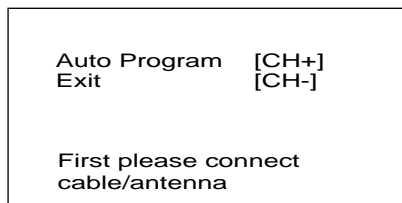













After you have finished connecting your TV, you can perform Auto Program to set up your channels.

- 1 Press  to turn on the TV. The Initial Setup screen appears.



- 2 Press  on the remote control or in the TV front panel to perform Auto Program.

To perform Auto Program again





























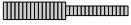



























- 1 Press .
- 2 Press  to highlight setup ().
- 3 Press  to highlight Options. Press  or  to select.
- 4 Press  to select Cable. Press  or  to select.
- 5 Press  or  to select ON or OFF according to how you connected your TV. Press  or .
- 6 Press  to highlight Auto Program. Press  or  to search for channels.



The Initial Setup screen appears each time you turn on the TV until you perform Auto Program.

Quick Start to the Menus

The following settings are available in your on-screen menus:

Menu	Allows you to
      Video Mode: Vivid Picture Controls VM: High Move     Select  End 	Make adjustments to your picture settings.
      Audio Treble  Bass  Balance  Steady Sound: OFF Effect: OFF Options Move     Select  End 	Options MTS: Auto-SAP Speaker: OFF Audio Out: Variable Move     Select  End 
      Channel Setup Favorite Channel Channel Fix: OFF Channel Skip/Add Channel Label Move     Select  End 	Customize your channel settings.
      Parental Control Password: █_ _ _ _ Move     Select  End 	Set rating limits on your TV based on a program's rating or content.

Menu

Allows you to

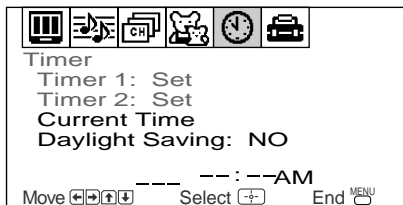

Set the clock on your TV and program scheduled viewing using Timer 1 and Timer 2.

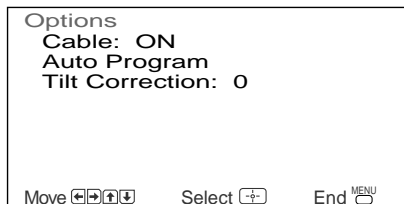











Program your channels, lable video inputs, select menu languages, or run a demo of the menus.

The Options menu offers other setup options.

Using the Menus

This section shows the options available for setting up and adjusting your TV.

To access a menu

- 1** Press .
- 2** Use the  or  buttons to move through the menus.
- 3** Use the  or  buttons to highlight an option.
- 4** Press  or  to select or access an option.
- 5** After adjusting or selecting an option, press  or  to complete the adjustment.
- 6** Press  to go to the previous menu, or press  to close the menu.

Using the Video Menu

To access the Video menu, see “To access a menu” on page 17.



Mode

Customized picture viewing

Vivid: Select for enhanced picture contrast and sharpness.
Movie: Select for a finely detailed picture.
Sports: Select for a bright picture.
Standard: Select for a standard picture.



Press



for direct Mode settings, (Vivid, Movie, Sports, Standard).

Picture Controls

With the Picture Controls menu open:

Picture: Press \leftarrow or \downarrow to decrease the contrast. Press \rightarrow or \uparrow to increase contrast.

Brightness: Press \leftarrow or \downarrow to darken the picture. Press \rightarrow or \uparrow to brighten the picture.

Color: Press \leftarrow or \downarrow to decrease color saturation. Press \rightarrow or \uparrow to increase color saturation.

Hue: Press \leftarrow or \downarrow to decrease the red tones. Press \rightarrow or \uparrow to increase the green tones.

Sharpness: Press \leftarrow or \downarrow to soften the picture. Press \rightarrow or \uparrow to sharpen the picture.

VM

Velocity Modulation

Sharpens picture definition to give objects a sharp, clean edge. Use the \uparrow or \downarrow buttons to select from one of the following options: **OFF, High, Low.**



When you change the Mode setting the VM setting may also change automatically.

Using the Audio Menu

To access the Audio menu, see “To access a menu” on page 17.

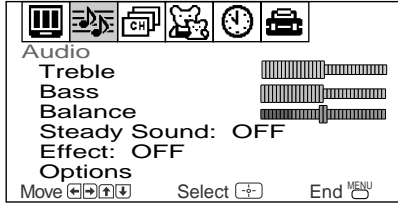

Treble	Press \leftarrow or \downarrow to decrease the higher pitched sound. Press \rightarrow or \uparrow to increase the higher pitched sound.
Bass	Press \leftarrow or \downarrow to decrease the lower pitched sound. Press \rightarrow or \uparrow to increase the lower pitched sound.
Balance	Press \leftarrow or \downarrow to emphasize the left speaker. Press \rightarrow or \uparrow to emphasize the right speaker.
Steady Sound <i>Stabilizes volume</i>	Press \uparrow or \downarrow to select one of the following options: ON: Select to stabilize the volume when changing channels. OFF: Select to turn Steady Sound off.



Press  for direct Steady Sound settings.

Effect	Press \uparrow or \downarrow to select one of the following options: SRS: Produces a dynamic three dimensional sound for stereo audio signals, (KV-24FV12 only). Simulated: Simulates theater quality sound for stereo programs, (KV-24FV12 only). Surround: Add a surround-like effect to mono programs, (KV-20FV12 only). OFF: Normal stereo or mono reception.
---------------	---

Options Menu

To access the Options menu, see “To access a menu” on page 17.

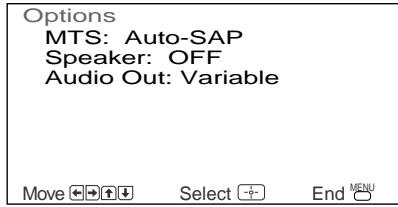

<p>MTS <i>Multi-Channel Sound</i></p>	<p>Press \uparrow or \downarrow to select one of the following options: Stereo: Select when viewing a broadcast in stereo. Mono: Select to reduce noise in areas of poor reception. Auto-SAP: Select to have the TV automatically to a Second Audio Program (SAP) when a signal is received.</p>
<p>Speaker <i>Custom selection of audio output source</i></p>	<p>ON: Select to listen to the sound from the TV speakers with or without a separate stereo system. OFF: Select to turn off the TV speakers and listen to the TV's sound only through external audio system speakers.</p>
<p>Audio Out <i>Use to control the TV's volume through a stereo</i></p>	<p>Audio Out can only be set when speakers are set to OFF. Variable: Adjust the volume through your TV. Fixed: Adjust the TV volume through a connected stereo.</p>

 If your TV is set to Auto-SAP, some programs may be muted or distorted. If your TV does not output sound, change your Audio setting to Stereo or Mono.

 Press MTS/SAP for direct MTS settings (Stereo, Mono, Auto-SAP).

 Audio Out can only be set when Speaker is set to OFF.

Using the Channel Setup Menu

To access the Channel Setup menu, see “To access a menu” on page 17.



Favorite Channel

Quick access to favorite channels

With the Favorite Channel menu open:

- 1 Press \leftarrow or \rightarrow to select.
- 2 Use the \uparrow or \downarrow buttons to select Auto or Manual (selecting Auto will display in gray the last five channels accessed by the 0-9 buttons).
- 3 When in Manual, press \leftarrow then \downarrow to select the position (1-5) where you want to set a favorite channel. Then press \rightarrow or \rightarrow .
- 4 Using the \uparrow or \downarrow buttons, select the desired channel.
- 5 Press MENU then MENU , the TV will change to the channel entered.



To use Favorite Channel: Exit all menus and press \rightarrow . Press \uparrow or \downarrow to move the cursor to the desired channel number and press \rightarrow .

Channel Fix

2-6: Select when you want to control all channel selection through a cable box or VCR. Select the appropriate channel (usually 3 or 4) and use the cable box's or VCR's remote control for channel selection.

Video: Select from available video inputs when you have connected video equipment (e.g. satellite receiver) and you want your TV fixed to it.

OFF: Channel Fix is not set.

Channel Skip/Add

Use this feature after you run Auto Program to skip unwanted channels or add new ones.

- 1 Use the 0-9 buttons or the [CH +/-] buttons to select the channel, then press MENU .
- 2 Press \rightarrow to Skip or Add (only one option will be available).

Channel Label

Label up to 40 channels with their call letters

With the Channel Label window open:

- 1 Press \rightarrow , then press \uparrow or \downarrow until you reach the desired channel number.
- 2 Press \rightarrow to activate the channel.
- 3 Press \uparrow or \downarrow to display the first call letter or number of the caption and press MENU to select it. When finished, press \rightarrow or \rightarrow to activate.



Favorite Channel, Channel Skip/Add, and Channel Label cannot be used when Channel Fix is set.

Parental Control

The Parental Control feature is designed to help parents monitor what their children watch on television. This section shows you the different rating systems available and how to set your TV's rating limit.

Overview of the Ratings

Once you have become familiar with these rating systems, you should be ready to set your TV's rating limit.

TV Ratings

The TV ratings are divided into two groups: age-based and content-based.

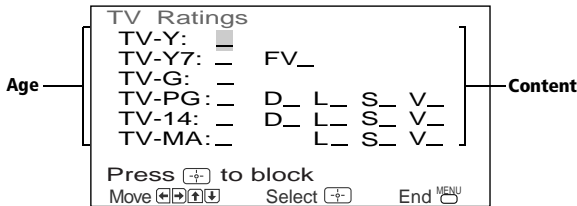

Age	Defined as
TV-Y	All children
TV-Y7	Directed to older children
TV-G	General audience
TV-PG	Parental Guidance suggested
TV-14	Parents Strongly cautioned
TV-MA	Mature Audience only

Contents	Defined as
FV	Fantasy Violence
D	Suggestive dialogue
L	Strong language
S	Sexual situations
V	Violence

The content ratings will increase depending on the level of the age-based rating. For example, a program with a TV-PG V (Violence) rating may contain moderate violence, while a TV-14 V (Violence) rating may contain intense violence.

Movie Ratings

(U.S. models only)

This system defines the rating levels of movies shown in theaters and on prime cable channels.

Rating	Defined as
G	General audience
PG	Parental Guidance suggested
PG-13	Parents strongly cautioned
R	Restricted
NC-17	No one 17 and under admitted
X	No one 17 and under admitted

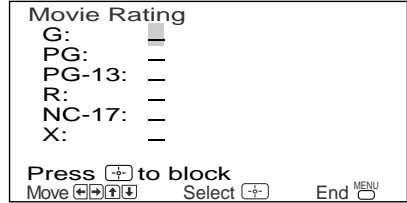

Unrated

(U.S. models only)

You have the option of blocking TV programs or movies that are not rated.

View All	Allows all unrated programs
Block All	Blocks all unrated programming
Block TV	Blocks all unrated TV Programs
Block Movies	Blocks all unrated movies



If you choose to block unrated TV programs, please be aware that the following programs may be blocked: emergency broadcasts, political programs, sports, news, public service announcements, religious programs, and weather.

English Ratings

(Canadian models only)

These ratings are for Canadian programs that are broadcast in English.

Rating	Defined as
C	Children
C8+	Children 8 years and older
G	General programming
PG	Parental Guidance
14+	Viewers 14 and older
18+	Adult programming

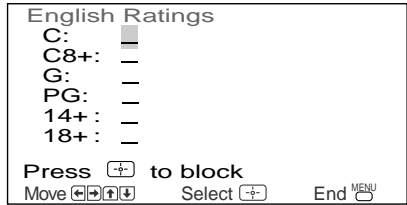

French Ratings

(Canadian models only)

These ratings are for Canadian programs that are broadcast in French.

Rating	Defined as
G	General
8 ans+	Not recommended for younger children
13 ans+	Not recommended for children under age 13
16 ans+	Not recommended for ages under 16
18 ans+	This program is restricted to adults

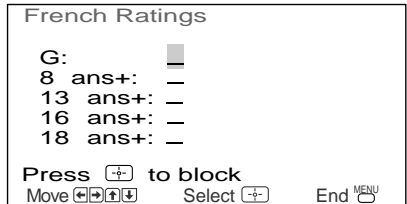

U.S.A. Ratings

(Canadian models only)





For programs from the United States. Please see “TV Ratings” on page 22.

Using the Parental Control Menu

To access the Parental Control menu, see “To access a menu” on page 17.



In the Parental Control  menu, you will be asked to set a 4-digit password for any further access into Parental Control.

- 1 Press  or , then use the - buttons to enter a 4-digit password.

 Keep this manual in a safe place. If you forget your password, see page 37.

- 2 Confirm your password by entering it again.

Once your password is set correctly, the next Parental Control menu appears.

Setting the rating

You can change the Rating by selecting one of the Lock options.



1 Move the cursor to Lock and press \Rightarrow or \leftarrow .

If you are not familiar with the Parental Guidelines rating system, use one of the following preselected categories to simplify the rating selections: OFF, Child, Youth, Young Adult, or Custom.

2 Use the \uparrow or \downarrow buttons to select the desired rating and press \Rightarrow or \leftarrow .



Rating	TV will allow a maximum rating of:
Child	TV-Y, TV-G, G (U.S. models only), G (Canadian models only)
Youth	TV-PG, PG (U.S. models only), PG (Canadian models only)
Young Adult	TV-14, PG-13 (U.S. models only), 14+ (Canadian models only)
Custom	Select to set more restrictive ratings, (see next section)
OFF	No rating limit

Using the Custom menu

Before setting Custom ratings, see page 22-24, “Overview of the Ratings,” for a description of the available rating systems.

Follow the instructions on the screen to make your custom settings. See page 23 for U.S. models and page 24 for Canadian models for more information.



Once you have blocked a rating or content, all higher ratings or content will be automatically blocked.

Changing your Password

- 1 Use the \uparrow or \downarrow buttons to move the cursor to Change Password and press \rightarrow or \leftarrow .
- 2 Follow step 2 and 3 for “Using the Parental Control menu” on page 25.

Information for Parents

To view a program that exceeds the TV rating

- Press ENTER \bigcirc , then use the 0-9 buttons to enter your password.



Entering your password to view a blocked program will temporarily turn Lock to OFF. To reactivate your Lock settings, turn the TV off then back on. The TV will return to the settings that you have selected.

Using the Timer Menu

To access the Timer menu, see “To access a menu” on page 17.

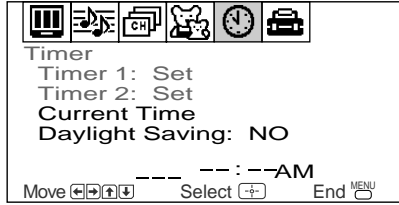

Timer 1 and Timer 2

*Scheduled
viewing*

With the menu open, highlight Timer 1 or Timer 2:

- 1 Press \leftarrow or \rightarrow , then press \uparrow or \downarrow again.
- 2 Press \uparrow or \downarrow until the desired day or range of days is displayed, then press \leftarrow or \rightarrow .
- 3 Press \uparrow or \downarrow to select the hour you want the TV to turn on, then press \leftarrow or \rightarrow .
- 4 Press \uparrow or \downarrow to select the minute you want the TV to turn on, then press \leftarrow or \rightarrow .
- 5 Press \uparrow or \downarrow to set the duration (up to 6 hours) then press \leftarrow or \rightarrow .
- 6 Press \uparrow or \downarrow to set the channel and press \leftarrow or \rightarrow .



You must set the Current Time before you can use Timer 1 and Timer 2.

Current Time

With the menu open:

- 1 Press \leftarrow or \rightarrow .
- 2 Press \uparrow or \downarrow to select the day and press \leftarrow or \rightarrow .
- 3 Press \uparrow or \downarrow until the current hour is displayed, then press \leftarrow or \rightarrow .
- 4 Press \uparrow or \downarrow until the current minute is displayed, then press \leftarrow or \rightarrow .

Daylight Saving

YES: Select in spring to compensate for Daylight Saving.
NO: Select in fall at the end of Daylight Saving.



When you perform Auto Program, all Timer 1 and Timer 2 settings will be cleared.



Any loss of power will cause the Timer 1 and Timer 2 settings to be cleared.

Using the Setup Menu

To access the Setup menu, see “To access a menu” on page 17.



Caption Vision <i>Closed-Captioning</i>	Press \uparrow or \downarrow to select one of the following options: CC1, 2, 3, 4: Displays printed dialogue and sound effects of a program. TEXT1, 2, 3, 4: Displays network/station information. XDS (Extended Data Services): Displays information about the network and current program, if available. OFF: Caption vision is not activated.
Video Label <i>Label connected equipment</i>	With the Video Label window open: 1 Press \uparrow or \downarrow to access the input you want to label and press \rightarrow or \leftarrow . 2 Press \uparrow or \downarrow to choose a label and press \rightarrow or \leftarrow .
Language	Display all menus in your language of choice. Use the \uparrow or \downarrow buttons to select desired language and press \rightarrow or \leftarrow .
Demo	Press \rightarrow or \leftarrow to run a demonstration of the on-screen menus.

Options Menu

To access the Options menu, see “To access a menu” on page 17.

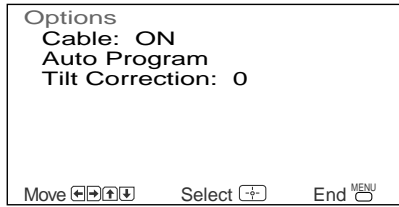

Cable **ON:** Select if you are receiving cable channels with a CATV cable.

OFF: Select if you are using a TV antenna.

 After changing your cable settings, you will need to perform Auto Program.







Auto Program Perform Auto Program whenever setting up your TV. It will cycle through all available channels and program receivable channels.

Tilt Correction Press \updownarrow or \updownarrow to correct any tilt of the picture from -5 to +5, then press \leftrightarrow or \leftrightarrow to activate.

Other Information

Programming the Remote Control

You can use the supplied remote control to operate Sony and non-Sony video equipment.

- 1 Press .
- 2 Press  or  (FUNCTION).
- 3 Use the - buttons to key in the code number from the following chart.
- 4 Press .

VCR codes

Sony	301, 302, 303	JCPenney	309, 305, 304, 330, 314, 336, 337
Admiral (M.Ward)	327	JVC	314, 336, 337, 345, 346, 347
Aiwa	338, 344	Kenwood	314, 336, 332, 337
Audio Dynamic	314, 337	LXI (Sears)	332, 305, 330, 335, 338
Broksonic	319, 317	Magnavox	308, 309, 310
Canon	309, 308	Marantz	314, 336, 337
Citizen	332	Marta	332
Craig	302, 332	Memorex	309, 335
Criterion	315	Minolta	305, 304
Curtis Mathis	304, 338, 309	Mitsubishi/MGA	323, 324, 325, 326
Daewoo	341, 312, 309	Multitech	325, 338, 321
DBX	314, 336, 337	NEC	314, 336, 337
Dimensia	304	Olympic	309, 308
Emerson	319, 320, 316, 317, 318, 341	Optimus	327
Fisher	330, 335	Panasonic	308, 309, 306, 307
Funai	338	Pentax	305, 304
General Electric	329, 304, 309	Philco	308, 309
Go Video	322, 339, 340	Philips	308, 309, 310
Goldstar	332	Pioneer	308
Hitachi	306, 304, 305, 338	Quasar	308, 309, 306
Instant Replay	309, 308	RCA/PROSCAN	304, 305, 308, 309, 311, 312, 313, 310, 329

VCR codes

Realistic	309, 330, 328, 335, 324, 338
Sansui	314
Samsung	322, 313, 321
Sanyo	330, 335
Scott	312, 313, 321, 335, 323, 324, 325, 326
Sharp	327, 328
Shintom	315
Signature 2000 (M.Ward)	338, 327
SV2000	338
Sylvania	308, 309, 338, 310

Cable Box codes

Hamlin/Regal	222, 223, 224, 225, 226
Jerrold/G. I.	201, 202, 203, 204, 205, 206, 207, 208, 218
Oak	227, 228, 229
Panasonic	219, 220, 221
Pioneer	214, 215
Scientific Atlanta	209, 210, 211
Tocom	216, 217
Zenith	212, 213

Laser Disc Player codes

Sony	701
Panasonic	704, 710
Pioneer	702

Symphonic	338
Tashiro	332
Tatung	314, 336, 337
Teac	314, 336, 338, 337
Technics	309, 308
Toshiba	312, 311
Wards	327, 328, 335, 331, 332
Yamaha	314, 330, 336, 337
Zenith	331

Satellite Receiver codes

Sony	801 (preset code for remote control)
General Electric	802
Hitachi	805
Hughes	804
Panasonic	803
RCA/PROSCAN	802, 808
Toshiba	806, 807

DVD codes

Sony	751
Panasonic	753
Pioneer	752
RCA	755
Toshiba	754











If more than one code number is listed, try entering them one by one until you come to the correct code for your equipment.





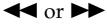





Whenever you remove the batteries, the code numbers may revert to the factory setting and must be reset.

 In some rare cases, you may not be able to operate your equipment with the supplied remote control. In this case, use the equipment's supplied remote control.





Operating a VCR

Press	To
	Power on the VCR
	Select channels directly
	Change channels
	Play video tape
	Stop
	Search forward or backward
	Pause
	Record
at the same time	
	Change between VCR and TV inputs

Operating a DVD

Press	To
	Power on the DVD
	Select chapters directly
	Search chapters forward or backward
	Play DVD
	Stop
	Pause
	Move the cursor in the menu
	Display the DVD menu











Operating a Laser Disc

Press	To
	Power on the laser disc
	Search chapters forward or backward
	Play disc
	Stop
	Pause

Troubleshooting

If you are having a problem with your TV, try the suggestions below. If the problem persists, contact your nearest Sony dealer.

No picture, no sound	<ul style="list-style-type: none"> <input type="checkbox"/> Make sure the power cord is plugged in. <input type="checkbox"/> If a red light is flashing on the front of your TV for more than a few minutes, disconnect and reconnect the power cord to restore the TV. If the problem continues, call your local service center. <input type="checkbox"/> Check the TV/VIDEO settings: when watching TV, set to TV; when watching video equipment, set to VIDEO (page 11). <input type="checkbox"/> Make sure the batteries have been inserted correctly into the remote control (page 2). <input type="checkbox"/> Try another channel, it could be station trouble.
Poor or no picture, good sound	<ul style="list-style-type: none"> <input type="checkbox"/> Adjust Picture in the Video menu (page 18). <input type="checkbox"/> Adjust Brightness in the Video menu (page 18). <input type="checkbox"/> Check the antenna and/or cable connections (page 3).
Good picture, no sound	<ul style="list-style-type: none"> <input type="checkbox"/> Press MUTING so that MUTING disappears from the screen (page 11). <input type="checkbox"/> Check your Audio settings. Your TV may be set to Auto-SAP (page 20).
No color	<ul style="list-style-type: none"> <input type="checkbox"/> Adjust Color in the Video menu (page 18).
Only snow appears on the screen	<ul style="list-style-type: none"> <input type="checkbox"/> Check the Cable setting in the Options menu under Setup (page 30). <input type="checkbox"/> Check the antenna and/or cable connections (page 3). <input type="checkbox"/> Make sure the channel selected is currently broadcasting.
Dotted lines or stripes	<ul style="list-style-type: none"> <input type="checkbox"/> Adjust the antenna. <input type="checkbox"/> Move the TV away from other electronic equipment. Some electronic equipment can create electrical noise, which can interfere with TV reception.
Double images or ghosts	<ul style="list-style-type: none"> <input type="checkbox"/> Check your outdoor antenna or call your cable service.

Cannot receive higher number channels (UHF) when using an antenna	<ul style="list-style-type: none"> ❑ Make sure Cable is set to OFF in the Options menu under Setup (page 30). ❑ Perform Auto Program to add channels that are not presently in the memory (page 13).
Cable stations don't seem to work	<ul style="list-style-type: none"> ❑ Make sure Cable is set to ON in the Options menu under Setup (page 30). ❑ Perform Auto Program to add channels that are not presently in the memory (page 13).
Remote control does not operate	<ul style="list-style-type: none"> ❑ Batteries could be weak. Replace them (page 2). ❑ Move the TV 3-4 or more feet away from fluorescent lights.
The TV needs to be cleaned	<ul style="list-style-type: none"> ❑ Clean the TV with a soft dry cloth. Never use strong solvents such as thinner or benzine, which might damage the finish of the cabinet.
Lost password for Parental Control	<ul style="list-style-type: none"> ❑ In the password screen, enter the following master password: 4357. After using the master password, you must create a new password, it cannot be used to unlock currently blocked channels.
You lost your remote control	<ul style="list-style-type: none"> ❑ You can use the front A/V panel controls to access the menu. Press  to open the menu. Use the  and  buttons on the front A/V panel instead of the  and  buttons on the remote control. Use the  button on the front A/V panel instead of the , , and  buttons on the remote control. Press  again when the setting or adjustment is complete. Contact your nearest Sony dealer to order a replacement. Should you require further assistance, please call the Sony Technical Support number for your country. One of Sony's Technical Support professionals will be happy to assist you.

If, after reading these Operating Instructions, you have additional questions related to the use of your Sony television, please call our Direct Response Center at 1-800-222-SONY (7669) (U.S. residents only) or (416) 499-SONY (7669) (Canadian residents only).

Specifications

For all models (except as noted)

Television system	American TV standard/NTSC
Channel coverage	VHF: 2-13/UHF: 14-69/CATV: 1-125
Antenna	75-ohm external antenna terminal for VHF/UHF
Picture tube	FD Trinitron® tube
Power requirements	120V, 60 Hz
Supplied Accessories	Size AA (R6) batteries (2) Remote Control RM-Y168 (1)
Optional Accessories	Connecting cables VMC-810S/820S, VMC-720M, YC-YC-15V/30V, RK74A EAC-66 U/V mixer
Inputs/outputs	2 video, 2 audio 1 S VIDEO 1 AUDIO OUT 1 headphone jack

KV-20FV12

Screen size	Visible screen size: 20 inches (508.0 mm) measured diagonally Actual tube size: 21 inches (533.4 mm) measured diagonally
Speaker output	5 W x 2
Dimensions (W/H/D)	562 x 466 x 503 mm (22 ¹ / ₄ x 18 ³ / ₈ x 19 ⁷ / ₈ in.)
Mass	27 kg (59 lbs. 8 oz.)
Power Consumption	115 W in use 1 W in standby

KV-24FV12

Screen size	Visible screen size: 24 inches (598.0 mm) measured diagonally Actual tube size: 25 inches (623.4 mm) measured diagonally
Speaker output	10 W x 2
Dimensions (W/H/D)	652 x 524.3 x 467.3 mm (25 ³ / ₄ x 20 ³ / ₄ x 18 ³ / ₈ in.)
Mass	37 kg (81 lbs. 9 oz.)
Power Consumption	170 W in use 1 W in standby

Design and specifications are subject to change without notice.

Index

A

- Audio  menu 19
- Audio out 20
- Auto Program 13, 30
- Auto-SAP 20

B

- Balance 19
- Bass 19
- Battery Installation 2
- Brightness 18

C

- Cable 30
- Cable box code number 32
- Caption Vision 29
- Channel Fix 21
- Channel Label 21
- Channel Setup  menu 21
- Channel Skip/Add 21
- Color 18
- Code numbers
 - Cable box 32
 - DVD 32
 - Laser Disc Player 32
 - Satellite Receiver 32
 - VCR 31, 32
- Connections
 - Cable and antenna 3
 - Connecting an Audio System 10
 - Connecting a Camcorder 9
 - Connecting a DVD player 9
 - Connecting Headphones 10
 - TV and Cable Box 5
 - TV and VCR 4
 - TV and Satellite Receiver 7
 - TV, Satellite Receiver, and VCR 8
 - TV, VCR, and Cable box 6
- Current Time 28

D

- Daylight Saving 28
- Demo 29
- DVD code number 32
- Satellite Receiver code number 32

E

- Effect 19
 - OFF 19
 - Simulated 19
 - SRS 19

F

- Favorite Channel 21







H

- Hue 18

L

- Language 29
- Laser Disc Player code number 32

M

- Menus
 - Audio  19
 - Channel Setup  21
 - Bloqueo de Canal  25
 - Setup  29
 - Timer  28
 - Video  18
- Mode 18
 - Vivid 18
 - Movie 18
 - Sports 18
 - Standard 18
- MTS 20
 - Auto-SAP 20
 - Main 20
 - Mono 20

O

- Options (Audio) 20
- Options (Setup) 30

P

- Parental Control  Menu 25
- Picture 18

R

Remote Control 11

S

Setting up the TV

Automatically 13

Setup  menu 29

Sharpness 18

Speaker 20

Specifications 38

Steady Sound 19

T

Timer  menu 28

Timer 1 and Timer 2 28

Treble 19

Troubleshooting 34

TV Features 1

Tilt Correction 30

V

VCR code number 31, 32

Video  menu 18

Video Label 29

VM 18

