

Trinitron Color TV

Operating Instructions

####

####

E

C1

C2

KV-EF29

M80
M90
M61
M91

WARNING

- Dangerously high voltages are present inside the TV.
- Operate the TV only between 110 – 240 V AC.

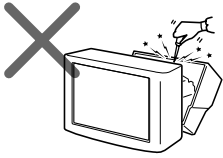

Do not open the cabinet and the rear cover of the TV. Refer servicing to qualified personnel.

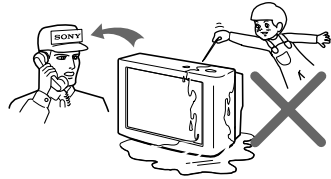

Do not operate the TV if any liquid or solid object falls into it. Have it checked immediately by qualified personnel only.

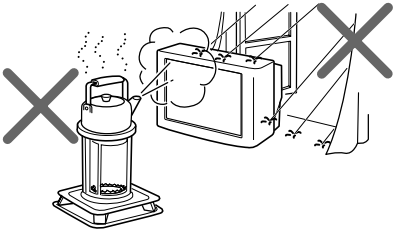

To prevent fire or shock hazard, do not expose the TV to rain or moisture.

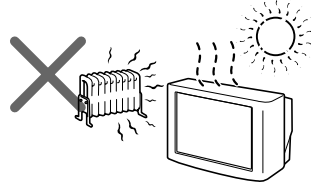

Do not install the TV in hot, humid or excessively dusty places.

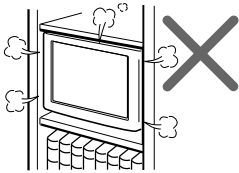

Do not install the TV in a confined space, such as a bookcase or built-in cabinet. Do not block the ventilation openings of the TV.

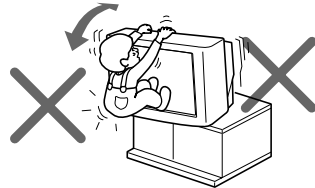

Install the TV in a stable position. Do not allow children to climb onto it.

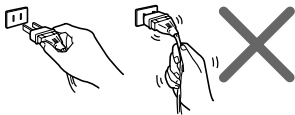

Do not pull the power cord to disconnect the TV. Pull it out by the plug.

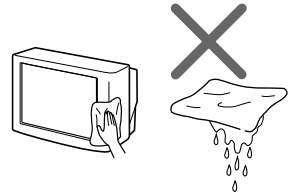

Clean the TV with a dry and soft cloth. Do not use benzine, thinner, or any other chemicals to clean the TV. Do not scratch the picture tube.

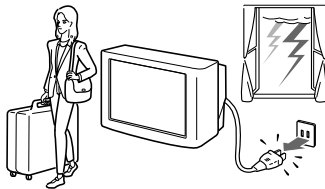

Disconnect the power cord during lightning storms or if you are not going to use the TV for several days.

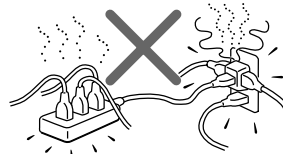

Do not plug in too many appliances to the same power socket. Do not damage the power cord.

Table of Contents

WARNING

Using Your New TV





Getting Started	4
Step 1: Connect the antenna	4
Step 2: Insert the batteries into the remote	5
Step 3: Preset the channels	5
Connecting optional components	6
Securing the TV	8
Watching the TV	9

Advanced Operations

Listening with dynamic sound —DYNAMIC POWER BASSO	12
Listening with Virtual Dolby Surround sound	13
Watching two programs at the same time—PIP	14
Viewing multiple programs at the same time—PROGRAM INDEX	16
Selecting a stereo or bilingual program (KV-EF29M61/EF29M91/ EF29M90 only)	18
Viewing Teletext (KV-EF29M61/ EF29M91 only)	20
Displaying Teletext on the PIP screen—PIP TEXT (KV-EF29M61/ EF29M91 only)	22
Viewing a video game screen —GAME MODE	23

Operating optional components	24
-------------------------------------	----

Adjusting Your Setup (MENU)

Introducing the menu system	26
Changing the menu language	27
Adjusting the A/V CONTROL setting 	28
Adjusting the PIP setting 	30
Adjusting the FEATURES setting 	32
Adjusting the PRESET setting 	34

Additional Information

Troubleshooting	37
Identifying parts and controls	39
Specifications	Back cover

Here are some fun features of your TV:

- VIRTUAL DOLBY SURROUND (page 13)
- DYNAMIC POWER BASSO (page 12)
- HYPER SURROUND (page 32)
- PROGRAM INDEX (page 16)
- STROBE (page 31)
- PIP (page 14)
- PIP TEXT (page 22)
(KV-EF29M61/EF29M91 only)
- GAME MODE (page 23)
- Menu language—English/Chinese (page 27)

Getting Started

Step 1

Connect the antenna



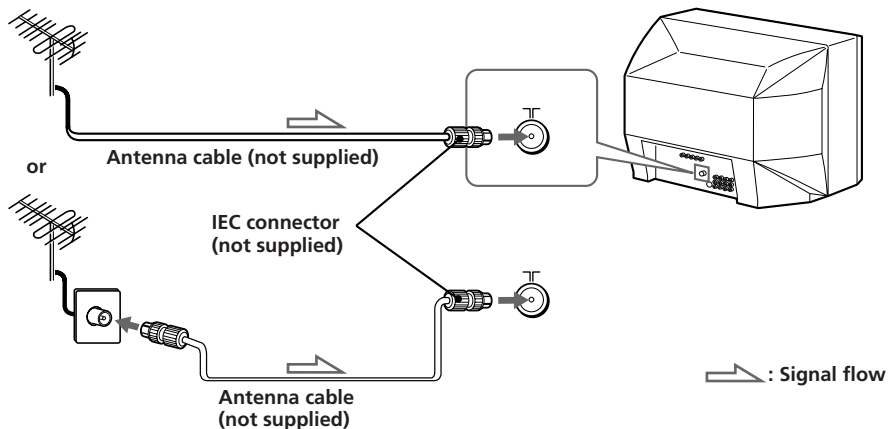



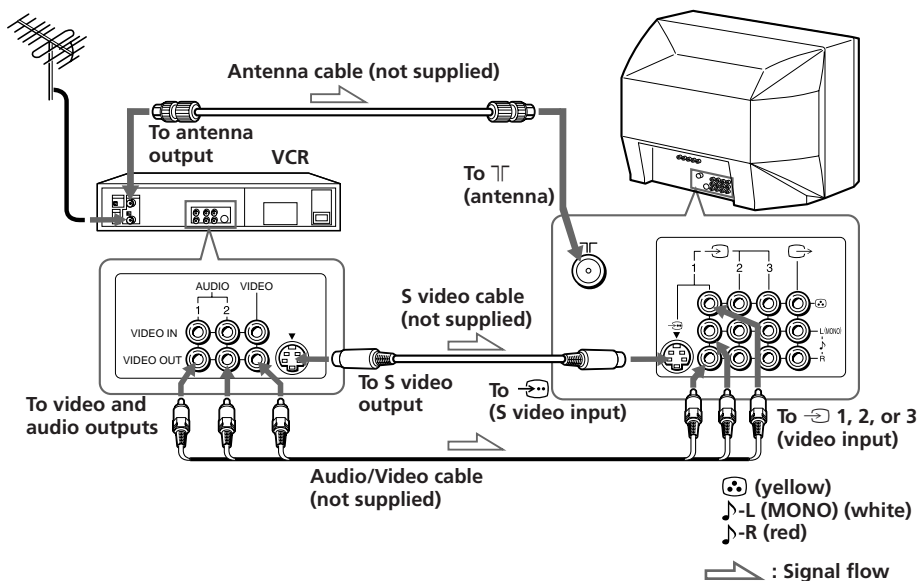

If you wish to connect a VCR, see the "Connecting a VCR" diagram below.



Connecting a VCR



Notes

- If you connect a monaural VCR, connect the yellow plug to  (the yellow jack) and the black plug to -L (MONO) (the white jack).
- If you connect a VCR to the  (antenna) terminal, preset the signal output from the VCR to the program position 0 on the TV.
- Do not simultaneously connect video equipment to the  3 (video input) jacks at the front and the  3 (video input) jacks at the rear of your TV.
- If both  (S video input) and  1 (video input) are input simultaneously, the  (S video input) is automatically selected. To view the video input to  1 (video input), disconnect the S video cable.
- When no signal is input to the connected VCR (or video equipment), the screen becomes blue.

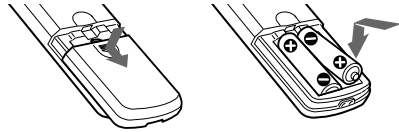
Step 2**Insert the batteries into the remote****Note**

- Do not use old batteries nor use different types of batteries together.

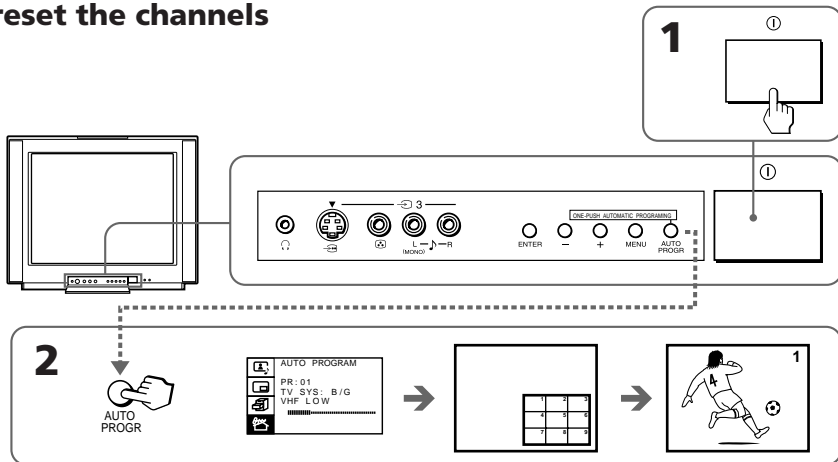
Step 3**Preset the channels****Now You Are Ready . . .**

The channels are now automatically preset in your TV. To preset the channels manually, see page 34.

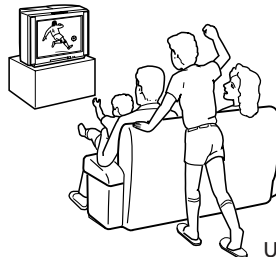



Connecting optional components

You can connect optional audio/video components, such as a VCR, multi disc player, camcorder, video game or stereo system.

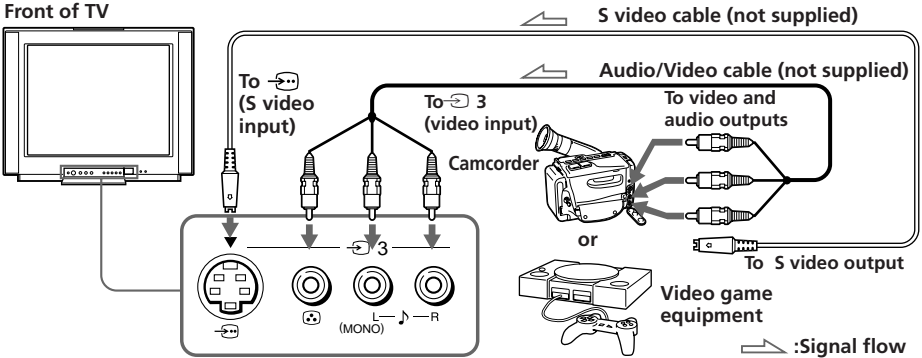
Connecting a camcorder/video game equipment using the (video input) jacks





Notes

- You can also connect video equipment to the  3 (video input) jacks at the rear of your TV.
- Do not simultaneously connect video equipment to the  3 (video input) jacks at the front and the  3 (video input) jacks at the rear of your TV; otherwise, the picture will not be displayed properly on the screen.

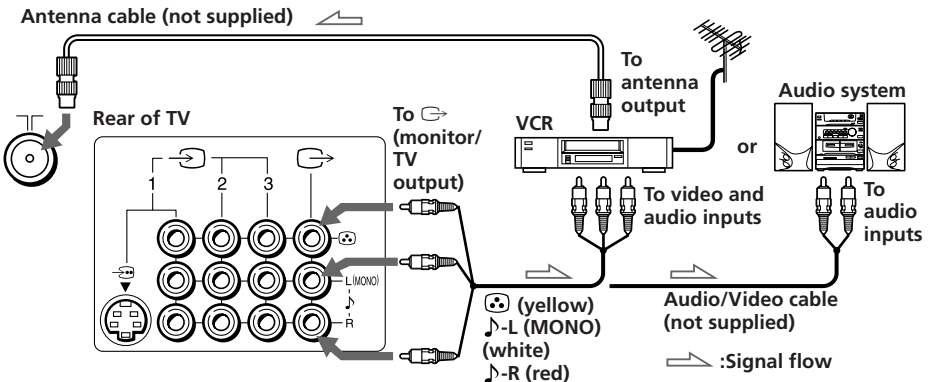
Connecting audio/video equipment using the (monitor/TV output) jacks



Note



- When connecting a monaural VCR, connect the yellow plug to  (the yellow jack) and the black plug to  -L (MONO) (the white jack).

Connecting a DVD player

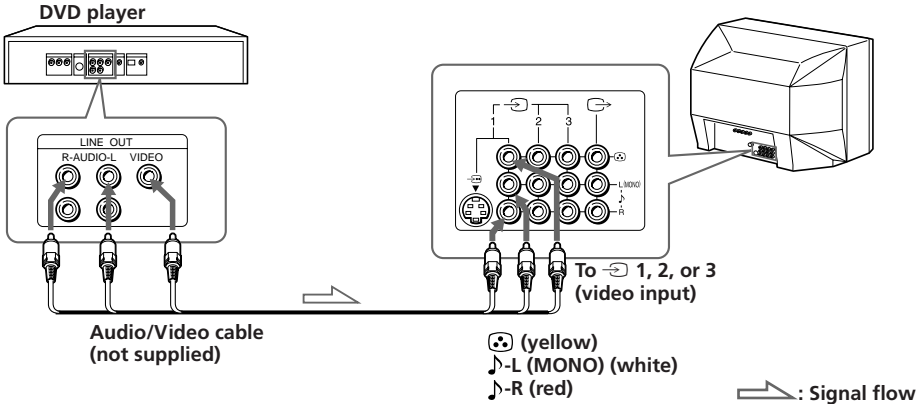
Using /  (audio/video) connectors, connect  1 (video input) on your TV to LINE OUT on your DVD player.



Connecting a DVD player with component video output connectors

- 1 Using audio connectors, connect L and R of  (component video input) on your TV to the AUDIO L and R output connectors on your DVD player.
- 2 Using three yellow video cables, connect Y, B-Y, and R-Y of  (component video input) on your TV to Y, B-Y, and R-Y output on your DVD player.

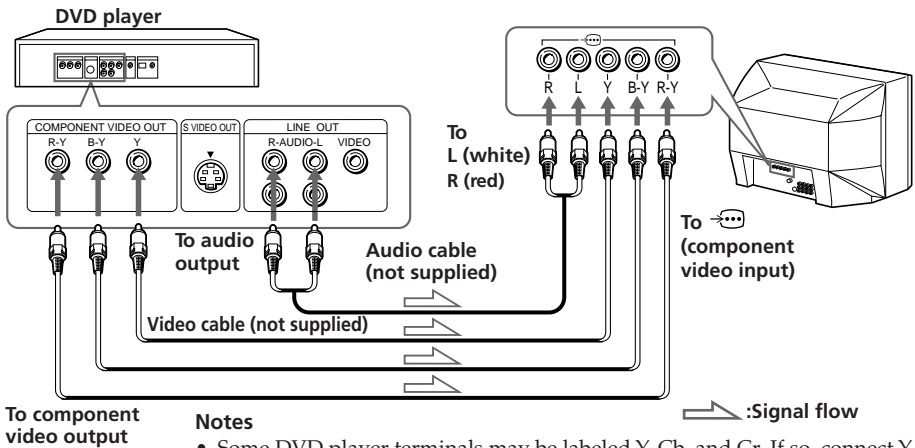

Securing the TV

To prevent the TV from falling, secure the TV using one of the following methods:

- A** With the supplied screws, attach the band to the TV stand and to the rear of the TV using the provided hole.
- B** Put the cord or chain through the clamps to secure the TV against a wall or pillar.

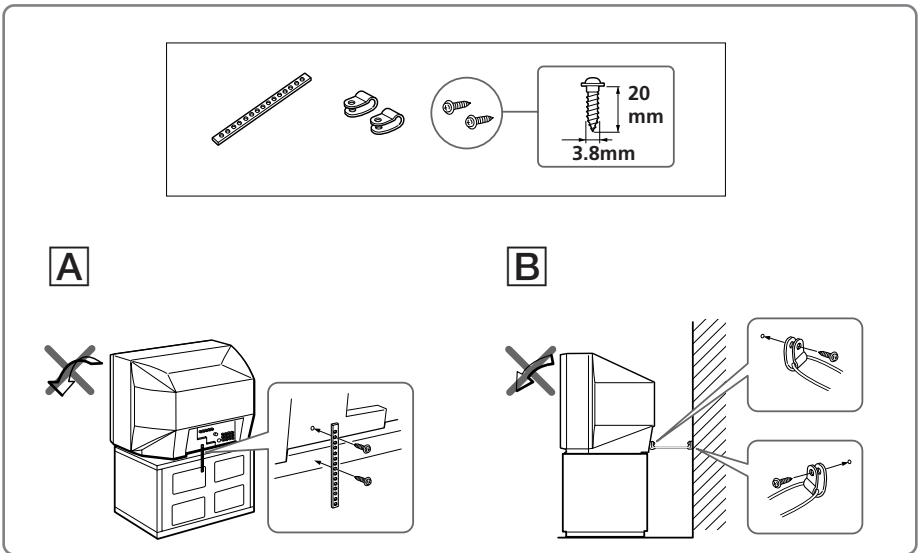

Note

- Use only the supplied screws. Use of other screws may damage the TV.

Watching the TV

This section explains functions used while watching TV. Most operations can be done using the remote.

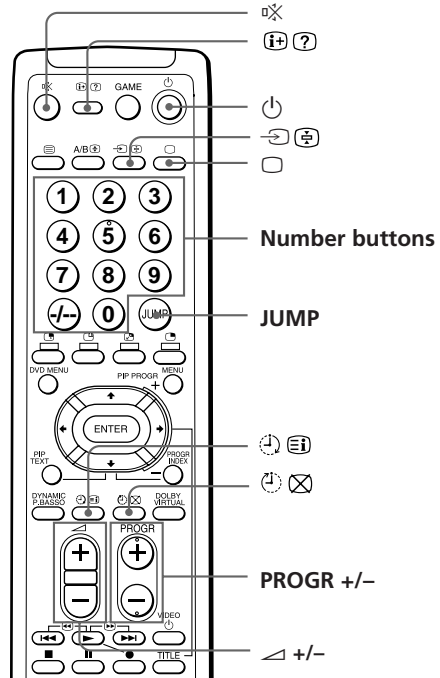
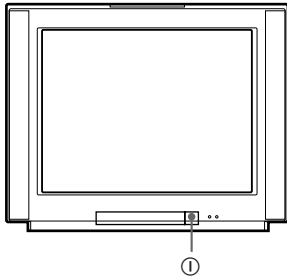

1 Press ① to turn on the TV.

When the TV is in the standby mode (the indicator on the TV is lit), press on the remote or on the TV.

The PROGR +/-, , and indicators on the TV light up.

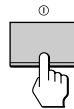

2 Press PROGR +/- or number buttons to select the TV program.



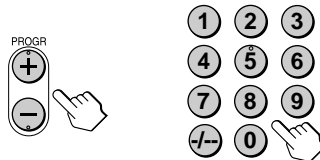







For double digit numbers, press , then the number (e.g., for 25, press , then 2 and 5).



continued

Watching the TV (continued)

Additional tasks

To	Do this
Turn off temporarily	Press  . The  indicator on the TV lights up.
Turn off completely	Press  on the TV.
Adjust the volume	Press  +/-.
Mute the sound	Press  .
Watch the video input	Press  (or  on the TV) to select "VIDEO 1," "VIDEO 2," "VIDEO 3" or "DVD." To go back to the TV program, press  (or  on the TV.)
Jump back to the previous channel	Press JUMP.
Display the on-screen information*	Press   .
Change the on-screen language	See page 27.

* The picture, sound, and either the program position or video mode are displayed. The on-screen display for the picture and sound information disappears after about 3 seconds.

Notes

- When you turn on the TV, you may hear a "boon" sound that is caused by the demagnetization of the TV. This does not indicate a malfunction.
- The picture color may become abnormal if you change the direction of your TV. To obtain the normal picture color, press  on the TV to turn off the TV for five minutes and then turn it on again.

To set the Wake Up timer

- 1 Press until the desired period of time appears.
Every time you press this button, the period of time changes as follows:

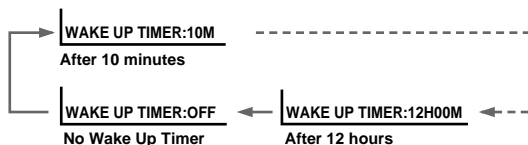

- 2 Select the TV program or video mode you want to display when you wake up.
- 3 Press or set the Sleep timer if you want the TV to turn off automatically.
To cancel the Wake Up timer, press until "WAKE UP TIMER: OFF" appears or turn off the TV's main power.

Notes

- The Wake Up timer starts immediately after the on-screen display disappears.
- If no buttons or controls are pressed for more than two hours after the TV is turned on using the Wake Up timer, the TV automatically goes into the standby mode. To continue watching the TV, press any button or control on the TV or the remote.

To set the Sleep timer

Press until the desired period of time appears.

Every time you press this button, the period of time changes as follows:

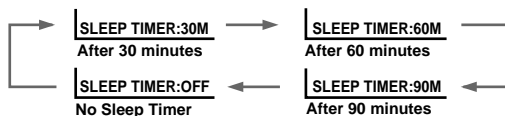

To cancel the Sleep timer, press until "SLEEP TIMER: OFF" appears or turn the TV off.

Listening with dynamic sound

—DYNAMIC POWER BASSO

The DYNAMIC POWER BASSO sound mode enables you to enjoy high quality audio with the best combination of all types of sound. It reproduces dynamic and clear sounds and emphasizes low and high audio effects as well.

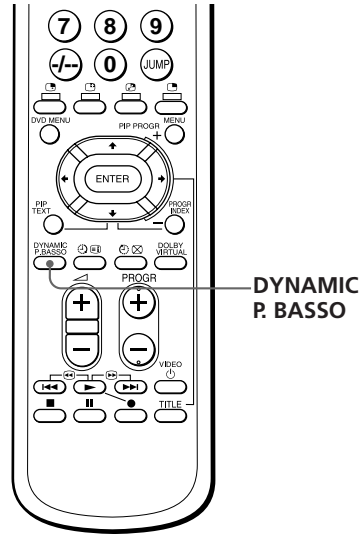

Press DYNAMIC P. BASSO.

The sound mode of the TV program or the video input changes to the DYNAMIC POWER BASSO sound.

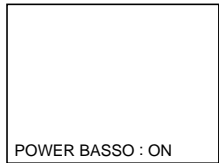

To go back to the normal sound mode

Press DYNAMIC P. BASSO again.

Tip

- Select any of the sound modes (“HYPER SURROUND” or “A/V CONTROL”–“DYNAMIC/STANDARD/SOFT/PERSONAL”) to cancel the DYNAMIC POWER BASSO sound.

Listening with Virtual Dolby* Surround sound

The Virtual Dolby Surround sound mode enables you to enjoy Dolby ProLogic Surround without surround speakers.

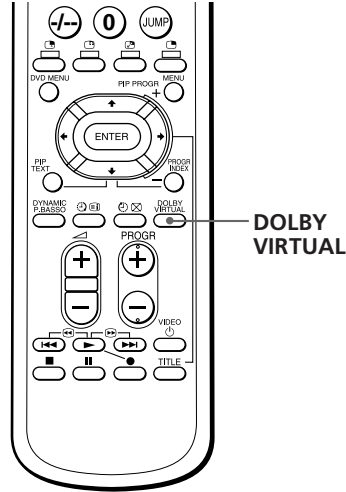

Press DOLBY VIRTUAL.

The sound mode of the TV program or the video input changes to the Virtual Dolby Surround sound.



DOLBY VIRTUAL : ON

To go back to the normal sound mode

Press DOLBY VIRTUAL again.

* Manufactured under license from Dolby Laboratories Licensing Corporation.
DOLBY, the double-D symbol  and "PRO LOGIC" are trademarks of Dolby Laboratories Licensing Corporation.

The Virtual Dolby Surround of this model consists of Dolby Pro Logic and TruSurround.

"**TruSurround**" is a trademark of SRS Labs, Inc. SRS and the SRS symbol are registered trademarks of SRS Labs, Inc. in the United States and selected foreign countries. SRS and TruSurround are incorporated under license from SRS Labs, Inc."

Watching two programs at the same time

—PIP

With the Picture-in-Picture (PIP) feature, you can display a sub screen within the main picture of different TV programs or video inputs.

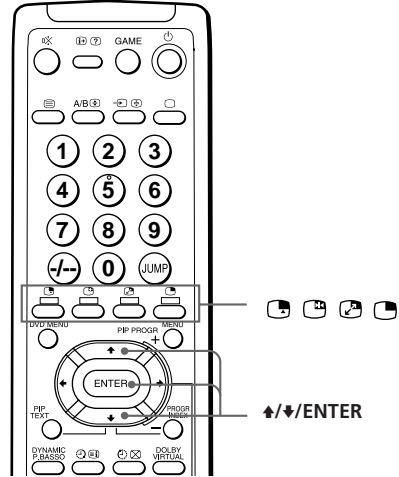

Displaying the PIP screen

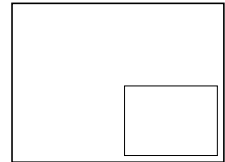
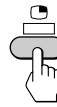

Press .



To select a TV program in the PIP screen

Press  or , and press ENTER.

To select a video input in the PIP screen

Press  (or  on the TV).



To go back to the normal screen

Press .

Tips

- You can also display the PIP screen using the menu (see “Adjusting the PIP setting” on page 30).
- You can change the position of the PIP screen (see “Adjusting the PIP setting” on page 30).

Additional PIP tasks

To	Press
swap pictures between the main and PIP screens	 
freeze the PIP screen	 To unfreeze the screen, press the button again.

Notes

- When you display a video input on the PIP screen at a faster/slower speed, the picture may be disrupted depending on the VCR type.
- If you display different color systems on the main screen and the PIP screen, the size of the PIP screen may be different and the PIP picture may be disrupted. This does not indicate a malfunction of the TV.

Viewing multiple programs at the same time

—PROGRAM INDEX

The PROGRAM INDEX feature allows you to view all of the preset TV programs and the video inputs on the nine sub screens at the same time.

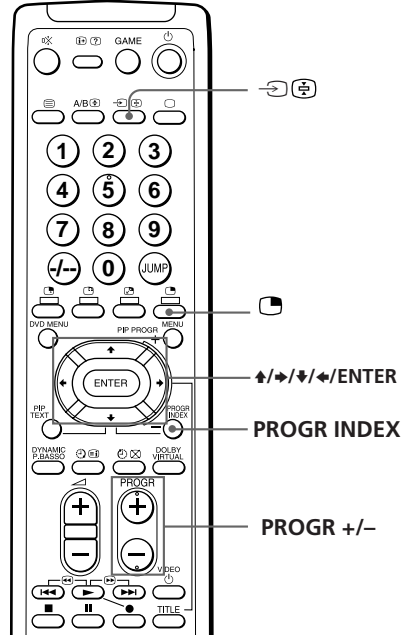

Press PROGR INDEX.

The first nine preset programs appear on the nine sub screens.



>>> 1	2	3
4	5	6
7	8	9

To view the next or the previous nine preset programs

Press PROGR +/- on the remote or the TV.

>>> 1	2	3
4	5	6
7	8	9







>>> 10	11	12
V1	V2	V3
DVD	1	2

To select the desired program directly from the nine sub screens

Press the number buttons or .

You can also select the program you want to watch from the nine sub screens as follows:

- 1 Press /// to move the cursor (>>>) to the screen of the program you want to watch.
- 2 Press ENTER.

To go back to the normal screen

Press PROGR INDEX again or .

You can also go back to the normal screen as follows:

- 1 Select "PROGR INDEX" or "PIP : OFF" from the PIP menu.
- 2 Press ENTER.

Tips

- You can also view multiple programs on the nine sub screens using the menu (see "Adjusting the PIP setting" on page 30).
- You can change the position of the nine sub screens using the PIP menu (see "Adjusting the PIP setting" on page 30).

Notes

- You can use only the number buttons on the remote to change the program position of the main screen when you display the nine sub screens.
- You can only hear the sound of the main screen when viewing multiple programs on the nine sub screens.

Selecting a stereo or bilingual program

(KV-EF29M61/EF29M91/EF29M90 only)

You can enjoy stereo sound or bilingual programs of NICAM and A2 (German) stereo systems.

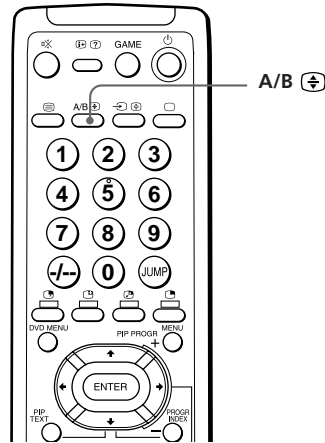

Press A/B repeatedly until you receive the sound you want.

The on-screen display changes to show the selected sound and the / indicator lights up.



When receiving a NICAM program

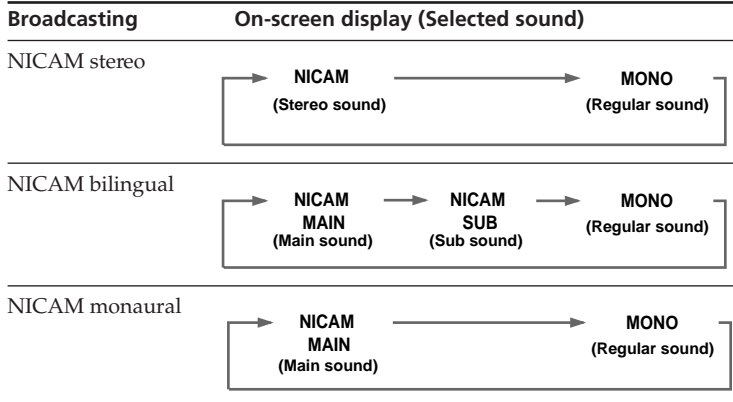

When receiving an A2 (German) program

Broadcasting	On-screen display (Selected sound)
A2 (German) stereo	<p>MONO (Regular sound) → STEREO (Stereo sound)</p>
A2 (German) bilingual	<p>MAIN (Main sound) → SUB (Sub sound)</p>

Receiving area for NICAM and A2 (German) programs

System	Receiving area
NICAM	Hong Kong, Singapore, New Zealand, Malaysia, Thailand, etc.
A2 (German)	Australia, Malaysia, Thailand, etc.

Notes

- If the signal is very weak, the sound becomes monaural automatically.
- If the stereo sound is noisy when receiving a NICAM program, select "MONO". The sound becomes monaural, but the noise is reduced.

If the sound is distorted or noisy when receiving a monaural program through the ㄗ (antenna) terminal

Press A/B repeatedly until "MONO" appears on the screen while the /∞/ indicator is off.

To cancel the monaural sound setting, press A/B again until "AUTO" appears on the screen.



Notes

- The "MONO" or "AUTO" setting is memorized for each program position.
- You cannot receive stereo broadcast signal when the TV is in the "MONO" setting. Normally set the TV to "AUTO."

Viewing Teletext

(KV-EF29M61/EF29M91 only)

TV stations broadcast an information service called Teletext via some TV channels. Teletext allows you to receive various information, such as weather forecasts or news.

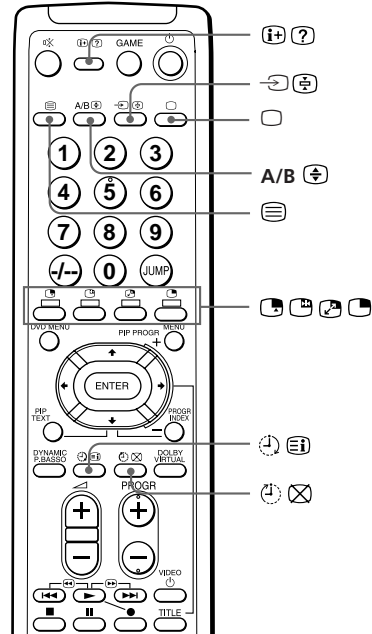

Displaying Teletext

1 Select a TV channel that carries the Teletext broadcast you want to watch.

2 Press to display the text.

A Teletext page (normally the index page) is displayed. If there is no Teletext broadcast, "100" is displayed at the top left corner of the screen.

















P166 SECTEXT 166 FR 1 MAR 03:50:09				
TRAVEL				
From Singapore				
	Day	Dep/Arr	Flight	Aircraft
To PARIS	1,9	2200/0658	SG205	747
	2	2130/1225	FA115	L15
	3	2115/1330	SG206	747
To OSAKA				
	2,5	1000/1715	SG6	747
	4,6	0930/0915	CG522	L10
To ROMA				
	2,7	2130/0745	SG24	747
	4	2300/0915	A2457	747
To SYDNEY				
	1	2210/0810	SG21A	747
	2	2100/0838	SG21A	747

To turn off Teletext





Press .

Additional Teletext tasks

To	Do this
display a Teletext page on the TV picture	Press  . Each time you press  , the screen changes as follows: Teletext → Teletext and TV → TV.
check the contents of a Teletext service	Press   . An overview of the Teletext contents and page numbers appear on the screen.
select a Teletext page	Press the number buttons to enter the three-digit page number of the desired Teletext page.* If you make a mistake, reenter the correct page number. To access the next or previous page, press PROGR +/-.
hold a Teletext page (stop the page from scrolling)	Press   to display the symbol " 
reveal concealed information (e.g., an answer to a quiz)	Press   . To conceal the information, press the button again.
enlarge the Teletext display	Press A/B  . Each time you press A/B  , the Teletext display changes as follows: Enlarge upper half → Enlarge lower half → Normal size.
wait for a Teletext page while watching a TV program	1 Enter the Teletext page number that you want to refer to, then press   . 2 When the page number is displayed, press  to show the text.

* You can also select a Teletext page of any page number that appears in the colored column at the bottom of the screen using the corresponding color-coded button on the remote.

Using FASTEXT

This feature allows you to quickly access a Teletext page that uses FASTEXT. When a FASTEXT program is broadcasted, the colored menus appear at the bottom of the screen. The colors of the menus correspond to the red () , green () , yellow () , and blue () color-coded buttons on the remote.

To access a FASTEXT menu

Press the color-coded button on the remote corresponding to the menu you want. The menu page appears on the screen after several seconds.

Displaying Teletext on the PIP screen

—PIP TEXT

(KV-EF29M61/EF29M91 only)

The PIP TEXT feature enables you to display a Teletext page on the PIP screen while watching a TV program.

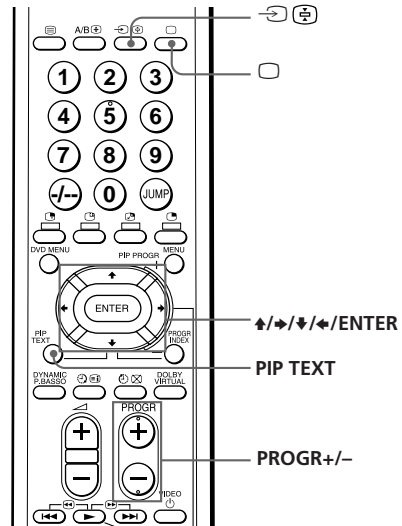



1 Select a TV channel that carries the Teletext broadcast you want to watch.

2 Press PIP TEXT.



To go back to the normal screen









Press PIP TEXT again, or press , , or PROGR +/-.

You can also select "PIP : OFF" from the PIP menu, and press ENTER to go back to the normal screen.

Tips

- You can also display Teletext on the PIP screen using the menu (refer to "Adjusting the PIP setting" on page 30).
- You can also use the color-coded buttons (see page 21) to select pages in the PIP TEXT screen.
- You can change the position of a Teletext page on the PIP screen using the PIP menu (refer to "Adjusting the PIP setting" on page 30).

Note

- To select a Teletext page on the PIP screen, press /// once only. If you press /// continuously, the Teletext page numbers also change continuously at a fast speed.

Viewing a video game screen

—GAME MODE

The GAME MODE feature optimizes the video game screen by giving a soft picture and dynamic sound effects.

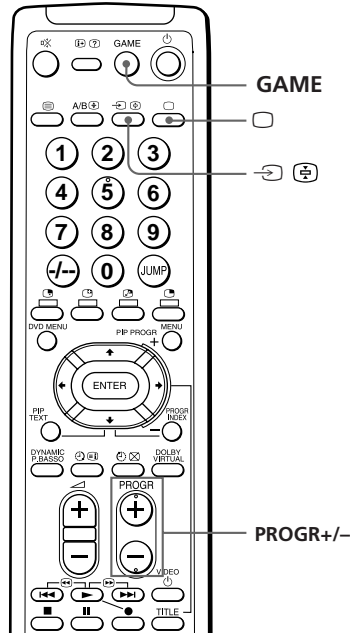

Press GAME.

The picture and sound change to the mode that is suitable for video games.

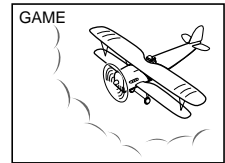

To go back to the normal picture and sound modes

Press \square , \rightarrow $\left[\text{ENTER} \right]$, or PROGR +/-.

Tips

- You can also view the video game screen using the menu (see “Adjusting the FEATURES setting” on page 32).
- You can turn on the TV automatically and enter the GAME mode just by pressing the GAME button when the TV is in the standby mode.

Note

- To display a video game screen, connect the video game equipment to the \rightarrow 3 (video input) jacks at the front or rear of the TV.

Operating optional components

You can use the supplied remote to operate Sony video equipment such as Beta, 8mm, VHS, MDP, CD or DVD.

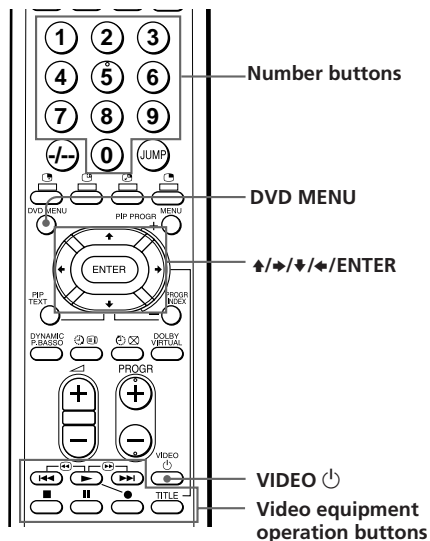

Setting the remote to the connected equipment

While holding down VIDEO , press the following number combinations to enter the equipment's code number (see the chart below).

For example, to operate a Sony 8 mm VCR:

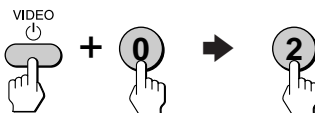











Sony video equipment's code numbers

To control	Hold down VIDEO  and press
DVD	00
VTR1 (Beta)	01
VTR2 (8mm)	02
VTR3 (VHS)	03
MDP	04
CD	06
MD	07











Notes

- If your video equipment is furnished with a COMMAND MODE selector, set this selector to the same position as the setting code.
- If the equipment does not have a certain function, the corresponding button on the remote will not operate.
- When you remove the batteries, the code number may revert to the factory setting.







Operating a VCR using the remote

To	Press
turn on/off	VIDEO 
record	 while pressing 
play	
stop	
fast forward	
rewind the tape	
pause	 Press again to resume normal playback.
search the picture forward or backward	 or  during playback. Release to resume normal playback.

Operating a DVD player using the remote

To	Press
turn on/off	VIDEO 
play	
stop	
pause	 Press again to resume normal playback.
step through different tracks of an audio disc	 to step forward or  to step backward
display the Title menu	TITLE
display the menu	DVD MENU
select the menu item	 /  /  /  while holding down 

Operating an MDP using the remote

To	Press
turn on/off	VIDEO 
play	
stop	
pause	 Press again to resume normal playback.
search the picture forward or backward	 or  during playback. Release to resume normal playback

Introducing the menu system

The MENU button lets you open a menu and change the settings of your TV. Here's an overview of the menu system.

A/V CONTROL

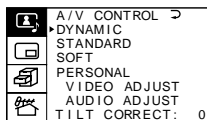

PIP

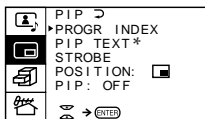

FEATURES

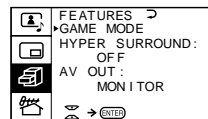

PRESET

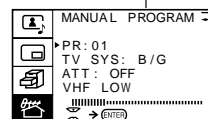
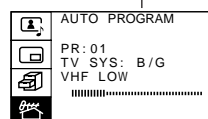
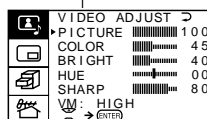

*KV-EF29M61/EF29M91 only

How to use the menu

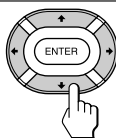
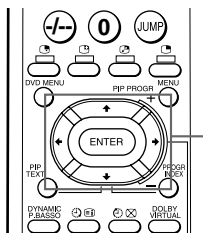

1 After pressing MENU, press $\uparrow/\downarrow/\leftarrow/\rightarrow$ to move the cursor (\blacktriangleright) in four directions to select an item.

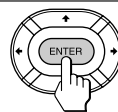

2 Press ENTER to confirm the selection.

To	Do this
go back to the previous menu	Press \uparrow or \downarrow to move the cursor (\blacktriangleright) to the first line (\curvearrowright) of each menu, then press ENTER.*
cancel the menu	Press MENU.
change the menu language	See next page.

* Except for "AUTO PROGRAM"

Notes (except for AUTO PROGRAM)

- When you select a menu, the color of the menu and the menu symbol change and the cursor (\blacktriangleright) appears beside the first item of the menu.
- When an item on the menu is selected after pressing ENTER, the color of the item changes.
- If more than 60 seconds elapse between entries, the menu screen disappears.
- Some menu displays contain the symbol $\text{ENTER} \rightarrow$ ENTER at the bottom of the screen to indicate how to use the menu.

Changing the menu language

You can change the menu language as well as the on-screen language.

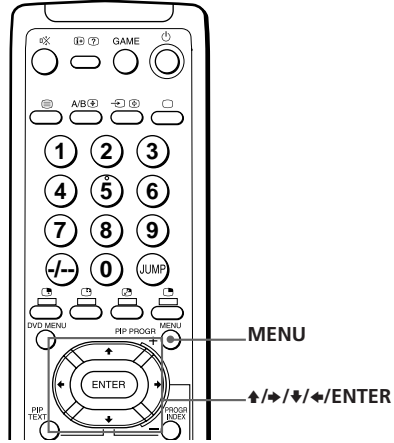

1 Press MENU.

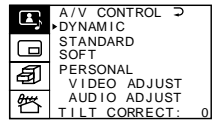

2 Press ↑ or ↓ to move the cursor (▶) to the PRESET menu (), then press ENTER.

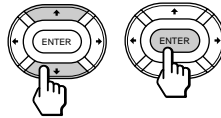

3 Make sure the cursor (▶) appears beside LANGUAGE/语言, then press ENTER.



4 Press ↑/→/↓/← to select 中文, then press ENTER.
The menu language changes to Chinese.

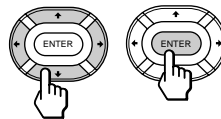

To go back to the normal screen

Press MENU.

Adjusting the A/V CONTROL setting

The A/V CONTROL menu allows you to adjust the picture and sound settings.

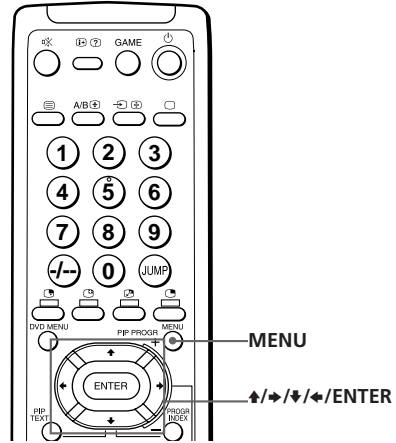

1 Press MENU.

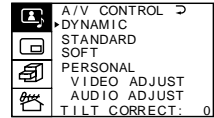

2 Press \uparrow or \downarrow to move the cursor (\blacktriangleright) to \square , then press ENTER.

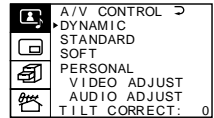
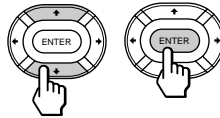

3 Press \uparrow or \downarrow to move the cursor (\blacktriangleright) to the desired option (see the table below), then press ENTER.

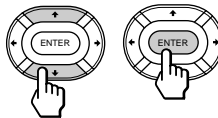

Select	To
DYNAMIC	receive high contrast pictures with powerful sound.
STANDARD	receive normal contrast pictures with medium listening sound.
SOFT	receive mild pictures with soft sound.
PERSONAL VIDEO ADJUST* AUDIO ADJUST*	receive the last picture/sound settings that are adjusted using "VIDEO ADJUST*" and "AUDIO ADJUST*".
TILT CORRECT	adjust the picture tilt when it is not aligned to the TV screen.

* When you select "VIDEO ADJUST" or "AUDIO ADJUST", options for your selection are displayed (see below).

Adjusting the VIDEO ADJUST settings

- 1** Press $\uparrow/\rightarrow/\downarrow/\leftarrow$ to adjust the selected item, then press ENTER.

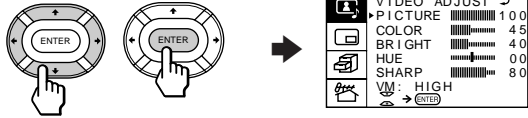

For	Press \downarrow/\leftarrow to	Press \uparrow/\rightarrow to
PICTURE	decrease picture contrast	increase picture contrast
COLOR	decrease color intensity	increase color intensity
BRIGHT	darken the picture	brighten the picture
HUE*	make picture tones reddish	make picture tones greenish
SHARP	soften the picture	sharpen the picture
VM	decrease emphasis on picture edges	increase emphasis on picture edges

* You can adjust HUE for the NTSC color system only.

- 2** Repeat the above step to adjust other items.

Adjusting the AUDIO ADJUST settings

- 1** Press $\uparrow/\rightarrow/\downarrow/\leftarrow$ to adjust the selected item, then press ENTER.

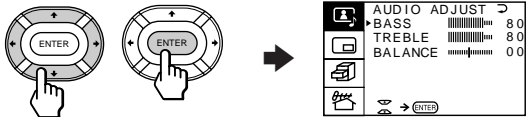

For	Press \downarrow/\leftarrow to	Press \uparrow/\rightarrow to
BASS	decrease the bass	increase the bass
TREBLE	decrease the treble	increase the treble
BALANCE	increase the left speaker's volume	increase the right speaker's volume

- 2** Repeat the above step to adjust other items.

To go back to the normal screen

Press MENU.

Tip

- For details on the menu system and how to use the menu, refer to the "Introducing the menu system" section on page 26.

Adjusting the PIP setting

The PIP menu allows you to use the Picture-in-Picture (PIP) feature.

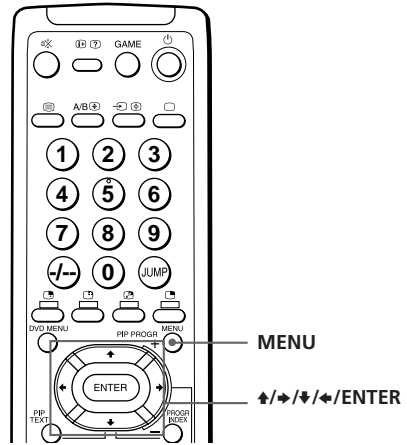

1 Press MENU.





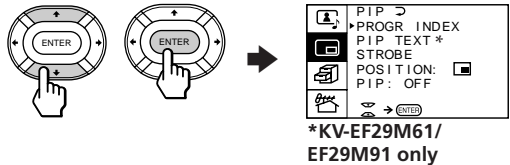

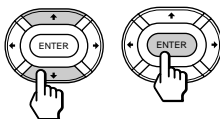

2 Press \uparrow or \downarrow to move the cursor (\blacktriangleright) to (), then press ENTER.



3 Press \uparrow or \downarrow to move the cursor (\blacktriangleright) to the desired option (see the table below), then press ENTER.



Select	To
PROGR INDEX	view multiple programs on the nine sub-screens. To cancel, select "PROGR INDEX" or "PIP: OFF", then press ENTER. Or press PROGR INDEX or  on the remote.
PIP TEXT*	display a Teletext page on the PIP screen. Press $\uparrow/\rightarrow/\downarrow/\leftarrow$ to select the desired Teletext page. To cancel, select "PIP: OFF", then press ENTER. Or press PIP TEXT,  ,  , or PROGR +/- on the remote.
STROBE	view slow motion movement on the nine sub screens. To cancel, select "STROBE" again or "PIP: OFF", then press ENTER. Or press  ,  , or PROGR +/-, or  on the remote.
POSITION	change the position of the PIP screen. Press $\uparrow/\rightarrow/\downarrow/\leftarrow$ to select the desired position, then press ENTER.

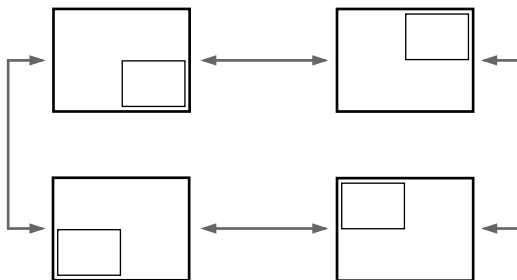

To cancel, press MENU.

PIP	display a sub screen within the main picture. Press $\uparrow/\rightarrow/\downarrow/\leftarrow$ to select "ON", then press ENTER. To cancel, press  or select "OFF", then press ENTER.
-----	--

* KV-EF29M61/EF29M91 only.

Tip

- For details on the menu system and how to use the menu, see the "Introducing the menu system" section on page 26.

Adjusting the FEATURES setting

The FEATURES menu allows you to optimize the screen for video games, enjoy “surround” sound effects, and select the output signal of the TV broadcast or the connected equipment.

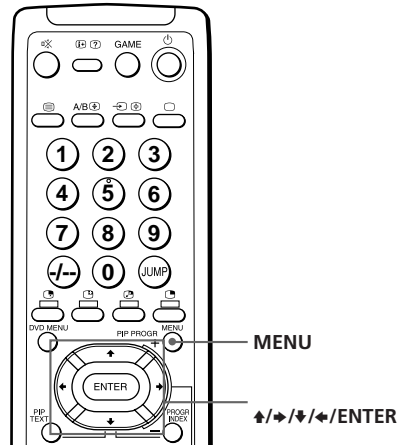

1 Press MENU.

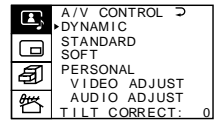

2 Press ↑ or ↓ to move the cursor (▶) to (), then press ENTER.

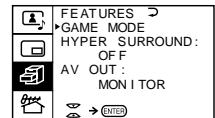
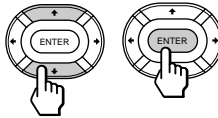

3 Press ↑ or ↓ to move the cursor (▶) to the desired option (see the table below), then press ENTER.

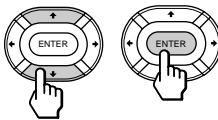

Select	To
GAME MODE	view a video game screen
HYPER SURROUND	enjoy “surround” sound effects of a concert hall or movie theater. Press ↑/→/↓/← to select “DOLBY VIRTUAL”, “MOVIE”, “MUSIC”, “NEWS<BBE ¹ >”, “HALL<SRS ² >”, or “SPACE ³ ” (see below for details on each item).
AV OUT (advanced rec-out)	select the signal output through the G (Monitor/TV output) terminal. Press ↑/→/↓/← to select “TV” (to output the TV broadcast signal) or “MONITOR” (to output the signal of the equipment connected to the TV).

Description of adjustable HYPER SURROUND items

Select	To
DOLBY VIRTUAL	listen to Dolby Surround encoded sound.
MOVIE	listen to sound that emphasizes the bass audio effect of a movie theater.
MUSIC	listen to dynamic and clear sound that emphasizes the low and high sound.
NEWS<BBE ¹⁾ >	listen to sound that emphasizes voice.
HALL<SRS ²⁾ >	listen to sound that spreads out over a large area, giving the feeling of being at a concert hall.
SPACE ³⁾	listen to monaural sound with a stereo-like effect.
OFF	turn off the “surround” sound.

¹⁾ The BBE is manufactured by Sony Corporation under license from BBE Sound, Inc. It is covered by U.S. Patent No. 4,638,258 and No. 4,482,866. The word “BBE” and the BBE symbol are the trademarks of BBE Sound, Inc.

²⁾ The (●) ® SRS (SOUND RETRIEVAL SYSTEM) is manufactured by Sony Corporation under license from SRS Labs, Inc. It is covered by U.S. Patent No. 4,748,669. The word “SRS” and the SRS symbol (●) are registered trademarks of SRS Labs, Inc.

³⁾ SPACE uses SRS MONO.

To go back to the normal screen

Press MENU.

Notes

- Do not change the channel and the input selection while recording with a VCR through the  (Monitor/TV output) jacks. If you change the channel and the input selection, it also changes the channel and input selection that you are recording.
- The signals of the PROGRAM INDEX, STROBE, PIP modes, and the Teletext broadcast cannot be output even though “MONITOR” is selected.

Tip

- For details on the menu system and how to use the menu, see the “Introducing the menu system” section on page 26.

Adjusting the PRESET setting

The PRESET menu allows you to adjust the setup of your TV. For example, you can receive a channel with a weak signal that fails to be tuned in by automatic presetting. In addition, the PRESET menu offers other setup options, such as changing the menu language.

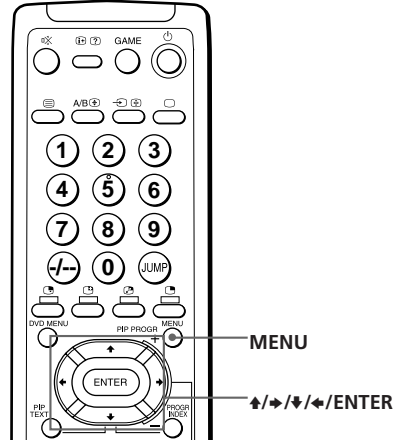

Presetting channels manually

1 Press MENU.

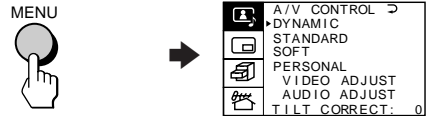

2 Press ↑ or ↓ to move the cursor (▶) to (), then press ENTER.

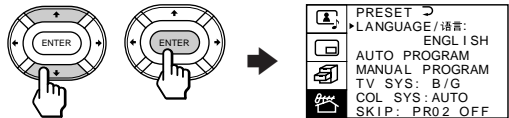

3 Press ↑ or ↓ to move the cursor (▶) to TV SYS, then press ENTER.

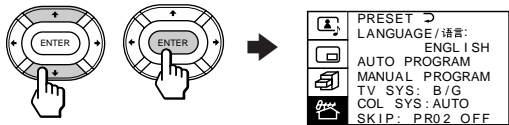

4 Press ↕/↔/↔/↔ until your local TV system appears on the menu, then press ENTER.

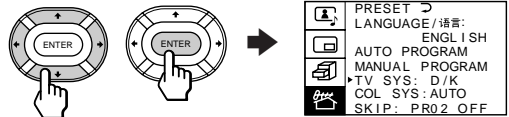

5 Press ↑ or ↓ to move the cursor (▶) to MANUAL PROGRAM, then press ENTER.

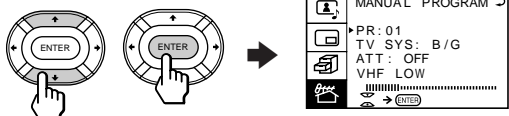

6 Select the program position to which you want to preset a channel.

- (1) Make sure the cursor (▶) appears beside PR, then press ENTER.
- (2) Press ▲/▶/▼/◀ until the program position you want appears on the menu, then press ENTER.

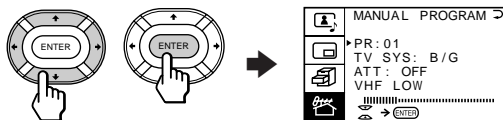

7 Select the desired channel.

- (1) Make sure the cursor (▶) appears beside VHF LOW, then press ENTER.
- (2) Press ▲/▶/▼/◀ until the desired channel picture appears on the TV screen, then press ENTER.

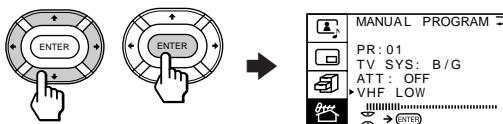

To go back to the normal screen

Press MENU.

Notes

- If the TV signal is too strong and the picture is distorted, select "MANUAL PROGRAM" from the PRESET menu, then select "ATT (attenuator) ON".
- The TV system and the ATT (attenuator) settings are memorized for each program position.
- If you do not know your local TV system, consult your nearest Sony dealer or authorized service center.

continued

Adjusting the PRESET setting (continued)

Changing other PRESET menu options

1 Press MENU.

MENU

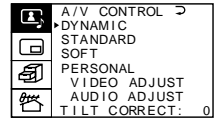

2 Press \uparrow or \downarrow to move the cursor (\blacktriangleright) to (ENTER), then press ENTER.

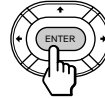
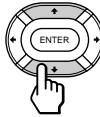

3 Press \uparrow or \downarrow to move the cursor (\blacktriangleright) to the desired option, then press ENTER.

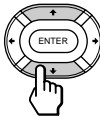

Select	To
LANGUAGE	change the menu language (page 27)
AUTO PROGRAM	preset channels automatically
MANUAL PROGRAM	preset channels manually. See "Presetting channels manually" on page 34.
TV SYS	select the TV system. See "Presetting channels manually" on page 34.
COL SYS	select the color system. Normally, set this to "AUTO".
SKIP	skip unwanted or unused program positions. 1 Press \uparrow / \downarrow until the unused or unwanted program position appears, then press ENTER. 2 Select "ON", then press ENTER. 3 To disable other program positions, repeat steps 1 and 2. To put the skipped program position back on, select "OFF" in step 2.

To go back to the normal screen















Press MENU.

Tip

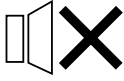
- For details on the menu system and how to use the menu, refer to the "Introducing the menu system" section on page 26.

Troubleshooting

If any problem persists, contact your nearest Sony dealer or authorized service center.

Symptom	Check
<p>Snowy picture</p>  <p>Noisy sound</p> 	<ul style="list-style-type: none"> • Check the antenna and antenna connection on the TV and on the wall. (page 4) • Display the PRESET menu and select the appropriate TV system (TV SYS). (page 34) • Display the PRESET menu and select "MANUAL PROGRAM". Then, select "ATT (attenuator) ON". (page 34)
<p>Good picture</p>  <p>Noisy sound</p> 	<ul style="list-style-type: none"> • Display the PRESET menu and select the appropriate TV system (TV SYS). (page 34)
<p>No picture</p>  <p>No sound</p> 	<ul style="list-style-type: none"> • Press . • Press  on the TV to turn off the TV for about five seconds and then turn it on again. • Check the power cord, antenna, and the VCR connections.
<p>Good picture</p>  <p>No sound</p> 	<ul style="list-style-type: none"> • Press . • Press . • Press A/B  (KV-EF29M61/EF29M91/EF29M90 only).
<p>Dotted lines or stripes</p> 	<ul style="list-style-type: none"> • This may be caused by local interference (e.g. cars, neon signs, hair dryers, etc.). Adjust the antenna direction for minimum interference.
<p>Double images or "ghosts"</p> 	<ul style="list-style-type: none"> • This may be caused by reflections from nearby mountains or buildings. A highly directional antenna may improve the picture.
<p>No color</p> 	<ul style="list-style-type: none"> • Adjust the COLOR level in the VIDEO ADJUST menu of the PERSONAL option. (page 29) • Display the PRESET menu and check the color system (COL SYS) setting. (page 34)

continued

Troubleshooting (continued)

Symptom	Check
TV cabinet creaks.	<ul style="list-style-type: none">• Even if the picture or the sound is normal, changes in room temperature sometimes make the TV cabinet expand or contract, making a noise. This does not indicate a malfunction.
TV cannot receive stereo broadcast signal	<ul style="list-style-type: none">• Press A/B  until "AUTO" appears on the screen. (page 19) (KV-EF29M61/EF29M91/EF29M90 only)

Identifying parts and controls

Refer to the pages indicated in parentheses () for details.

Front panel

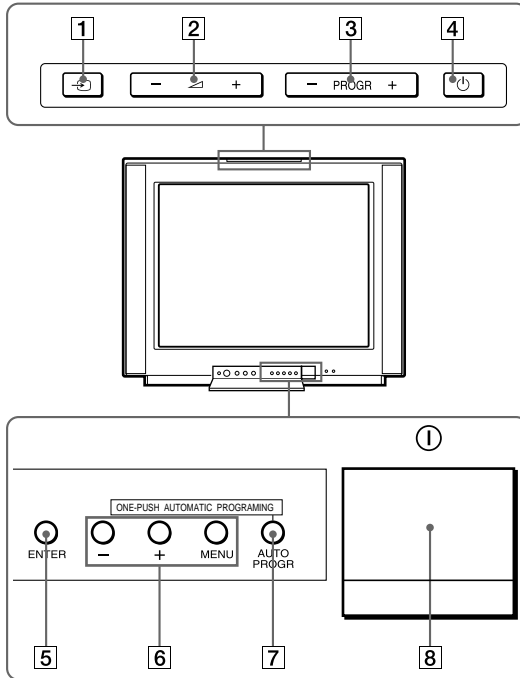

- 1 ↻ (TV/video) button (10)
- 2 ∟ +/- (volume) buttons (10)
- 3 PROGR +/- (program) buttons (9)
- 4 ⏻ (power) button (9)
- 5 ENTER button (26)
- 6 MENU +/- buttons (26)
- 7 AUTO PROGR (program) button (5)
- 8 ① (main power) button (9)

continued

Identifying parts and controls (continued)

Remote

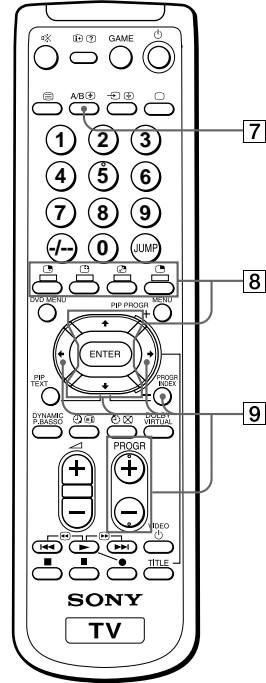
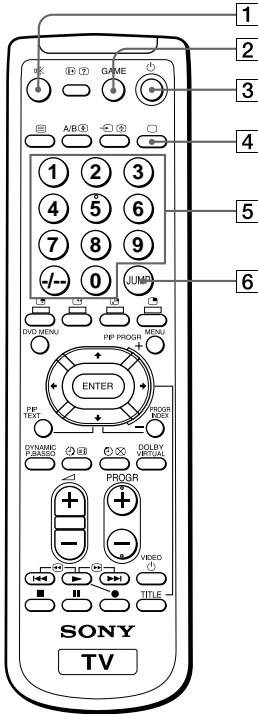

- 1 ✖ (muting) button (10)
- 2 GAME button (23)
- 3 ⏻ (power) button (9)
- 4 □ (TV) button (10)
- 5 Number buttons (9)
- 6 JUMP button (10)

- 7 A/B button (18)
(KV-EF29M61/EF29M91/EF29M90 only)
- 8 PIP operation buttons (14 – 15)
 - 📺 (TV/video)
 - ⏸ (freeze)
 - 🔄 (swap)
 - 📺 (PIP)
 - ⬆/⬇/ENTER—for PIP PROGR

Names/symbols of buttons on the remote are indicated in different colors to represent the available functions.

Label color	Button function
White	For general TV operations
Green	For Teletext operations
Yellow	For PIP and PROGRAM INDEX operations

- 9 PROGRAM INDEX operation buttons (16 – 17)
 - PROGR INDEX
 - ⬆/⬇/⬅/⬅/ENTER
 - PROGR +/-

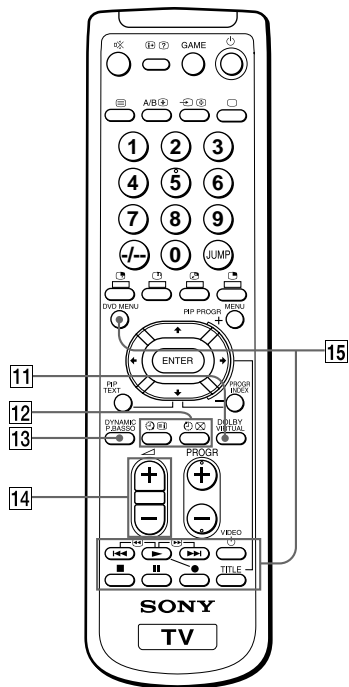
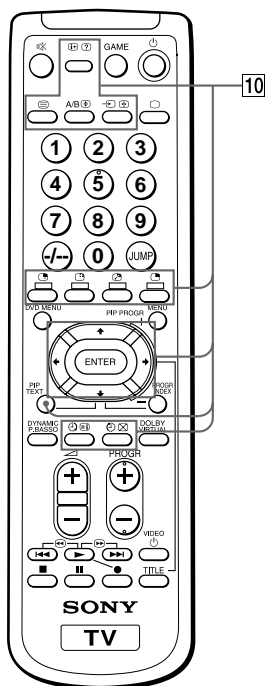

10 Teletext operation buttons (20– 22)
(KV-EF29M61/EF29M91 only)





- (text)
- (enlarge)
- (reveal)
- (hold)
- Red
- Green
- Yellow
- Blue
- (index)
- (text clear)
- PIP TEXT
- /ENTER

11 DOLBY VIRTUAL button (13)
12 Timer setting buttons (11)
⌚ (wake up timer)
⌚ (sleep timer)

13 DYNAMIC P(power). BASSO button (12)
14 (volume) +/- buttons (10)
15 DVD, VCR, MDP, CD, MD operation buttons (25)

- DVD MENU
- (fastforward/search forward)
- (play)
- (rewind/search backward)
- (record)
- (stop)
- (pause)
- VIDEO (power)
- TITLE

Specifications

	KV-EF29M80, KV-EF29M90, KV-EF29M61, KV-EF29M91	Note
Power requirements	110-240 V AC, 50/60 Hz	
Power consumption (W)	Indicated on the rear of the TV	
Television system	B/G, I, D/K, M	
Color system	PAL, PAL 60, SECAM, NTSC4.43, NTSC3.58	
Stereo system	NICAM Stereo B/G, I; A2 Stereo (German) B/G	KV-EF29M61/ EF29M91/ EF29M90
Teletext language	English, Arabic, French	KV-EF29M61/ EF29M91
Channel coverage		
B/G	VHF : E2 to E12 / UHF : E21 to E69 / CATV : S01 to S03, S1 to S41	
I	UHF : B21 to B68 / CATV : S01 to S03, S1 to S41	
D/K	VHF : C1 to C12, R1 to R12 / UHF : C13 to C57, R21 to R60 CATV : S01 to S03, S1 to S41, Z1 to Z39	
M	VHF : A2 to A13 / UHF : A14 to A79/ CATV : A-8 to A-2, A to W+4, W+6 to W+84	
⏏ (Antenna)	75-ohm external terminal	
Audio output (speaker)	15W + 15W	
Number of terminal		
 (video)	Input: 4 Output: 1	phono jacks; 1 Vp-p, 75 ohms
 (Audio)	Input: 4 Output: 1	phono jacks; 500 mVrms
 (S Video)	Input: 2	Y: 1 Vp-p, 75 ohms, unbalanced, sync negative C: 0.286 Vp-p, 75 ohms
 (Component Video)	Input: 1	phono jacks Y: 1.0 Vp-p, 75 ohms, sync negative B-Y: 0.7 Vp-p, 75 ohms R-Y: 0.7 Vp-p, 75 ohms Audio: 500 mVrms,
 (Headphone)	Output: 1	Minijack
Picture tube	29 in.	
Tube size (cm)	72	Measured diagonally
Screen size (cm)	68	Measured diagonally
Dimensions (w/h/d, mm)	716 × 572 × 525	
Mass (kg)	54	

Design and specifications are subject to change without notice.