

SERVICE MANUAL

BA-6 CHASSIS

<u>MODEL NAME</u>	<u>REMOTE COMMANDER</u>	<u>DESTINATION</u>	<u>CHASSIS NO.</u>
KV-27FS320	RM-Y196	US	SCC-S61S-A
KV-27FS320	RM-Y196	CANADA	SCC-S59N-A
KV-32FS120	RM-Y195	US	SCC-S61P-A
KV-32FS120	RM-Y195	CANADA	SCC-S59K-A
KV-32FS320	RM-Y196	US	SCC-S61T-A
KV-32FS320	RM-Y196	CANADA	SCC-S59P-A
KV-34FS120	RM-Y195	LATIN NORTH	SCC-S73F-A
KV-34FS120	RM-Y195	LATIN SOUTH	SCC-S73G-A
KV-36FS120	RM-Y195	US	SCC-S61Q-A
KV-36FS120	RM-Y195	CANADA	SCC-S59L-A
KV-36FS120	RM-Y195	HAWAII	SCC-S74A-A
KV-36FS320	RM-Y196	US	SCC-S61R-A
KV-36FS320	RM-Y196	CANADA	SCC-S59M-A
KV-36FS320	RM-Y196	HAWAII	SCC-S74B-A
KV-38FS120	RM-Y195	LATIN NORTH	SCC-S73G-A



KV-27FS320



KV-32FS120

TRINITRON® COLOR TELEVISION

SONY®

TABLE OF CONTENTS

SECTION TITLE	PAGE	SECTION TITLE	PAGE
Specifications	4	SECTION 5: DIAGRAMS.....	61
Warnings and Cautions	6	5-1. Circuit Boards Location	61
Safety Check-Out	7	5-2. Printed Wiring Board and Schematic Diagram Information..	61
Self-Diagnostic Function.....	8	5.3. Block Diagram and Schematics	62
SECTION 1: DISASSEMBLY.....	10	A Board Schematic Diagram (1 of 2).....	63
1-1. Rear Cover Removal.....	10	A Board Schematic Diagram (2 of 2).....	64
1-2. Chassis Assembly Removal.....	10	HM Board Schematic Diagram (1 of 4)	
1-3. Service Position	11	(KV-27FS320/32FS320/36FS320 Only)	66
1-4. Picture Tube Removal.....	12	HM Board Schematic Diagram (2 of 4)	
Anode Cap Removal Procedure.....	12	(KV-27FS320/32FS320/36FS320 Only)	67
Cable Wire Dressing	13	HM Board Schematic Diagram (3 of 4)	
KV-27FS320/32FS320/36FS320 Models.....	13	(KV-27FS320/32FS320/36FS320 Only)	68
KV-32FS120/34FS120 Models	13	HM Board Schematic Diagram (4 of 4)	
KV-36FS120/38FS120 Models	18	(KV-27FS320/32FS320/36FS320 Only)	68
SECTION 2: SET-UP ADJUSTMENTS.....	23	V Board Schematic Diagram	69
2-1. Beam Landing	23	M Board Schematic Diagram	70
2-2. Convergence.....	24	C Board Schematic Diagram	72
2-3. Focus	25	HN Board Schematic Diagram	
2-4. Screen (G2).....	26	(KV-27FS320/32FS320/36FS320 Only)	73
2-5. Method of Setting the Service Adjustment Mode	26	HR Board Schematic Diagram	
2-6. White Balance Adjustments	26	(KV-27FS320/32FS320/36FS320 Only)	73
SECTION 3: SAFETY RELATED ADJUSTMENTS.....	27	HS Board Schematic Diagram	
3-1. <input checked="" type="checkbox"/> R530, R531 Confirmation Method (HV Hold-Down		(KV-32FS120/34FS120/36FS120/38FS120 Only)...	73
Confirmation) and Readjustments.....	27	HU/HD Board Schematic Diagram	
3-2. B+ Voltage Confirmation and Adjustment	27	(KV-27FS320/32FS320/36FS320 Only)	76
SECTION 4: CIRCUIT ADJUSTMENTS.....	28	5-4. Semiconductors	79
4-1. Setting the Service Adjustment Mode	28	SECTION 6: EXPLODED VIEWS.....	80
4-2. Memory Write Confirmation Method	28	6-1. Chassis	
4-3. Remote Adjustment Buttons and Indicators	28	(KV-27FS320/32FS320/36FS320 Only).....	80
4-4. Service Data Lists	29	6-2. Picture Tube	
KV-27FS320 Service Data	29	(KV-27FS320/32FS320/36FS320 Only).....	81
KV-32FS320 Service Data	30	6-3. Chassis	
KV-36FS320 Service Data	39	(KV-32FS120/34FS120/36FS120/38FS120 Only)	82
KV-32FS120/34FS120 Service Data.....	48	6-4. Picture Tube	
KV-36FS120/38FS120 Service Data.....	57	(KV-32FS120/34FS120/36FS120/38FS120 Only)	83
4-5. ID Map Table	57	SECTION 7: ELECTRICAL PARTS LIST	84
4-6. A Board Adjustments.....	58		

SPECIFICATIONS

	KV-27FS320	KV-32FS120	KV-32FS320	KV-34FS120
Power Requirements	120V, 60Hz	120V, 60Hz	120V, 60Hz	120V-220V, 50/60Hz
Number of Inputs/Outputs				
Video ¹⁾	3	3	3	3
S Video ²⁾	1	1	1	1
Y, P_B, P_R ³⁾	2	1	2	1
Audio ⁴⁾	2	3	2	3
RF	1	1	1	1
Speaker Output (W)	10W x 2	10W x 2	10W x 2	10W x 2
Power Consumption (W)				
In Use (Max)	180W	175W	190W	175W (170W Chile, Peru, Bolivia)
In Standby (Max) ⁵⁾	1W	1W	1W	1W
Dimensions (W x H x D)				
mm	784 x 601.5 x 520 mm	898 x 696 x 576 mm	898 x 682 x 584 mm	898 x 696 x 576 mm
in	30 ^{7/8} x 23 ^{5/8} x 20 ^{1/2} in	35 ^{3/8} x 27 ^{3/8} x 22 ^{5/8} in	35 ^{3/8} x 26 ^{7/8} x 23 in	35 ^{3/8} x 27 ^{3/8} x 22 ^{5/8} in
Mass				
kg	47.4 kg	75 kg	75.80 kg	75 kg
lbs	104 lbs 8 oz	165 lbs 6 oz	167 lbs 2 oz	165 lbs 6 oz

	KV-36FS120	KV-36FS320	KV-38FS120
Power Requirements	120V, 60Hz	120V, 60Hz	120V-220V, 50/60Hz
Number of Inputs/Outputs			
Video ¹⁾	3	3	3
S Video ²⁾	1	1	1
Y, P_B, P_R ³⁾	1	2	1
Audio ⁴⁾	3	2	3
RF	1	1	1
Speaker Output (W)	10W x 2	10W x 2	10W x 2
Power Consumption (W)			
In Use (Max)	180W	190W	180W
In Standby (Max) ⁵⁾	1W	1W	1W
Dimensions (W x H x D)			
mm	985 x 774 x 633 mm	1020 x 760 x 640 mm	985 x 774 x 633 mm
in	38 ^{3/4} x 30 ^{1/2} x 24 ^{7/8} in	40 ^{1/8} x 29 ^{7/8} x 25 ^{1/4} in	38 ^{3/4} x 30 ^{1/2} x 24 ^{7/8} in
Mass			
kg	98.4 kg	101.2 kg	98.4 kg
lbs	216 lbs 15 oz	223 lbs 2 oz	216 lbs 15 oz

- 1) 1 Vp-p 75 ohms unbalanced, sync negative
- 2) Y: 1 Vp-p 75 ohms unbalanced, sync negative
C: 0.286 Vp-p (Burst signal), 75 ohms
- 3) Y: 1.0 Vp-p, 75 ohms, sync negative; PB: 0.7 Vp-p, 75 ohms;
PR Vp-p, 75 ohms.
- 4) 500 mVrms (100% modulation), Impedance: 47 kilohms
- 5) This specification is the maximum wattage.

TruSurround™ by SRS (SRS)®

TruSurround is a trademark of SRS Labs, Inc. SRS and the SRS symbol are registered trademarks of SRS Labs, Inc. in the United States and in select foreign countries. SRS and TruSurround are incorporated under license from SRS Labs, Inc. and are protected under United States Patent Nos. 4,748,669 and 4,841,572 with numerous additional issued and pending foreign patents. Purchase of this product does not convey the right to sell recordings made with the TruSurround technology.

● SRS (SOUND RETRIEVAL SYSTEM)

The ● SRS (SOUND RETRIEVAL SYSTEM) is manufactured by Sony Corporation under license from SRS Labs, Inc. It is covered by U.S. Patent No. 4,748,669. Other U.S. and foreign patents pending.

The word 'SRS' and the SRS symbol ● are registered trademarks of SRS Labs, Inc. BBE and BBE symbol are trademarks of BBE Sound, Inc. and are licensed by BBE Sound, Inc. under U.S. Patent No. 4,638,258 and 4,482,866.

Design and specifications are subject to change without notice.

Television system

American TV standard, NTSC

Channel coverage

VHF: 2-13/ UHF: 14-69/ CATV: 1-125

Antenna

75-ohm external antenna terminal for VHF/UHF

Picture tube

FD Trinitron® tube

Visible screen size

27-inch picture measured diagonally (KV-27FS320 Only)

32-inch picture measured diagonally (KV-32FS120/32FS320/34FS120 Only)

36-inch picture measured diagonally (KV-36FS120/36FS320/38FS120 Only)

Actual screen size

29-inch measured diagonally (KV-27FS320 Only)

34-inch measured diagonally (KV-32FS120/32FS320/34FS120 Only)

38-inch measured diagonally (KV-36FS120/36FS320/38FS120 Only)

Supplied Accessories

Remote Commander RM-Y195 (All Except KV-27FS320/32FS320/36FS320)

Remote Commander RM-Y196(KV-27FS320/32FS320/36FS320 Only)

Two Size AA (R6) Batteries

Optional Accessories

TV Stand

SU-27F2 (KV-27FS320 Only)

SU-32F2 (KV-32FS120/32FS320/34FS120 Only)

SU-36F2 (KV-36FS120/36FS320/38FS120 Only)

WARNINGS AND CAUTIONS

CAUTION

Short circuit the anode of the picture tube and the anode cap to the metal chassis, CRT shield, or carbon painted on the CRT, after removing the anode.

WARNING!!

An isolation transformer should be used during any service to avoid possible shock hazard, because of live chassis. The chassis of this receiver is directly connected to the AC power line.

SAFETY-RELATED COMPONENT WARNING!!

Components identified by shading and  mark on the schematic diagrams, exploded views, and in the parts list are critical for safe operation. Replace these components with Sony parts whose part numbers appear as shown in this manual or in supplements published by Sony. Circuit adjustments that are critical for safe operation are identified in this manual. Follow these procedures whenever critical components are replaced or improper operation is suspected.

ATTENTION!!

Après avoir déconnecté le cap de l'anode, court-circuiter l'anode du tube cathodique et celui de l'anode du cap au châssis métallique de l'appareil, ou la couche de carbone peinte sur le tube cathodique ou au blindage du tube cathodique.

Afin d'éviter tout risque d'électrocution provenant d'un châssis sous tension, un transformateur d'isolement doit être utilisé lors de tout dépannage. Le châssis de ce récepteur est directement raccordé à l'alimentation du secteur.

ATTENTION AUX COMPOSANTS RELATIFS A LA SECURITE!!

Les composants identifiés par une trame et par une marque  sur les schémas de principe, les vues explosées et les listes de pièces sont d'une importance critique pour la sécurité du fonctionnement. Ne les remplacer que par des composants Sony dont le numéro de pièce est indiqué dans le présent manuel ou dans des suppléments publiés par Sony. Les réglages de circuit dont l'importance est critique pour la sécurité du fonctionnement sont identifiés dans le présent manuel. Suivre ces procédures lors de chaque remplacement de composants critiques, ou lorsqu'un mauvais fonctionnement suspecte.

SAFETY CHECK-OUT

After correcting the original service problem, perform the following safety checks before releasing the set to the customer:

1. Check the area of your repair for unsoldered or poorly soldered connections. Check the entire board surface for solder splashes and bridges.
2. Check the interboard wiring to ensure that no wires are "pinched" or touching high-wattage resistors.
3. Check that all control knobs, shields, covers, ground straps, and mounting hardware have been replaced. Be absolutely certain that you have replaced all the insulators.
4. Look for unauthorized replacement parts, particularly transistors, that were installed during a previous repair. Point them out to the customer and recommend their replacement.
5. Look for parts which, though functioning, show obvious signs of deterioration. Point them out to the customer and recommend their replacement.
6. Check the line cords for cracks and abrasion. Recommend the replacement of any such line cord to the customer.
7. Check the B+ and HV to see if they are specified values. Make sure your instruments are accurate; be suspicious of your HV meter if sets always have low HV.
8. Check the antenna terminals, metal trim, "metallized" knobs, screws, and all other exposed metal parts for AC leakage. Check leakage as described below.

Leakage Test

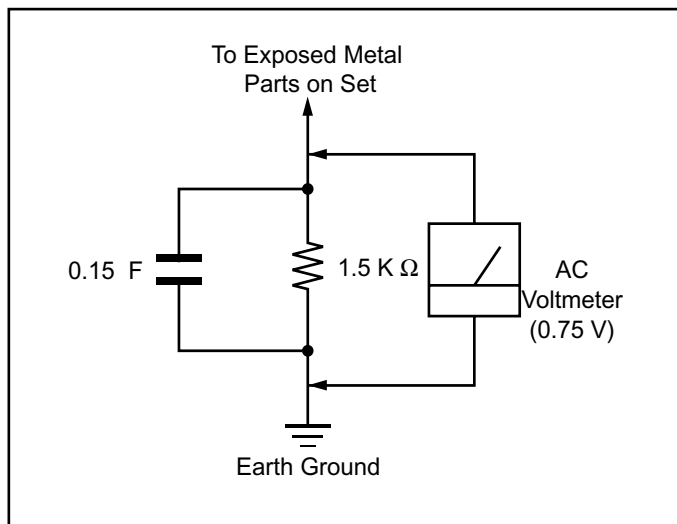

Figure A. Using an AC voltmeter to check AC leakage.

The AC leakage from any exposed metal part to earth ground and from all exposed metal parts to any exposed metal part having a return to chassis, must not exceed 0.5 mA (500 microamperes). Leakage current can be measured by any one of three methods.

1. A commercial leakage tester, such as the Simpson 229 or RCA WT-540A. Follow the manufacturers' instructions to use these instructions.
2. A battery-operated AC milliammeter. The Data Precision 245 digital multimeter is suitable for this job.
3. Measuring the voltage drop across a resistor by means of a VOM or battery-operated AC voltmeter. The "limit" indication is 0.75 V, so analog meters must have an accurate low voltage scale. The Simpson's 250 and Sanwa SH-63TRD are examples of passive VOMs that are suitable. Nearly all battery-operated digital multimeters that have a 2 VAC range are suitable (see Figure A).

How to Find a Good Earth Ground

A cold-water pipe is a guaranteed earth ground; the cover-plate retaining screw on most AC outlet boxes is also at earth ground. If the retaining screw is to be used as your earth ground, verify that it is at ground by measuring the resistance between it and a cold-water pipe with an ohmmeter. The reading should be zero ohms.

If a cold-water pipe is not accessible, connect a 60- to 100-watt trouble- light (not a neon lamp) between the hot side of the receptacle and the retaining screw. Try both slots, if necessary, to locate the hot side on the line; the lamp should light at normal brilliance if the screw is at ground potential (see Figure B).

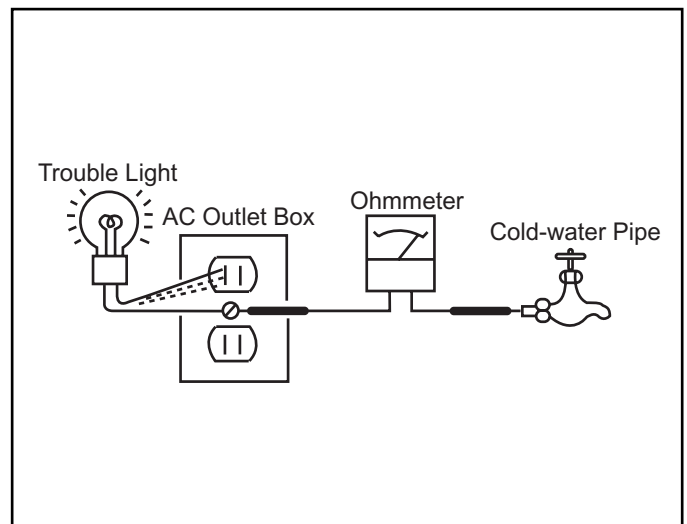

Figure B. Checking for earth ground.

SELF-DIAGNOSTIC FUNCTION



The units in this manual contain a self-diagnostic function. If an error occurs, the STANDBY/TIMER LED will automatically begin to flash. The number of times the LED flashes translates to a probable source of the problem. A definition of the STANDBY/TIMER LED flash indicators is listed in the instruction manual for the user's knowledge and reference. If an error symptom cannot be reproduced, the Remote Commander can be used to review the failure occurrence data stored in memory to reveal past problems and how often these problems occur.

Diagnostic Test Indicators

When an error occurs, the STANDBY/TIMER LED will flash a set number of times to indicate the possible cause of the problem. If there is more than one error, the LED will identify the first of the problem areas.

Results for all of the following diagnostic items are displayed on screen. No error has occurred if the screen displays a "0".

Diagnostic Item Description	No. of times STANDBY/ TIMER lamp flashes	Self-Diagnostic Display/ Diagnostic Result	Probable Cause Location	Detected Symptoms
Power does not turn on	Does not light	—————	<ul style="list-style-type: none"> Power cord is not plugged in. Fuse is burned out (F601). (A Board) 	<ul style="list-style-type: none"> Power does not come on. No power is supplied to the TV. AC Power supply is faulty.
+B overcurrent (OCP)*	2 times	2:0 or 2:1	<ul style="list-style-type: none"> H.OUT (Q502) is shorted. (A Board) IC702 is shorted. (C Board) 	<ul style="list-style-type: none"> Power does not come on. Load on power line is shorted.
I-Prot	4 times	4:0 or 4:1	<ul style="list-style-type: none"> +13V is not supplied. (A Board) IC561 is faulty. (A Board) 	<ul style="list-style-type: none"> Has entered standby state after horizontal raster. Vertical deflection pulse is stopped. Power line is shorted or power supply is stopped.
IK (AKB)	5 times	5:0 or 5:1	<ul style="list-style-type: none"> IC001 is faulty. (M Board) Screen (G2) is improperly adjusted.** 	<ul style="list-style-type: none"> No raster is generated. CRT Cathode current detection reference pulse output is small.

*If a +B overcurrent is detected, stoppage of the vertical deflection is detected simultaneously. The symptom that is diagnosed first by the microcontroller is displayed on the screen.

**Refer to Screen (G2) Adjustments in Section 2-4. of this manual.

Display of Standby/Timer LED Flash Count

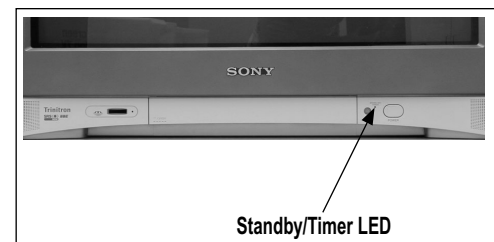
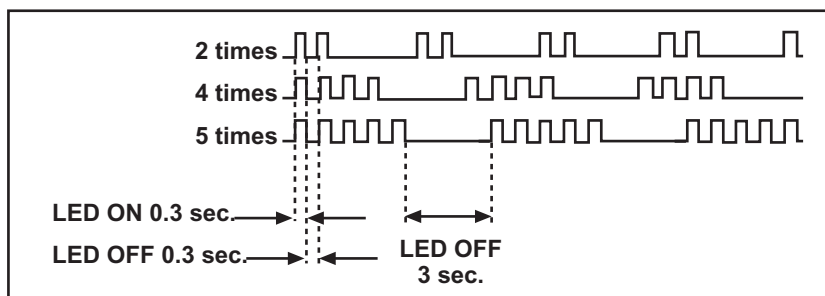

Diagnostic Item	Flash Count*
+B Overcurrent	2 times
I-Prot	4 times
IK (AKB)	5 times

*One flash count is not used for self-diagnostic.

Stopping the Standby/Timer LED Flash

Turn off the power switch on the TV main unit or unplug the power cord from the outlet to stop the STANDBY/TIMER LAMP from flashing.

Self-Diagnostic Screen Display

For errors with symptoms such as “power sometimes shuts off” or “screen sometimes goes out” that cannot be confirmed, it is possible to bring up past occurrences of failure on the screen for confirmation.

To Bring Up Screen Test

In standby mode, press buttons on the Remote Commander sequentially, in rapid succession, as shown below:

Display → Channel → Sound Volume → Power ON

↑ Note that this differs from entering the Service Mode (Sound Volume +).

Self-Diagnostic Screen Display

SELF DIAGNOSTIC		
2:	+B OCP	0
3:	+B OVP	N/A
4:	VSTOP	0
5:	AKB	1
101:	WDT	N/A

Numeral “0” means that no fault was detected.

Numeral “1” means a fault was detected one time only.

Handling of Self-Diagnostic Screen Display

Since the diagnostic results displayed on the screen are not automatically cleared, always check the self-diagnostic screen during repairs. When you have completed the repairs, clear the result display to “0”.

Unless the result display is cleared to “0”, the self-diagnostic function will not be able to detect subsequent faults after completion of the repairs.

Clearing the Result Display

To clear the result display to “0”, press buttons on the Remote Commander sequentially when the diagnostic screen is displayed, as shown below:

Channel → ENTER

Quitting the Self-Diagnostic Screen

To quit the entire self-diagnostic screen, turn off the power switch on the Remote Commander or the main unit.

Self-Diagnostic Circuit

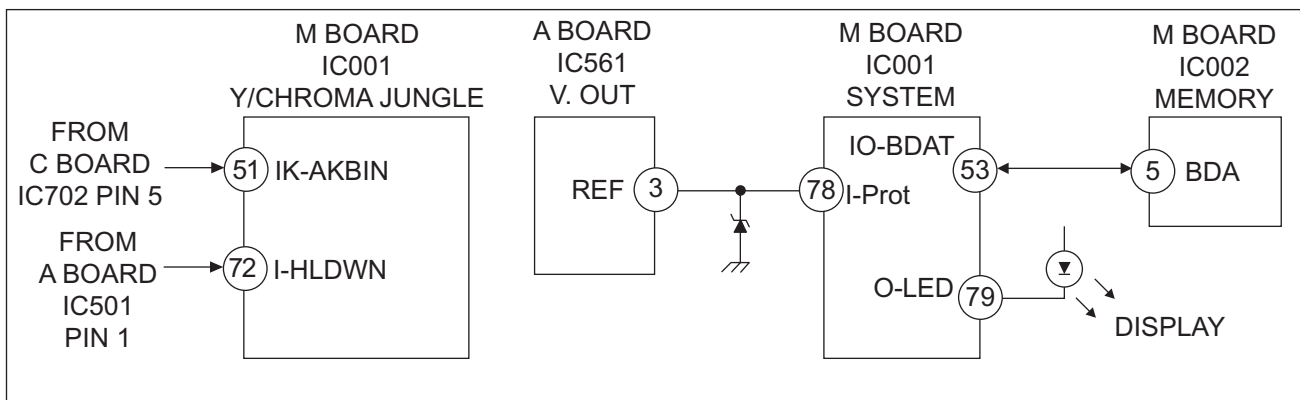

+B overcurrent (OCP)

Occurs when an overcurrent on the +B (135V) line is detected by pin 72 of IC001 (M Board). If the voltage of pin 72 of IC001 (M Board) is less than 1V when V.SYNC is more than seven verticals in a period, the unit will automatically turn off.

I-Prot

Occurs when an absence of the vertical deflection pulse is detected by pin 78 of IC001 (M Board). Power supply will shut down when waveform interval exceeds 2 seconds.

IK (AKB)

If the RGB levels* do not balance within 2 seconds after the power is turned on, this error will be detected by IC001 (M Board). TV will stay on, but there will be no picture.

*(Refers to the RGB levels of the AKB detection Ref pulse that detects 1K).

SECTION 1: DISASSEMBLY

1-1. REAR COVER REMOVAL (KV-27FS320 PICTURED)

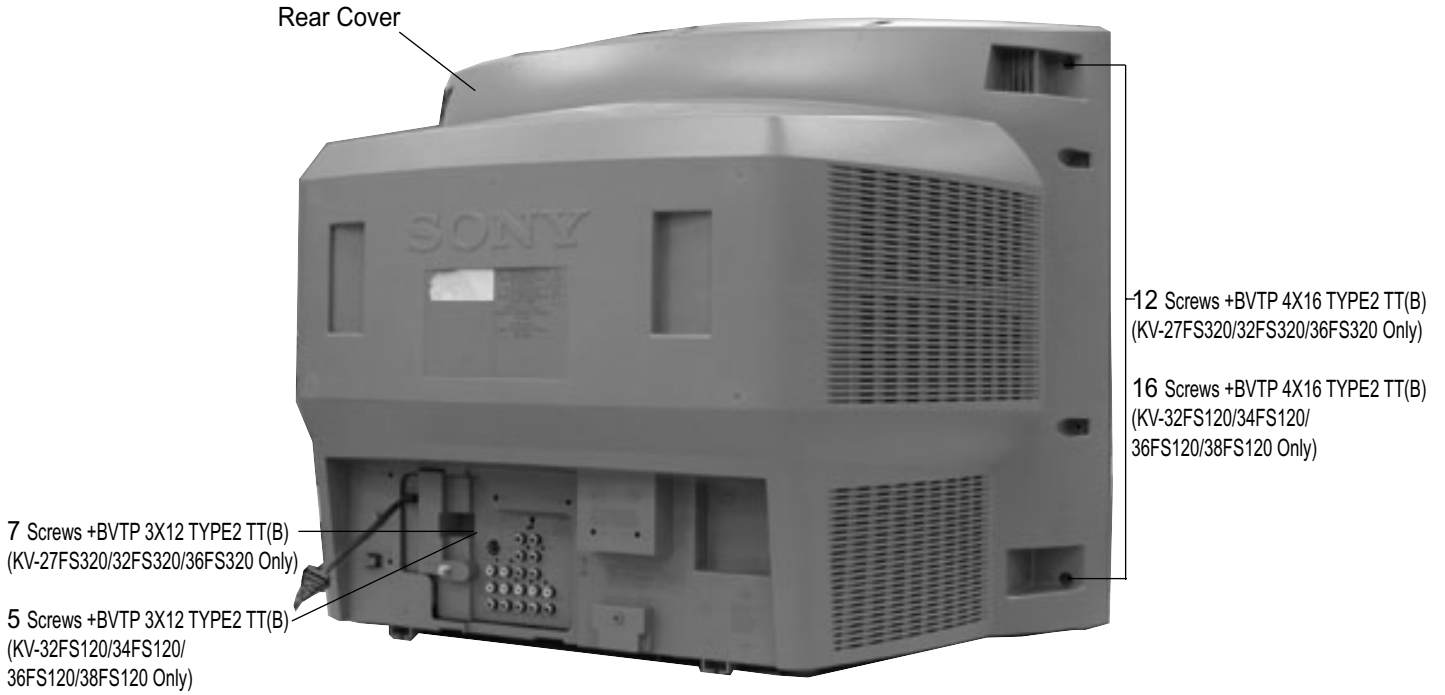

1-2. CHASSIS ASSEMBLY REMOVAL

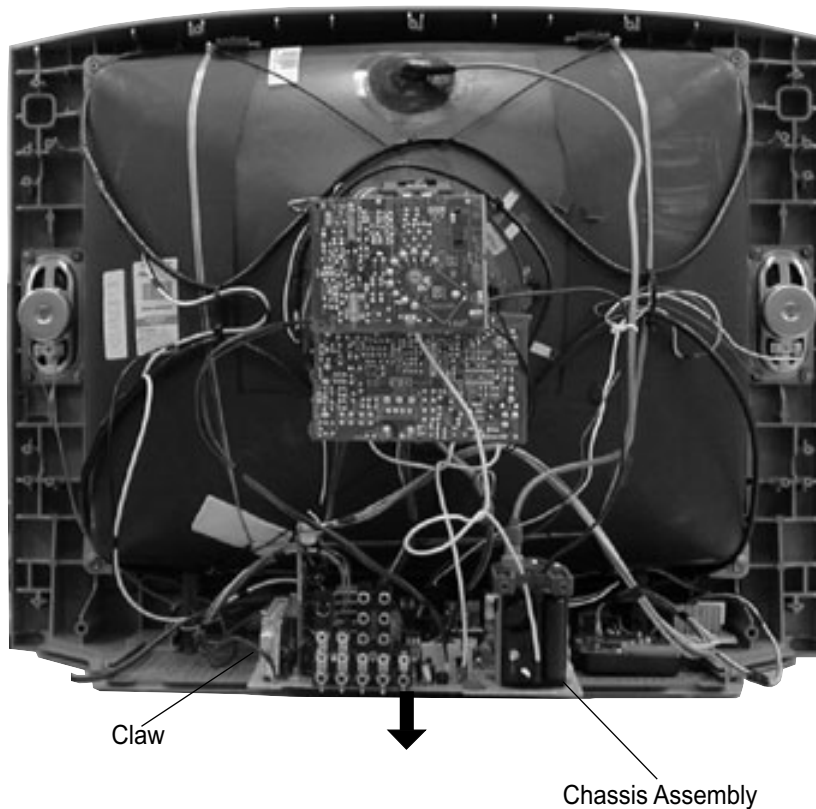

1-3. SERVICE POSITION (KV-27FS320 PICTURED)

- ① Press on catch tab to release A Board.
- ② Disconnect cables as needed to allow A Board to be removed.

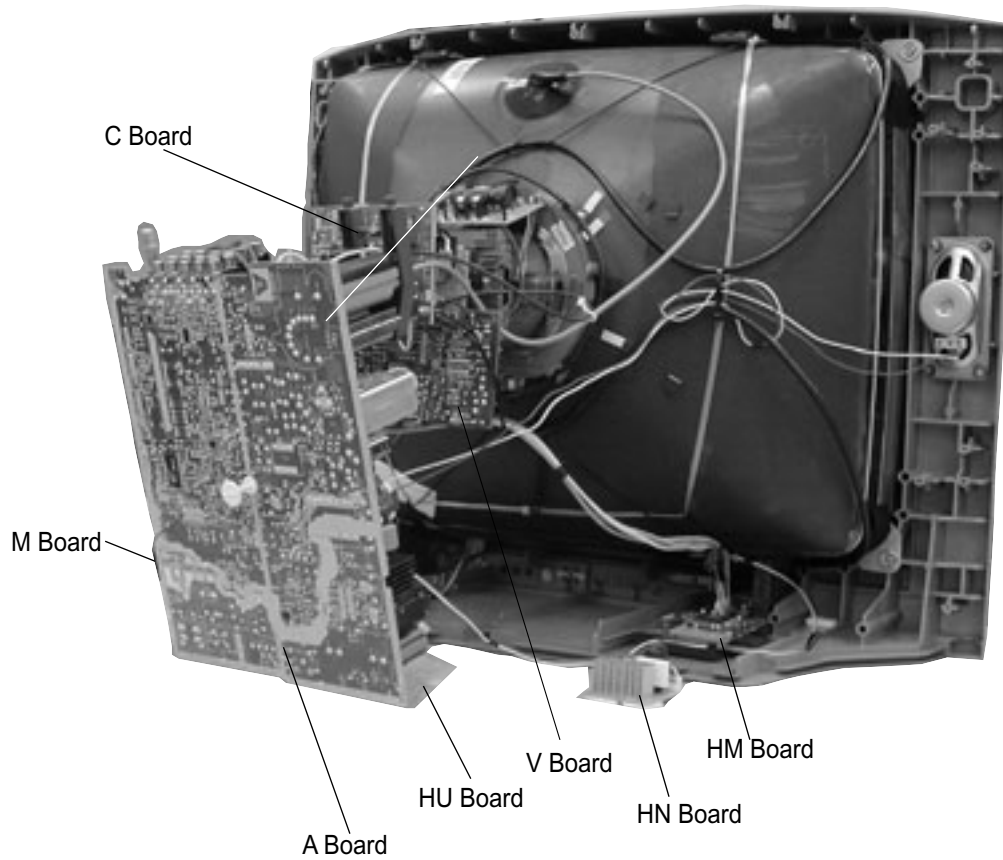

1-4. PICTURE TUBE REMOVAL

WARNING: BEFORE REMOVING THE ANODE CAP

High voltage remains in the CRT even after the power is disconnected. To avoid electric shock, discharge CRT before attempting to remove the anode cap. Short between anode and CRT coated earth ground strap.

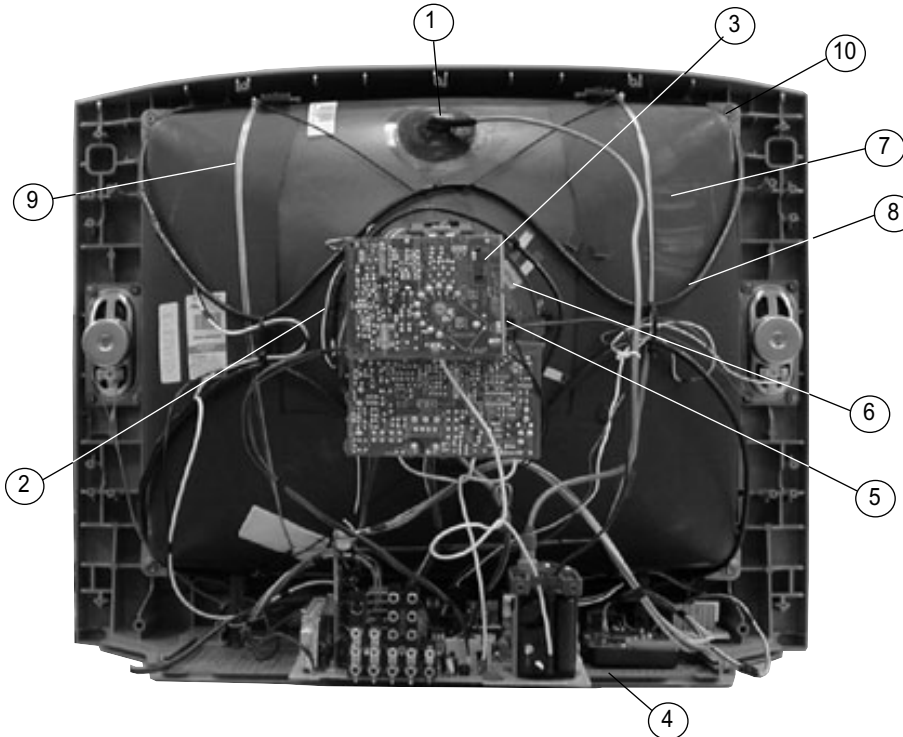
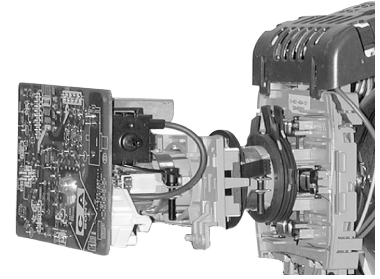

1. Discharge the anode of the CRT and remove the anode cap.
2. Unplug all interconnecting leads from the deflection yoke, neck assembly, degaussing coils and CRT grounding strap.
3. Remove the C Board from the CRT.
4. Remove the chassis assembly.
5. Loosen the neck assembly fixing screw and remove.
6. Loosen the deflection yoke fixing screw and remove.
7. Place the set with the CRT face down on a cushion and remove the degaussing coil holders.
8. Remove the degaussing coils.
9. Remove the CRT grounding strap and spring tension devices.
10. Unscrew the four CRT fixing screws [located on each CRT corner] and remove the CRT [Take care not to handle the CRT by the neck].

ANODE CAP REMOVAL PROCEDURE

WARNING: High voltage remains in the CRT even after the power is disconnected. To avoid electric shock, discharge CRT **before** attempting to remove the anode cap. Short between anode and coated earth ground strap of CRT.

NOTE: After removing the anode cap, short circuit the anode of the picture tube and the anode cap to either the metal chassis, CRT shield, or carbon painted on the CRT.

REMOVAL PROCEDURES

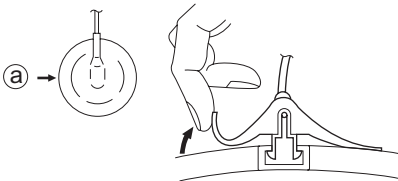

Turn up one side of the rubber cap in the direction indicated by arrow (a) .

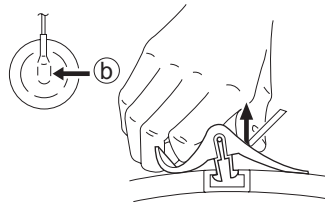

Use your thumb to pull the rubber cap firmly in the direction indicated by arrow (b) .

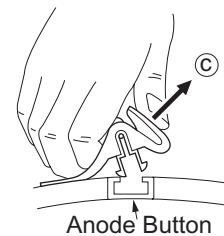

When one side of the rubber cap separates from the anode button, the anode cap can be removed by turning the rubber cap and pulling it in the direction of arrow (c) .

HOW TO HANDLE AN ANODE CAP

1. Do not use sharp objects which may cause damage to the surface of the anode cap.
2. To avoid damaging the anode cap, do not squeeze the rubber covering too hard. A material fitting called a shatter-hook terminal is built into the rubber.
3. Do not force turn the foot of the rubber cover. This may cause the shatter-hook terminal to protrude and damage the rubber.

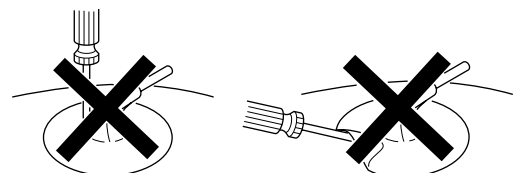

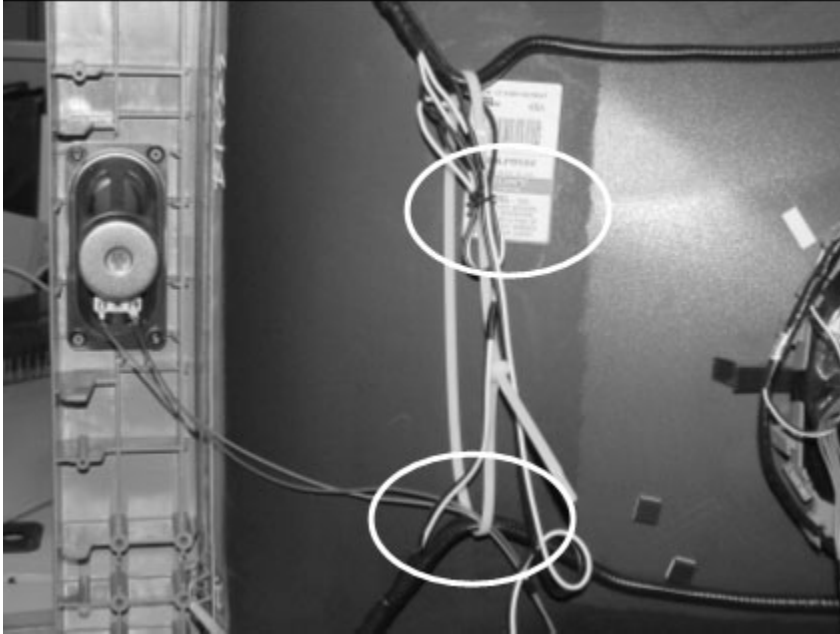
CABLE WIRE DRESSING**KV-27FS320/32FS320/36FS320 MODELS
(DATA NOT AVAILABLE)****KV-32FS120/34FS120 MODELS**

- ① Dress right speaker wire through DGC's tie wrap.
Dress DGC lead wire with a 9mm purple lock



- ② Dress left speaker wire through DGC's tie wrap.

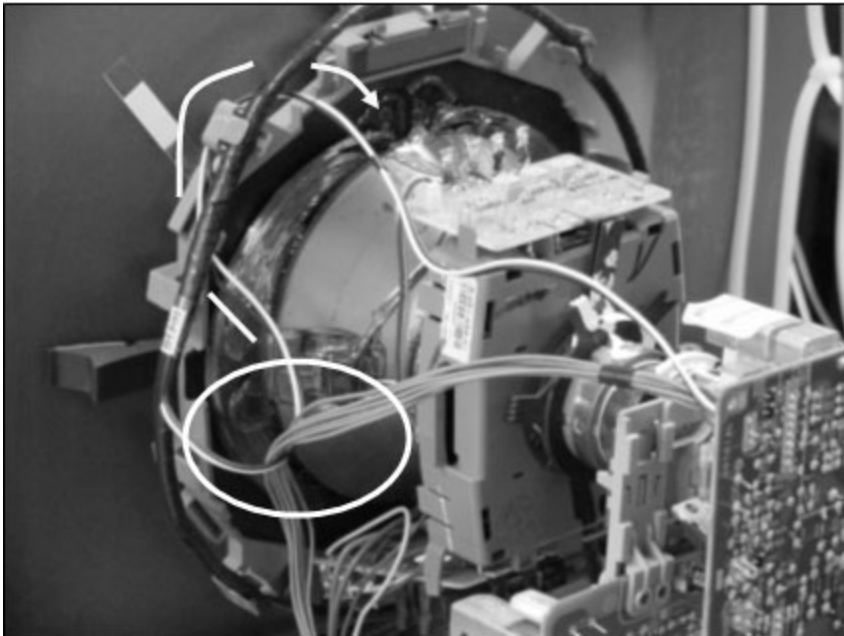

- ③ Dress RGB harness over Rotation coil lead wire.
Dress Rotation coil lead wire over DY clip and through rotation coil as shown in picture.

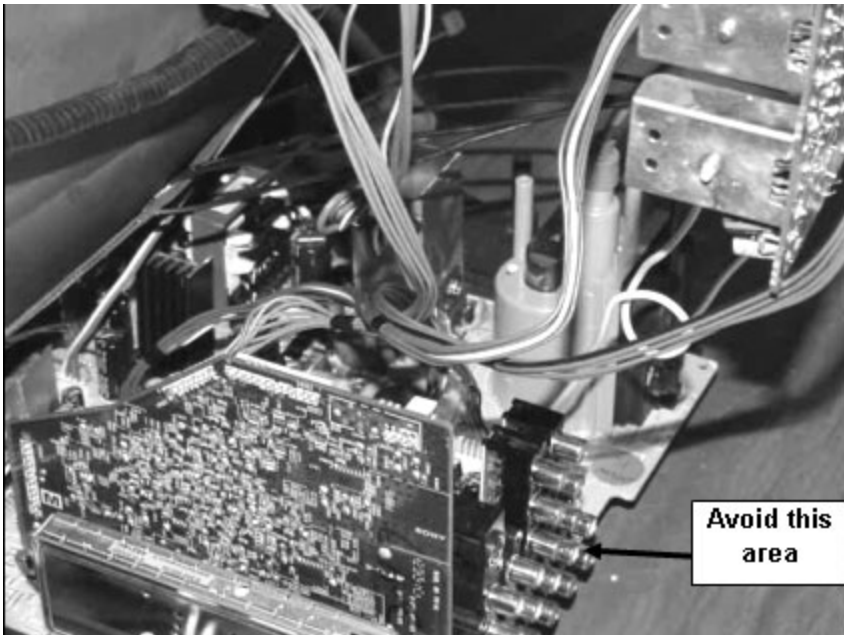

- ④ Dress VM and heaters harnesses over RGB to avoid interference with back cover installation.

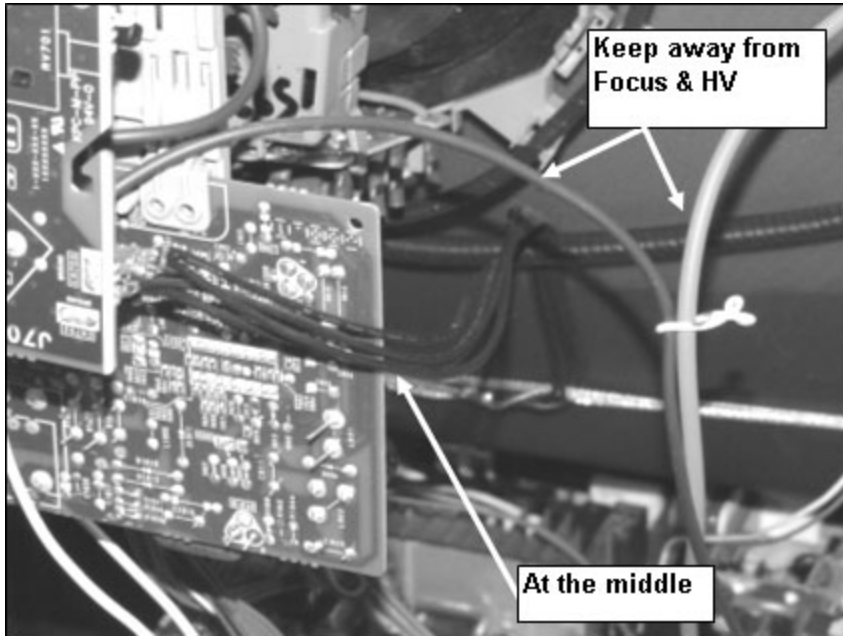

- ⑤ Dress CRT ground wires under DGC and beside VD board at the middle as picture shows, keep away from focus and HV lead wires.

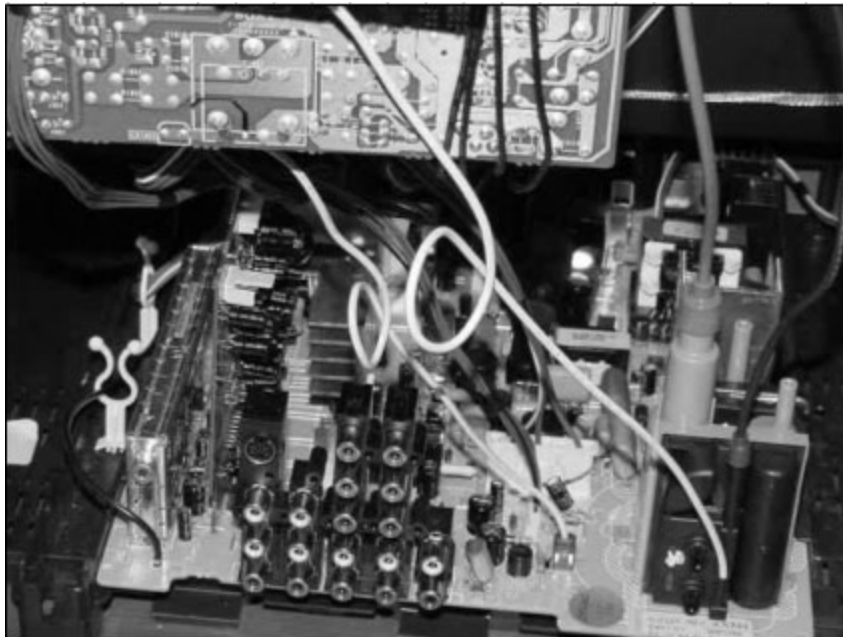

- ⑥ Dress G2 wire and DF wire as shown in picture.

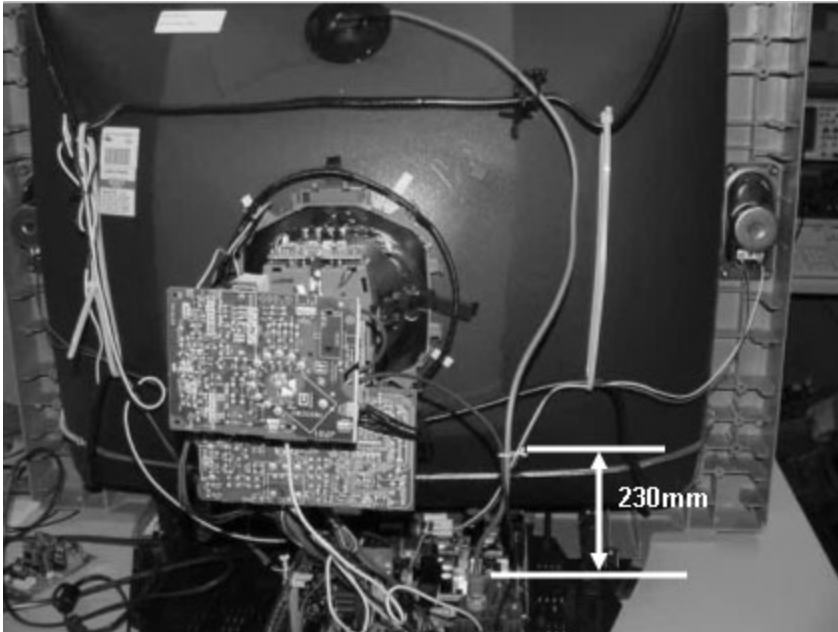

- ⑦ Dress HV cable and focus wire together using a 5mm purse lock (3-703-981-02).
Install purse lock over carbon paint edge.

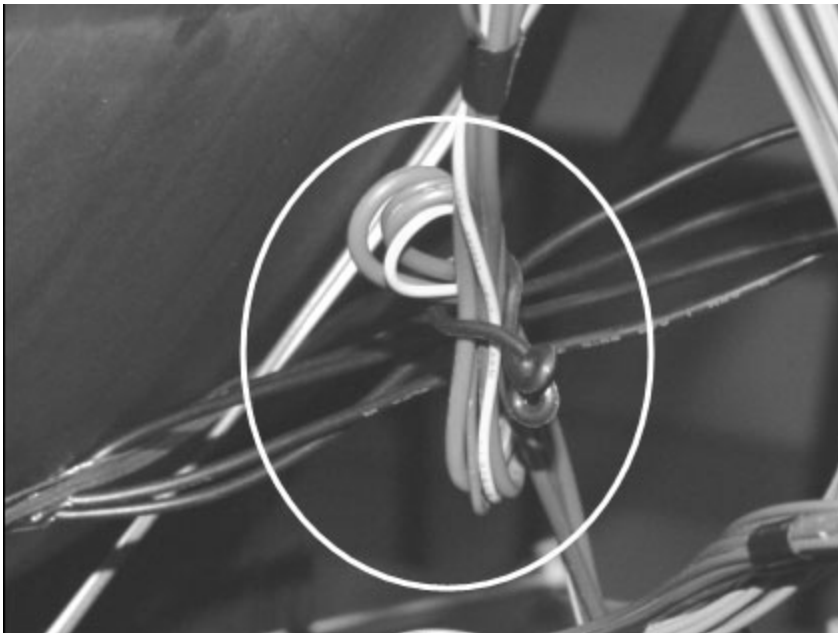

- ⑧ Dress DY lead wire with a 9mm purse lock (3-703-982-02)

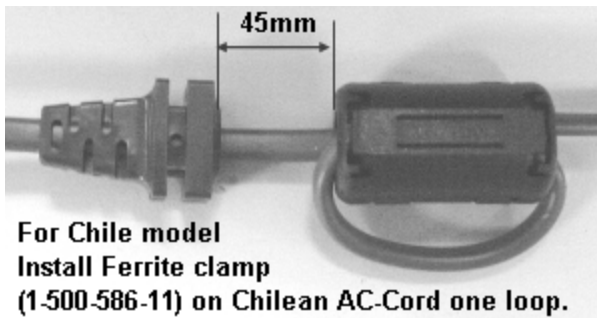
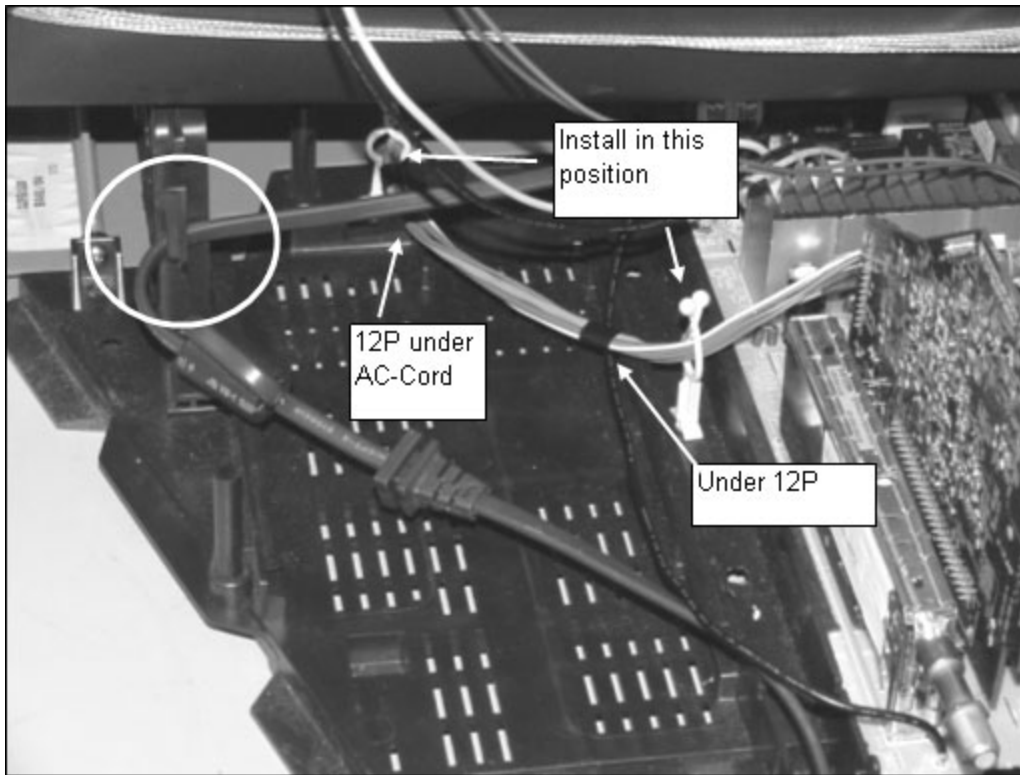

- ⑨ Dress AC-Cord into CRT support hook as shown in picture.
Dress 12P video harness through bottom board's purse locks and under AC-Cord.
Uninstall purse locks as shown in picture.
Dress lightning wire under 12P harness.

KV-36FS120/38FS120 MODELS

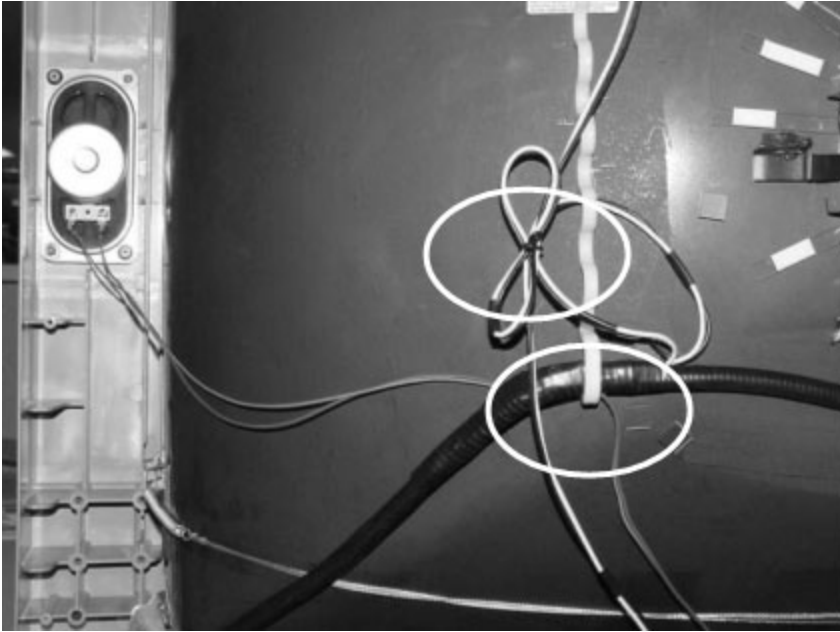

- ① Dress right speaker wire through DGC band.
Dress DGC lead wire with a 9mm purse lock

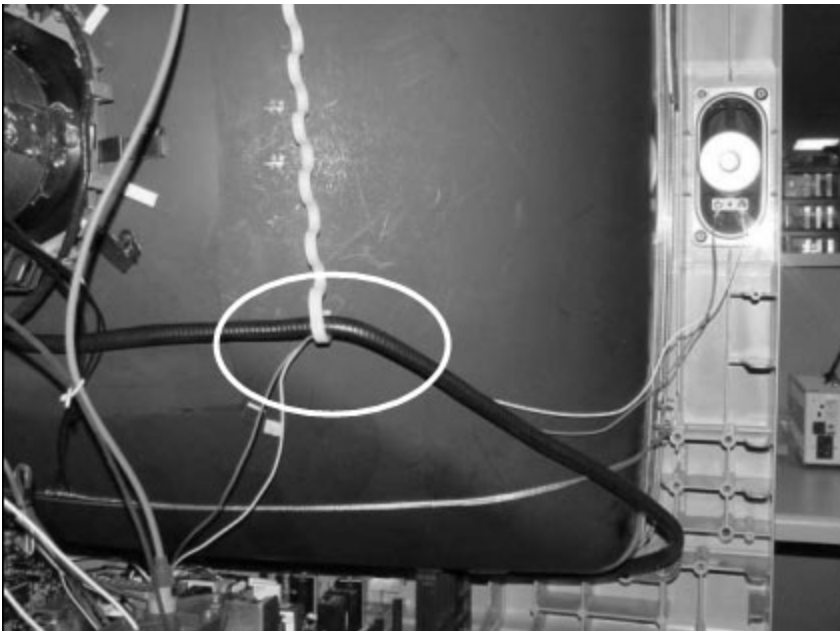

- ② Dress left speaker wire through DGC band

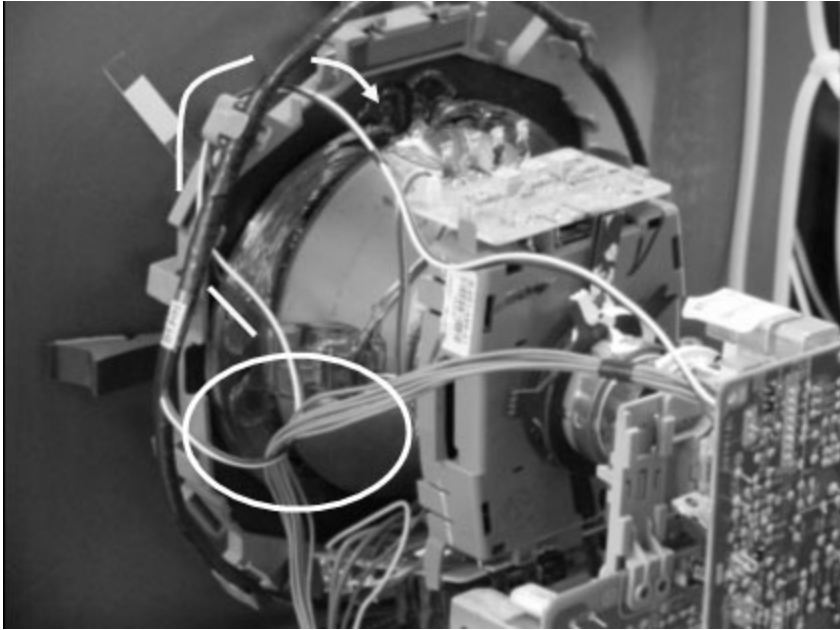

- ③ Dress RGB harness over Rotation coil lead wire.
Dress Rotation coil lead wire over DY clip and through rotation coil as shown in picture.

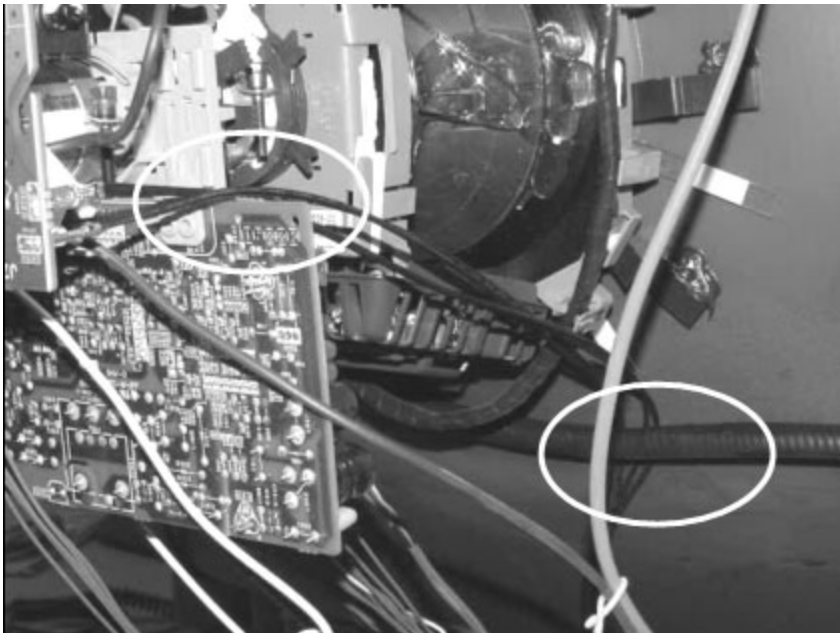

- ④ Dress earth ground wires under DGC and over VD board.

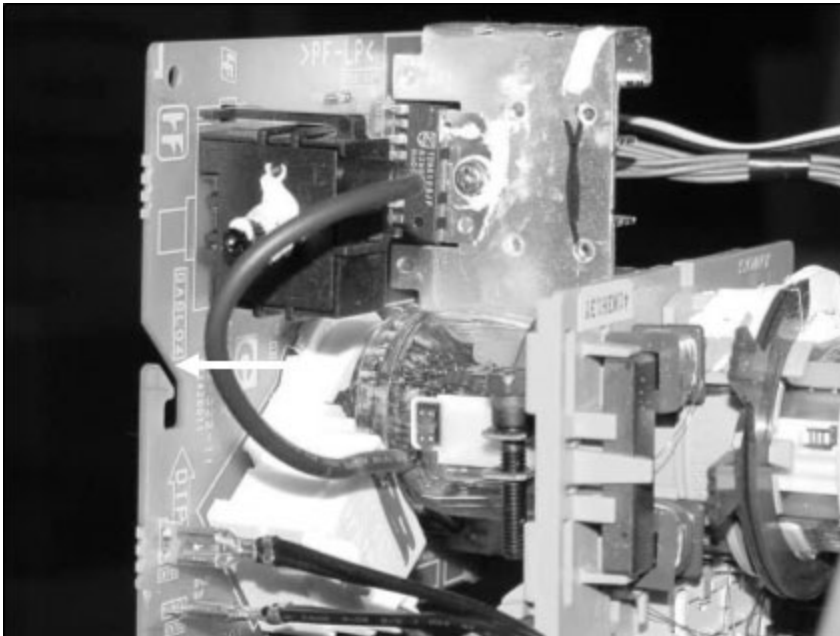

⑤ Bend H-Stat wire towards C board.

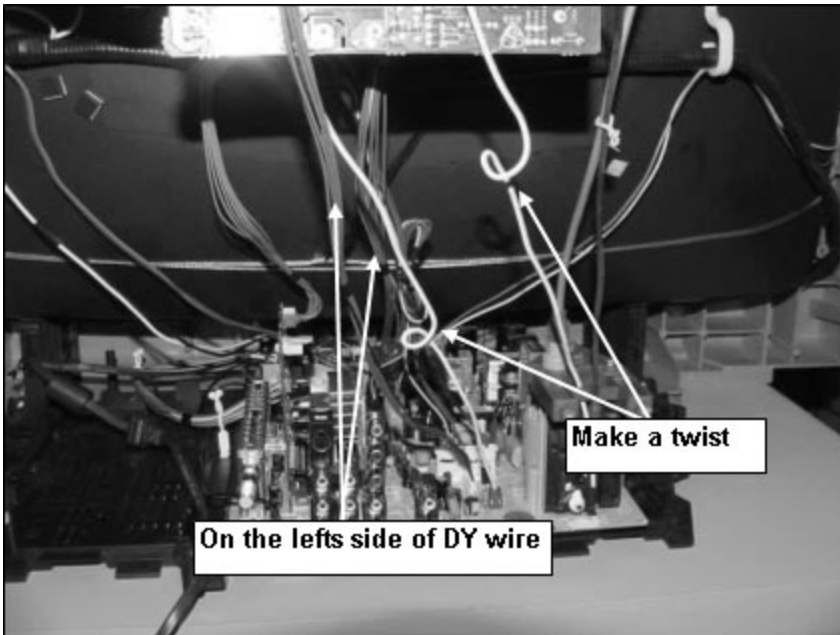

⑥ Dress G2 wire and DF wire as shown in picture.
Dress heaters and VM harnesses on the left side of DY lead wire

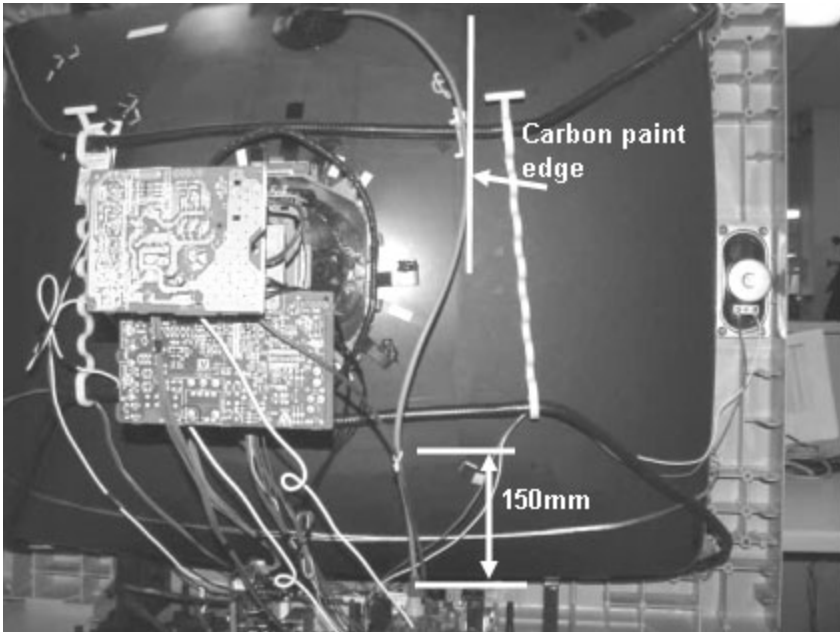

- ⑦ Dress HV cable and focus wire together using a 5mm purse lock, install purse lock 150mm±10 from rubber cap .

Dress HV through standing holder, install holder on CRT's carbon paint edge

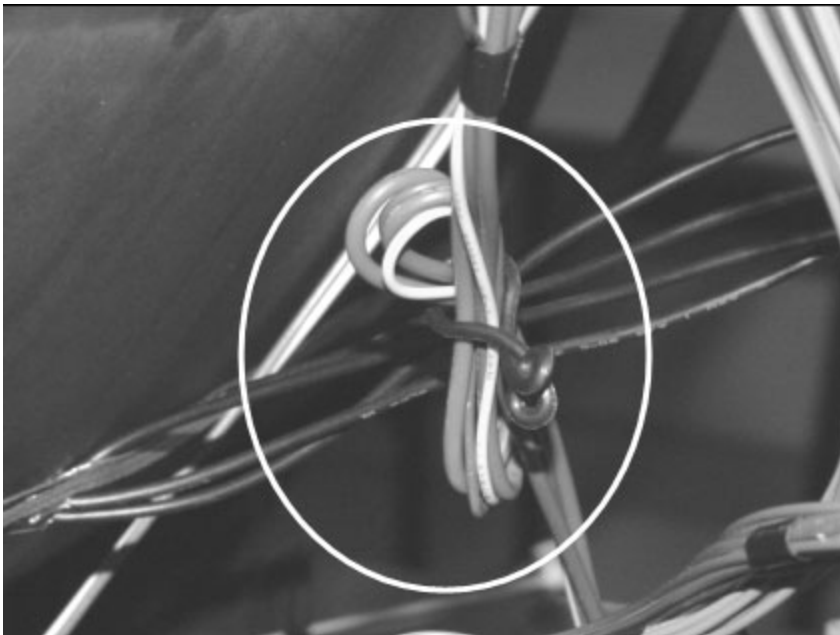

- ⑧ Dress DY lead wire with a 9mm purse lock (3-703-982-02)

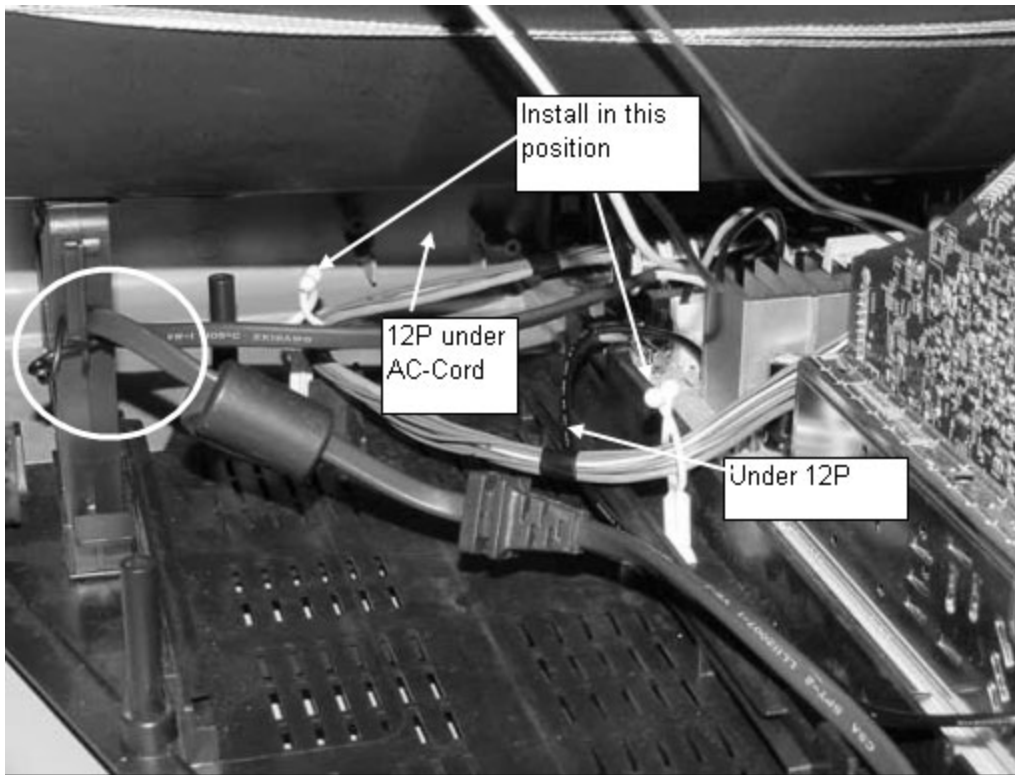

- ⑨ Dress AC-Cord into CRT support hook using a 9mm purse lock as shown in picture.
 Dress 12P video harness through bottom board's purse locks and under AC-Cord. Install purse locks as shown in picture.
 Dress lightning wire under 12P harness.

SECTION 2: SET-UP ADJUSTMENTS

The following adjustments should be made when a complete realignment is required or a new picture tube is installed.

These adjustments should be performed with rated power supply voltage unless otherwise noted.

Set the controls as follows unless otherwise noted:

VIDEO MODE: Pro

PICTURE CONTROL: Normal

BRIGHTNESS CONTROL: Normal

Perform the adjustments in order as follows:

1. Beam Landing
2. Convergence
3. Focus
4. Screen (G2)
5. White Balance

Note Test Equipment Required:

1. Color Bar Pattern Generator
2. Degausser
3. DC Power Supply
4. Digital Multimeter

2-1. BEAM LANDING

Before beginning adjustment procedure:

1. Degauss the entire screen.
2. Feed in the white pattern signal.

ADJUSTMENT PROCEDURE

1. Input a raster signal with the pattern generator.
2. Loosen the deflection yoke mounting screw, and set the purity control to the center as shown below:

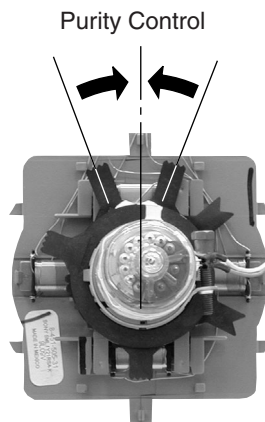

3. Turn the raster signal of the pattern generator to green.
4. Move the deflection yoke backward, and adjust with the purity control so that green is in the center and red and blue are even on both sides.

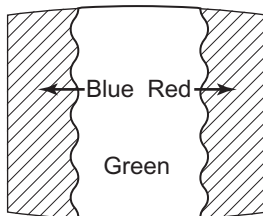

5. Move the deflection yoke forward, and adjust so that the entire screen becomes green.

6. Switch over the raster signal to red and blue and confirm the condition.
7. When the position of the deflection yoke is determined, tighten it with the deflection yoke mounting screw.
8. If landing at the corner is not right, adjust by using the disk magnets.

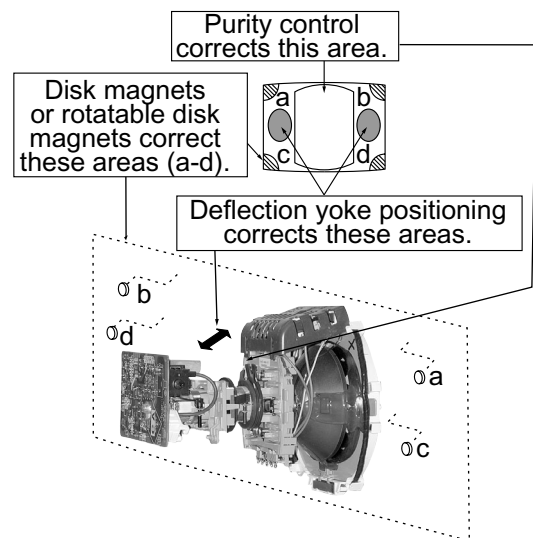
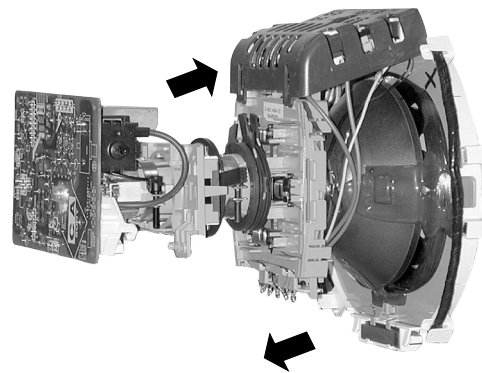

2-2. CONVERGENCE

Before starting convergence adjustments:

- 1 Perform FOCUS, VLIN and VSIZE adjustments.
2. Set BRIGHTNESS control to minimum.
3. Feed in dot pattern.

VERTICAL STATIC CONVERGENCE

1. Adjust V. STAT magnet to converge red, green and blue dots in the center of the screen.

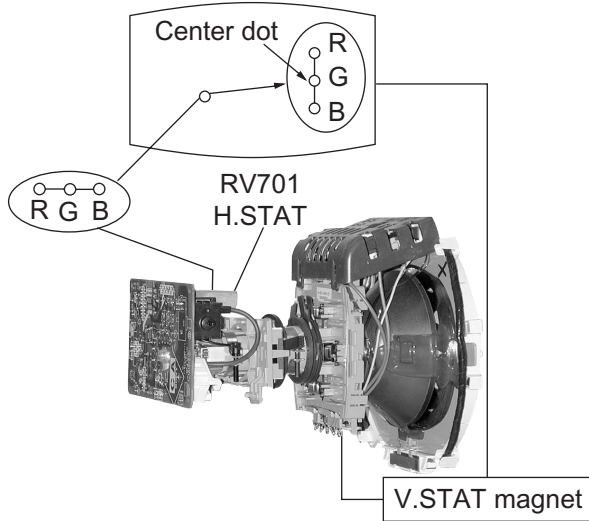

2. Tilt the V. STAT magnet and adjust static convergence to open or close the V. STAT magnet.

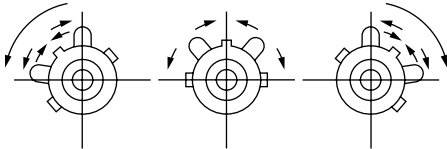

When the V. STAT magnet is moved in the direction of arrow a and b, red, green, and blue dots move as shown below:

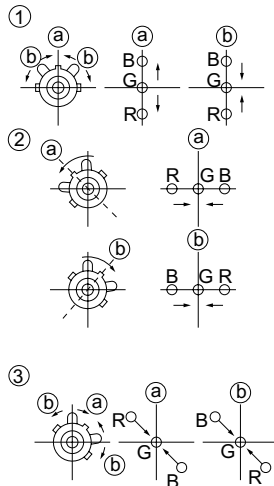

HORIZONTAL STATIC CONVERGENCE

If the blue dot does not converge with the red and green dots, perform the following:

1. Move H STAT VR magnet (a) to correct insufficient H.Static convergence.

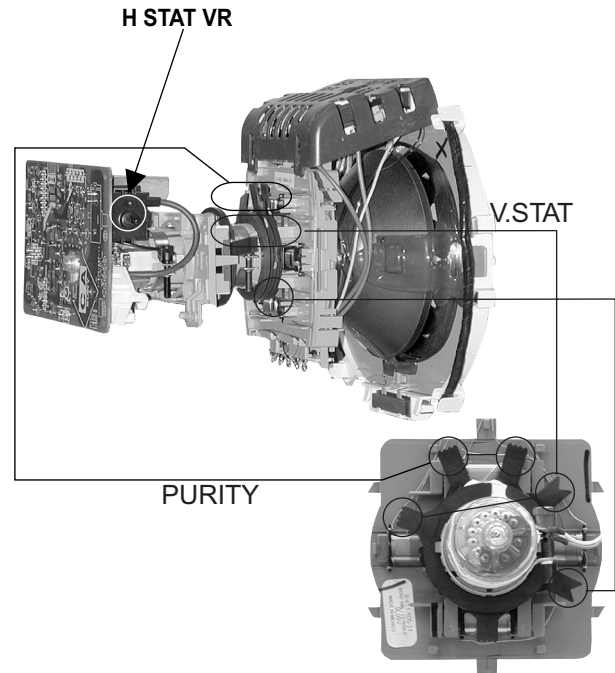

DYNAMIC CONVERGENCE ADJUSTMENT

Before performing this adjustment, perform Horizontal and Vertical Static Convergence Adjustment.

1. Slightly loosen deflection yoke screw.
2. Remove deflection yoke spacers.
3. Move the deflection yoke for best convergence as shown below:

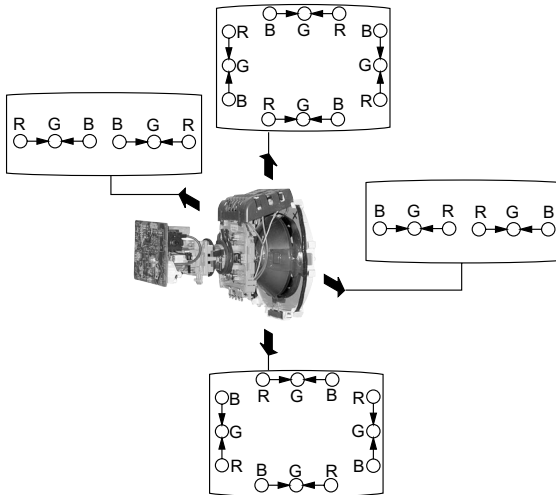

4. Tighten the deflection yoke screw.
5. Install the deflection yoke spacers.

TLH PLATE ADJUSTMENT

1. Input crosshatch pattern.
2. Adjust PICTURE QUALITY to standard, PICTURE and BRIGHTNESS to 50%, and OTHER to standard.
3. Adjust the Horizontal Convergence of red and blue dots by tilting the TLH plate on the deflection yoke.

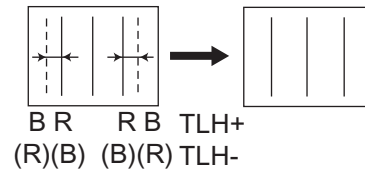
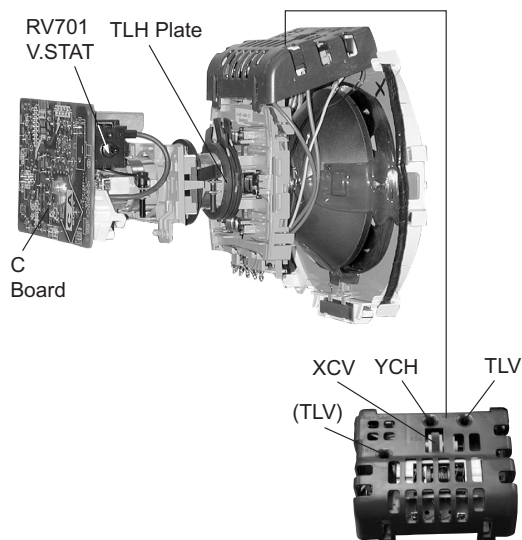

4. Adjust XCV core to balance X axis.
5. Adjust YCH VR to balance Y axis.
6. Adjust vertical red and blue convergence with V.TILT (TLV VR.)
Note: Perform adjustment 3-6 while tracking items 1 and 2.

SCREEN-CORNER CONVERGENCE

1. Affix a permalloy assembly corresponding to the misconverged areas:

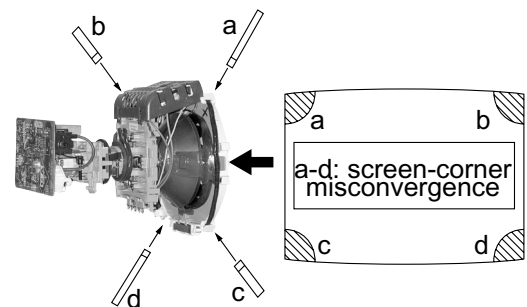

2-3. FOCUS

1. Adjust FOCUS control for best pictures.

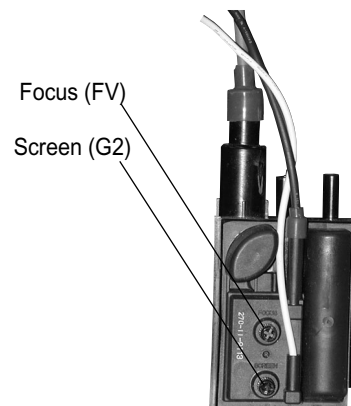

2-4. SCREEN (G2)

1. Input a dot pattern.
2. Set the PICTURE and BRIGHTNESS controls at minimum and COLOR control at normal.
3. Adjust SBRT, GCUT, BCUT in service mode with an oscilloscope as shown below so that voltages on the red, green, and blue cathodes are $172 \pm 2\text{VDC}$.

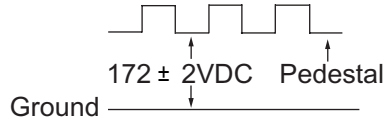

4. Observe the screen and adjust SCREEN (G2) VR in FBT to obtain the faintly visible background of dot signal.

2-5. METHOD OF SETTING THE SERVICE ADJUSTMENT MODE

SERVICE MODE PROCEDURE

1. Standby mode (power off).
2. Press **Display** → Channel **5** → Sound Volume **+** → Power on the Remote Commander (press each button within a second).

SERVICE ADJUSTMENT MODE ON

1. The CRT displays the time being adjusted.

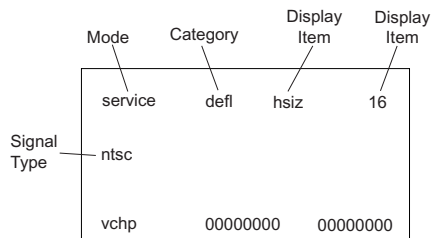

2. Press **1** or **4** on the Remote Commander to select the time.
3. Press **3** or **6** on the Remote Commander to change the data.
4. Press **MUTING** then **ENTER** to save into the memory.

SERVICE ADJUSTMENT MODE MEMORY

Turn the set off then on to exit Service Adjustment Mode.

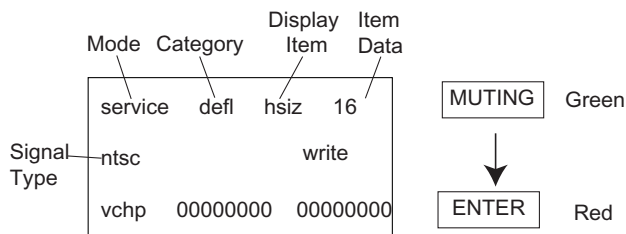



2-6. WHITE BALANCE ADJUSTMENTS

1. Input an entire white signal with burst.
2. Set to Service Adjustment Mode.
3. Set the PICTURE and BRIGHTNESS to minimum.
4. Adjust with SBRT if necessary.
5. Select GCUT and BCUT with **1** and **4**.
6. Adjust with **3** and **6** for the best white balance.
7. Set the PICTURE and BRIGHTNESS to maximum.
8. Select GDRV and BDRV with **1** and **4**.
9. Adjust with **3** and **6** for the best white balance.
10. Press **MUTING** then **ENTER** to save into the memory.

SECTION 3: SAFETY RELATED ADJUSTMENTS

3-1. R530, R531 CONFIRMATION METHOD (HV HOLD-DOWN CONFIRMATION) AND READJUSTMENTS

The following adjustments should always be performed when replacing the following components which are marked with  on the schematic diagram:

Part Replaced ()	Adjustment ()
C531, C532, D519, D520, D521, IC501, IC600, PH602, R529, R530, R531, R532, R533, R550, T503 (FBT), T504 (DFT)	HV HOLD-DOWN R530, R531

PREPARATION BEFORE CONFIRMATION

- Using a Variac, apply AC input voltage: 120 +/- 2.0 VAC.
- Turn the POWER switch ON.
- Input a white signal and set the PICTURE and BRIGHT controls to maximum.
- Confirm that the voltage of more than 23.0 VDC appears between TP85 and ground on the A Board.

HOLD-DOWN OPERATION CONFIRMATION

- Connect the current meter between Pin 11 of the FBT (T503) and the PWB land where Pin 11 would normally attach. (See Figure 1).
- Input a dot signal and set PICTURE and BRIGHTNESS to minimum: IABL = $2175 + 100 / -325 \mu\text{A}$.
- Confirm the voltage of A Board TP91 is $134.6 \pm 1.0 \text{ VDC}$.
- Connect the digital voltmeter and the DC power supply to TP85 and ground. (See Figure 1).
- Increase the DC power voltage gradually until the picture blanks out.
- Turn DC power source off immediately.
- Read the digital voltmeter indication:
KV-27FS320 Only (standard = $24.78 + 0.0 / - 0.1 \text{ VDC}$).
All except KV-27FS320 (standard = $27.24 + 0.0 / - 0.1 \text{ VDC}$).
- Input a white signal and set PICTURE and BRIGHTNESS to maximum: IABL = $2175 + 100 / -325 \mu\text{A}$.
- Repeat steps 4 to 7.

HOLD-DOWN READJUSTMENT

If the setting indicated in Step 2 of Hold-Down Operation Confirmation cannot be met, readjustment should be performed by altering the resistance value of R530, R531 component marked with .

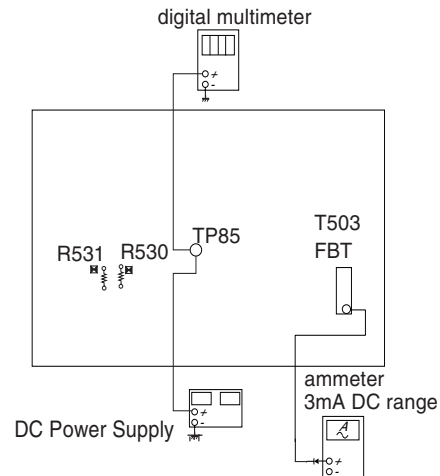



Figure 1

3-2. B+ VOLTAGE CONFIRMATION AND ADJUSTMENT

Always perform the following adjustments when replacing the following components, which are marked with  on the schematic diagram on the A Board:

Adjustment ()
A BOARD IC600, PH602

- Using a Variac, apply AC input voltage: $130 + 2.0 / -0.0 \text{ VAC}$
- Input a monoscope signal.
- Set the PICTURE control and the BRIGHT control to minimum.
- Confirm the voltage on A Board between TP23 and ground is less than 136.5 VDC.
- If step 4 is not satisfied, replace R530 and R531 on A Board and repeat the above steps.

SECTION 4: CIRCUIT ADJUSTMENTS

ELECTRICAL ADJUSTMENTS BY REMOTE COMMANDER

Use the Remote Commander (RM-Y195, RM-Y196) to perform the circuit adjustments in this section.

Test Equipment Required: 1. Pattern generator 2. Frequency counter 3. Digital multimeter 4. Audio oscillator

4-1. SETTING THE SERVICE ADJUSTMENT MODE

- Standby mode (Power off).
- Press the following buttons on the remote commander within a second of each other:

Display → **Channel 5** → **Sound Volume +** → **Power**

SERVICE ADJUSTMENT MODE ON

- The CRT displays the item being adjusted.

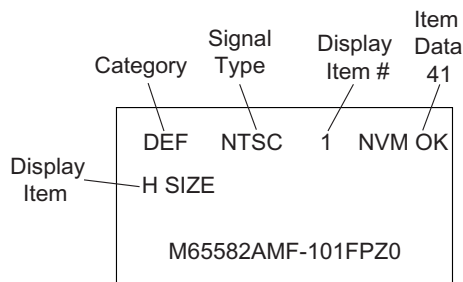

- Press **1** or **4** on the Remote Commander to select the item.
- Press **3** or **6** on the Remote Commander to change the data.
- Press **MUTING** then **ENTER** to write into memory.

SERVICE ADJUSTMENT MODE MEMORY

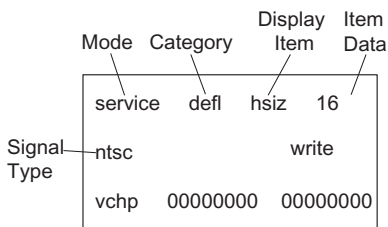

- Press **8** then **ENTER** on the Remote Commander to initialize.

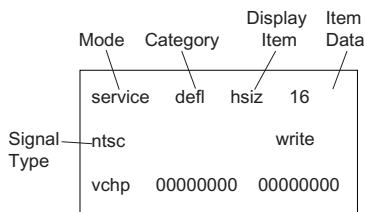

Carry out Step 1 when adjusting IDs 0-7 and when replacing and adjusting IC002

- Press **MUTING** then **ENTER** to write into memory.
- Turn set off then on to exit Service Adjustment Mode.

4-2. MEMORY WRITE CONFIRMATION METHOD

- After adjustment, pull out the plug from the AC outlet, then replace the plug in the AC outlet again.
- Turn the power switch ON and set to Service Mode.
- Call the adjusted items again to confirm they were adjusted.

4-3. REMOTE ADJUSTMENT BUTTONS AND INDICATORS

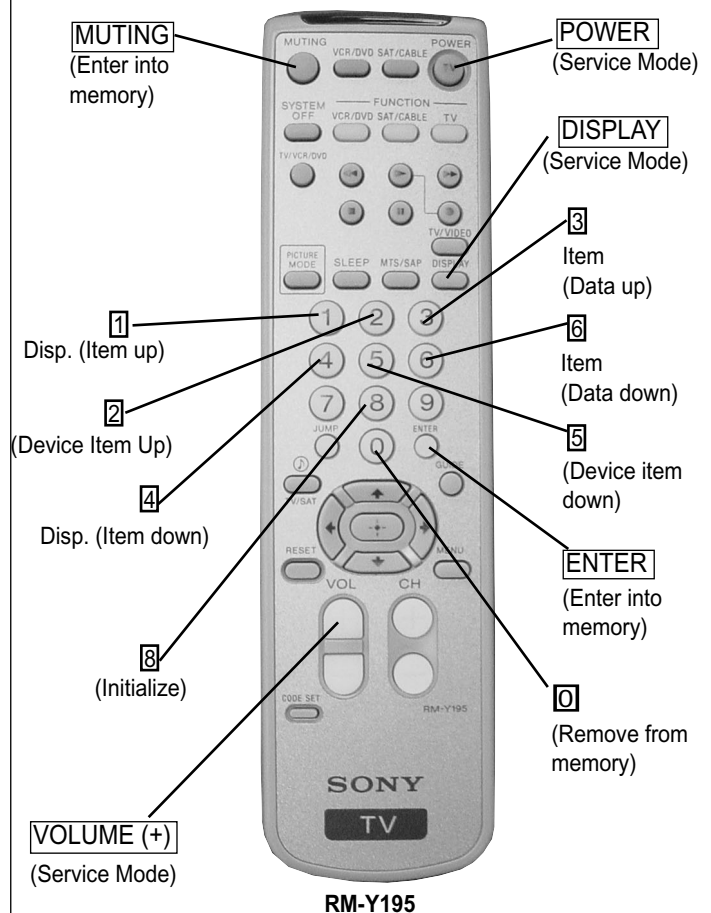

4-4. SERVICE DATA LISTS

**KV-27FS320 SERVICE DATA
(DATA NOT AVAILABLE)**

KV-32FS320 SERVICE DATA

Service Group	Fix/ Var	No.	Name	Description	Common Init Data
VERSION	Fix	0	VER	Microprocessor version information	=

= Means same as other register
 * Means change when tv turn on

Service Group	Fix/ Var	No.	Name	Description	Common Init Data	RF Init Data	Composite V Init Data
DEF	Var	1	HSIZ	H SIZE(EW DC)	41	35	35
	Var	2	HPOS	H POSITION	15	13	13
	Var	3	VSIZ	V RAMP SIZE	25	22	23
	Var	4	VPOS	V POSITION(RAMP DC)	30	31	31
	Var	5	VLIN	V LINEARITY	37		
	Var	6	SCOR	S CORRECTION	39		
	Var	7	VBOW	BOW	37		
	Var	8	VANG	ANGLE	40		
	Var	9	TRAP	EW TRAPESIUM	29		
	Var	10	PAMP	EW PIN	31		
	Var	11	UPIN	UPPER PIN	30		
	Var	12	LPIN	LOWER PIN	31		
	Var	13	TROT	TROT	128		
	Var	14	HBLK	H BLK mode select	0		
	Fix	15	RBLK	HBLK rear timing	33	30	25
	Var	16	LBLK	HBLK front timing	58	55	55
	Fix	17	VBLK	V BLK width	3		
	Fix	18	HMSK	TOP VEND(when MACROVISION)prevent OFF	0		
	Fix	19	HDW	H PULSE WIDTH(25u/19u)	1		
	Fix	20	AFC	AFC GAIN	0		
	Fix	21	AFC1	AFC1 TIME CONSTANT	0	7	0
	Fix	22	AFCW	AFC1 PULL IN WIDE	1		
	Fix	23	CDMD	V DET WINDOW SW TIMING	1		
	Fix	24	HSS	SYNC SLICE LEVEL(H sepa)	0		
	Fix	25	VSS	SYNC SLICE LEVEL(V sepa)	3		
	Fix	26	SLUD	Auto Slice level UP/DOWN	0		
	Fix	27	JPSW	Jump SW	0		
	Fix	28	HOSC	H VCO fo offset ADJUST OFFSET	3		
	Fix	29	EHT	EHT	4		
	Fix	30	EHTG	EHT MODE	1		

KV-32FS320 SERVICE DATA

Service Group	Fix/ Var	No.	Name	Description	Common Init Data
16 : 9	Fix	1	VSIZ	V RAMP SIZE	36
	Fix	2	VPOS	V POSITION(RAMP DC)	33
	Fix	3	VLIN	V LINEARITY	26
	Fix	4	SCOR	S CORRECTION	28
	Fix	5	TRAP	EW TRAPESIUM	26
	Fix	6	PAMP	EW PIN	16
	Fix	7	UPIN	UPPER PIN	31
	Fix	8	LPIN	LOWER PIN	32
	Fix	9	ABLG	ABL GAIN	1
	Fix	10	SCON	SUB CONTRAST LEVEL	13
	Fix	11	VPW	Jump Pulse Width	1

Service Group	Fix/ Var	No.	Name	Description	Common Init Data	RF Init Data	Composite V Init Data	YUV Init Data	Memory Stick Init Data
VP1	Fix	1	RDRV	R DRIVE	84				
	Var	2	GDRV	G DRIVE when Color Temp. is "Cool" and "Neutral"	70			70	68
	Var	3	BDRV	B DRIVE when Color Temp. is "Cool" and "Neutral"	68			67	66
	Var	4	RCUT	Hardware AKB(R) CMP DATA	100				
	Var	5	GCUT	Hardware AKB(G) CMP DATA when Color Temp. is "Cool" and "Neutral"	71			71	70
	Var	6	BCUT	Hardware AKB(B) CMP DATA when Color Temp. is "Cool" and "Neutral"	62			61	60
	Var	7	SCON	SUB CONTRAST LEVEL	12				1
	Var	8	SHUE	SUB TINT(HUE)		10		9	8
	Var	9	SCOL	SUB COLOR LEVEL		6		7	26
	Var	10	SBRT	SUB BRIGHTNESS	15				20
	Fix	11	RON	R OUTPUT ON (0:R Output OFF 1:R Output ON)	1				
	Fix	12	GON	G OUTPUT ON (0:G Output OFF 1:G Output ON)	1				
	Fix	13	BON	B OUTPUT ON (0:B Output OFF 1:B Output ON)	1				
	Fix	14	BLLV	BLUE STRETCH(00:no <-> 11:deep) only Color Temp "Cool"	1				
	Fix	15	MTRX	MATRIX RATIO SELECT	1				

KV-32FS320 SERVICE DATA

Service Group	Fix/ Var	No.	Name	Description	Common Init Data	RF Init Data	Composite V Init Data	YUV Init Data	Memory Stick Init Data
VP1	Fix	16	AXIS	R-Y PHASE OFFSET	52				
	Fix	17	SSHO	SUB SHARPNESS GAIN(OVER) RF/VIDEO		3	2	2	3
	Fix	18	SSHP	SUB SHARPNESS GAIN(PRE) RF/VIDEO		11	11	13	13
	Fix	19	SHPF	SHRPNNESS fo(00:2 CLK <-> 11:5 CLK)		0	1	0	0
	Fix	20	SHCL	SHARPNESS CORING LEVEL	1				
	Fix	21	SHMX	SHARPNESS LIMITTER LEVEL	15				
	Fix	22	AKBD	AKB Self Diagnostic Counter(@1sec)	5				
	Fix	23	AKBS	AKB Switch (0 : AKB OFF 1 : H/W AKB ON)	1				
	Fix	24	REFP	AKB REFPLS timing ("0"Fix when 16:9On)	0				
	Fix	25	YNRC	YNR LIMITER LEVEL	15				
	Fix	26	BKON	BLACK STRETCH ON	1				
	Fix	27	BKRC	BLACK STRETCH DETECTOR TIME CONSTANT1	=				
	Fix	28	BKDP	BLACK STRETCH START POINT	=				
Fix	29	BKSP	BLACK STRETCH POINT	=					

KV-32FS320 SERVICE DATA

Service Group	Fix/ Var	No.	Name	Description	Common Init Data	RF Init Data	Composite V Init Data	YUV Init Data	Memory Stick Init Data
VP2	Fix	1	VMOF	VM LEVEL at "Off" Setting	2				
	Fix	2	VMLO	VM LEVEL at "Low" Setting	5				
	Fix	3	VMHI	VM LEVEL at "High" Setting	11				
	Fix	4	VMDL	VM DELAY		10	10	6	6
	Fix	5	VMPL	VM PORALITY	1				
	Fix	6	VMWD	VM WIDTH	0				
	Fix	7	VMCL	VM CORING LEVEL	0				
	Fix	8	VMMX	VM LIMITER LEVEL	15				
	Fix	9	CKLV	COLOR KILLER VTH	1				
	Fix	10	CKON	FORCE KILLER	0				
	Fix	11	ALFA	ADAPTIVE DET SENSITIVITY	2				
					YC SEPA FORCE				
	Fix	12	YCMD	SELECT(00:ADAPTIVE 01:H 10:V 11:HV)	0				
	Fix	13	VACL	V APERTURE CORING LEVEL	0				
	Fix	14	VAGA	V APERTURE GAIN LEVEL	=				
	Fix	15	VAMX	V APERTURE LIMITER LEVEL	15				
	Fix	16	GAMM	GAMMA(00:no <-->11:deep)	=				
	Fix	17	YDLY	Y DELAY TIME	3				
	Fix	18	CDLY	C DELAY	2				
	Fix	19	YOFF	Y OUTPUT MUTE	0				
	Fix	20	BGPP	BGP(for C DECODER)TIMING	11				
	Fix	21	NRCH	NOISE DET VTH1	3				
	Fix	22	NRCL	NOISE DET VTH1	255				
	Fix	23	NRVL	NOISE DET VTH1	255				
	Fix	24	NRVH	NOISE DET VTH1	255				
	Fix	25	GDOF	G DRIVE OFFSET only Color Temp. "Warm"	18				
	Fix	26	BDOF	B DRIVE OFFSET only Color Temp. "Warm"	31				
	Fix	27	GCOF	GCUT CMP DATA OFFSET only Color Temp. "Warm"	2				
	Fix	28	BCOF	BCUT CMP DATA OFFSET only Color Temp. "Warm"	4				
	Fix	29	DCTV	DCTTRANSFER VTH	3				
Fix	30	DCTG	DCTTRANSFER GAIN	=					

KV-32FS320 SERVICE DATA

Service Group	Fix/ Var	No.	Name	Description	Common Init Data
NR	Var	1	SCOL	SUB COLOR LEVEL for NR	4
	Fix	2	SHCL	SHARPNESS NOISE CORING LEVEL for NR	15
	Fix	3	SHMX	SHARPNESS LIMITTER LEVEL for NR	7
	Fix	4	YNRC	YNR LIMITER LEVEL for NR	7
	Fix	5	VMHI	VM LEVEL at "High" Setting for NR	7
	Fix	6	VMCL	VM CORING LEVEL for NR	0
	Fix	7	VMMX	VM LIMITER LEVEL for NR	7
	Fix	8	VAGA	V APERTURE GAIN LEVEL for NR	0
	Fix	9	GAMM	GAMMA(00:no <-->11:deep) for NR	0
	Fix	10	YNRS	YNR ON for NR	1
	Fix	11	WSTH	WEAK_SIGNAL VTH for NR	7
	Fix	12	WSVA	WEAK SIGNAL VIDEO ATT for NR	0
	Fix	13	WSCA	WEAK SIGNAL CHROMA ATT for NR	5

Service Group	Fix/ Var	No.	Name	Description	Common Init Data	STANDARD Init Data	MOVIE Init Data	PRO Init Data
PALETTE	Fix	1	VPIC	Picture	63	50	37	31
	Fix	2	VBRI	Brightness	31	31	28	31
	Fix	3	VCOL	Color	32	31	31	31
	Fix	4	VHUE	Hue	31	31	31	31
	Fix	5	VSHA	Sharpness	35	37	34	31
	Fix	6	VVM	VM	2	1	1	0
	Fix	7	VTRI	Color Temp	0	1	2	1
	Fix	8	VAPA	Aperture G	7	4	3	0
	Fix	9	VGMA	Gamma	3	2	2	0
	Fix	10	VDCT	DCT LV	12	9	9	2
	Fix	11	BKDP	BLACK STRETCH DEPTH	2	2	1	1
	Fix	12	BKRC	BLACK ST TIME 1 & TIME 2	243	243	244	244
	Fix	13	BKSP	BLACK STRETCH POINT	3	1	1	1
	Fix	14	CONO	CONTRAST OFFSET for RF	1	0	0	0

KV-32FS320 SERVICE DATA

Service Group	Fix/ Var	No.	Name	Description	Common Init Data	16:9 Init Data	YUV Init Data	Memory Stick Init Data
ASIC	Fix	1	YNRS	YNR ON	0			
	Fix	2	CLPS	CLAMP CONTROL SW (0:CLAMP OFF 1:CLAMP AUTO 2:CLAMP ON)	1			
	Fix	3	VMG2	MODULATOR FEEDBACK GAIN CONTROL	1			
	Fix	4	CLPT	CLAMP AUTO ON KEEP TIMER COUNT (@100ms)	15			
	Fix	5	AASL	C DECODER TIME CONSTANT(32,16,8,1H)	2			
	Fix	6	BASL	ACC TIME CONSTANT	0			
	Fix	7	ACTH	ROM HYS	95			
	Fix	8	AVAV	AVE SEL AV	3			
	Fix	9	B2TH	B2COMP	0			
	Fix	10	AMUT	RGB POWER ON MUTE	0			
	Fix	11	PMUT	RGB MUTE(EXCEPT OSD)	1			
	Fix	12	CORL	R CUTOFF lower	0			
	Fix	13	CORH	R CUTOFF upper	1			
	Fix	14	COGL	G CUTOFF lower when Color Temp. is "Cool" and "Neutral"	0			
	Fix	15	COGH	G CUTOFF upper when Color Temp. is "Cool" and "Neutral"	1			
	Fix	16	COBL	B CUTOFF lower when Color Temp. is "Cool" and "Neutral"	0			
	Fix	17	COBH	B CUTOFF upper when Color Temp. is "Cool" and "Neutral"	1			
	Fix	18	ALSP	ACL SPEED	0			
	Fix	19	ALAS	ACL ATTACK SPEED	146			
	Fix	20	ABLG	ABL GAIN	4			
	Fix	21	AKBM	AKB MODE	0			
	Fix	22	AKBP	AKB PULSE HEIGHT	10			
	Fix	23	OSDL	OSD LIMMIT SELECT	0			
	Fix	24	UVG	UV OFFSET CANCELER ON	0			
	Var	25	UOFS	U IN OFFSET	32			31
	Var	26	VOFS	V IN OFFSET	32			29
	Fix	27	AALG	ANALOG ACL GAIN CONTROL	0			
	Fix	28	AALS	ANALOG ACL ON/OFF CONTROL	1			
	Fix	29	UVDT	UVIN DITHER TEST	14			

KV-32FS320 SERVICE DATA

Service Group	Fix/ Var	No.	Name	Description	Common Init Data	16:9 Init Data	YUV Init Data	Memory Stick Init Data
ASIC	Fix	30	HFFR	AFC1 FORCE FREERUN	0			
	Fix	31	HFUP	H FREERUN FREQUENCY UP(700Hz)	0			
	Fix	32	JSWW	Jump Pulse Width	0			
	Fix	33	XF0A	VCXO FREERUN ADJUST	0			
	Fix	34	BGST	BGP(for PLL) TIMING	16		6	6
	Fix	35	XPHA	VCXO PHASE ADJUST	10			
	Fix	36	HRMP	AFC2 TIME CONSTANT	3			
	Fix	37	RPLU	REF PLL TIME CONSTANT	3			
	Fix	38	RPLB	REF PLL TIME CONSTANT	1			
	Fix	39	XF0B	VCXO Fo ADJUST	0			
	Fix	40	RPLS	REF VCO FB LOOP SELECT	0			
	Fix	41	SSM	SyncSepaMasking CONTROL	0			
	Fix	42	VSAG	V-SAG prevent ON	0			
	Fix	43	AFC2	AFC2 GAIN CONTROL	0			
	Fix	44	VRFL	V RAMP FILTER SWITCHING OFF	0			
	Fix	45	XPLU	ACP TIME CONSTANT	1			
	Fix	46	CDM2	V_LOGIC SW	1			
	Fix	47	BGPC	BGP C	0			
	Fix	48	MHDL	BGP SEL	1			
	Fix	49	BFRE	force V FREERUN	0			
	Fix	50	HRPP	FRAMP RRAMP H OUT CONTROL RANGE	2			
	Fix	51	DSCK	DS DAC CLK SW for only Not YUV	0	0		
	Fix	52	VBHK	V BLK HALF KILL only 16:9Off	0			
	Fix	53	VPW	V Pulse Wide	1			
	Fix	54	DTH	DITHER THRESHOLD LEVEL CONTROL at IIC AUTOD=ON	1			
	Fix	55	SLON	LPF SYNC ON	5		5	5
	Fix	56	VSSW	SYNC SLICE LEVEL(V) Wide Window	0			
	Fix	57	AF2S	AFC2 timing SW	0			
	Fix	58	VSL2	Digital V_SYNC_LPF(fall)	1			
	Fix	59	VSL1	Digital V_SYNC_LPF(rise)	0			
	Fix	60	VSHE	V-SHRINK MODE for AV-NoSync	0			
	Fix	61	DSCS	CLOCK DIV SEL	1		0	0
	Fix	62	14HI	4fsc(Skew)CLK POLARITY	0			
Fix	63	14HD	4fscCLK(Skew)CLK DELAY ADJUST	0				

KV-32FS320 SERVICE DATA

Service Group	Fix/ Var	No.	Name	Description	Common Init Data	16:9 Init Data	YUV Init Data	Memory Stick Init Data
ASIC	Fix	63	14HD	4fscCLK(Skew)CLK DELAY ADJUST	1			
	Fix	64	DSI	8fscCLK POLARITY	1			
	Fix	65	DSD	8fscCLK DELAY ADJUST	0			
	Fix	66	ADCD	ADC CLK DELAY ADJUST	0			
	Fix	67	WSTH	WEAK_SIGNAL VTH	0			
	Fix	68	WSVA	WEAK SIGNAL VIDEO ATT	0			
	Fix	69	WSCA	WEAK SIGNAL CHROMA ATT	0			
	Fix	70	VREF	AD REFERNCE SELECT(VZ)	0			
	Fix	71	DCCK	AD REFERNCE SELECT(VZ)	0		12	12
	Fix	72	HT	HALF TONE LEVEL	0			
	Fix	73	OSLR	R OSD LEVEL	27			
	Fix	74	OSLG	G OSD LEVEL	27			
	Fix	75	OSDC	OSD COMP	0			
	Fix	76	OSLB	B OSD LEVEL	27			
	Var	77	HRIL	H/W AKB RED OUTPUT Lower	*			
	Var	78	HRIH	H/W AKB RED OUTPUT Upper	*			
	Var	79	HGIL	H/W AKB GREEN OUTPUT Lower	*			
	Var	80	HGIH	H/W AKB GREEN OUTPUT Upper	*			
	Var	81	HBIL	H/W AKB BLUE OUTPUT Lower	*			
	Var	82	HBIH	H/W AKB BLUE OUTPUT Upper	*			
	Fix	83	HLM1	H/W AKB LIM1	4			
	Fix	84	HLM2	H/W AKB LIM2	12			
	Fix	85	HLM3	H/W AKB LIM3	21			
	Fix	86	HAD1	H/W AKB SPEED1	2			
	Fix	87	HAD2	H/W AKB SPEED2	6			
	Fix	88	HAKE	H/W AKB MANUAL (MCU)/HARD	1			
	Fix	89	HASP	H/W AKB SPEED	3			
	Fix	90	HERL	H/W AKB ERROR DET THRESH	10			
Fix	91	HLMC	H/W AKB ERROR DET TIME	15				
Fix	92	HPWL	H/W AKB POWER ON TRESH	4				
Fix	93	HPWC	H/W AKB POWER ON TIME	2				
Fix	94	HFMT	POWER ON H/W AKB2 HOLD TIMER(@100msec) [0 : No Hold]	20				
Fix	95	SPMT	AKB POWER ON MUTE EXIT TIMER(@100msec)	120				
Fix	96	GYG	G-Y Gain	0				
Fix	97	Y16M	YUV 16 M	1				
Fix	98	PCLP	Pedestal Clamp	0				

KV-32FS320 SERVICE DATA

Service Group	Fix/ Var	No.	Name	Description	Common Init Data
AUDIO	Fix	1	SBAL	Sub Balance	4
	Fix	2	SBAS	Sub Bass	0
	Fix	3	STRE	Sub Treble	0
	Fix	4	SRL	Surround Level	0
	Fix	5	BBOL	Surround Off-BBE Low	3
	Fix	6	BBOH	Surround Off-BBE High	3
	Fix	7	BBSL	Simulate BBE Low	3
	Fix	8	BBSH	Simulate BBE High	3
	Fix	9	BBGL	WOW Game BBE Low	5
	Fix	10	BBGH	WOW Game BBE High	5
	Fix	11	BBTL	SRS BBE Low	0
	Fix	12	BBTH	SRS BBE High	0
	Fix	13	VFIX	Audio output fix data	240
	Fix	14	AGCL	AGC level	2
	Fix	15	VCOF	VCOF	9

Service Group	Fix/ Var	No.	Name	Description	Common Init Data
MICRO	Var	1	DISP	OSD horizontal offset	93
	Fix	2	CCHP	for TILT data calculation	110
	Fix	3	HRLW	Low limit of H-pulse counting window (RF)	16
	Fix	4	HRHG	High limit of H-pulse counting window (RF)	64
	Fix	5	HSDT	H-pulse Detection(S-Video)	8
	Fix	6	STPI	Gradual CONTRAST Increase Starting level	40
	Fix	7	RAPI	Gradual CONTRAST Increase Vsync counter	10
	Fix	8	ZCRD	Zero Cross Relay Delay	20
	Fix	9	ABLT	ABL protection counter	3

Service Group	Fix/ Var	No.	Name	Description	Common Init Data
MS	FIX	1	VERS	M.S. Software Version	=

KV-36FS320 SERVICE DATA

Service Group	Fix/ Var	No.	Name	Description	Common Init Data
VERSION	Fix	0	VER	Microprocessor version information	=

= Means same as other register
 * Means change when tv turn on

Service Group	Fix/ Var	No.	Name	Description	Common Init Data	RF Init Data	Composite V Init Data
DEF	Var	1	HSIZ	H SIZE(EW DC)	41	36	36
	Var	2	HPOS	H POSITION	15	14	14
	Var	3	VSIZ	V RAMP SIZE	28	26	26
	Var	4	VPOS	V POSITION(RAMP DC)	31	32	32
	Var	5	VLIN	V LINEARITY	37		
	Var	6	SCOR	S CORRECTION	39		
	Var	7	VBOW	BOW	26		
	Var	8	VANG	ANGLE	43		
	Var	9	TRAP	EW TRAPESIUM	28		
	Var	10	PAMP	EW PIN	36		
	Var	11	UPIN	UPPER PIN	29		
	Var	12	LPIN	LOWER PIN	30		
	Var	13	TROT	TROT	128		
	Var	14	HBLK	H BLK mode select	0		
	Fix	15	RBLK	HBLK rear timing	21	25	25
	Var	16	LBLK	HBLK front timing	56	51	55
	Fix	17	VBLK	V BLK width	3		
	Fix	18	HMSK	TOP VEND(when MACROVISION)prevent OFF	0		
	Fix	19	HDW	H PULSE WIDTH(25u/19u)	1		
	Fix	20	AFC	AFC GAIN	0		
	Fix	21	AFC1	AFC1 TIME CONSTANT	0	7	0
	Fix	22	AFCW	AFC1 PULL IN WIDE	1		
	Fix	23	CDMD	V DET WINDOW SW TIMING	1		
	Fix	24	HSS	SYNC SLICE LEVEL(H sepa)	0		
	Fix	25	VSS	SYNC SLICE LEVEL(V sepa)	3		
	Fix	26	SLUD	Auto Slice level UP/DOWN	0		
	Fix	27	JPSW	Jump SW	0		
	Fix	28	HOSC	H VCO fo offset ADJUST OFFSET	3		
	Fix	29	EHT	EHT	4		
	Fix	30	EHTG	EHT MODE	1		

KV-36FS320 SERVICE DATA

Service Group	Fix/ Var	No.	Name	Description	Common Init Data
16:9	Fix	1	VSIZ	V RAMP SIZE	36
	Fix	2	VPOS	V POSITION(RAMP DC)	34
	Fix	3	VLIN	V LINEARITY	26
	Fix	4	SCOR	S CORRECTION	28
	Fix	5	TRAP	EW TRAPESIUM	23
	Fix	6	PAMP	EW PIN	18
	Fix	7	UPIN	UPPER PIN	31
	Fix	8	LPIN	LOWER PIN	32
	Fix	9	ABLG	ABL GAIN	1
	Fix	10	SCON	SUB CONTRAST LEVEL	10
	Fix	11	VPW	Jump Pulse Width	1

Service Group	Fix/ Var	No.	Name	Description	Common Init Data	RF Init Data	Composite V Init Data	YUV Init Data	Memory Stick Init Data
VP1	Fix	1	RDRV	R DRIVE	84				
	Var	2	GDRV	G DRIVE when Color Temp. is "Cool" and "Neutral"	74			77	77
	Var	3	BDRV	B DRIVE when Color Temp. is "Cool" and "Neutral"	73			74	74
	Var	4	RCUT	Hardware AKB(R) CMP DATA	100				
	Var	5	GCUT	Hardware AKB(G) CMP DATA when Color Temp. is "Cool" and "Neutral"	70			73	73
	Var	6	BCUT	Hardware AKB(B) CMP DATA when Color Temp. is "Cool" and "Neutral"	56			54	54
	Var	7	SCON	SUB CONTRAST LEVEL	10				1
	Var	8	SHUE	SUB TINT(HUE)		10	7	7	7
	Var	9	SCOL	SUB COLOR LEVEL		9	10	26	26
	Var	10	SBRT	SUB BRIGHTNESS	17			23	23
	Fix	11	RON	R OUTPUT ON (0:R Output OFF 1:R Output ON)	1				
	Fix	12	GON	G OUTPUT ON (0:G Output OFF 1:G Output ON)	1				
	Fix	13	BON	B OUTPUT ON (0:B Output OFF 1:B Output ON)	1				
	Fix	14	BLLV	BLUE STRETCH(00:no <-> 11:deep) only Color Temp "Cool"	1				
	Fix	15	MTRX	MATRIX RATIO SELECT	1				

KV-36FS320 SERVICE DATA

Service Group	Fix/ Var	No.	Name	Description	Common Init Data	RF Init Data	Composite V Init Data	YUV Init Data	Memory Stick Init Data
VP1	Fix	16	AXIS	R-Y PHASE OFFSET	52				
	Fix	17	SSHO	SUB SHARPNESS GAIN(OVER) RF/VIDEO		3	2	2	3
	Fix	18	SSHP	SUB SHARPNESS GAIN(PRE) RF/VIDEO		11	11	13	13
	Fix	19	SHPF	SHRPNNESS fo(00:2 CLK <-> 11:5 CLK)		0	1	0	0
	Fix	20	SHCL	SHARPNESS CORING LEVEL	1				
	Fix	21	SHMX	SHARPNESS LIMITTER LEVEL	15				
	Fix	22	AKBD	AKB Self Diagnostic Counter(@1sec)	5				
	Fix	23	AKBS	AKB Switch (0 : AKB OFF 1 : H/W AKB ON)	1				
	Fix	24	REFP	AKB REFPLS timing ("0"Fix when 16:9On)	0				
	Fix	25	YNRC	YNR LIMITER LEVEL	15				
	Fix	26	BKON	BLACK STRETCH ON	1				
	Fix	27	BKRC	BLACK STRETCH DETECTOR TIME CONSTANT1	=				
	Fix	28	BKDP	BLACK STRETCH START POINT	=				
Fix	29	BKSP	BLACK STRETCH POINT	=					

KV-36FS320 SERVICE DATA

Service Group	Fix/ Var	No.	Name	Description	Common Init Data	RF Init Data	Composite V Init Data	YUV Init Data	Memory Stick Init Data
VP2	Fix	1	VMOF	VM LEVEL at "Off" Setting	2				
	Fix	2	VMLO	VM LEVEL at "Low" Setting	5				
	Fix	3	VMHI	VM LEVEL at "High" Setting	11				
	Fix	4	VMDL	VM DELAY		10	10	6	6
	Fix	5	VMPL	VM PORALITY	1				
	Fix	6	VMWD	VM WIDTH	0				
	Fix	7	VMCL	VM CORING LEVEL	0				
	Fix	8	VMMX	VM LIMITER LEVEL	15				
	Fix	9	CKLV	COLOR KILLER VTH	1				
	Fix	10	CKON	FORCE KILLER	0				
	Fix	11	ALFA	ADAPTIVE DET SENSITIVITY YC SEPA FORCE	2				
	Fix	12	YCMD	SELECT(00:ADAPTIVE 01:H 10:V 11:HV)	0				
	Fix	13	VACL	V APERTURE CORING LEVEL	0				
	Fix	14	VAGA	V APERTURE GAIN LEVEL	=				
	Fix	15	VAMX	V APERTURE LIMITER LEVEL	15				
	Fix	16	GAMM	GAMMA(00:no <-->11:deep)	=				
	Fix	17	YDLY	Y DELAY TIME	3				
	Fix	18	CDLY	C DELAY	2				
	Fix	19	YOFF	Y OUTPUT MUTE	0				
	Fix	20	BGPP	BGP(for C DECODER)TIMING	11				
	Fix	21	NRCH	NOISE DET VTH1	3				
	Fix	22	NRCL	NOISE DET VTH1	255				
	Fix	23	NRVL	NOISE DET VTH1	255				
	Fix	24	NRVH	NOISE DET VTH1	255				
	Fix	25	GDOF	G DRIVE OFFSET only Color Temp. "Warm"	18				
	Fix	26	BDOF	B DRIVE OFFSET only Color Temp. "Warm"	31				
	Fix	27	GCOF	GCUT CMP DATA OFFSET only Color Temp. "Warm"	2				
	Fix	28	BCOF	BCUT CMP DATA OFFSET only Color Temp. "Warm"	4				
	Fix	29	DCTV	DCTTRANSFER VTH	3				
	Fix	30	DCTG	DCTTRANSFER GAIN	=				

KV-36FS320 SERVICE DATA

Service Group	Fix/ Var	No.	Name	Description	Common Init Data
NR	Var	1	SCOL	SUB COLOR LEVEL for NR	8
	Fix	2	SHCL	SHARPNESS NOISE CORING LEVEL for NR	15
	Fix	3	SHMX	SHARPNESS LIMITER LEVEL for NR	7
	Fix	4	YNRC	YNR LIMITER LEVEL for NR	7
	Fix	5	VMHI	VM LEVEL at "High" Setting for NR	7
	Fix	6	VMCL	VM CORING LEVEL for NR	0
	Fix	7	VMMX	VM LIMITER LEVEL for NR	7
	Fix	8	VAGA	V APERTURE GAIN LEVEL for NR	0
	Fix	9	GAMM	GAMMA(00:no <-->11:deep) for NR	0
	Fix	10	YNRS	YNR ON for NR	1
	Fix	11	WSTH	WEAK_SIGNAL VTH for NR	7
	Fix	12	WSVA	WEAK SIGNAL VIDEO ATT for NR	0
	Fix	13	WSCA	WEAK SIGNAL CHROMA ATT for NR	5

Service Group	Fix/ Var	No.	Name	Description	VIVID Init Data	STANDARD Init Data	MOVIE Init Data	PRO Init Data
PALETTE	Fix	1	VPIC	Picture	63	50	37	31
	Fix	2	VBRI	Brightness	31	31	28	31
	Fix	3	VCOL	Color	32	31	31	31
	Fix	4	VHUE	Hue	31	31	31	31
	Fix	5	VSHA	Sharpness	35	37	34	31
	Fix	6	VVM	VM	2	1	1	0
	Fix	7	VTRI	Color Temp	0	1	2	1
	Fix	8	VAPA	Aperture G	7	4	3	0
	Fix	9	VGMA	Gamma	3	2	2	0
	Fix	10	VDCT	DCT LV	12	9	9	2
	Fix	11	BKDP	BLACK STRETCH DEPTH	2	2	1	1
	Fix	12	BKRC	BLACK ST TIME 1 & TIME 2	243	243	244	244
	Fix	13	BKSP	BLACK STRETCH POINT	3	1	1	1
	Fix	14	CONO	CONTRAST OFFSET for RF	1	0	0	0

KV-36FS320 SERVICE DATA

Service Group	Fix/ Var	No.	Name	Description	Common Init Data	16:9 Init Data	YUV Init Data	Memory Stick Init Data
ASIC	Fix	1	YNRS	YNR ON	0			
	Fix	2	CLPS	CLAMP CONTROL SW (0:CLAMP OFF 1:CLAMP AUTO 2:CLAMP ON)	1			
	Fix	3	VMG2	MODULATOR FEEDBACK GAIN CONTROL	1			
	Fix	4	CLPT	CLAMP AUTO ON KEEP TIMER COUNT (@100ms)	15			
	Fix	5	AASL	C DECODER TIME CONSTANT(32,16,8,1H)	2			
	Fix	6	BASL	ACC TIME CONSTANT	0			
	Fix	7	ACTH	ROM HYS	95			
	Fix	8	AVAV	AVE SEL AV	3			
	Fix	9	B2TH	B2COMP	0			
	Fix	10	AMUT	RGB POWER ON MUTE	0			
	Fix	11	PMUT	RGB MUTE(EXCEPT OSD)	1			
	Fix	12	CORL	R CUTOFF lower	0			
	Fix	13	CORH	R CUTOFF upper	1			
	Fix	14	COGL	G CUTOFF lower when Color Temp. is "Cool" and "Neutral"	0			
	Fix	15	COGH	G CUTOFF upper when Color Temp. is "Cool" and "Neutral"	1			
	Fix	16	COBL	B CUTOFF lower when Color Temp. is "Cool" and "Neutral"	0			
	Fix	17	COBH	B CUTOFF upper when Color Temp. is "Cool" and "Neutral"	1			
	Fix	18	ALSP	ACL SPEED	0			
	Fix	19	ALAS	ACL ATTACK SPEED	146			
	Fix	20	ABLG	ABL GAIN	4			
	Fix	21	AKBM	AKB MODE	0			
	Fix	22	AKBP	AKB PULSE HEIGHT	10			
	Fix	23	OSDL	OSD LIMMIT SELECT	0			
	Fix	24	UVG	UV OFFSET CANCELER ON	0			
	Var	25	UOFS	U IN OFFSET	32			27
	Var	26	VOFS	V IN OFFSET	32			31
	Fix	27	AALG	ANALOG ACL GAIN CONTROL	0			
	Fix	28	AALS	ANALOG ACL ON/OFF CONTROL	1			
	Fix	29	UVDT	UVIN DITHER TEST	14			

KV-36FS320 SERVICE DATA

Service Group	Fix/ Var	No.	Name	Description	Common Init Data	16:9 Init Data	YUV Init Data	Memory Stick Init Data
ASIC	Fix	30	HFFR	AFC1 FORCE FREERUN	0			
	Fix	31	HFUP	H FREERUN FREQUENCY UP(700Hz)	0			
	Fix	32	JSWW	Jump Pulse Width	0			
	Fix	33	XF0A	VCXO FREERUN ADJUST	0			
	Fix	34	BGST	BGP(for PLL) TIMING	16		6	6
	Fix	35	XPHA	VCXO PHASE ADJUST	10			
	Fix	36	HRMP	AFC2 TIME CONSTANT	3			
	Fix	37	RPLU	REF PLL TIME CONSTANT	3			
	Fix	38	RPLB	REF PLL TIME CONSTANT	1			
	Fix	39	XF0B	VCXO Fo ADJUST	0			
	Fix	40	RPLS	REF VCO FB LOOP SELECT	0			
	Fix	41	SSM	SyncSepaMasking CONTROL	0			
	Fix	42	VSAG	V-SAG prevent ON	0			
	Fix	43	AFC2	AFC2 GAIN CONTROL	0			
	Fix	44	VRFL	V RAMP FILTER SWITCHING OFF	0			
	Fix	45	XPLU	ACP TIME CONSTANT	1			
	Fix	46	CDM2	V_LOGIC SW	1			
	Fix	47	BGPC	BGP C	0			
	Fix	48	MHDL	BGP SEL	1			
	Fix	49	BFRE	force V FREERUN	0			
	Fix	50	HRPP	FRAMP RRAMP H OUT CONTROL RANGE	2			
	Fix	51	DSCK	DS DAC CLK SW for only Not YUV	0	0		
	Fix	52	VBHK	V BLK HALF KILL only 16:9Off	0			
	Fix	53	VPW	V Pulse Wide	1			
	Fix	54	DTH	DITHER THRESHOLD LEVEL CONTROL at IIC AUTOD=ON	1			
	Fix	55	SLON	LPF SYNC ON	5		5	5
	Fix	56	VSSW	SYNC SLICE LEVEL(V) Wide Window	0			
	Fix	57	AF2S	AFC2 timing SW	0			
	Fix	58	VSL2	Digital V_SYNC_LPF(fall)	1			
	Fix	59	VSL1	Digital V_SYNC_LPF(rise)	0			
	Fix	60	VSHE	V-SHRINK MODE for AV-NoSync	0			
	Fix	61	DSCS	CLOCK DIV SEL	1		0	0
	Fix	62	14HI	4fsc(Skew)CLK POLARITY	0			
Fix	63	14HD	4fscCLK(Skew)CLK DELAY ADJUST	0				

KV-36FS320 SERVICE DATA

Service Group	Fix/ Var	No.	Name	Description	Common Init Data	16:9 Init Data	YUV Init Data	Memory Stick Init Data
ASIC	Fix	63	14HD	4fscCLK(Skew)CLK DELAY ADJUST	1			
	Fix	64	DSI	8fscCLK POLARITY	1			
	Fix	65	DSD	8fscCLK DELAY ADJUST	0			
	Fix	66	ADCD	ADC CLK DELAY ADJUST	0			
	Fix	67	WSTH	WEAK_SIGNAL VTH	0			
	Fix	68	WSVA	WEAK SIGNAL VIDEO ATT	0			
	Fix	69	WSCA	WEAK SIGNAL CHROMA ATT	0			
	Fix	70	VREF	AD REFERNCE SELECT(VZ)	0			
	Fix	71	DCCK	AD REFERNCE SELECT(VZ)	0		12	12
	Fix	72	HT	HALF TONE LEVEL	0			
	Fix	73	OSLR	R OSD LEVEL	27			
	Fix	74	OSLG	G OSD LEVEL	27			
	Fix	75	OSDC	OSD COMP	0			
	Fix	76	OSLB	B OSD LEVEL	27			
	Var	77	HRIL	H/W AKB RED OUTPUT Lower	*			
	Var	78	HRIH	H/W AKB RED OUTPUT Upper	*			
	Var	79	HGIL	H/W AKB GREEN OUTPUT Lower	*			
	Var	80	HGIH	H/W AKB GREEN OUTPUT Upper	*			
	Var	81	HBIL	H/W AKB BLUE OUTPUT Lower	*			
	Var	82	HBIH	H/W AKB BLUE OUTPUT Upper	*			
	Fix	83	HLM1	H/W AKB LIM1	4			
	Fix	84	HLM2	H/W AKB LIM2	12			
	Fix	85	HLM3	H/W AKB LIM3	21			
	Fix	86	HAD1	H/W AKB SPEED1	2			
	Fix	87	HAD2	H/W AKB SPEED2	6			
	Fix	88	HAKE	H/W AKB MANUAL (MCU)/HARD	1			
	Fix	89	HASP	H/W AKB SPEED	3			
	Fix	90	HERL	H/W AKB ERROR DET THRESH	10			
Fix	91	HLMC	H/W AKB ERROR DET TIME	15				
Fix	92	HPWL	H/W AKB POWER ON TRESH	4				
Fix	93	HPWC	H/W AKB POWER ON TIME	2				
Fix	94	HFMT	POWER ON H/W AKB2 HOLD TIMER(@100msec) [0 : No Hold]	20				
Fix	95	SPMT	AKB POWER ON MUTE EXIT TIMER(@100msec)	120				
Fix	96	GYG	G-Y Gain	0				
Fix	97	Y16M	YUV 16 M	1				
Fix	98	PCLP	Pedestal Clamp	0				

KV-36FS320 SERVICE DATA

Service Group	Fix/ Var	No.	Name	Description	Common Init Data
AUDIO	Fix	1	SBAL	Sub Balance	4
	Fix	2	SBAS	Sub Bass	0
	Fix	3	STRE	Sub Treble	0
	Fix	4	SRL	Surround Level	0
	Fix	5	BBOL	Surround Off-BBE Low	3
	Fix	6	BBOH	Surround Off-BBE High	3
	Fix	7	BBSL	Simulate BBE Low	3
	Fix	8	BBSH	Simulate BBE High	3
	Fix	9	BBGL	WOW Game BBE Low	5
	Fix	10	BBGH	WOW Game BBE High	5
	Fix	11	BBTL	SRS BBE Low	0
	Fix	12	BBTH	SRS BBE High	0
	Fix	13	VFIX	Audio output fix data	240
	Fix	14	AGCL	AGC level	2
	Fix	15	VCOF	VCOF	9

Service Group	Fix/ Var	No.	Name	Description	Common Init Data
MICRO	Var	1	DISP	OSD horizontal offset	93
	Fix	2	CCHP	for TILT data calculation	110
	Fix	3	HRLW	Low limit of H-pulse counting window (RF)	16
	Fix	4	HRHG	High limit of H-pulse counting window (RF)	64
	Fix	5	HSDT	H-pulse Detection(S-Video)	8
	Fix	6	STPI	Gradual CONTRAST Increase Starting level	40
	Fix	7	RAPI	Gradual CONTRAST Increase Vsync counter	10
	Fix	8	ZCRD	Zero Cross Relay Delay	20
	Fix	9	ABLT	ABL protection counter	3

Service Group	Fix/ Var	No.	Name	Description	Common Init Data
MS	FIX	1	VERS	M.S. Software Version	=

KV-32FS120/34FS120 SERVICE DATA

Service Group	Fix/Var	No.	Name	Description	Common Init Data
VERSION	Fix	0	VER	Microprocessor version information	=

= Means same as other register
 * Means change when tv turn on

Service Group	Fix/Var	No.	Name	Description	Common Init Data	RF Init Data	Composite V Init Data
DEF	Var	1	HSIZ	H SIZE(EW DC)	44	43	43
	Var	2	HPOS	H POSITION	24	27	28
	Var	3	VSIZ	V RAMP SIZE	29	27	27
	Var	4	VPOS	V POSITION(RAMP DC)	33	35	34
	Var	5	VLIN	V LINEARITY	37		
	Var	6	SCOR	S CORRECTION	45		
	Var	7	VBOW	BOW	36		
	Var	8	VANG	ANGLE	52		
	Var	9	TRAP	EW TRAPESIUM	22		
	Var	10	PAMP	EW PIN	31		
	Var	11	UPIN	UPPER PIN	30		
	Var	12	LPIN	LOWER PIN	31		
	Var	13	TROT	TROT	128		
	Var	14	HBLK	H BLK mode select	0		
	Fix	15	RBLK	HBLK rear timing	23	25	25
	Var	16	LBLK	HBLK front timing	56	53	53
	Fix	17	VBLK	V BLK width	3		
	Fix	18	HMSK	TOP VEND(when MACROVISION)prevent OFF	0		
	Fix	19	HDW	H PULSE WIDTH(25u/19u)	1		
	Fix	20	AFC	AFC GAIN	0		
	Fix	21	AFC1	AFC1 TIME CONSTANT	0	7	0
	Fix	22	AFCW	AFC1 PULL IN WIDE	1		
	Fix	23	CDMD	V DET WINDOW SW TIMING	1		
	Fix	24	HSS	SYNC SLICE LEVEL(H sepa)	0		
	Fix	25	VSS	SYNC SLICE LEVEL(V sepa)	3		
	Fix	26	SLUD	Auto Slice level UP/DOWN	0		
	Fix	27	JPSW	Jump SW	0		
	Fix	28	HOSC	H VCO fo offset ADJUST OFFSET	3		
	Fix	29	EHT	EHT	4		
	Fix	30	EHTG	EHT MODE	1		

KV-32FS120/34FS120 SERVICE DATA

Service Group	Fix/Var	No.	Name	Description	Common Init Data
16 : 9		1	VSIZ	V RAMP SIZE	35
		2	VPOS	V POSITION(RAMP DC)	39
		3	VLIN	V LINEARITY	30
		4	SCOR	S CORRECTION	14
		5	TRAP	EW TRAPESIUM	19
		6	PAMP	EW PIN	14
		7	UPIN	UPPER PIN	31
		8	LPIN	LOWER PIN	32
		9	ABLG	ABL GAIN	1
		10	SCON	SUB CONTRAST LEVEL	11
		11	VPW	Jump Pulse Width	1

Service Group	Fix/Var	No.	Name	Description	Common Init Data	RF Init Data	Composite V Init Data	YUV Init Data	Memory Stick Init Data
VP1		1	RDRV	R DRIVE	84				
		2	GDRV	G DRIVE when Color Temp. is "Cool" and "Neutral"	69			68	47
		3	BDRV	B DRIVE when Color Temp. is "Cool" and "Neutral"	69			67	62
		4	RCUT	Hardware AKB(R) CMP DATA	100				
		5	GCUT	Hardware AKB(G) CMP DATA when Color Temp. is "Cool" and "Neutral"	73			72	67
		6	BCUT	Hardware AKB(B) CMP DATA when Color Temp. is "Cool" and "Neutral"	64			58	49
		7	SCON	SUB CONTRAST LEVEL	11				23
		8	SHUE	SUB TINT(HUE)		9	7	8	10
		9	SCOL	SUB COLOR LEVEL		7	9	26	16
		10	SBRT	SUB BRIGHTNESS	15			22	16

KV-32FS120/34FS120 SERVICE DATA

Service Group	Fix/Var	No.	Name	Description	Common Init Data	RF Init Data	Composite V Init Data	YUV Init Data	Memory Stick Init Data
VP1		11	RON	R OUTPUT ON (0:R Output OFF 1:R Output ON)	1				
		12	GON	G OUTPUT ON (0:G Output OFF 1:G Output ON)	1				
		13	BON	B OUTPUT ON (0:B Output OFF 1:B Output ON)	1				
		14	BLLV	BLUE STRETCH(00:no <-> 11:deep) only Color Temp "Cool"	1				
		15	MTRX	MATRIX RATIO SELECT	1				
		16	AXIS	R-Y PHASE OFFSET	52				
		17	SSHO	SUB SHARPNESS GAIN(OVER) RF/VIDEO		3	2	2	12
		18	SSHP	SUB SHARPNESS GAIN(PRE) RF/VIDEO		11	11	13	18
		19	SHPF	SHRPNNESS fo(00:2 CLK <-> 11:5 CLK)		0	1	0	1
		20	SHCL	SHARPNESS CORING LEVEL	1				
		21	SHMX	SHARPNESS LIMITTER LEVEL	15				
		22	AKBD	AKB Self Diagnostic Counter(@1sec)	5				
		23	AKBS	AKB Switch (0 : AKB OFF 1 : H/W AKB ON)	1				
		24	REFP	AKB REFPLS timing ("0"Fix when 16:9On)	0				
		25	YNRC	YNR LIMITER LEVEL	15				
		26	BKON	BLACK STRETCH ON	1				
		27	BKRC	BLACK STRETCH DETECTOR TIME CONSTANT1	=				
		28	BKDP	BLACK STRETCH START POINT	=				
		29	BKSP	BLACK STRETCH POINT	=				

KV-32FS120/34FS120 SERVICE DATA

Service Group	Fix/Var	No.	Name	Description	Common Init Data	RF Init Data	Composite V Init Data	YUV Init Data	Memory Stick Init Data
VP2		1	VMOF	VM LEVEL at "Off" Setting	2				
		2	VMLO	VM LEVEL at "Low" Setting	5				
		3	VMHI	VM LEVEL at "High" Setting	11				
		4	VMDL	VM DELAY		10	10	6	6
		5	VMPL	VM PORALITY	1				
		6	VMWD	VM WIDTH	0				
		7	VMCL	VM CORING LEVEL	0				
		8	VMMX	VM LIMITER LEVEL	15				
		9	CKLV	COLOR KILLER VTH	1				
		10	CKON	FORCE KILLER	0				
		11	ALFA	ADAPTIVE DET SENSITIVITY YC SEPA FORCE	2				
		12	YCMD	SELECT(00:ADAPTIVE 01:H 10:V 11:HV)	0				
		13	VACL	V APERTURE CORING LEVEL	0				
		14	VAGA	V APERTURE GAIN LEVEL	=				
		15	VAMX	V APERTURE LIMITER LEVEL	15				
		16	GAMM	GAMMA(00:no <-->11:deep)	=				
		17	YDLY	Y DELAY TIME	3				
		18	CDLY	C DELAY	2				
		19	YOFF	Y OUTPUT MUTE	0				
		20	BGPP	BGP(for C DECODER)TIMING	11				
		21	NRCH	NOISE DET VTH1	3				
		22	NRCL	NOISE DET VTH1	255				
		23	NRVL	NOISE DET VTH1	255				
		24	NRVH	NOISE DET VTH1	255				
		25	GDOF	G DRIVE OFFSET only Color Temp. "Warm"	18				
		26	BDOF	B DRIVE OFFSET only Color Temp. "Warm"	31				
		27	GCOF	GCUT CMP DATA OFFSET only Color Temp. "Warm"	2				
		28	BCOF	BCUT CMP DATA OFFSET only Color Temp. "Warm"	4				
		29	DCTV	DCTTRANSFER VTH	3				
		30	DCTG	DCTTRANSFER GAIN	=				

KV-32FS120/34FS120 SERVICE DATA

Service Group	Fix/Var	No.	Name	Description	Common Init Data
NR		1	SCOL	SUB COLOR LEVEL for NR	7
		2	SHCL	SHARPNESS NOISE CORING LEVEL for NR	15
		3	SHMX	SHARPNESS LIMITER LEVEL for NR	7
		4	YNRC	YNR LIMITER LEVEL for NR	7
		5	VMHI	VM LEVEL at "High" Setting for NR	7
		6	VMCL	VM CORING LEVEL for NR	0
		7	VMMX	VM LIMITER LEVEL for NR	7
		8	VAGA	V APERTURE GAIN LEVEL for NR	0
		9	GAMM	GAMMA(00:no <-->11:deep) for NR	0
		10	YNRS	YNR ON for NR	1
		11	WSTH	WEAK_SIGNAL VTH for NR	7
		12	WSVA	WEAK SIGNAL VIDEO ATT for NR	0
		13	WSCA	WEAK SIGNAL CHROMA ATT for NR	5

Service Group	Fix/Var	No.	Name	Description	VIVID Init Data	STANDARD Init Data	MOVIE Init Data	PRO Init Data
PALETTE	Fix	1	VPIC	Picture	63	50	37	31
	Fix	2	VBRI	Brightness	31	31	28	31
	Fix	3	VCOL	Color	32	31	31	31
	Fix	4	VHUE	Hue	31	31	31	31
	Fix	5	VSHA	Sharpness	35	37	34	31
	Fix	6	VVM	VM	2	1	1	0
	Fix	7	VTRI	Color Temp	0	1	2	1
	Fix	8	VAPA	Aperture G	7	4	3	0
	Fix	9	VGMA	Gamma	3	2	2	0
	Fix	10	VDCT	DCT LV	12	9	9	2
	Fix	11	BKDP	BLACK STRETCH DEPTH	2	2	1	1
	Fix	12	BKRC	BLACK ST TIME 1 & TIME 2	243	243	244	244
	Fix	13	BKSP	BLACK STRETCH POINT	3	1	1	1
	Fix	14	CONO	CONTRAST OFFSET for RF	1	0	0	0

KV-32FS120/34FS120 SERVICE DATA

Service Group	Fix/Var	No.	Name	Description	Common Init Data	16:9 Init Data	YUV Init Data	Memory Stick Init Data
ASIC	Fix	1	YNRS	YNR ON	0			
	Fix	2	CLPS	CLAMP CONTROL SW (0:CLAMP OFF 1:CLAMP AUTO 2:CLAMP ON)	1			
		3	VMG2	MODULATOR FEEDBACK GAIN CONTROL	1			
		4	CLPT	CLAMP AUTO ON KEEP TIMER COUNT (@100ms)	15			
		5	AASL	C DECODER TIME CONSTANT(32,16,8,1H)	2			
		6	BASL	ACC TIME CONSTANT	0			
		7	ACTH	ROM HYS	95			
		8	AVAV	AVE SEL AV	3			
		9	B2TH	B2COMP	0			
		10	AMUT	RGB POWER ON MUTE	0			
		11	PMUT	RGB MUTE(EXCEPT OSD)	1			
		12	CORL	R CUTOFF lower	0			
		13	CORH	R CUTOFF upper	1			
		14	COGL	G CUTOFF lower when Color Temp. is "Cool" and "Neutral"	0			
		15	COGH	G CUTOFF upper when Color Temp. is "Cool" and "Neutral"	1			
		16	COBL	B CUTOFF lower when Color Temp. is "Cool" and "Neutral"	0			
		17	COBH	B CUTOFF upper when Color Temp. is "Cool" and "Neutral"	1			
		18	ALSP	ACL SPEED	0			
		19	ALAS	ACL ATTACK SPEED	146			
		20	ABLG	ABL GAIN	4			
		21	AKBM	AKB MODE	0			
		22	AKBP	AKB PULSE HEIGHT	10			
		23	OSDL	OSD LIMMIT SELECT	0			
		24	UVG	UV OFFSET CANCELER ON	0			
		25	UOFS	U IN OFFSET	32			39
		26	VOFS	V IN OFFSET	32			35
		27	AALG	ANALOG ACL GAIN CONTROL	0			
		28	AALS	ANALOG ACL ON/OFF CONTROL	1			
		29	UVDT	UVIN DITHER TEST	14			

KV-32FS120/34FS120 SERVICE DATA

Service Group	Fix/Var	No.	Name	Description	Common Init Data	16:9 Init Data	YUV Init Data	Memory Stick Init Data
ASIC		30	HFFR	AFC1 FORCE FREERUN	0			
		31	HFUP	H FREERUN FREQUENCY UP(700Hz)	0			
		32	JSWW	Jump Pulse Width	0			
		33	XF0A	VCXO FREERUN ADJUST	0			
		34	BGST	BGP(for PLL) TIMING	16		6	16
		35	XPHA	VCXO PHASE ADJUST	10			
		36	HRMP	AFC2 TIME CONSTANT	3			
		37	RPLU	REF PLL TIME CONSTANT	3			
		38	RPLB	REF PLL TIME CONSTANT	1			
		39	XF0B	VCXO Fo ADJUST	0			
		40	RPLS	REF VCO FB LOOP SELECT	0			
		41	SSM	SyncSepaMasking CONTROL	0			
		42	VSAG	V-SAG prevent ON	0			
		43	AFC2	AFC2 GAIN CONTROL	0			
		44	VRFL	V RAMP FILTER SWITCHING OFF	0			
		45	XPLU	ACP TIME CONSTANT	1			
		46	CDM2	V_LOGIC SW	1			
		47	BGPC	BGP C	0			
		48	MHDL	BGP SEL	1			
		49	BFRE	force V FREERUN	0			
		50	HRPP	FRAMP RRAMP H OUT CONTROL RANGE	2			
		51	DSCK	DS DAC CLK SW for only Not YUV	0	0		
		52	VBHK	V BLK HALF KILL only 16:9Off	0			
		53	VPW	V Pulse Wide	1			
		54	DTH	DITHER THRESHOLD LEVEL CONTROL at IIC AUTOD=ON	1			
		55	SLON	LPF SYNC ON	5		5	5
		56	VSSW	SYNC SLICE LEVEL(V) Wide Window	0			
		57	AF2S	AFC2 timing SW	0			
		58	VSL2	Digital V_SYNC_LPF(fall)	1			
		59	VSL1	Digital V_SYNC_LPF(rise)	0			
		60	VSHE	V-SHRINK MODE for AV-NoSync	0			
		61	DSCS	CLOCK DIV SEL	1		0	0
		62	14HI	4fsc(Skew)CLK POLARITY	1			
	63	14HD	4fscCLK(Skew)CLK DELAY ADJUST	0				

KV-32FS120/34FS120 SERVICE DATA

Service Group	Fix/Var	No.	Name	Description	Common Init Data	16:9 Init Data	RF Init Data	Composite V Init Data
ASIC		64	DSI	8fscCLK POLARITY	1			
		65	DSD	8fscCLK DELAY ADJUST	0			
		66	ADCD	ADC CLK DELAY ADJUST	0			
		67	WSTH	WEAK_SIGNAL VTH	0			
		68	WSVA	WEAK SIGNAL VIDEO ATT	0			
		69	WSCA	WEAK SIGNAL CHROMA ATT	0			
		70	VREF	AD REFERNCE SELECT(VZ)	0			
		71	DCCK	AD REFERNCE SELECT(VZ)	0		12	12
		72	HT	HALF TONE LEVEL	0			
		73	OSLR	R OSD LEVEL	27			
		74	OSLG	G OSD LEVEL	27			
		75	OSDC	OSD COMP	0			
		76	OSLB	B OSD LEVEL	27			
		77	HRIL	H/W AKB RED OUTPUT Lower	4			
		78	HRIH	H/W AKB RED OUTPUT Upper	1			
		79	HGIL	H/W AKB GREEN OUTPUT Lower	15			
		80	HGIH	H/W AKB GREEN OUTPUT Upper	1			
		81	HBIL	H/W AKB BLUE OUTPUT Lower	231			
		82	HBIH	H/W AKB BLUE OUTPUT Upper	0			
		83	HLM1	H/W AKB LIM1	4			
		84	HLM2	H/W AKB LIM2	12			
		85	HLM3	H/W AKB LIM3	21			
		86	HAD1	H/W AKB SPEED1	2			
		87	HAD2	H/W AKB SPEED2	6			
		88	HAKE	H/W AKB MANUAL (MCU)/HARD	1			
		89	HASP	H/W AKB SPEED	3			
		90	HERL	H/W AKB ERROR DET THRESH	10			
		91	HLMC	H/W AKB ERROR DET TIME	15			
	92	HPWL	H/W AKB POWER ON TRESH	4				
	93	HPWC	H/W AKB POWER ON TIME	2				
	94	HFMT	POWER ON H/W AKB2 HOLD TIMER(@100msec) [0 : No Hold]	20				
	95	SPMT	AKB POWER ON MUTE EXIT TIMER(@100msec)	120				
	96	GYG	G-Y Gain	0				
	97	Y16M	YUV 16 M	1				
	98	PCLP	Pedestal Clamp	0				

KV-32FS120/34FS120 SERVICE DATA

Service Group	Fix/Var	No.	Name	Description	Common Init Data
AUDIO	Fix	1	SBAL	Sub Balance	4
	Fix	2	SBAS	Sub Bass	0
	Fix	3	STRE	Sub Treble	0
	Fix	4	SRL	Surround Level	0
	Fix	5	BBOL	Surround Off-BBE Low	3
	Fix	6	BBOH	Surround Off-BBE High	3
	Fix	7	BBSL	Simulate BBE Low	3
	Fix	8	BBSH	Simulate BBE High	3
	Fix	9	BBGL	WOW Game BBE Low	0
	Fix	10	BBGH	WOW Game BBE High	0
	Fix	11	BBTL	SRS BBE Low	3
	Fix	12	BBTH	SRS BBE High	3
	Fix	13	VFIX	Audio output fix data	240
	Fix	14	AGCL	AGC level	2
	Fix	15	VCOF	VCOF	9

Service Group	Fix/Var	No.	Name	Description	Common Init Data
MICRO	Var	1	DISP	OSD horizontal offset	101
	Fix	2	CCHP	for TILT data calculation	110
	Fix	3	HRLW	Low limit of H-pulse counting window (RF)	16
	Fix	4	HRHG	High limit of H-pulse counting window (RF)	64
	Fix	5	HSDT	H-pulse Detection(S-Video)	8
	Fix	6	STPI	Gradual CONTRAST Increase Starting level	40
	Fix	7	RAPI	Gradual CONTRAST Increase Vsync counter	10
	Fix	8	ZCRD	Zero Cross Relay Delay	20
	Fix	9	ABLT	ABL protection counter	3

Service Group	Fix/Var	No.	Name	Description	Common Init Data
MS	FIX	1	VERS	M.S. Software Version	=

KV-36FS120/38FS120 SERVICE DATA
(DATA NOT AVAILABLE)

4-5. ID MAP TABLE

Model	Destination	ID-O	ID-1	ID-2	ID-3	ID-4	ID-5	ID-6	ID-7
KV-27FS320	US	89	63	231	32	0	0	0	4
KV-27FS320	CND	89	63	231	48	0	0	0	4
KV-32FS120	US	89	15	199	32	8	0	0	4
KV-32FS120	CND	89	15	199	48	8	0	0	4
KV-32FS320	US	89	63	231	32	0	0	0	4
KV-32FS320	CND	89	63	231	48	0	0	0	4
KV-34FS120	L NORTH	81	15	199	128	16	0	32	68
KV-34FS120	L SOUTH	81	15	199	128	16	0	32	68
KV-36FS120	US	89	15	199	32	8	0	0	4
KV-36FS120	CND	89	15	199	48	8	0	0	4
KV-36FS120	HAWAII	89	15	199	32	8	0	0	4
KV-36FS320	US	89	63	231	32	0	0	0	4
KV-36FS320	CND	89	63	231	48	0	0	0	4
KV-36FS320	HAWAII	89	63	231	32	0	0	0	4
KV-38FS120	L NORTH	81	15	199	128	16	0	32	68

4-6. A BOARD ADJUSTMENTS

H. Frequency (Free Run) Check

1. Input a TV mode (RF) with no signal.
2. Connect a frequency counter to base of Q501 (TP-25 H. DRIVE) on the A Board.
3. Check H. Frequency for 15735 ± 200 Hz.

V. Frequency (Free Run) Check

1. Select video 1 with no signal input.
2. Set the conditions for a standard setting.
3. Connect the frequency counter to TP-27 (V OUT) or CN501 pin ⑥ (V DY+) and ground on the A Board.
4. Check that V. Frequency shows 60 ± 4 Hz.

Drive (SCON)

1. Input a color-bar signal and set the level to 75%.
2. Set in Pro mode + PICTURE MAX.
3. Activate the Service Adjustment Mode.
4. Set GON and BON items. Using **[3]** and **[6]** set each to the following values. Leave RON set to "1".

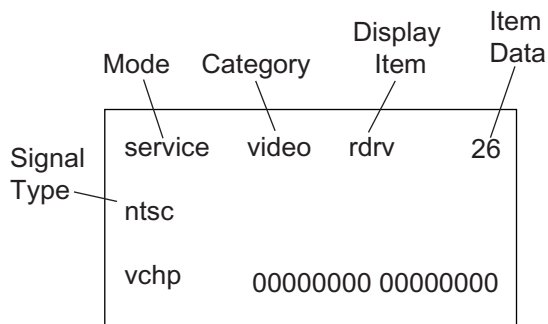

5. Connect an oscilloscope probe to C Board, CN705 pin3 (KR).
6. Select SCON with **[1]** and **[4]**.
7. Adjust the value of SCON with **[3]** and **[6]** for $92 \pm 2V_{pp}$.

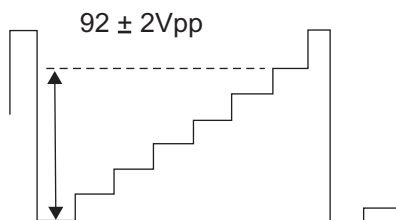

8. Reset GON and BON values to "1".

R ON:	ON	(1)
G ON:	ON	(1)
B ON:	ON	(1)

9. Press **[MUTING]** then **[ENTER]** to save into the memory.

Display Position Adjustment (DISP)

1. Input a color-bar signal.
2. Set to Service Adjustment Mode.
3. Select DISP with **[1]** and **[4]**.
4. Adjust values of DISP with **[3]** and **[6]** to adjust characters to the center.
5. Press **[MUTING]** then **[ENTER]** to save into the memory.
6. Check to see if the text is displayed on the screen.

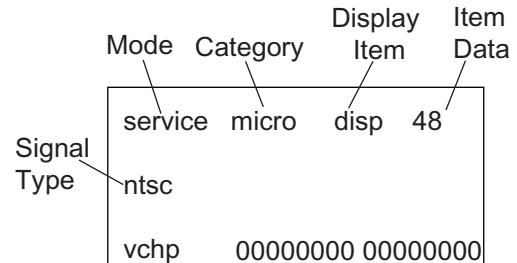

Sub Bright Adjustment (SBRT)

1. Input a monoscope signal.
2. Activate the Service Adjustment Mode.
3. Set the PICTURE and BRIGHTNESS to minimum.
4. Select the SBRT item with **[1]** and **[4]**.
5. Adjust the values of SBRT with **[3]** and **[6]** to obtain a faintly visible 20 IRE mark, after that increase +3 steps.
6. Press **[MUTING]** then **[ENTER]** to save into the memory.

Sub Hue, Sub Color Adjustment (SHUE, SCOL)

1. Input color-bar signal at 75%.
2. Activate the Service Adjustment Mode.
3. Set (PIC) to Max and (COL) to 50%.
4. Connect an oscilloscope probe to C Board, CN705 pin ④ (Blue Out).
5. Select the SHUE and SCOL item with **[1]** and **[4]**.
6. While showing the SHUE item, adjust the waveform with **[3]** and **[6]** until the second and third bars show the same level ($V_2 = V_3 < 0.15V_{p-p}$). Set Sub Hue -2 Step.
7. While showing the SCOL item, adjust the waveform with **[3]** and **[6]** until the first and fourth bars show the same level ($V_1 = V_4 < 0.15V_{p-p}$). Set Sub Col + 2 Step.

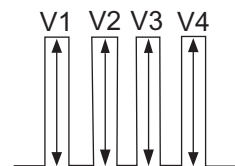

8. Press **[MUTING]** then **[ENTER]** to save into the memory.

V. Size Adjustment (VSIZ)

1. Input a crosshatch signal.
2. Activate the Service Adjustment Mode.
3. Select the VSIZ item with **1** and **4**.
4. Adjust value of VSIZ with **3** and **6** for the best vertical size.
5. Press **MUTING** then **ENTER** to save into the memory.

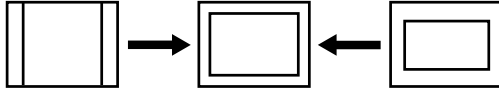

V. Center Adjustment (VPOS)

Perform this adjustment after performing H. Frequency (Free Run) Check.

1. Input a crosshatch signal.
2. Activate the Service Adjustment Mode.
3. Select the VPOS item with **1** and **4**.
4. Adjust value of VPOS with **3** and **6** for the best vertical center.
5. Press **MUTING** then **ENTER** to save into the memory.

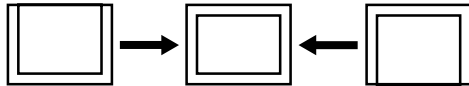

H. Center Adjustment (HPOS)

Perform this adjustment after performing H. Frequency (Free Run) Check.

1. Input a crosshatch signal.
2. Activate the Service Adjustment Mode.
3. Select the HPOS item with **1** and **4**.
4. Adjust the value of HPOS with **3** and **6** for the best horizontal center.
5. Press **MUTING** then **ENTER** to save into the memory.

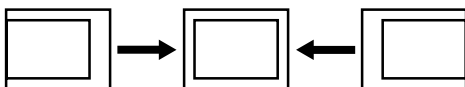

H. Size Adjustment (HSIZ)

1. Input a monoscope signal.
2. Activate the Service Adjustment Mode.
3. Select HSIZ with **1** and **4**.
4. Adjust with **3** and **6** for the best horizontal size.
5. Press **MUTING** then **ENTER** to save into the memory.

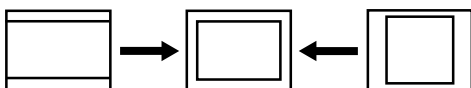

V. Linearity (VLIN), V. Correction (SCOR), PIN Amp (PAMP), and Horizontal Trapezoid (HTRP) Adjustments

1. Input a crosshatch signal.
2. Activate the Service Adjustment Mode.
3. Select VLIN, SCOR, PAMP, and HTRP with with **1** and **4**.
4. Adjust with **3** and **6** for the best horizontal size.
5. Press **MUTING** then **ENTER** to save into the memory.

V LINEARITY (VLIN)

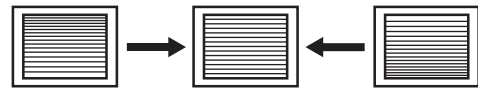

V CORRECTION (SCOR)

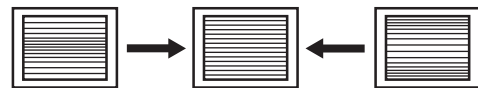

PIN AMP (PAMP)



HORIZONTAL TRAPEZOID (HTRP)

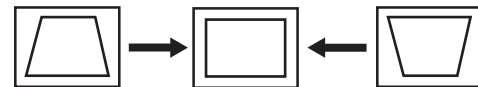

V. Angle (VANG), V. Bow (VBOW), Upper PIN (UPIN) and Low PIN (LPIN) Adjustments

1. Input a crosshatch signal.
2. Activate the Service Adjustment Mode.
3. Select VANG, VBOW, UPIN, and LPIN with **1** and **4**.
4. Adjust with **3** and **6** for the best picture.
5. Press **MUTING** then **ENTER** to save into the memory.

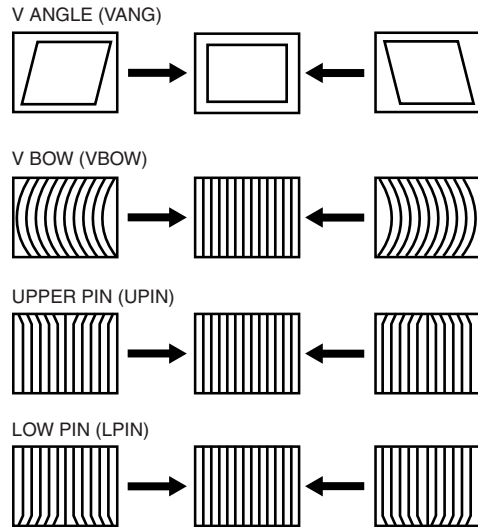



Service Adjustment Mode Memory

1. After completing all adjustments, press **0** then **ENTER**.

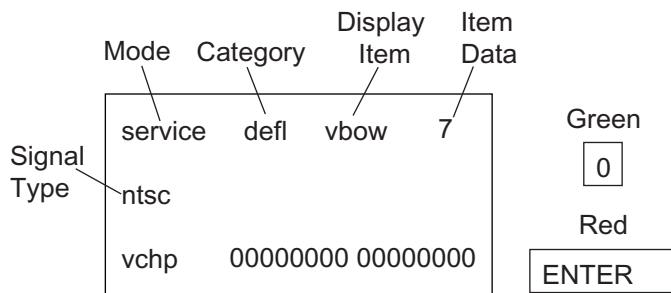
Read From Memory

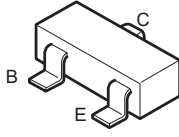
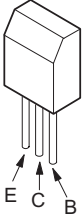
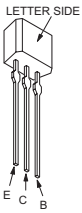
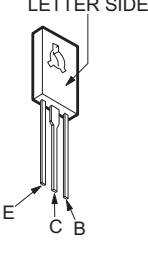
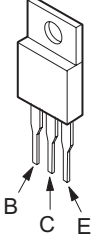

5-4. SEMICONDUCTORS

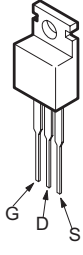
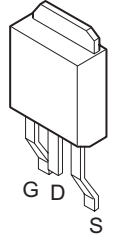
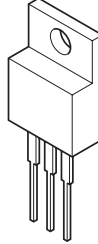
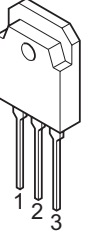
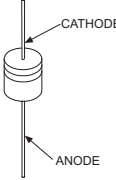
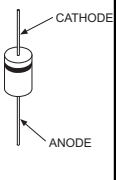
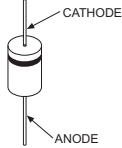
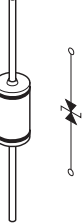
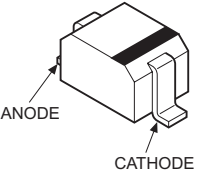
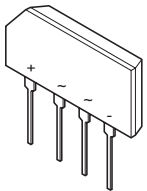
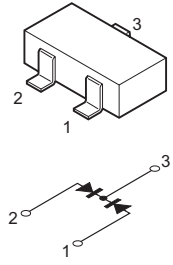
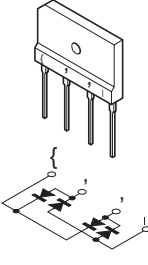
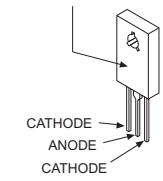
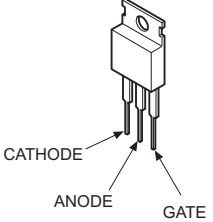
<p>2SB709A-QRS-TX 2SD601A-QRS-TX</p> 	<p>2SB734-T-34 2SC3209LK-TP</p> 	<p>2SA1309A-QRSTA 2SC3311A-QRSTA 2SD2144S-TP-UVW</p> 	<p>2SC3840K</p> 	<p>2SA1837</p> 
<p>2SA10910-TPE2</p> 	<p>IRF614</p> 	<p>2SK2663</p> 	<p>2SC4793</p> 	<p>2SD2578-YB</p> 
<p>ERA38-06TP1 ERA82-004TP5 1SS133T-77 D1NS0R-TA MTZJ-T-77-12C MTZJ-T-77-15B MTZJ-T-77-33B MTZJ-T-77-39</p> 	<p>RU-1P ERC06-15S EGP20DPKG23 MTZJ-T-77-5.1C MTZJ-T-77-5.6C MTZJ-T-77-7.5A MTZJ-T-77-10B MTZJ-T-77-30D RGP10-GPKG3 RGP02-17PKG23 RGP15GPKG23</p> 	<p>ERB44-06TP1 1SS83TD GP08DPKG23 RGP10GPKG23 RU4AM-T3</p> 	<p>RD9.1EW-T1</p> 	<p>MA111-TX UDZ-TE-17.5.1B UDZ-TE-17.91B</p> 
<p>D2SB60A-F04</p> 	<p>DAP202K-T-146</p> 	<p>D4SB60L-F</p> 		
<p>D5LC20U</p> 	<p>TF541M</p> 			

SECTION 6: EXPLODED VIEWS

Components not identified by a part number or description are not stocked because they are seldom required for routine service.

The component parts of an assembly are indicated by the reference numbers in the far right column of the parts list and within the dotted lines of the diagram.

* Items marked with an asterisk are not stocked since they are seldom required for routine service. Expect some delay when ordering these components.

NOTE: The components identified by shading and  mark are critical for safety. Replace only with part number specified.

NOTE: Les composants identifiés par un trame et une marque  sont critiques pour la sécurité. Ne les remplacer que par une pièce portant le numéro spécifié.

6-1. CHASSIS (KV-27FS320/32FS320/36FS320 ONLY)

▲	4-046-765-12	SCREW, TAPPING 7+CROWN WASHER
●	4-388-477-01	SCREW(3X16), TAPPING, +BV WASHER
□	7-685-648-79	SCREW +BVTP 3X12 TYPE2 TT(B)

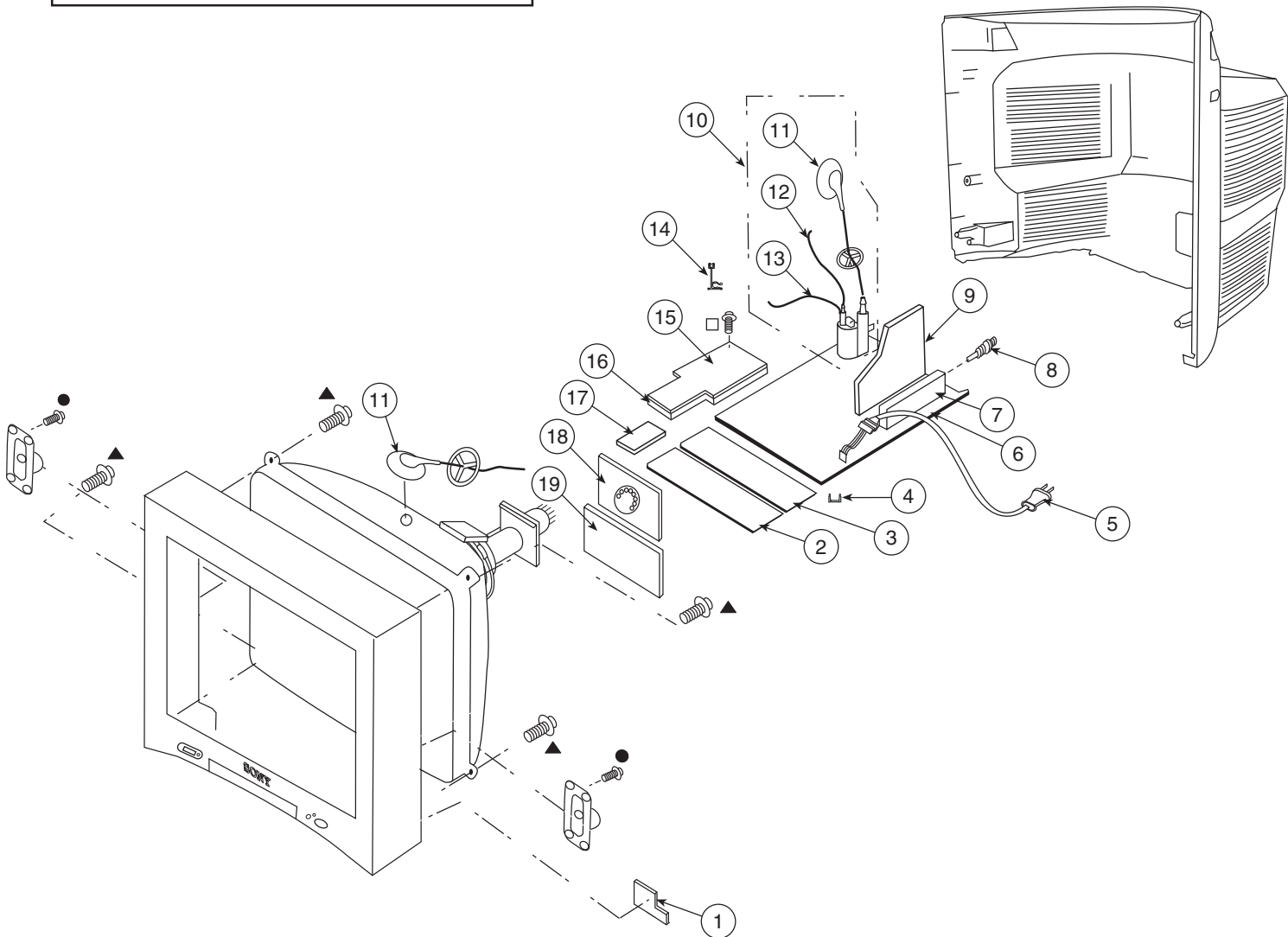

REF. NO.	PART NO.	DESCRIPTION	REF. NO.	PART NO.	DESCRIPTION	[ASSEMBLY INCLUDES]
* 1	A-1415-870-A	HR BOARD, MOUNTED	⚠ 10	1-453-310-11	FBT ASSY NX-4521//X4J4 (KV-27FS320 ONLY)	[11-13]
* 2	A-1415-872-A	HU BOARD, MOUNTED	⚠ 10	1-453-338-44	FBT ASSY NX-4600//X4C (KV-32FS320/36FS320 ONLY)	[11-13]
* 3	A-1415-873-A	HD BOARD, MOUNTED				
* 4	4-076-951-01	HINGE, PWB				
⚠ 5	1-824-069-11	CORD, AC POWER (WITH CONNECTOR)				
* 6	A-1057-457-A	A BOARD, COMPLETE (KV-27FS320 ONLY) The high-voltage leads associated with the FBT on the A board are not included and must be ordered separately. (See 11-13)	⚠ 11	1-251-715-22	CAP ASSY, HIGH-VOLTAGE	
* 6	A-1058-449-A	A BOARD, COMPLETE (KV-32FS320/36FS320 ONLY) The high-voltage leads associated with the FBT on the A board are not included and must be ordered separately. (See 11-13)	⚠ 12	1-900-800-82	WIRE ASSY, FOCUS	
			⚠ 13	1-900-803-22	WIRE ASSY, G2 LEAD	
			14	4-089-469-11	STANDOFF, HV (KV-36FS320 ONLY)	
			* 15	A-1056-114-A	HM BOARD, MOUNTED	
			* 16	4-102-416-01	BRACKET, HM	
			* 17	A-1054-787-A	HN BOARD, MOUNTED	
⚠ 7	8-598-593-50	TUNER, FSS BTF-WA421	* 18	A-1057-459-A	C (VAR) BOARD, MOUNTED (KV-27FS320 ONLY)	
⚠ 8	1-766-374-11	PLUG, F-PIN	* 18	A-1415-717-A	C (VAR) BOARD, MOUNTED (KV-32FS320/36FS320 ONLY)	
* 9	A-1057-456-A	M (VAR) BOARD, MOUNTED (KV-27FS320 ONLY)	* 19	A-1057-460-A	V (VAR) BOARD, MOUNTED (KV-27FS320 ONLY)	
* 9	A-1056-113-A	M (VAR) BOARD, MOUNTED (KV-32FS320 ONLY)	* 19	A-1415-719-A	V (VAR) BOARD, MOUNTED (KV-32FS320/36FS320 ONLY)	
* 9	A-1061-529-A	M (VAR) BOARD, MOUNTED (KV-36FS320 ONLY)				

NOTE: The components identified by shading and  mark are critical for safety. Replace only with part number specified.

NOTE: Les composants identifiés par un trame et une marque  sont critiques pour la sécurité. Ne les remplacer que par une pièce portant le numéro spécifié.

6-2. PICTURE TUBE (KV-27FS320/32FS320/36FS320 ONLY)

- | | | |
|---|--------------|----------------------------------|
| ▲ | 4-046-765-12 | SCREW, TAPPING 7+CROWN WASHER |
| ● | 4-388-477-01 | SCREW(3X16), TAPPING, +BV WASHER |
| ■ | 7-685-663-79 | SCREW +BVTP 4X16 TYPE2 TT(B) |

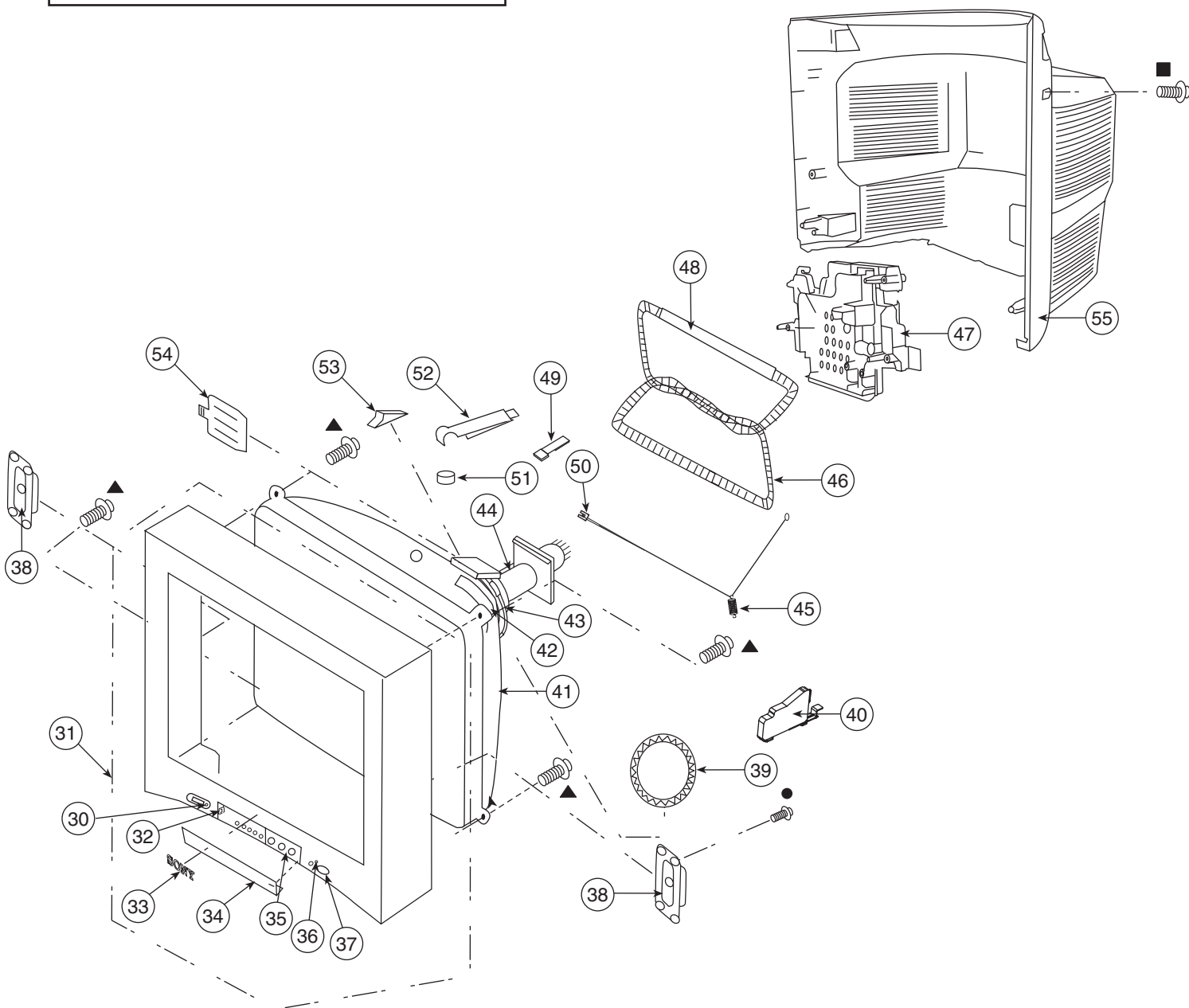

REF. NO.	PART NO.	DESCRIPTION	[ASSEMBLY INCLUDES]	REF. NO.	PART NO.	DESCRIPTION
30	4-102-420-01	GUIDE, LIGHT (MS)		45	4-082-641-01	SPRING, 45MM (KV-32FS320/36FS320 ONLY)
31	X-2021-481-1	BEZNET ASSY (KV-27FS320 ONLY)	[32-37]	△ 46	1-419-156-21	COIL, DEGAUSSING (KV-27FS320 ONLY)
31	X-2021-599-1	BEZNET ASSY (KV-32FS320 ONLY)	[32-37]	△ 46	1-428-988-31	DEGAUSSING COIL (31 INCH 120V) (KV-32FS320 ONLY)
31	X-2021-359-1	BEZNET ASSY (KV-36FS320 ONLY)	[32-37]	△ 46	1-456-011-21	COIL, DEGAUSSING (KV-36FS320 ONLY)
32	4-087-374-01	SPRING, DOOR		* 47	4-087-877-51	TERMINAL, BRACKET
33	4-046-160-41	EMBLEM, SONY NO.9		48	4-100-433-01	TUBE, DGC (A) (KV-32FS320 ONLY)
34	4-087-375-61	DOOR, CONTROL		48	4-098-344-01	TUBE, DGC (B) (KV-36FS320 ONLY)
35	4-087-376-21	LABEL, FRONT TERMINAL		49	4-083-414-01	PIECE A(110), CONV CORRECT (KV-27FS320/32FS320 ONLY)
36	4-087-156-01	GUIDE, LIGHT		49	4-085-128-01	PIECE A (100), CONV. CORRECT (KV-36FS320 ONLY)
37	4-087-150-41	BUTTON, POWER		50	4-082-640-01	HOOK, GROUND WIRE (KV-32FS320/36FS320 ONLY)
38	1-825-513-11	LOUDSPEAKER (6X12CM)		51	1-452-885-11	MAGNET, LANDING
△ 39	1-452-896-11	COIL, NA ROTATION (RT-200) (KV-27FS320/32FS320 ONLY)		* 52	4-062-970-12	CLIP (29RSN), DGC (KV-27FS320 ONLY)
△ 39	1-452-896-61	COIL, NA ROTATION (RT-200) (KV-36FS320 ONLY)		52	4-065-895-12	HOLDER, DGC (KV-32FS320 ONLY)
40	4-086-875-02	SUPPORTER, CRT (KV-36FS320 ONLY)		52	4-065-895-05	HOLDER, DGC (KV-36FS320 ONLY)
△ 41	8-735-082-05	CRT 29RSN(SDP) M68LNH050X (KV-27FS320 ONLY)		53	4-053-005-01	SPACER, DY (KV-27FS320/32FS320 ONLY)
△ 41	8-735-066-05	CRT 34RSN(SDP) A80LPD50X (KV-32FS320 ONLY)		53	2-164-116-01	SPACER, DY (KV-36FS320 ONLY)
△ 41	8-735-090-05	CRT 38RSN(FOR SOUTH CHINA) A90LPW80X (KV-36FS320 HAWAII ONLY)		54	4-081-170-01	PLATE, TLH CORRECTION (KV-27FS320/32FS320 ONLY)
△ 41	8-735-048-05	CRT 38RSN A90LPW80X (KV-36FS320 US & CND ONLY)		54	2-163-920-01	PLATE, TLH CORRECTION (KV-36FS320 ONLY)
42	4-088-879-01	CUSHION, 36 CRT SUPPORTER (KV-36FS320 ONLY)		55	4-087-777-05	COVER, REAR (KV-27FS320 ONLY)
△ 43	8-451-494-41	DY Y29RSA-V (KV-27FS320 ONLY)		55	4-087-878-04	COVER, REAR (KV-32FS320 ONLY)
△ 43	8-451-499-41	DY Y34RSA-V (KV-32FS320 ONLY)		55	4-086-697-04	COVER, REAR (KV-36FS320 ONLY)
△ 43	8-451-506-22	DY Y38RSA-V (KV-36FS320 ONLY)				
△ 44	8-453-011-11	NECK ASSEMBLY NA299-M (KV-27FS320 ONLY)				
△ 44	8-453-007-41	NECK ASSEMBLY NA324-M4 (KV-32FS320/36FS320 ONLY)				
45	4-036-329-01	SPRING (B), TENSION (KV-27FS320 ONLY)				

NOTE: The components identified by shading and  mark are critical for safety. Replace only with part number specified.

NOTE: Les composants identifiés par un trame et une marque  sont critiques pour la securite. Ne les remplacer que par une piece portant le numero specifie.

6-3. CHASSIS (KV-32FS120/34FS120/36FS120/38FS120 ONLY)

- | | |
|----------------|---------------------------------|
| ▲ 4-046-765-12 | SCREW, TAPPING 7+CROWN WASHER |
| ● 4-388-477-01 | SCREW(3X16), TAPPING,+BV WASHER |

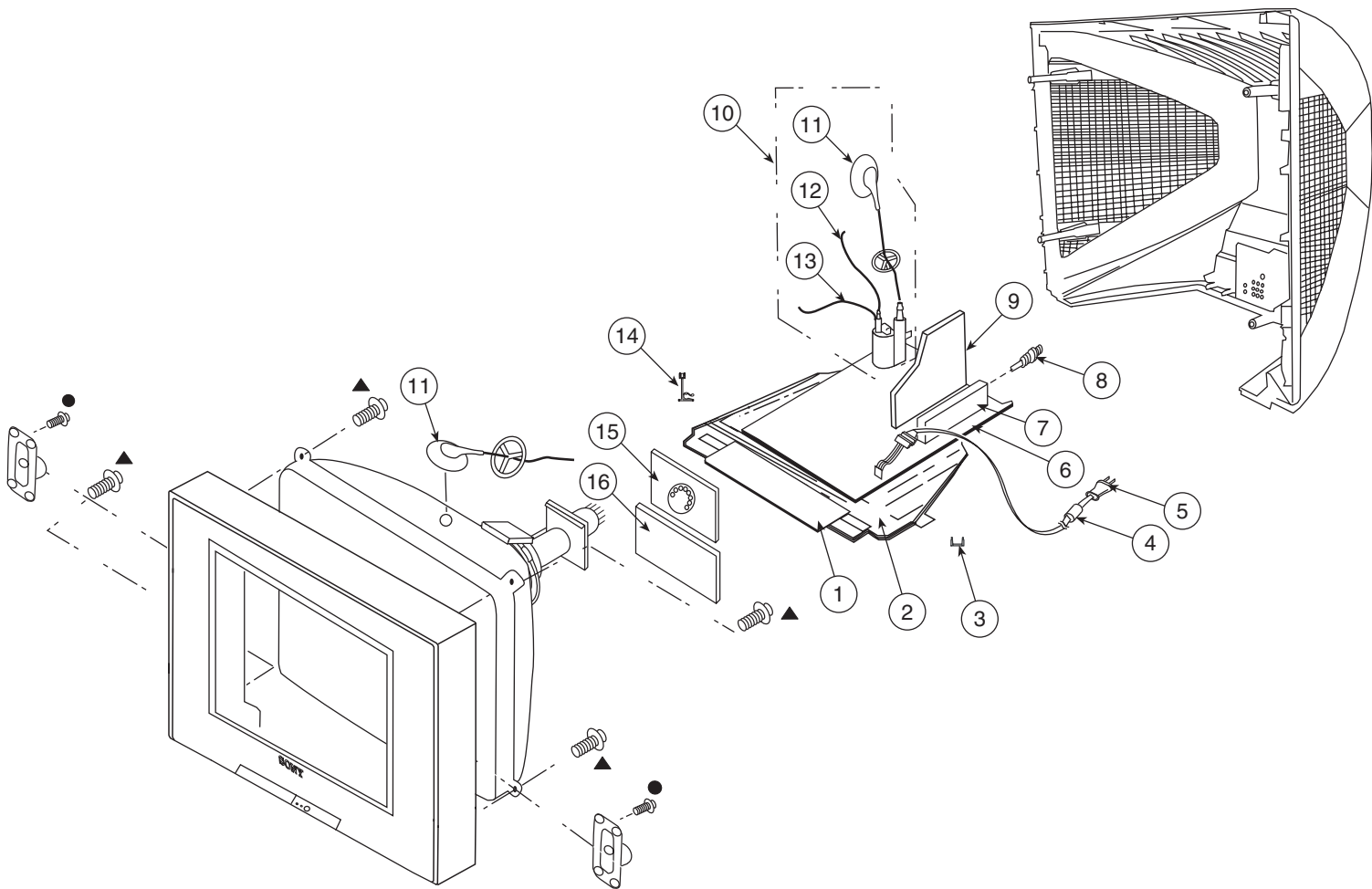

REF. NO.	PART NO.	DESCRIPTION	REF. NO.	PART NO.	DESCRIPTION	[ASSEMBLY INCLUDES]
* 1	A-1415-723-A	HS BOARD, MOUNTED	△ 7	8-598-593-50	TUNER, FSS BTF-WA421	
* 2	4-089-054-41	BOARD, BOTTOM	△ 8	1-766-374-11	PLUG, F-PIN	
* 3	4-076-951-01	HINGE, PWB	* 9	A-1415-721-A	M (VAR) BOARD, MOUNTED (KV-32FS120/34FS120 ONLY)	
4	1-500-586-11	FILTER, CLAMP (FERRITE CORE) (KV-34FS120 LATIN SOUTH ONLY)	* 9	A-1060-077-A	M (VAR) BOARD, MOUNTED (KV-36FS120/38FS120 ONLY)	
△ 5	1-824-069-11	CORD, AC POWER(WITH CONNECTOR) (ALL EXCEPT KV-34FS120 LATIN SOUTH)	△ 10	1-453-338-41	FBT ASSY NX-4600//X4J4	[11-13]
△ 5	1-757-840-13	CORD, POWER (WITH CONNECTOR) (KV-34FS120 LATIN SOUTH ONLY)	△ 11	1-251-715-22	CAP ASSY, HIGH-VOLTAGE	
* 6	A-1302-981-A	A BOARD, COMPLETE (ALL EXCEPT KV-34FS120 LATIN SOUTH) The high-voltage leads associated with the FBT on the A board are not included and must be ordered separately. (See 11-13)	△ 12	1-900-800-82	WIRE ASSY, FOCUS	
* 6	A-1056-321-A	A BOARD, COMPLETE (KV-34FS120 LATIN SOUTH ONLY) The high-voltage leads associated with the FBT on the A board are not included and must be ordered separately. (See 11-13)	△ 13	1-900-803-22	WIRE ASSY, G2 LEAD	
			14	4-089-469-11	STANDOFF, HV (KV-36FS120/38FS120 ONLY)	
			* 15	A-1415-717-A	C (VAR) BOARD, MOUNTED	
			* 16	A-1415-719-A	V (VAR) BOARD, MOUNTED	

NOTE: The components identified by shading and  mark are critical for safety. Replace only with part number specified.

NOTE: Les composants identifiés par un trame et une marque  sont critiques pour la sécurité. Ne les remplacer que par une pièce portant le numéro spécifié.

6-4. PICTURE TUBE (KV-32FS120/34FS120/36FS120/38FS120 ONLY)

- | | | |
|---|--------------|--------------------------------|
| ▲ | 4-046-765-12 | SCREW, TAPPING 7+CROWN WASHER |
| ● | 4-388-477-01 | SCREW(3X16),TAPPING,+BV WASHER |
| ■ | 7-685-663-79 | SCREW +BVTP 4X16 TYPE2 TT(B) |
| □ | 7-685-648-79 | SCREW +BVTP 3X12 TYPE2 TT(B) |

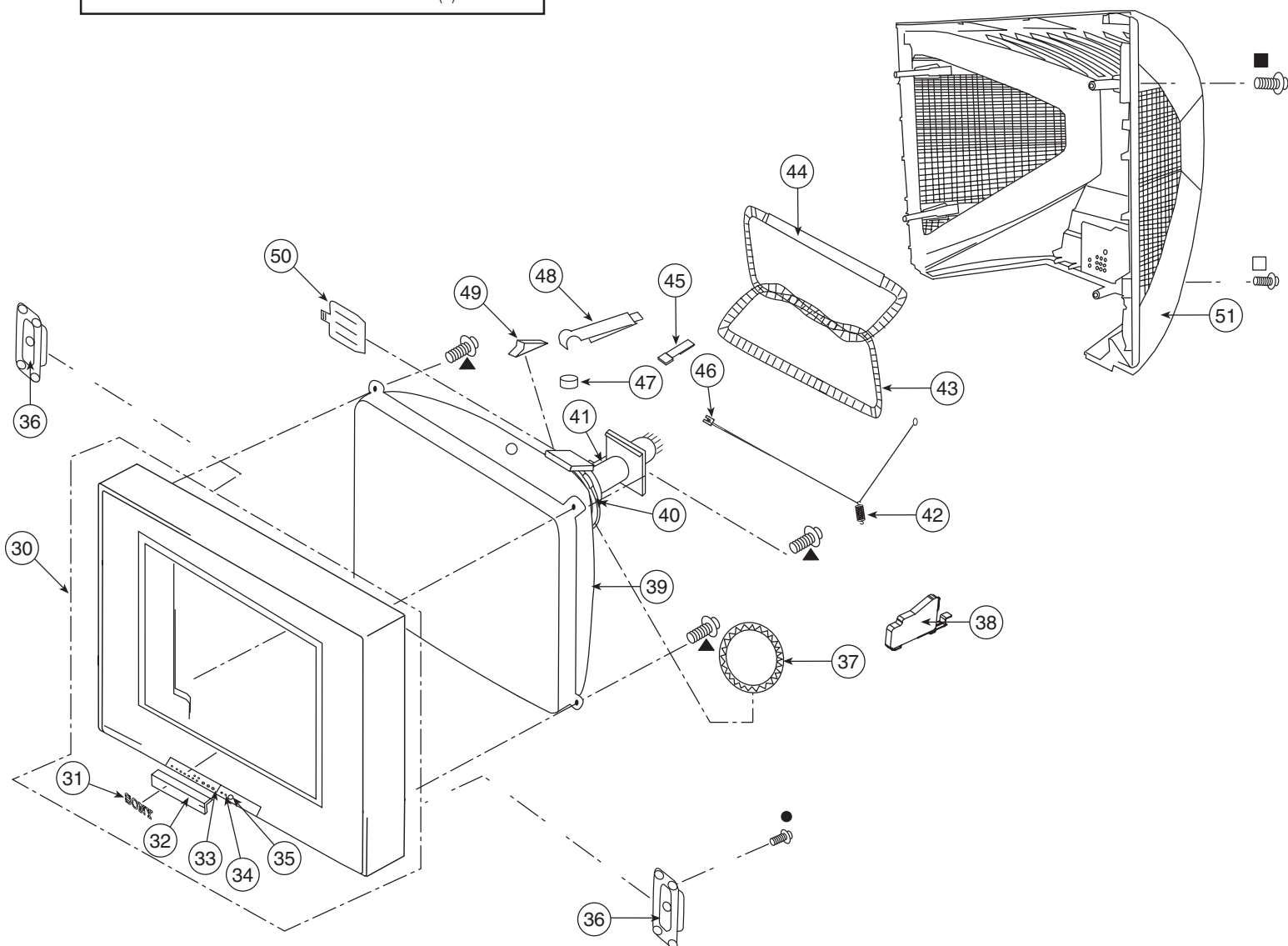

REF. NO.	PART NO.	DESCRIPTION	[ASSEMBLY INCLUDES]	REF. NO.	PART NO.	DESCRIPTION
30	X-2021-381-1	BEZNET ASSY (KV-32FS120/34FS120 ONLY)	[31-35]	42	4-082-641-01	SPRING, 45MM
30	X-2021-304-1	BEZNET ASSY (KV-36FS120/38FS120 ONLY)	[31-35]	* 42	4-083-303-01	SPRING, METAL
31	4-046-160-31	EMBLEM, SONY NO.9		△ 43	1-428-988-31	DEGAUSSING COIL (31 INCH 120V) (KV-32FS120 & KV-34FS120 LATIN NORTH ONLY)
32	4-089-056-11	DOOR (KV-32FS120/34FS120 ONLY)		△ 43	1-428-990-11	DEGAUSSING COIL (34 220V) (KV-34FS120 LATIN SOUTH ONLY)
32	4-089-056-21	DOOR (KV-36FS120/38FS120 ONLY)		△ 43	1-456-011-21	COIL, DEGAUSSING (KV-36FS120/38FS120 ONLY)
33	4-089-016-01	LABEL, DOOR		44	4-100-433-01	TUBE, DGC (A) (KV-32FS120/34FS120 ONLY)
34	4-089-058-01	GUIDE, LED		44	4-098-344-01	TUBE, DGC (B) (KV-36FS120/38FS120 ONLY)
35	4-089-057-11	BUTTON, POWER (KV-32FS120/34FS120 ONLY)		45	4-083-414-01	PIECE A(110), CONV CORRECT (KV-32FS120/34FS120 ONLY)
35	4-089-057-21	BUTTON, POWER (KV-36FS120/38FS120 ONLY)		45	4-085-128-01	PIECE A (100), CONV. CORRECT (KV-36FS120/38FS120 ONLY)
36	1-825-206-11	LOUDSPEAKER (6X12CM)		46	4-082-640-01	HOOK, GROUND WIRE
△ 37	1-452-896-11	COIL, NA ROTATION (RT-200) (KV-32FS120/34FS120 ONLY)		47	1-452-885-11	MAGNET, LANDING
△ 37	1-452-896-61	COIL, NA ROTATION (RT-200) (KV-36FS120/38FS120 ONLY)		48	4-065-895-12	HOLDER, DGC (KV-32FS120/34FS120 ONLY)
38	4-089-063-03	SUPPORTER, CRT (KV-32FS120/34FS120 ONLY)		48	4-065-895-05	HOLDER, DGC (KV-36FS120/38FS120 ONLY)
38	4-089-064-03	SUPPORTER, CRT (KV-36FS120/38FS120 ONLY)		49	4-053-005-01	SPACER, DY (KV-32FS120/34FS120 ONLY)
△ 39	8-735-066-05	CRT 34RSN(SDP) (A80LPD50X) (KV-32FS120 & KV-34FS120 LATIN NORTH ONLY)		49	2-164-116-01	SPACER, DY (KV-36FS120/38FS120 ONLY)
△ 39	8-735-050-05	CRT 34RSN(FOR EQUATORIAL AREA) (A80LPD80X) (KV-34FS120 LATIN SOUTH ONLY)		50	4-081-170-01	PLATE, TLH CORRECTION (KV-32FS120/34FS120 ONLY)
△ 39	8-735-090-05	CRT 38RSN(FOR SOUTH CHINA) (A90LPW80X) (KV-36FS120 HAWAII & KV-38FS120 LATIN NORTH ONLY)		50	2-163-920-01	PLATE, TLH CORRECTION (KV-36FS120/38FS120 ONLY)
△ 39	8-735-048-05	CRT 38RSN (A90LPW80X) (KV-36FS120 US & CND ONLY)		51	4-089-051-41	COVER, REAR (KV-32FS120/34FS120 ONLY)
△ 40	8-451-499-41	DY Y34RSA-V (KV-32FS120/34FS120 ONLY)		51	4-089-052-41	COVER, REAR (KV-36FS120/38FS120 ONLY)
△ 40	8-451-506-22	DY Y38RSA-V (KV-36FS120/38FS120 ONLY)				
△ 41	8-453-007-41	NECK ASSEMBLY NA324-M4				

SECTION 7: ELECTRICAL PARTS LIST

NOTE: The components identified by shading and \triangle mark are critical for safety. Replace only with part number specified.

NOTE: Les composants identifiés par un trame et une marque \triangle sont critiques pour la sécurité. Ne les remplacer que par une pièce portant le numéro spécifié.

The components in this manual identified by the following symbol: \boxtimes indicate parts that have been carefully factory-selected to satisfy regulations regarding X-ray radiation for each set.

Should replacement be required for one of these components, replace only with the value originally used.

* Items marked with an asterisk are not stocked since they are seldom required for routine service. Expect some delay when ordering these components.

RESISTORS

- All resistors are in ohms
- F : nonflammable
- All variable and adjustable resistors have characteristic curve B, unless otherwise noted.









When ordering parts by reference number, please include the board name.

REF. NO.	PART NO.	DESCRIPTION	VALUES	REF. NO.	PART NO.	DESCRIPTION	VALUES
A	* A-1057-457-A	A BOARD, COMPLETE (KV-27FS320 ONLY)		C203	1-107-826-11	CERAMIC CHIP	0.1 μ F 10% 16V
	* A-1302-981-A	A BOARD, COMPLETE (KV-32FS120/36FS120/38FS120 ONLY) (KV-34FS120 L. NORTH ONLY)		C206	1-107-826-11	CERAMIC CHIP	0.1 μ F 10% 16V
	* A-1056-321-A	A BOARD, COMPLETE (KV-34FS120 L. SOUTH ONLY)		C207	1-107-826-11	CERAMIC CHIP	0.1 μ F 10% 16V
	* A-1058-449-A	A BOARD, COMPLETE (KV-32FS320/36FS320 ONLY)		C208	1-107-826-11	CERAMIC CHIP	0.1 μ F 10% 16V
				C209	1-107-826-11	CERAMIC CHIP	0.1 μ F 10% 16V
		The high-voltage leads associated with the FBT on the A board are not included and must be ordered separately. Order the following leads when requesting this A Board:		C212	1-126-963-11	ELECT	4.7 μ F 20% 50V
\triangle	1-251-715-22	CAP ASSY, HIGH-VOLTAGE		C213	1-126-963-11	ELECT	4.7 μ F 20% 50V
\triangle	1-900-800-82	WIRE ASSY, FOCUS		C307	1-126-964-11	ELECT	10 μ F 20% 50V (KV-27FS320/32FS320/36FS320 ONLY)
\triangle	1-900-803-22	WIRE ASSY, G2 LEAD		C308	1-126-964-11	ELECT	10 μ F 20% 50V (KV-27FS320/32FS320/36FS320 ONLY)
*	4-374-846-11	COVER, CAPACITOR, CAP TYPE		C309	1-107-826-11	CERAMIC CHIP	0.1 μ F 10% 16V
	4-382-854-11	SCREW (M3X10), P, SW (+)		C310	1-126-964-11	ELECT	10 μ F 20% 50V (KV-27FS320/32FS320/36FS320 ONLY)
		CAPACITOR		C312	1-126-964-11	ELECT	10 μ F 20% 50V (KV-27FS320/32FS320/36FS320 ONLY)
C049	1-126-964-11	ELECT	10 μ F 20% 50V	C314	1-126-964-11	ELECT	10 μ F 20% 50V (KV-27FS320/32FS320/36FS320 ONLY)
C050	1-126-935-11	ELECT	470 μ F 20% 16V	C315	1-126-964-11	ELECT	10 μ F 20% 50V (KV-27FS320/32FS320/36FS320 ONLY)
C051	1-126-933-11	ELECT	100 μ F 20% 16V	C362	1-126-964-11	ELECT	10 μ F 20% 50V
C052	1-162-968-11	CERAMIC CHIP	0.0047 μ F 10% 50V	C365	1-162-117-00	CERAMIC	100pF 10% 500V
C053	1-107-826-11	CERAMIC CHIP	0.1 μ F 10% 16V	C366	1-126-964-11	ELECT	10 μ F 20% 50V
C054	1-126-967-11	ELECT	47 μ F 20% 50V	C367	1-107-826-11	CERAMIC CHIP	0.1 μ F 10% 16V
C055	1-126-933-11	ELECT	100 μ F 20% 16V	C368	1-126-964-11	ELECT	10 μ F 20% 50V
C056	1-135-834-91	CERAMIC CHIP	2.2 μ F 6.3V	C373	1-126-947-11	ELECT	47 μ F 20% 35V (KV-27FS320 ONLY)
C057	1-135-834-91	CERAMIC CHIP	2.2 μ F 6.3V	C373	1-104-665-11	ELECT	100 μ F 20% 25V (KV-32FS320/36FS320 ONLY)
C059	1-107-826-11	CERAMIC CHIP	0.1 μ F 10% 16V	C374	1-107-826-11	CERAMIC CHIP	0.1 μ F 10% 16V (KV-27FS320/32FS320/36FS320 ONLY)
C080	1-128-934-91	CERAMIC CHIP	0.33 μ F 20% 10V	C400	1-128-934-91	CERAMIC CHIP	0.33 μ F 20% 10V
C081	1-128-934-91	CERAMIC CHIP	0.33 μ F 20% 10V	C401	1-164-227-11	CERAMIC CHIP	0.022 μ F 10% 25V
C200	1-107-826-11	CERAMIC CHIP	0.1 μ F 10% 16V	C402	1-164-174-11	CERAMIC CHIP	0.0082 μ F 10% 25V
C201	1-107-826-11	CERAMIC CHIP	0.1 μ F 10% 16V	C403	1-162-967-11	CERAMIC CHIP	0.0033 μ F 10% 50V
C202	1-107-826-11	CERAMIC CHIP	0.1 μ F 10% 16V				

NOTE: The components identified by shading and  mark are critical for safety. Replace only with part number specified.

NOTE: Les composants identifiés par un trame et une  sont critiques pour la sécurité. Ne les remplacer que par une pièce portant le numéro spécifique.













REF. NO.	PART NO.	DESCRIPTION	VALUES	REF. NO.	PART NO.	DESCRIPTION	VALUES
C404	1-162-967-11	CERAMIC CHIP	0.0033μF 10% 50V	 C511	1-136-086-00	FILM	17000pF 3% 1.2KV
C405	1-164-677-11	CERAMIC CHIP	0.033μF 10% 16V		(KV-27FS320 ONLY)		
C406	1-164-677-11	CERAMIC CHIP	0.033μF 10% 16V	 C511	1-117-652-00	FILM	22000pF 3% 1.2KV
C407	1-115-412-11	CERAMIC CHIP	680pF 5% 25V		(ALL EXCEPT KV-27FS320)		
C408	1-115-412-11	CERAMIC CHIP	680pF 5% 25V	C512	1-164-315-11	CERAMIC CHIP	470pF 5% 50V
C409	1-125-891-11	CERAMIC CHIP	0.47μF 10% 10V	 C513	1-129-722-00	FILM	0.047μF 5% 630V
C410	1-125-891-11	CERAMIC CHIP	0.47μF 10% 10V		(KV-27FS320 ONLY)		
C411	1-128-934-91	CERAMIC CHIP	0.33μF 20% 10V	 C513	1-130-118-91	FILM	0.051μF 5% 400V
C412	1-126-961-11	ELECT	2.2μF 20% 50V		(ALL EXCEPT KV-27FS320)		
C413	1-126-960-11	ELECT	1μF 20% 50V	 C514	1-109-844-11	FILM	0.68μF 5% 400V
C414	1-126-960-11	ELECT	1μF 20% 50V		(KV-27FS320 ONLY)		
C415	1-126-960-11	ELECT	1μF 20% 50V	 C514	1-115-521-11	FILM	0.82μF 5% 250V
C416	1-126-960-11	ELECT	1μF 20% 50V		(ALL EXCEPT KV-27FS320)		
C417	1-115-416-11	CERAMIC CHIP	0.001μF 5% 25V	C515	1-104-987-11	MYLAR	0.001μF 5% 200V
C418	1-126-963-11	ELECT	4.7μF 20% 50V	 C516	1-115-521-11	FILM	0.82μF 5% 250V
C420	1-126-960-11	ELECT	1μF 20% 50V		(KV-27FS320 ONLY)		
C421	1-107-826-11	CERAMIC CHIP	0.1μF 10% 16V	 C516	1-115-356-11	FILM	1.2μF 5% 250V
		(KV-27FS320/32FS320/36FS320 ONLY)			(ALL EXCEPT KV-27FS320)		
C422	1-126-947-11	ELECT	47μF 20% 35V	C517	1-107-649-11	ELECT	2.2μF 20% 250V
C423	1-107-826-11	CERAMIC CHIP	0.1μF 10% 16V	C518	1-106-387-00	MYLAR	0.068μF 10% 200V
		(KV-27FS320/32FS320/36FS320 ONLY)		C519	1-102-244-00	CERAMIC	220pF 10% 500V
C450	1-100-120-51	ELECT	1000μF 20% 35V	C520	1-165-136-11	CERAMIC	3300pF 10% 500V
C451	1-137-194-81	FILM	0.47μF 5% 50V	C522	1-126-960-11	ELECT	1μF 20% 50V
C456	1-107-826-11	CERAMIC CHIP	0.1μF 10% 16V	C523	1-126-934-11	ELECT	220μF 20% 16V
C458	1-107-826-11	CERAMIC CHIP	0.1μF 10% 16V	C525	1-102-244-00	CERAMIC	220pF 10% 500V
C461	1-126-965-91	ELECT	22μF 20% 50V	C526	1-107-662-11	ELECT	22μF 20% 350V
C463	1-126-963-11	ELECT	4.7μF 20% 50V	 C527	1-162-116-00	CERAMIC	680pF 10% 2KV
C466	1-126-935-11	ELECT	470μF 20% 16V	C528	1-162-966-11	CERAMIC CHIP	0.0022μF 10% 50V
C467	1-126-935-11	ELECT	470μF 20% 16V	C529	1-104-662-91	ELECT	22μF 20% 25V
C468	1-126-935-11	ELECT	470μF 20% 16V	C530	1-164-690-91	CERAMIC CHIP	0.0022μF 5% 50V
C470	1-126-935-11	ELECT	470μF 20% 16V	C531	1-126-965-91	ELECT	22μF 20% 50V
C472	1-126-935-11	ELECT	470μF 20% 16V	C532	1-126-965-91	ELECT	22μF 20% 50V
C473	1-125-891-11	CERAMIC CHIP	0.47μF 10% 10V	C534	1-126-967-11	ELECT	47μF 20% 50V
C476	1-126-964-11	ELECT	10μF 20% 50V	C535	1-107-826-11	CERAMIC CHIP	0.1μF 10% 16V
C480	1-126-960-11	ELECT	1μF 20% 50V	C537	1-126-941-11	ELECT	470μF 20% 25V
C502	1-126-959-11	ELECT	0.47μF 20% 50V	C539	1-126-941-11	ELECT	470μF 20% 25V
C503	1-164-315-11	CERAMIC CHIP	470pF 5% 50V	C540	1-131-867-51	ELECT	100μF 160V
C504	1-102-228-00	CERAMIC	470pF 10% 500V	C541	1-128-560-11	ELECT	22μF 20% 100V
C505	1-102-228-00	CERAMIC	470pF 10% 500V	C545	1-106-387-00	MYLAR	0.068μF 10% 200V
C506	1-106-383-00	MYLAR	0.047μF 10% 200V	C546	1-104-987-11	MYLAR	0.001μF 5% 200V
 C507	1-162-116-00	CERAMIC	680pF 10% 2KV		(ALL EXCEPT KV-27FS320)		
 C509	1-162-116-00	CERAMIC	680pF 10% 2KV	C547	1-104-987-11	MYLAR	0.001μF 5% 200V
C510	1-137-150-11	FILM	0.01μF 5% 100V		(ALL EXCEPT KV-27FS320)		

NOTE: The components identified by shading and  mark are critical for safety. Replace only with part number specified.

NOTE: Les composants identifiés par un trame et une  sont critiques pour la sécurité. Ne les remplacer que par une pièce portant le numéro spécifique.







REF. NO.	PART NO.	DESCRIPTION	VALUES			REF. NO.	PART NO.	DESCRIPTION	VALUES			
	C553	1-117-412-11 FILM (KV-27FS320 ONLY)	0.24µF	5%	250V	C632	1-126-943-11	ELECT	2200µF	20%	25V	
	C553	1-117-661-11 FILM (ALL EXCEPT KV-27FS320)	0.15µF	5%	250V	C633	1-136-479-11	FILM	0.001µF	5%	100V	
	C554	1-117-629-11 FILM (KV-27FS320 ONLY)	2700pF	3%	1.2KV	C634	1-126-964-11	ELECT	10µF	20%	50V	
						C635	1-126-963-11	ELECT	4.7µF	20%	50V	
						C637	1-136-165-00	FILM	0.1µF	5%	50V	
						C638	1-126-943-11	ELECT	2200µF	20%	25V	
	C554	1-117-635-11 FILM (ALL EXCEPT KV-27FS320)	4700pF	3%	1.2KV	C642	1-126-969-11	ELECT	220µF	20%	50V	
	C561	1-126-967-11	ELECT	47µF	20%	50V	C643	1-136-165-00	FILM	0.1µF	5%	50V
	C563	1-104-666-11	ELECT	220µF	20%	25V	C645	1-162-964-11	CERAMIC CHIP	0.001µF	10%	50V
	C565	1-126-969-11	ELECT	220µF	20%	50V	C647	1-126-947-11	ELECT	47µF	20%	35V
	C568	1-137-190-91	FILM	0.22µF	5%	50V	C648	1-164-143-11	CERAMIC	0.001µF	10%	1KV
	C581	1-165-529-11	MYLAR	0.22µF	10	275V	C649	1-164-143-11	CERAMIC	0.001µF	10%	1KV
	C588	1-130-491-00	MYLAR	0.047µF	5%	50V	C650	1-100-120-51	ELECT	1000µF	20%	35V
	C590	1-126-964-11	ELECT	10µF	20%	50V	C651	1-126-942-61	ELECT	1000µF	20%	25V
	C600	1-117-703-11 MYLAR (KV-34FS120 L. SOUTH ONLY)	0.47µF	10	250V			(ALL EXCEPT KV-34FS120 L. SOUTH)				
						C651	1-126-943-61	ELECT	2200µF	20%	25V	
	C601	1-165-529-11	MYLAR	0.22µF	10	275V		(KV-34FS120 L. SOUTH ONLY)				
	C602	1-162-970-11	CERAMIC CHIP	0.01µF	10%	25V	C652	1-162-970-11	CERAMIC CHIP	0.01µF	10%	25V
	C603	1-165-529-11	MYLAR	0.22µF	10	275V	C653	1-126-964-11	ELECT	10µF	20%	50V
	C604	1-164-625-11	CERAMIC	680pF	10%	500V	C656	1-161-964-91	CERAMIC	0.0047µF		250V
	C608	1-119-912-51	CERAMIC	0.001µF	20%	125V	C658	1-161-964-91	CERAMIC	0.0047µF		250V
	C609	1-164-625-11	CERAMIC	680pF	10%	500V	C661	1-126-947-11	ELECT	47µF	20%	35V
	C612	1-104-665-11	ELECT	100µF	20%	25V	C669	1-164-625-11	CERAMIC	680pF	10%	500V
	C613	1-117-214-11 CERAMIC (KV-34FS120 L. SOUTH ONLY)	0.001µF	10%	2KV	C670	1-164-625-11	CERAMIC	680pF	10%	500V	
	C614	1-117-214-11 CERAMIC (KV-34FS120 L. SOUTH ONLY)	0.001µF	10%	2KV	C672	1-165-953-11	FILM	47000pF	3%	800V	
	C615	1-117-214-11 CERAMIC (KV-34FS120 L. SOUTH ONLY)	0.001µF	10%	2KV	C690	1-126-971-11	ELECT	470µF	20%	50V	
	C616	1-126-943-11	ELECT	2200µF	20%	25V	C1501	1-107-846-11	FILM	0.1µF	5%	400V
	C617	1-123-024-21	ELECT	33µF		160V		(ALL EXCEPT KV-27FS320)				
	C619	1-117-214-11 CERAMIC (KV-34FS120 L. SOUTH ONLY)	0.001µF	10%	2KV	CONNECTOR						
	C620	1-162-970-11	CERAMIC CHIP	0.01µF	10%	25V	CN202	1-695-915-11	TAB (CONTACT)			
	C621	1-100-961-11	ELECT	680µF	20%	250V		(KV-27FS320/32FS320/36FS320 ONLY)				
	C621	1-117-894-11	ELECT	560µF	20%	250V	*	CN401	1-564-507-11	PLUG, CONNECTOR	4P	
		(KV-32FS120/34FS120/36FS120/38FS120 ONLY)					*	CN501	1-580-798-11	CONNECTOR PIN (DY)	6P	
	C622	1-119-912-51	CERAMIC	0.001µF	20%	125V	*	CN503	1-564-510-11	PLUG, CONNECTOR	7P	
	C629	1-100-961-11	ELECT	680µF	20%	250V		CN505	1-785-879-11	CONNECTOR, ONE TOUCH		
		(KV-27FS320/32FS320/36FS320 ONLY)					*	CN508	1-573-963-11	PIN, CONNECTOR (PC BOARD)		
	C629	1-117-894-11	ELECT	560µF	20%	250V		CN600	1-580-843-11	PIN, CONNECTOR (POWER)		
		(KV-32FS120/34FS120/36FS120/38FS120 ONLY)						CN601	1-695-915-11	TAB (CONTACT)		
DIODE												
						D009	8-719-982-22	DIODE			MTZJ-30D	
						D200	8-719-069-60	DIODE			UDZSTE-179.1B	
						D201	8-719-069-60	DIODE			UDZSTE-179.1B	
						D209	8-719-069-60	DIODE			UDZSTE-179.1B	

NOTE: The components identified by shading and  mark are critical for safety. Replace only with part number specified.

NOTE: Les composants identifiés par un trame et une  sont critiques pour la sécurité. Ne les remplacer que par une pièce portant le numéro spécifique.











REF. NO.	PART NO.	DESCRIPTION	VALUES	REF. NO.	PART NO.	DESCRIPTION	VALUES
D210	8-719-069-60	DIODE	UDZSTE-179.1B	D501	8-719-404-50	DIODE	MA111-TX
D211	8-719-069-60	DIODE	UDZSTE-179.1B	 D503	8-719-081-00	DIODE	BY228/A52A/
D212	8-719-069-60	DIODE	UDZSTE-179.1B	D504	6-500-485-01	DIODE	FR305G-EB
D213	8-719-510-02	DIODE	D1NS4	D505	8-719-908-03	DIODE	GP08D
D218	8-719-929-15	DIODE	HZS9.1NB2	D506	8-719-908-03	DIODE	GP08D
D219	8-719-929-15	DIODE	HZS9.1NB2	D508	8-719-404-50	DIODE	MA111-TX
D305	8-719-070-62	DIODE	PDZ9.1B-115	D509	8-719-404-50	DIODE	MA111-TX
D306	8-719-070-62	DIODE	PDZ9.1B-115	 D515	8-719-075-41	DIODE	PR1004GT
D307	8-719-070-62	DIODE	PDZ9.1B-115	D516	8-719-404-50	DIODE	MA111-TX
D308	8-719-977-28	DIODE	DTZ10B	D518	8-719-404-50	DIODE	MA111-TX
D309	8-719-069-60	DIODE	UDZSTE-179.1B (ALL EXCEPT 27FS320/34FS120 L. SOUTH)	 D519	8-719-302-43	DIODE	EL1Z
D310	8-719-108-12	DIODE	RD9.1EW (KV-32FS120/34FS120/36FS120/38FS120 ONLY)	D520	8-719-404-50	DIODE	MA111-TX
D311	8-719-069-60	DIODE	UDZSTE-179.1B (ALL EXCEPT 27FS320/34FS120 L. SOUTH)	D521	8-719-921-63	DIODE	MTZJ-7.5B
D318	8-719-069-60	DIODE	UDZSTE-179.1B (KV-27FS320/32FS320/36FS320 ONLY)	D522	8-719-404-50	DIODE	MA111-TX
D319	8-719-069-60	DIODE	UDZSTE-179.1B (KV-27FS320/32FS320/36FS320 ONLY)	D525	8-719-404-50	DIODE	MA111-TX
D320	8-719-069-60	DIODE	UDZSTE-179.1B (KV-27FS320/32FS320/36FS320 ONLY)	D526	8-719-404-50	DIODE	MA111-TX
D321	8-719-069-60	DIODE	UDZSTE-179.1B (KV-27FS320/32FS320/36FS320 ONLY)	 D530	6-500-531-01	DIODE	PG154R
D322	8-719-069-60	DIODE	UDZSTE-179.1B (KV-27FS320/32FS320/36FS320 ONLY)	D531	6-500-531-01	DIODE	PG154R
D323	8-719-069-60	DIODE	UDZSTE-179.1B (KV-27FS320/32FS320/36FS320 ONLY)	D534	8-719-074-25	DIODE	PG104R
D324	8-719-069-60	DIODE	UDZSTE-179.1B (KV-32FS120/34FS120/36FS120/38FS120 ONLY)	D535	8-719-404-50	DIODE	MA111-TX
D325	8-719-069-60	DIODE	UDZSTE-179.1B (KV-32FS120/34FS120/36FS120/38FS120 ONLY)	D551	8-719-069-55	DIODE	UDZSTE-175.6B
D400	8-719-404-50	DIODE	MA111-TX	D561	8-719-075-33	DIODE	1N4003GA
D401	8-719-069-60	DIODE	UDZSTE-179.1B	D580	8-719-991-33	DIODE	1SS133T-77
D402	8-719-069-60	DIODE	UDZSTE-179.1B	D588	8-719-404-50	DIODE	MA111-TX
D405	8-719-404-50	DIODE	MA111-TX	D589	8-719-404-50	DIODE	MA111-TX
D414	8-719-921-63	DIODE	MTZJ-7.5B	D590	8-719-404-50	DIODE	MA111-TX
D418	1-216-864-11	SHORT CHIP		D600	8-719-510-53	DIODE	D4SB60L
D422	1-216-809-11	METAL CHIP	100 5% 1/10W	D602	8-719-064-12	DIODE	S1NB60-4062
D423	8-719-404-50	DIODE	MA111-TX	D611	8-719-062-40	DIODE	D4SBL20UF3
D424	8-719-404-50	DIODE	MA111-TX	D612	8-719-068-00	DIODE	ERC04-06SE
D425	8-719-056-84	DIODE	UDZ-TE-17-7.5B				(ALL EXCEPT KV-34FS120 L. SOUTH)
D500	8-719-081-00	DIODE	BY228/A52A/	D613	8-719-068-00	DIODE	ERC04-06SE
							(ALL EXCEPT KV-34FS120 L. SOUTH)
				D614	8-719-057-52	DIODE	EZ0150AV1
				D615	8-719-062-40	DIODE	D4SBL20UF3
				D618	8-719-979-64	DIODE	UF4005PKG23
				D620	8-719-404-50	DIODE	MA111-TX
				D621	6-500-181-01	DIODE	MA6D50
				D628	8-719-404-50	DIODE	MA111-TX
				D629	8-719-083-82	DIODE	UDZS-TE17-12B
				D631	6-500-567-01	DIODE	10ERB20-TA1B2
				D640	8-719-404-50	DIODE	MA111-TX
				D641	8-719-404-50	DIODE	MA111-TX
				D645	6-500-567-01	DIODE	10ERB20-TA1B2

NOTE: The components identified by shading and  mark are critical for safety. Replace only with part number specified.

NOTE: Les composants identifiés par un trame et une  sont critiques pour la sécurité. Ne les remplacer que par une pièce portant le numéro spécifique.







REF. NO.	PART NO.	DESCRIPTION	VALUES	REF. NO.	PART NO.	DESCRIPTION	VALUES
D646	8-719-404-50	DIODE	MA111-TX				
D647	6-500-567-01	DIODE	10ERB20-TA1B2				
D651	8-719-109-93	DIODE	RD6.2ESB2				
D690	8-719-982-13	DIODE	MTZJ-27				
FUSE				JACK			
	F601	1-576-193-11 FUSE (ALL EXCEPT KV-34FS120 L. SOUTH)	6.3A 125V	*	J201	1-818-351-11 S TERMINAL-PIN JACK BLOCK	
	F601	1-532-506-51 FUSE (KV-34FS120 L. SOUTH ONLY)	6.3A 250V	*	J205	1-818-012-11 PIN JACK BLOCK 10P (KV-27FS320/32FS320/36FS320 ONLY)	
FERRITE BEAD				CHIP CONDUCTOR			
FB501	1-412-911-11	FERRITE	0μH	JR1	1-216-864-11	SHORT CHIP	
FB502	1-412-911-11	FERRITE	0μH	JR3	1-216-864-11	SHORT CHIP	
FB503	1-412-911-11	FERRITE	0μH	JR4	1-216-864-11	SHORT CHIP	
FB505	1-412-911-11	FERRITE	0μH	JR9	1-216-864-11	SHORT CHIP	
FB602	1-412-911-11	FERRITE	0μH	JR10	1-216-864-11	SHORT CHIP	
FB604	1-412-911-11	FERRITE	0μH	JR16	1-216-864-11	SHORT CHIP	
FB613	1-410-397-21	FERRITE	1.1μH	JR332	1-216-864-11	SHORT CHIP (KV-32FS120/34FS120/36FS120/38FS120 ONLY)	
FB614	1-412-911-11	FERRITE	0μH	JR334	1-216-864-11	SHORT CHIP (KV-32FS120/34FS120/36FS120/38FS120 ONLY)	
FB616	1-412-911-11	FERRITE	0μH	JR335	1-216-864-11	SHORT CHIP (KV-32FS120/34FS120/36FS120/38FS120 ONLY)	
FB617	1-412-911-11	FERRITE	0μH	JR444	1-216-864-11	SHORT CHIP	
FB650	1-412-911-11	FERRITE	0μH	JR445	1-216-864-11	SHORT CHIP	
FB651	1-412-911-11	FERRITE	0μH	COIL			
FB652	1-412-911-11	FERRITE	0μH	L003	1-414-856-11	INDUCTOR	10μH
FB653	1-412-911-11	FERRITE	0μH	L004	1-414-857-11	INDUCTOR	100μH
FUSE HOLDER				L009	1-414-857-11	INDUCTOR	100μH
	FH1	1-533-223-11 FUSE HOLDER	0A 0V	L501	1-406-677-11	INDUCTOR	10MH
	FH2	1-533-223-11 FUSE HOLDER	0A 0V	L502	1-412-552-11	INDUCTOR	2.2MH
IC				L503	1-406-677-11	INDUCTOR	10MH
IC302	8-759-353-00	IC	NJM2534M(TE2)		L505	1-406-978-11	INDUCTOR 150μH (ALL EXCEPT KV-27FS320)
IC303	8-759-443-11	IC	NJM2283M-TE1		L505	1-419-714-11	INDUCTOR 100μH (KV-27FS320 ONLY)
IC400	6-703-190-01	IC	NJW1134AGK1-TE2	L511	1-409-955-31	INDUCTOR	8MH
IC401	6-705-054-01	IC	TDA8947J	L515	1-412-529-11	INDUCTOR	22μH
IC501	8-759-700-07	IC	NJM2903M	L517	1-412-552-11	INDUCTOR	2.2MH
	IC561	8-759-980-58 IC (KV-27FS320 ONLY)	TDA8172	L604	1-412-525-31	INDUCTOR	10μH
	IC561	8-759-696-71 IC (ALL EXCEPT KV-27FS320)	STV9379A	L605	1-412-911-11	FERRITE	0μH
IC600	6-705-810-01	IC	MCZ3001DB	L606	1-412-911-11	FERRITE	0μH
IC601	8-749-012-13	IC	DM-58	L608	1-412-529-11	INDUCTOR	22μH
IC609	8-759-653-07	IC	PQ09RD21	L609	1-412-529-11	INDUCTOR	22μH

NOTE: The components identified by shading and  mark are critical for safety. Replace only with part number specified.

NOTE: Les composants identifiés par un trame et une  sont critiques pour la sécurité. Ne les remplacer que par une pièce portant le numéro spécifique.













REF. NO.	PART NO.	DESCRIPTION	VALUES	REF. NO.	PART NO.	DESCRIPTION	VALUES
PHOTO COUPLER				RESISTOR			
	PH602	8-749-924-35	PHOTO COUPLER ON3171-R	R84	1-249-377-11	CARBON	0.47 5% 1/4W
IC LINK				R085	1-215-924-00	METAL OXIDE	15K 5% 3W
PS401	1-576-337-21	IC LINK	2.7A 50V	R086	1-216-839-11	METAL CHIP	33K 5% 1/10W
TRANSISTOR				R087	1-216-837-11	METAL CHIP	22K 5% 1/10W
Q005	8-729-422-27	TRANSISTOR	2SD601A-Q	R089	1-216-829-11	METAL CHIP	4.7K 5% 1/10W
Q300	8-729-424-02	TRANSISTOR	2SB709A-QRS-TX	R099	1-216-809-11	METAL CHIP	100 5% 1/10W
Q304	8-729-422-27	TRANSISTOR	2SD601A-Q	R107	1-216-809-11	METAL CHIP	100 5% 1/10W
Q401	8-729-422-27	TRANSISTOR	2SD601A-Q	R108	1-216-809-11	METAL CHIP	100 5% 1/10W
Q402	8-729-422-27	TRANSISTOR	2SD601A-Q	R202	1-216-813-11	METAL CHIP	220 5% 1/10W
Q403	8-729-422-27	TRANSISTOR	2SD601A-Q	R206	1-216-813-11	METAL CHIP	220 5% 1/10W
Q405	8-729-120-28	TRANSISTOR	2SC1623-L5L6	R207	1-216-845-11	METAL CHIP	100K 5% 1/10W
Q412	8-729-422-27	TRANSISTOR	2SD601A-Q	R208	1-216-813-11	METAL CHIP	220 5% 1/10W
Q466	8-729-424-02	TRANSISTOR	2SB709A-QRS-TX	R209	1-216-845-11	METAL CHIP	100K 5% 1/10W
Q467	8-729-424-02	TRANSISTOR	2SB709A-QRS-TX	R210	1-216-813-11	METAL CHIP	220 5% 1/10W
Q468	8-729-424-02	TRANSISTOR	2SB709A-QRS-TX	R217	1-216-845-11	METAL CHIP	100K 5% 1/10W
Q469	8-729-424-02	TRANSISTOR	2SB709A-QRS-TX	R218	1-216-845-11	METAL CHIP	100K 5% 1/10W
Q470	8-729-424-02	TRANSISTOR	2SB709A-QRS-TX	R219	1-216-813-11	METAL CHIP	220 5% 1/10W
Q471	8-729-422-27	TRANSISTOR	2SD601A-Q	R220	1-216-813-11	METAL CHIP	220 5% 1/10W
Q472	8-729-422-27	TRANSISTOR	2SD601A-Q	R222	1-216-845-11	METAL CHIP	100K 5% 1/10W
Q501	8-729-140-50	TRANSISTOR	2SC3209LK	R223	1-216-813-11	METAL CHIP	220 5% 1/10W
	Q502	6-550-107-01	TRANSISTOR 2SD2645-YB	R224	1-216-813-11	METAL CHIP	220 5% 1/10W
Q509	8-729-422-27	TRANSISTOR	2SD601A-Q	R225	1-216-845-11	METAL CHIP	100K 5% 1/10W
	Q511	8-729-422-27	TRANSISTOR 2SD601A-Q	R232	1-216-853-11	METAL CHIP	470K 5% 1/10W
	Q512	8-729-809-29	TRANSISTOR 2SC4159-E	R233	1-216-853-11	METAL CHIP	470K 5% 1/10W
Q530	8-729-422-27	TRANSISTOR	2SD601A-Q	R234	1-216-813-11	METAL CHIP	220 5% 1/10W
Q531	8-729-424-02	TRANSISTOR	2SB709A-QRS-TX	R235	1-216-813-11	METAL CHIP	220 5% 1/10W
Q532	6-550-362-01	TRANSISTOR	KTA1279	R301	1-216-809-11	METAL CHIP	100 5% 1/10W
Q561	8-729-422-27	TRANSISTOR	2SD601A-Q	R302	1-218-839-11	METAL CHIP	470 0.50% 1/10W
Q562	8-729-424-02	TRANSISTOR	2SB709A-QRS-TX	R303	1-218-841-11	METAL CHIP	560 0.50% 1/10W
Q564	8-729-422-27	TRANSISTOR	2SD601A-Q	R315	1-218-285-11	METAL CHIP	75 5% 1/10W
Q582	8-729-422-27	TRANSISTOR	2SD601A-Q	(KV-27FS320/32FS320/36FS320 ONLY)			
Q583	8-729-424-02	TRANSISTOR	2SB709A-QRS-TX	R316	1-218-285-11	METAL CHIP	75 5% 1/10W
Q600	8-729-052-32	TRANSISTOR	IRFIB7N50A-LF31	(KV-27FS320/32FS320/36FS320 ONLY)			
Q601	8-729-052-32	TRANSISTOR	IRFIB7N50A-LF31	R317	1-218-285-11	METAL CHIP	75 5% 1/10W
Q605	8-729-140-96	TRANSISTOR	2SD774-34	R328	1-216-833-11	METAL CHIP	10K 5% 1/10W
Q606	8-729-422-27	TRANSISTOR	2SD601A-Q	R334	1-216-809-11	METAL CHIP	100 5% 1/10W
Q608	8-729-922-37	TRANSISTOR	2SD2144S-UVW	R335	1-216-821-11	METAL CHIP	1K 5% 1/10W
Q611	6-550-409-01	TRANSISTOR	KSC2383-O	R359	1-216-833-11	METAL CHIP	10K 5% 1/10W
Q690	8-729-424-02	TRANSISTOR	2SB709A-QRS-TX	R367	1-216-864-11	SHORT CHIP	
Q691	8-729-026-39	TRANSISTOR	2SA933AS-QT	R369	1-216-864-11	SHORT CHIP	

NOTE: The components identified by shading and  mark are critical for safety. Replace only with part number specified.

A component identified by this  symbol indicates that it has been carefully factory-selected to satisfy regulations regarding X-ray radiation. Should replacement be required, replace only with the value originally used.















REF. NO.	PART NO.	DESCRIPTION	VALUES			REF. NO.	PART NO.	DESCRIPTION	VALUES		
R390	1-218-285-11	METAL CHIP	75	5%	1/10W	R482	1-216-833-11	METAL CHIP	10K	5%	1/10W
R391	1-218-285-11	METAL CHIP	75	5%	1/10W	R483	1-216-825-11	METAL CHIP	2.2K	5%	1/10W
R393	1-218-285-11	METAL CHIP	75	5%	1/10W	R484	1-249-429-11	CARBON	10K	5%	1/4W
R394	1-218-285-11	METAL CHIP	75	5%	1/10W	R485	1-216-809-11	METAL CHIP	100	5%	1/10W
R400	1-216-829-11	METAL CHIP	4.7K	5%	1/10W	R488	1-216-825-11	METAL CHIP	2.2K	5%	1/10W
R401	1-216-809-11	METAL CHIP	100	5%	1/10W	R500	1-216-813-11	METAL CHIP	220	5%	1/10W
R402	1-216-845-11	METAL CHIP (KV-27FS320/32FS320/36FS320 ONLY)	100K	5%	1/10W	R502	1-216-829-11	METAL CHIP	4.7K	5%	1/10W
R403	1-247-807-31	CARBON	100	5%	1/4W	R503	1-249-425-11	CARBON	4.7K	5%	1/4W
R404	1-216-845-11	METAL CHIP (KV-27FS320/32FS320/36FS320 ONLY)	100K	5%	1/10W	R504	1-243-608-71 (KV-27FS320 ONLY)	METAL OXIDE	1.5K	5%	3W
R405	1-216-825-11	METAL CHIP	2.2K	5%	1/10W	R504	1-215-915-21 (ALL EXCEPT KV-27FS320)	METAL OXIDE	470	5%	3W
R406	1-249-393-11	CARBON	10	5%	1/4W	R506	1-243-683-71	METAL OXIDE	47	5%	1W
R408	1-216-825-11	METAL CHIP	2.2K	5%	1/10W	R507	1-249-401-11	CARBON	47	5%	1/4W
R410	1-216-813-11	METAL CHIP (KV-27FS320/32FS320/36FS320 ONLY)	220	5%	1/10W	R508	1-216-833-11	METAL CHIP	10K	5%	1/10W
R411	1-249-393-11	CARBON	10	5%	1/4W	R509	1-260-328-11	CARBON	1K	5%	1/2W
R414	1-216-813-11	METAL CHIP (KV-27FS320/32FS320/36FS320 ONLY)	220	5%	1/10W	 R510	1-215-908-00	METAL OXIDE	33	5%	3W
R416	1-216-829-11	METAL CHIP	4.7K	5%	1/10W	R512	1-243-535-71	METAL OXIDE	220	5%	3W
R422	1-218-867-11	METAL CHIP	6.8K	0.50%	1/10W	R513	1-216-841-11	METAL CHIP	47K	5%	1/10W
R424	1-216-821-11	METAL CHIP	1K	5%	1/10W	R514	1-216-833-11	METAL CHIP	10K	5%	1/10W
R425	1-216-823-11	METAL CHIP	1.5K	5%	1/10W	R517	1-249-415-11	CARBON	680	5%	1/4W
R429	1-216-841-11	METAL CHIP	47K	5%	1/10W	R518	1-216-833-11	METAL CHIP	10K	5%	1/10W
R450	1-216-833-11	METAL CHIP	10K	5%	1/10W	R519	1-249-411-11	CARBON	330	5%	1/4W
R457	1-216-809-11	METAL CHIP	100	5%	1/10W	R520	1-243-531-71	METAL OXIDE	100	5%	3W
R458	1-216-809-11	METAL CHIP	100	5%	1/10W	R521	1-216-815-11 (KV-27FS320 ONLY)	METAL CHIP	330	5%	1/10W
R463	1-216-864-11	SHORT CHIP				R521	1-216-817-11 (ALL EXCEPT KV-27FS320)	METAL CHIP	470	5%	1/10W
R464	1-216-837-11	METAL CHIP	22K	5%	1/10W	 R523	1-216-837-11 (KV-27FS320 ONLY)	METAL CHIP	22K	5%	1/10W
R466	1-216-837-11	METAL CHIP	22K	5%	1/10W	 R523	1-216-834-11 (ALL EXCEPT KV-27FS320)	METAL CHIP	12K	5%	1/10W
R467	1-216-837-11	METAL CHIP	22K	5%	1/10W	 R524	1-216-833-11	METAL CHIP	10K	5%	1/10W
R468	1-216-837-11	METAL CHIP	22K	5%	1/10W	 R525	1-218-869-11	METAL CHIP	8.2K	0.50%	1/10W
R469	1-216-837-11	METAL CHIP	22K	5%	1/10W	 R528	1-218-879-11	METAL CHIP	22K	0.50%	1/10W
R470	1-216-837-11	METAL CHIP	22K	5%	1/10W	R529	1-218-879-11	METAL CHIP	22K	0.50%	1/10W
R471	1-216-837-11	METAL CHIP	22K	5%	1/10W	 R530	1-218-873-11	METAL CHIP	12K	0.50%	1/10W
R472	1-249-441-11	CARBON	100K	5%	1/4W	 R531	1-218-901-11 (KV-27FS320 ONLY)	METAL CHIP	180K	0.50%	1/10W
R473	1-216-837-11	METAL CHIP	22K	5%	1/10W	 R531	1-218-889-11 (ALL EXCEPT KV-27FS320)	METAL CHIP	56K	0.50%	1/10W
R474	1-216-837-11	METAL CHIP	22K	5%	1/10W	R532	1-216-810-11	METAL CHIP	120	5%	1/10W
R475	1-216-841-11	METAL CHIP	47K	5%	1/10W	R533	1-215-879-11	METAL OXIDE	47K	5%	1W
R477	1-216-819-11	METAL CHIP	680	5%	1/10W	R534	1-216-833-11	METAL CHIP	10K	5%	1/10W
R478	1-216-833-11	METAL CHIP	10K	5%	1/10W						
R479	1-216-821-11	METAL CHIP	1K	5%	1/10W						
R480	1-216-809-11	METAL CHIP	100	5%	1/10W						
R481	1-216-864-11	SHORT CHIP									

NOTE: The components identified by shading and  mark are critical for safety. Replace only with part number specified.

NOTE: Les composants identifiés par un trame et une  sont critiques pour la sécurité. Ne les remplacer que par une pièce portant le numéro spécifique.



















REF. NO.	PART NO.	DESCRIPTION	VALUES			REF. NO.	PART NO.	DESCRIPTION	VALUES		
R535	1-216-825-11	METAL CHIP	2.2K	5%	1/10W	R592	1-243-803-71	METAL OXIDE	0.33	5%	1W
 R536	1-260-288-11	CARBON	0.47	5%	1/2W	R593	1-249-417-11	CARBON	1K	5%	1/4W
 R537	1-260-288-11	CARBON	0.47	5%	1/2W			(KV-27FS320 ONLY)			
R538	1-247-887-00	CARBON	220K	5%	1/4W	R593	1-249-420-11	CARBON	1.8K	5%	1/4W
R541	1-216-841-11	METAL CHIP	47K	5%	1/10W			(ALL EXCEPT KV-27FS320)			
R542	1-216-833-11	METAL CHIP	10K	5%	1/10W	R594	1-249-429-11	CARBON	10K	5%	1/4W
 R543	1-249-377-11	CARBON	0.47	5%	1/4W	R595	1-247-891-00	CARBON	330K	5%	1/4W
R544	1-216-821-11	METAL CHIP	1K	5%	1/10W	R596	1-249-441-11	CARBON	100K	5%	1/4W
 R545	1-249-387-11	CARBON	3.3	5%	1/4W	R597	1-216-864-11	SHORT CHIP			
R546	1-215-453-00	METAL	22K	1%	1/4W	R598	1-218-867-11	METAL CHIP	6.8K	0.50%	1/10W
		(KV-27FS320 ONLY)									
R546	1-215-447-00	METAL	12K	1%	1/4W	R599	1-216-825-11	METAL CHIP	2.2K	5%	1/10W
		(ALL EXCEPT KV-27FS320)				R603	1-219-513-11	METAL	4.7M	5%	1/2W
R547	1-215-445-00	METAL	10K	1%	1/4W			(ALL EXCEPT KV-34FS120 L. SOUTH)			
R548	1-215-453-00	METAL	22K	1%	1/4W	R604	1-216-821-11	METAL CHIP	1K	5%	1/10W
R549	1-215-429-00	METAL	2.2K	1%	1/4W	R606	1-216-833-11	METAL CHIP	10K	5%	1/10W
 R550	1-249-377-11	CARBON	0.47	5%	1/4W	R607	1-216-833-11	METAL CHIP	10K	5%	1/10W
R551	1-215-873-00	METAL OXIDE	4.7K	5%	1W	R608	1-216-833-11	METAL CHIP	10K	5%	1/10W
R552	1-243-608-71	METAL OXIDE	1.5K	5%	3W	R609	1-216-389-11	METAL OXIDE	1	5%	3W
		(KV-27FS320 ONLY)				R610	1-216-833-11	METAL CHIP	10K	5%	1/10W
R552	1-215-915-21	METAL OXIDE	470	5%	3W	R611	1-216-833-11	METAL CHIP	10K	5%	1/10W
		(ALL EXCEPT KV-27FS320)									
 R553	1-249-377-11	CARBON	0.47	5%	1/4W	 R612	1-260-131-11	CARBON	470K	5%	1/2W
R559	1-216-805-11	METAL CHIP	47	5%	1/10W	R613	1-216-833-11	METAL CHIP	10K	5%	1/10W
R561	1-215-445-00	METAL	10K	1%	1/4W	 R615	1-202-933-61	FUSIBLE	0.1	10%	1/2W
 R563	1-214-798-21	METAL	1.8	1%	1/2W	R616	1-216-822-11	METAL CHIP	1.2K	5%	1/10W
R564	1-247-895-91	CARBON	470K	5%	1/4W	R617	1-216-821-11	METAL CHIP	1K	5%	1/10W
R565	1-215-889-00	METAL OXIDE	330	5%	2W	R618	1-216-864-11	SHORT CHIP			
R566	1-218-867-11	METAL CHIP	6.8K	0.50%	1/10W	R619	1-249-377-11	CARBON	0.47	5%	1/4W
 R567	1-249-385-11	CARBON	2.2	5%	1/4W	R620	1-215-857-11	METAL OXIDE	10	5%	1W
R568	1-218-867-11	METAL CHIP	6.8K	0.50%	1/10W	R625	1-216-817-11	METAL CHIP	470	5%	1/10W
R569	1-218-871-11	METAL CHIP	10K	0.50%	1/10W	R626	1-218-869-11	METAL CHIP	8.2K	0.50%	1/10W
R570	1-216-833-11	METAL CHIP	10K	5%	1/10W	R628	1-260-131-11	CARBON	470K	5%	1/2W
R571	1-216-833-11	METAL CHIP	10K	5%	1/10W	R629	1-245-478-21	METAL	470K	1%	1/4W
R572	1-216-833-11	METAL CHIP	10K	5%	1/10W	R630	1-245-478-21	METAL	470K	1%	1/4W
R573	1-216-837-11	METAL CHIP	22K	5%	1/10W	R631	1-218-875-11	METAL CHIP	15K	0.50%	1/10W
 R574	1-214-798-21	METAL	1.8	1%	1/2W	R632	1-218-823-11	METAL CHIP	100	0.50%	1/10W
R576	1-243-523-71	METAL OXIDE	22	5%	3W	R640	1-249-417-11	CARBON	1K	5%	1/4W
R580	1-216-845-11	METAL CHIP	100K	5%	1/10W	R641	1-216-389-11	METAL OXIDE	1	5%	3W
R583	1-216-829-11	METAL CHIP	4.7K	5%	1/10W	R647	1-211-992-11	METAL CHIP	91	0.50%	1/10W
R584	1-249-429-11	CARBON	10K	5%	1/4W	R648	1-216-864-11	SHORT CHIP			
R586	1-216-845-11	METAL CHIP	100K	5%	1/10W	R650	1-216-845-11	METAL CHIP	100K	5%	1/10W
R589	1-216-829-11	METAL CHIP	4.7K	5%	1/10W	R651	1-216-845-11	METAL CHIP	100K	5%	1/10W
R590	1-216-833-11	METAL CHIP	10K	5%	1/10W	R658	1-249-393-11	CARBON	10	5%	1/4W
						R659	1-249-393-11	CARBON	10	5%	1/4W
						R660	1-216-833-11	METAL CHIP	10K	5%	1/10W

NOTE: The components identified by shading and  mark are critical for safety. Replace only with part number specified.

NOTE: Les composants identifiés par un trame et une marque  sont critiques pour la sécurité. Ne les remplacer que par une pièce portant le numéro spécifique.





REF. NO.	PART NO.	DESCRIPTION	VALUES			REF. NO.	PART NO.	DESCRIPTION	VALUES		
R661	1-249-415-11	CARBON	680	5%	1/4W	 T604	1-437-606-12	CONVERTER TRANSFORMER			
R667	1-216-833-11	METAL CHIP	10K	5%	1/10W	 T605	1-443-402-11	TRANSFORMER, LINE FILTER			
R668	1-249-413-11	CARBON	470	5%	1/4W						
R670	1-216-833-11	METAL CHIP	10K	5%	1/10W						
R671	1-243-979-71	METAL OXIDE	0.1	5%	2W						
R672	1-243-979-71	METAL OXIDE	0.1	5%	2W						
 R674	1-220-926-11	FUSIBLE	0.47	10%	1/2W						
R681	1-216-825-11	METAL CHIP	2.2K	5%	1/10W						
R686	1-240-303-31	CEMENTED	0.22	5%	10W						
R687	1-220-797-11	CEMENTED	0.47	5%	10W						
R688	1-240-303-31	CEMENTED	0.22	5%	10W						
R691	1-216-837-11	METAL CHIP	22K	5%	1/10W						
R692	1-216-837-11	METAL CHIP	22K	5%	1/10W						
R694	1-216-837-11	METAL CHIP	22K	5%	1/10W						
R699	1-247-289-00	METAL OXIDE (KV-34FS120 L. SOUTH ONLY)	8.2M	5%	1W						
R932	1-218-285-11	METAL CHIP	75	5%	1/10W						
R934	1-218-285-11	METAL CHIP	75	5%	1/10W						
R953	1-218-285-11	METAL CHIP	75	5%	1/10W						
R1510	1-216-833-11	METAL CHIP	10K	5%	1/10W						
R1511	1-216-833-11	METAL CHIP	10K	5%	1/10W						
		RELAY									
RY501	1-755-198-11	RELAY, AC POWER									
 RY600	1-755-395-11	RELAY (AC POWER)									
		SWITCH									
S501	1-572-707-11	SWITCH, LEVER									
S502	1-572-707-11	SWITCH, LEVER									
		TRANSFORMER									
T501	1-433-836-11	TRANSFORMER, HORIZONTAL DRIVE									
 T502	1-435-869-11	TRANSFORMER, FERRITE (PMT)									
 T503	1-453-310-11	FBT ASSY NX-4521//X4J4 (KV-27FS320 ONLY)									
 T503	1-453-338-41	FBT ASSY NX-4600/X4J4 (ALL EXCEPT KV-27FS320)									
 T505	1-433-850-11	TRANSFORMER, HORIZONTAL LINEAR (KV-27FS320 ONLY)									
 T505	1-435-098-21	TRANSFORMER, HORIZONTAL LINEAR (ALL EXCEPT KV-27FS320)									
 T603	1-437-783-11	TRANSFORMER, STANDBY (ALL EXCEPT KV-34FS120 L. SOUTH)									
 T603	1-439-854-11	TRANSFORMER, STANDBY (KV-34FS120 L. SOUTH ONLY)									
						 T604	1-437-606-12	CONVERTER TRANSFORMER			
						 T605	1-443-402-11	TRANSFORMER, LINE FILTER			
								THERMISTOR			
						TH501	1-800-193-00	THERMISTOR			
						THP501	1-803-970-11	THERMISTOR, POSITIVE (ALL EXCEPT KV-34FS120 L. SOUTH)			
						THP501	1-803-540-11	THERMISTOR, POSITIVE (KV-34FS120 L. SOUTH ONLY)			
								TUNER			
						 TU001	8-598-593-50	TUNER, FSS BTF-WA421			
								VARISTOR			
						 VDR600	1-810-974-21	VARISTOR (ALL EXCEPT KV-34FS120 L. SOUTH)			
						 VDR600	1-804-995-11	VARISTOR (KV-34FS120 L. SOUTH ONLY)			
								CAPACITOR			
						C701	1-126-947-11	ELECT	47µF	20%	35V
						C702	1-136-497-81	FILM	0.1µF	5%	50V
						C703	1-126-947-11	ELECT	47µF	20%	35V
						C704	1-107-652-11	ELECT	10µF	20%	250V
						C705	1-107-652-11	ELECT	10µF	20%	250V
						C706	1-137-528-11	MYLAR	0.1µF	10%	250V
						C708	1-126-235-11	ELECT	100µF	20%	16V
						C709	1-126-964-11	ELECT	10µF	20%	50V
						C710	1-126-964-11	ELECT	10µF	20%	50V
						C711	1-102-074-00	CERAMIC	0.001µF	10%	50V
						C713	1-126-964-11	ELECT	10µF	20%	50V
						C714	1-126-947-11	ELECT	47µF	20%	35V
						C715	1-162-114-00	CERAMIC	0.0047µF		2KV
						C716	1-162-114-00	CERAMIC	0.0047µF		2KV
						C719	1-126-947-11	ELECT	47µF	20%	35V

C

* **A-1057-459-A C (VAR) BOARD, MOUNTED**
(KV-27FS320 ONLY)



* **A-1415-717-A C (VAR) BOARD, MOUNTED**
(ALL EXCEPT KV-27FS320)

 1-900-803-22 WIRE ASSY, G2 LEAD
4-382-854-11 SCREW (M3X10), P, SW (+)

NOTE: The components identified by shading and  mark are critical for safety. Replace only with part number specified.

NOTE: Les composants identifiés par un trame et une marque  sont critiques pour la sécurité. Ne les remplacer que par une pièce portant le numéro spécifique.



REF. NO.	PART NO.	DESCRIPTION	VALUES	REF. NO.	PART NO.	DESCRIPTION	VALUES
CONNECTOR							
* CN701	1-564-506-11	PLUG, CONNECTOR	3P	R710	1-247-807-31	CARBON	100 5% 1/4W
CN702	1-695-915-11	TAB (CONTACT)		R711	1-260-328-11	CARBON	1K 5% 1/2W
CN703	1-695-915-11	TAB (CONTACT)		R712	1-260-328-11	CARBON	1K 5% 1/2W
CN704	1-785-879-11	CONNECTOR, ONE TOUCH		R713	1-260-328-11	CARBON	1K 5% 1/2W
* CN705	1-564-511-11	PLUG, CONNECTOR	8P (KV-27FS320 ONLY)	R714	1-260-087-11	CARBON	100 5% 1/2W
* CN705	1-564-512-11	PLUG, CONNECTOR	8P (ALL EXCEPT KV-27FS320)	R715	1-260-132-11	CARBON	560K 5% 1/2W
* CN706	1-564-510-11	PLUG, CONNECTOR	7P	R716	1-260-087-11	CARBON	100 5% 1/2W
DIODE							
D701	8-719-901-83	DIODE	1SS83	R717	1-216-375-00	METAL OXIDE (KV-27FS320 ONLY)	3.3 5% 2W
D702	8-719-901-83	DIODE	1SS83	R718	1-216-373-11	METAL OXIDE	2.2 5% 2W
D703	8-719-901-83	DIODE	1SS83	R719	1-215-888-00	METAL OXIDE	220 5% 2W
D704	8-719-074-25	DIODE	PG104R	R720	1-216-825-11	METAL CHIP	2.2K 5% 1/10W
D705	8-719-108-12	DIODE	RD9.1EW	R721	1-216-825-11	METAL CHIP	2.2K 5% 1/10W
IC							
IC701	6-705-638-01	IC	BD7941AT-V5	R722	1-247-807-31	CARBON	100 5% 1/4W
IC702	8-759-562-43	IC	TDA6108JF/N1B	R723	1-247-807-31	CARBON	100 5% 1/4W
IC703	8-759-701-59	IC	NJM78M09FA	R724	1-247-807-31	CARBON	100 5% 1/4W
JACK							
 J701	1-451-470-21	SOCKET, CRT		R725	1-216-825-11	METAL CHIP	2.2K 5% 1/10W
COIL							
L701	1-410-482-31	INDUCTOR	100µH	R726	1-216-829-11	METAL CHIP	4.7K 5% 1/10W
TRANSISTOR							
Q700	8-729-422-27	TRANSISTOR	2SD601A-Q	R727	1-216-825-11	METAL CHIP	2.2K 5% 1/10W
Q701	8-729-422-27	TRANSISTOR	2SD601A-Q	R731	1-216-864-11	SHORT CHIP	
Q703	8-729-422-27	TRANSISTOR	2SD601A-Q	R732	1-216-833-11	METAL CHIP	10K 5% 1/10W
RESISTOR							
R700	1-249-433-11	CARBON	22K 5% 1/4W	R733	1-216-833-11	METAL CHIP	10K 5% 1/10W
R701	1-216-833-11	METAL CHIP	10K 5% 1/10W	R734	1-216-809-11	METAL CHIP	100 5% 1/10W
R702	1-216-811-11	METAL CHIP	150 5% 1/10W	VARIABLE RESISTOR			
R703	1-216-809-11	METAL CHIP	100 5% 1/10W	 RV701	1-241-656-11	RES, ADJ, METAL FILM	110M
R704	1-249-419-11	CARBON	1.5K 5% 1/4W	RV702	1-238-019-11	RES, ADJ, METAL FILM	47K
R705	1-249-429-11	CARBON	10K 5% 1/4W	M			
R706	1-249-381-11	CARBON	1 5% 1/4W	* A-1056-113-A	M (VAR) BOARD, MOUNTED (KV-32FS320 ONLY)		
R707	1-249-383-11	CARBON	1.5 5% 1/4W	* A-1057-456-A	M (VAR) BOARD, MOUNTED (KV-27FS320 ONLY)		
R708	1-247-807-31	CARBON	100 5% 1/4W	* A-1060-077-A	M (VAR) BOARD, MOUNTED (KV-36FS120, 38FS120 L. NORTH ONLY)		
R709	1-247-807-31	CARBON	100 5% 1/4W	* A-1061-529-A	M (VAR) BOARD, MOUNTED (KV-36FS320 ONLY)		
				* A-1415-721-A	M (VAR) BOARD, MOUNTED (KV-32FS120, 34FS120 ONLY)		
				CAPACITOR			
				C003	1-162-919-11	CERAMIC CHIP	22pF 5% 50V
				C004	1-162-923-11	CERAMIC CHIP	47pF 5% 50V
				C005	1-162-966-11	CERAMIC CHIP	0.0022µF 10% 50V
				C006	1-126-767-11	ELECT	1000µF 20% 16V
				C007	1-164-315-11	CERAMIC CHIP	470pF 5% 50V

NOTE: The components identified by shading and \triangle mark are critical for safety. Replace only with part number specified.

NOTE: Les composants identifiés par un triangle et une marque \triangle sont critiques pour la sécurité. Ne les remplacer que par une pièce portant le numéro spécifique.



REF. NO.	PART NO.	DESCRIPTION	VALUES			REF. NO.	PART NO.	DESCRIPTION	VALUES		
C008	1-107-826-11	CERAMIC CHIP	0.1 μ F	10%	16V	C319	1-216-864-11	SHORT CHIP			
C009	1-164-230-11	CERAMIC CHIP	220pF	5%	50V			(KV-32FS120, 34FS120, 36FS120, 38FS120 L. NORTH ONLY)			
C010	1-127-573-11	CERAMIC CHIP	1 μ F	10%	16V	C320	1-107-826-11	CERAMIC CHIP	0.1 μ F	10%	16V
C011	1-162-964-11	CERAMIC CHIP	0.001 μ F	10%	50V			(KV-27FS320, 32FS320, 36FS320 ONLY)			
C012	1-162-968-11	CERAMIC CHIP	0.0047 μ F	10%	50V	C320	1-216-864-11	SHORT CHIP			
								(KV-32FS120, 34FS120, 36FS120, 38FS120 L. NORTH ONLY)			
C014	1-127-573-11	CERAMIC CHIP	1 μ F	10%	16V	C321	1-126-947-11	ELECT	47 μ F	20%	35V
C015	1-107-826-11	CERAMIC CHIP	0.1 μ F	10%	16V			(KV-27FS320, 32FS320, 36FS320 ONLY)			
C019	1-107-826-11	CERAMIC CHIP	0.1 μ F	10%	16V	C322	1-107-826-11	CERAMIC CHIP	0.1 μ F	10%	16V
C021	1-107-826-11	CERAMIC CHIP	0.1 μ F	10%	16V	C325	1-162-967-11	CERAMIC CHIP	0.0033 μ F	10%	50V
C022	1-126-964-11	ELECT	10 μ F	20%	50V	C326	1-164-505-11	CERAMIC CHIP	2.2 μ F		16V
C023	1-126-935-11	ELECT	470 μ F	20%	16V	C330	1-107-826-11	CERAMIC CHIP	0.1 μ F	10%	16V
C033	1-162-970-11	CERAMIC CHIP	0.01 μ F	10%	25V	C337	1-162-919-11	CERAMIC CHIP	22pF	5%	50V
C041	1-126-964-11	ELECT	10 μ F	20%	50V	C351	1-164-315-11	CERAMIC CHIP	470pF	5%	50V
C047	1-164-315-11	CERAMIC CHIP	470pF	5%	50V	C370	1-162-970-11	CERAMIC CHIP	0.01 μ F	10%	25V
C048	1-104-665-11	ELECT	100 μ F	20%	25V	C390	1-162-970-11	CERAMIC CHIP	0.01 μ F	10%	25V
C064	1-165-176-11	CERAMIC CHIP	0.047 μ F	10%	16V	C511	1-126-964-11	ELECT	10 μ F	20%	50V
C090	1-162-970-11	CERAMIC CHIP	0.01 μ F	10%	25V	C542	1-162-966-11	CERAMIC CHIP	0.0022 μ F	10%	50V
C091	1-126-947-11	ELECT	47 μ F	20%	35V	C551	1-127-573-11	CERAMIC CHIP	1 μ F	10%	16V
C092	1-126-947-11	ELECT	47 μ F	20%	35V	C552	1-124-779-00	ELECT CHIP	10 μ F	20%	16V
C094	1-162-970-11	CERAMIC CHIP	0.01 μ F	10%	25V	C559	1-216-864-11	SHORT CHIP			
C095	1-126-947-11	ELECT	47 μ F	20%	35V	C665	1-104-665-11	ELECT	100 μ F	20%	25V
C096	1-162-970-11	CERAMIC CHIP	0.01 μ F	10%	25V	C666	1-104-665-11	ELECT	100 μ F	20%	25V
C097	1-126-947-11	ELECT	47 μ F	20%	35V	C780	1-162-926-11	CERAMIC CHIP	82pF	5%	50V
C098	1-162-970-11	CERAMIC CHIP	0.01 μ F	10%	25V	C781	1-162-926-11	CERAMIC CHIP	82pF	5%	50V
C099	1-126-947-11	ELECT	47 μ F	20%	35V	C782	1-162-926-11	CERAMIC CHIP	82pF	5%	50V
C100	1-107-826-11	CERAMIC CHIP	0.1 μ F	10%	16V	C3049	1-127-573-11	CERAMIC CHIP	1 μ F	10%	16V
C101	1-126-940-11	ELECT	330 μ F	20%	25V	C3051	1-126-964-11	ELECT	10 μ F	20%	50V
C102	1-115-416-11	CERAMIC CHIP	0.001 μ F	5%	25V	C3052	1-164-230-11	CERAMIC CHIP	220pF	5%	50V
C103	1-126-947-11	ELECT	47 μ F	20%	35V	C3053	1-165-176-11	CERAMIC CHIP	0.047 μ F	10%	16V
C115	1-164-739-11	CERAMIC CHIP	560pF	5%	50V	C3054	1-127-573-11	CERAMIC CHIP	1 μ F	10%	16V
C116	1-107-826-11	CERAMIC CHIP	0.1 μ F	10%	16V	C3057	1-107-826-11	CERAMIC CHIP	0.1 μ F	10%	16V
C304	1-107-826-11	CERAMIC CHIP	0.1 μ F	10%	16V	C3307	1-107-826-11	CERAMIC CHIP	0.1 μ F	10%	16V
C305	1-107-826-11	CERAMIC CHIP	0.1 μ F	10%	16V	C3314	1-107-826-11	CERAMIC CHIP	0.1 μ F	10%	16V
C306	1-107-826-11	CERAMIC CHIP	0.1 μ F	10%	16V			(KV-27FS320, 32FS320, 36FS320 ONLY)			
C313	1-107-826-11	CERAMIC CHIP	0.1 μ F	10%	16V	C3315	1-126-947-11	ELECT	47 μ F	20%	35V
C316	1-107-826-11	CERAMIC CHIP	0.1 μ F	10%	16V			(KV-27FS320, 32FS320, 36FS320 ONLY)			
		(KV-27FS320, 32FS320, 36FS320 ONLY)				C3509	1-124-779-00	ELECT CHIP	10 μ F	20%	16V
C317	1-107-826-11	CERAMIC CHIP	0.1 μ F	10%	16V	C3519	1-165-176-11	CERAMIC CHIP	0.047 μ F	10%	16V
		(KV-27FS320, 32FS320, 36FS320 ONLY)						(ALL EXCEPT KV-27FS320)			
C318	1-107-826-11	CERAMIC CHIP	0.1 μ F	10%	16V	C3519	1-216-864-11	SHORT CHIP			
		(KV-27FS320, 32FS320, 36FS320 ONLY)						(KV-27FS320 ONLY)			
C319	1-107-826-11	CERAMIC CHIP	0.1 μ F	10%	16V	C3520	1-126-933-11	ELECT	100 μ F	20%	16V
		(KV-27FS320, 32FS320, 36FS320 ONLY)				C3534	1-162-966-11	CERAMIC CHIP	0.0022 μ F	10%	50V



REF. NO.	PART NO.	DESCRIPTION	VALUES	REF. NO.	PART NO.	DESCRIPTION	VALUES
C3536	1-115-416-11	CERAMIC CHIP (ALL EXCEPT KV-27FS320)	0.001μF 5% 25V	D045	8-719-977-28	DIODE	DTZ10B
C3536	1-162-968-11	CERAMIC CHIP (KV-27FS320 ONLY)	0.0047μF 10% 50V	D050	8-719-510-02	DIODE	D1NS4
C3539	1-162-970-11	CERAMIC CHIP	0.01μF 10% 25V	D051	6-500-567-21	DIODE	10ERB20-TB5
C3542	1-115-414-11	CERAMIC CHIP (ALL EXCEPT KV-27FS320)	820pF 25V	D052	8-719-069-55	DIODE	UDZSTE-175.6B
C3553	1-107-826-11	CERAMIC CHIP	0.1μF 10% 16V	D110	8-719-404-50	DIODE	MA111-TX
C3554	1-162-970-11	CERAMIC CHIP	0.01μF 10% 25V	D250	1-803-974-21	VARISTOR, CHIP	(1608)
C3560	1-216-833-11	METAL CHIP	10K 5% 1/10W	D304	1-803-974-21	VARISTOR, CHIP	(1608)
C3611	1-126-933-11	ELECT	100μF 20% 16V	D351	6-500-697-01	DIODE	UDZSTE-173.3B
C3612	1-126-933-11	ELECT	100μF 20% 16V	D390	8-719-404-50	DIODE	MA111-TX
C3613	1-126-933-11	ELECT	100μF 20% 16V	D512	8-719-404-50	DIODE	MA111-TX
C3638	1-104-665-11	ELECT	100μF 20% 25V	D513	8-719-404-50	DIODE	MA111-TX
C3901	1-126-933-11	ELECT	100μF 20% 16V	D558	8-719-404-50	DIODE	MA111-TX
C3902	1-107-826-11	CERAMIC CHIP	0.1μF 10% 16V	D559	8-719-404-50	DIODE	MA111-TX
C3984	1-126-964-11	ELECT (KV-27FS320, 32FS320, 36FS320 ONLY)	10μF 20% 50V	D762	8-719-404-50	DIODE	MA111-TX
C3988	1-126-964-11	ELECT (KV-27FS320, 32FS320, 36FS320 ONLY)	10μF 20% 50V	D763	8-719-404-50	DIODE	MA111-TX
C3989	1-126-964-11	ELECT (KV-27FS320, 32FS320, 36FS320 ONLY)	10μF 20% 50V	D772	8-719-404-50	DIODE	MA111-TX
C3990	1-126-964-11	ELECT (KV-27FS320, 32FS320, 36FS320 ONLY)	10μF 20% 50V	D773	8-719-404-50	DIODE	MA111-TX
C3991	1-126-964-11	ELECT (KV-27FS320, 32FS320, 36FS320 ONLY)	10μF 20% 50V	D782	8-719-404-50	DIODE	MA111-TX
C3994	1-126-964-11	ELECT (KV-27FS320, 32FS320, 36FS320 ONLY)	10μF 20% 50V	D783	8-719-404-50	DIODE	MA111-TX
C3995	1-124-778-00	ELECT CHIP	22μF 20% 6.3V	D3305	1-803-974-21	VARISTOR, CHIP (KV-27FS320, 32FS320, 36FS320 ONLY)	(1608)
C6003	1-127-573-11	CERAMIC CHIP	1μF 10% 16V	D3306	1-803-974-21	VARISTOR, CHIP (KV-27FS320, 32FS320, 36FS320 ONLY)	(1608)
CONNECTOR				D3307	1-803-974-21	VARISTOR, CHIP (KV-27FS320, 32FS320, 36FS320 ONLY)	(1608)
*	CN001	1-560-124-00	PLUG, CONNECTOR (2.5MM) 4P (KV-27FS320, 32FS320, 32FS120, 34FS120 ONLY)	D3308	1-803-974-21	VARISTOR, CHIP (KV-27FS320, 32FS320, 36FS320 ONLY)	(1608)
*	CN002	1-764-812-12	PLUG, CONNECTOR 11P (KV-36FS120, 38FS120 L. NORTH, 36FS320 ONLY)	D3509	1-803-974-21	VARISTOR, CHIP	(1608)
*	CN302	1-564-515-11	PLUG, CONNECTOR 12P (KV-27FS320, 32FS320, 36FS320 ONLY)	FERRITE BEAD			
DIODE				FB302	1-469-549-21	INDUCTOR	1μH
D002	8-719-069-55	DIODE	UDZSTE-175.6B	FILTER			
D004	8-719-977-28	DIODE	DTZ10B	FL001	1-234-126-21	FERRITE	0μH
D005	8-719-977-28	DIODE	DTZ10B	IC			
D006	8-719-069-55	DIODE	UDZSTE-175.6B	IC001	6-804-652-01	IC	M65585μF-104FP
D044	8-719-977-28	DIODE	DTZ10B	IC002	6-704-607-01	IC	M24C16-WMN6T(B)
				IC003	8-759-352-91	IC	PST9143NL
				IC004	8-759-533-85	IC	L88M05T-FA-TL
				IC301	6-701-105-01	IC (KV-27FS320, 32FS320, 36FS320 ONLY)	NJM2750M-TE2



REF. NO.	PART NO.	DESCRIPTION	VALUES			REF. NO.	PART NO.	DESCRIPTION	VALUES		
IC565	8-759-700-44	IC	NJM2902M			Q519	8-729-422-27	TRANSISTOR	2SD601A-Q		
IC633	8-759-641-26	IC	NJM2391DL1-33(TE1)			Q533	8-729-424-02	TRANSISTOR	2SB709A-QRS-TX		
IC3001	8-759-443-11	IC	NJM2283M-TE1			Q761	8-729-422-27	TRANSISTOR	2SD601A-Q		
	(KV-27FS320, 32FS320, 36FS320 ONLY)					Q762	8-729-422-27	TRANSISTOR	2SD601A-Q		
	CHIP CONDUCTOR					Q763	8-729-422-27	TRANSISTOR	2SD601A-Q		
JR44	1-216-864-11	SHORT CHIP				Q771	8-729-422-27	TRANSISTOR	2SD601A-Q		
JR317	1-216-809-11	METAL CHIP	100	5%	1/10W	Q772	8-729-422-27	TRANSISTOR	2SD601A-Q		
JR318	1-216-864-11	SHORT CHIP				Q773	8-729-422-27	TRANSISTOR	2SD601A-Q		
JR546	1-216-864-11	SHORT CHIP				Q781	8-729-422-27	TRANSISTOR	2SD601A-Q		
JR3503	1-216-864-11	SHORT CHIP				Q782	8-729-422-27	TRANSISTOR	2SD601A-Q		
	COIL					Q783	8-729-422-27	TRANSISTOR	2SD601A-Q		
L002	1-234-126-21	FERRITE	0μH			Q860	8-729-422-27	TRANSISTOR	2SD601A-Q		
L005	1-234-126-21	FERRITE	0μH			Q3005	8-729-424-02	TRANSISTOR	2SB709A-QRS-TX		
L006	1-414-273-11	INDUCTOR	100μH			Q3300	8-729-422-27	TRANSISTOR	2SD601A-Q		
L007	1-414-267-21	INDUCTOR	10μH			Q3304	8-729-424-02	TRANSISTOR	2SB709A-QRS-TX		
L011	1-234-126-21	FERRITE	0μH			Q3502	8-729-422-27	TRANSISTOR	2SD601A-Q		
L301	1-469-555-21	INDUCTOR	10μH			Q6000	8-729-422-27	TRANSISTOR	2SD601A-Q		
	(KV-27FS320, 32FS320, 36FS320 ONLY)						RESISTOR				
L611	1-469-561-21	INDUCTOR	100μH			R002	1-216-864-11	SHORT CHIP			
L612	1-469-561-21	INDUCTOR	100μH			R003	1-216-821-11	METAL CHIP	1K	5%	1/10W
L613	1-469-561-21	INDUCTOR	100μH			R004	1-216-817-11	METAL CHIP	470	5%	1/10W
L710	1-410-387-11	INDUCTOR	33μH			R005	1-400-427-21	FERRITE	0μH		
L711	1-410-387-11	INDUCTOR	33μH			R006	1-216-829-11	METAL CHIP	4.7K	5%	1/10W
L712	1-410-387-11	INDUCTOR	33μH			R007	1-400-427-21	FERRITE	0μH		
L3003	1-234-126-21	FERRITE	0μH			R008	1-216-864-11	SHORT CHIP			
L3004	1-234-126-21	FERRITE	0μH			R009	1-216-864-11	SHORT CHIP			
L3609	1-414-267-21	INDUCTOR	10μH			R010	1-216-813-11	METAL CHIP	220	5%	1/10W
	TRANSISTOR						(KV-27FS320, 32FS320, 36FS320 ONLY)				
Q002	8-729-422-27	TRANSISTOR	2SD601A-Q			R015	1-216-833-11	METAL CHIP	10K	5%	1/10W
Q004	8-729-422-27	TRANSISTOR	2SD601A-Q			R027	1-218-887-11	METAL CHIP	47K	0.50%	1/10W
Q008	8-729-422-27	TRANSISTOR	2SD601A-Q			R028	1-216-813-11	METAL CHIP	220	5%	1/10W
Q301	8-729-424-02	TRANSISTOR	2SB709A-QRS-TX			R030	1-216-813-11	METAL CHIP	220	5%	1/10W
Q303	8-729-424-02	TRANSISTOR	2SB709A-QRS-TX			R031	1-216-813-11	METAL CHIP	220	5%	1/10W
Q305	8-729-424-02	TRANSISTOR	2SB709A-QRS-TX			R032	1-216-813-11	METAL CHIP	220	5%	1/10W
Q306	8-729-422-27	TRANSISTOR	2SD601A-Q			R034	1-216-864-11	SHORT CHIP			
Q307	8-729-424-02	TRANSISTOR	2SB709A-QRS-TX			R035	1-216-809-11	METAL CHIP	100	5%	1/10W
Q316	8-729-422-27	TRANSISTOR	2SD601A-Q			R037	1-216-833-11	METAL CHIP	10K	5%	1/10W
Q390	8-729-422-27	TRANSISTOR	2SD601A-Q			R038	1-216-813-11	METAL CHIP	220	5%	1/10W
Q391	8-729-422-27	TRANSISTOR	2SD601A-Q			R039	1-216-813-11	METAL CHIP	220	5%	1/10W
Q503	8-729-422-27	TRANSISTOR	2SD601A-Q			R040	1-216-829-11	METAL CHIP	4.7K	5%	1/10W
Q504	8-729-422-27	TRANSISTOR	2SD601A-Q			R041	1-216-829-11	METAL CHIP	4.7K	5%	1/10W
Q505	8-729-422-27	TRANSISTOR	2SD601A-Q			R042	1-216-813-11	METAL CHIP	220	5%	1/10W
Q515	8-729-422-27	TRANSISTOR	2SD601A-Q			R043	1-216-813-11	METAL CHIP	220	5%	1/10W



REF. NO.	PART NO.	DESCRIPTION	VALUES			REF. NO.	PART NO.	DESCRIPTION	VALUES		
R044	1-216-829-11	METAL CHIP	4.7K	5%	1/10W	R310	1-216-821-11	METAL CHIP	1K	5%	1/10W
R045	1-216-829-11	METAL CHIP	4.7K	5%	1/10W	R311	1-216-813-11	METAL CHIP	220	5%	1/10W
R047	1-216-813-11	METAL CHIP	220	5%	1/10W	R312	1-218-867-11	METAL CHIP	6.8K	0.50%	1/10W
R048	1-216-829-11	METAL CHIP	4.7K	5%	1/10W	R313	1-216-864-11	SHORT CHIP			
R049	1-216-829-11	METAL CHIP	4.7K	5%	1/10W	R314	1-216-833-11	METAL CHIP	10K	5%	1/10W
R050	1-216-829-11	METAL CHIP	4.7K	5%	1/10W	R318	1-216-825-11	METAL CHIP	2.2K	5%	1/10W
R053	1-216-837-11	METAL CHIP	22K	5%	1/10W	R319	1-216-813-11	METAL CHIP	220	5%	1/10W
R054	1-216-837-11	METAL CHIP	22K	5%	1/10W	R320	1-216-825-11	METAL CHIP	2.2K	5%	1/10W
R059	1-216-821-11	METAL CHIP	1K	5%	1/10W	R321	1-216-864-11	SHORT CHIP			
R060	1-216-813-11	METAL CHIP	220	5%	1/10W	R322	1-216-864-11	SHORT CHIP			
R061	1-216-833-11	METAL CHIP	10K	5%	1/10W	R324	1-216-821-11	METAL CHIP	1K	5%	1/10W
R062	1-216-817-11	METAL CHIP	470	5%	1/10W	R325	1-216-864-11	SHORT CHIP			
R063	1-216-829-11	METAL CHIP	4.7K	5%	1/10W	R326	1-400-427-21	FERRITE	0μH		
R070	1-216-813-11	METAL CHIP	220	5%	1/10W	R329	1-216-813-11	METAL CHIP	220	5%	1/10W
R071	1-216-809-11	METAL CHIP	100	5%	1/10W			(KV-27FS320, 32FS320, 36FS320 ONLY)			
		(KV-27FS320, 32FS320, 36FS320 ONLY)				R331	1-216-864-11	SHORT CHIP			
R076	1-216-809-11	METAL CHIP	100	5%	1/10W	R332	1-216-864-11	SHORT CHIP			
R080	1-216-833-11	METAL CHIP	10K	5%	1/10W	R333	1-216-813-11	METAL CHIP	220	5%	1/10W
R081	1-216-841-11	METAL CHIP	47K	5%	1/10W			(KV-27FS320, 32FS320, 36FS320 ONLY)			
R082	1-216-857-11	METAL CHIP	1M	5%	1/10W	R336	1-216-864-11	SHORT CHIP			
R083	1-216-847-11	METAL CHIP	150K	5%	1/10W			(KV-32FS120, 34FS120, 36FS120, 38FS120 L. NORTH ONLY)			
R084	1-216-819-11	METAL CHIP	680	5%	1/10W	R337	1-216-801-11	METAL CHIP	22	5%	1/10W
R090	1-216-837-11	METAL CHIP	22K	5%	1/10W	R338	1-216-845-11	METAL CHIP	100K	5%	1/10W
R091	1-216-841-11	METAL CHIP	47K	5%	1/10W			(KV-27FS320, 32FS320, 36FS320 ONLY)			
R092	1-216-825-11	METAL CHIP	2.2K	5%	1/10W	R339	1-216-845-11	METAL CHIP	100K	5%	1/10W
R093	1-216-841-11	METAL CHIP	47K	5%	1/10W			(KV-27FS320, 32FS320, 36FS320 ONLY)			
R094	1-216-864-11	SHORT CHIP				R341	1-218-845-11	METAL CHIP	820	0.50%	1/10W
R095	1-216-864-11	SHORT CHIP				R342	1-218-847-11	METAL CHIP	1K	0.50%	1/10W
R096	1-216-813-11	METAL CHIP	220	5%	1/10W	R343	1-216-827-11	METAL CHIP	3.3K	5%	1/10W
R097	1-216-813-11	METAL CHIP	220	5%	1/10W	R344	1-216-821-11	METAL CHIP	1K	5%	1/10W
R100	1-216-849-11	METAL CHIP	220K	5%	1/10W	R345	1-216-864-11	SHORT CHIP			
R101	1-216-829-11	METAL CHIP	4.7K	5%	1/10W	R346	1-216-864-11	SHORT CHIP			
R110	1-216-813-11	METAL CHIP	220	5%	1/10W			(KV-32FS120, 34FS120, 36FS120, 38FS120 L. NORTH ONLY)			
R112	1-216-829-11	METAL CHIP	4.7K	5%	1/10W	R347	1-216-813-11	METAL CHIP	220	5%	1/10W
R115	1-216-817-11	METAL CHIP	470	5%	1/10W			(KV-27FS320, 32FS320, 36FS320 ONLY)			
R116	1-216-853-11	METAL CHIP	470K	5%	1/10W	R347	1-216-864-11	SHORT CHIP			
								(KV-32FS120, 34FS120, 36FS120, 38FS120 L. NORTH ONLY)			
R131	1-216-813-11	METAL CHIP	220	5%	1/10W	R351	1-216-829-11	METAL CHIP	4.7K	5%	1/10W
R201	1-216-813-11	METAL CHIP	220	5%	1/10W	R352	1-216-853-11	METAL CHIP	470K	5%	1/10W
R203	1-216-813-11	METAL CHIP	220	5%	1/10W	R353	1-216-864-11	SHORT CHIP			
R211	1-216-864-11	SHORT CHIP				R354	1-216-864-11	SHORT CHIP			
		(KV-27FS320, 32FS320, 36FS320 ONLY)				R355	1-216-864-11	SHORT CHIP			
R212	1-216-864-11	SHORT CHIP				R370	1-216-825-11	METAL CHIP	2.2K	5%	1/10W
R213	1-216-829-11	METAL CHIP	4.7K	5%	1/10W	R371	1-216-849-11	METAL CHIP	220K	5%	1/10W
R309	1-216-833-11	METAL CHIP	10K	5%	1/10W						



REF. NO.	PART NO.	DESCRIPTION	VALUES			REF. NO.	PART NO.	DESCRIPTION	VALUES		
R372	1-216-827-11	METAL CHIP	3.3K	5%	1/10W	R861	1-216-833-11	METAL CHIP	10K	5%	1/10W
R382	1-216-863-11	METAL CHIP	3.3M	5%	1/10W	R862	1-216-813-11	METAL CHIP	220	5%	1/10W
R511	1-216-864-11	SHORT CHIP				R900	1-216-851-11	METAL CHIP	330K	5%	1/10W
R513	1-216-845-11	METAL CHIP	100K	5%	1/10W	R3057	1-216-821-11	METAL CHIP	1K	5%	1/10W
R515	1-216-845-11	METAL CHIP	100K	5%	1/10W	R3058	1-216-833-11	METAL CHIP	10K	5%	1/10W
R526	1-216-837-11	METAL CHIP	22K	5%	1/10W	R3085	1-216-864-11	SHORT CHIP			
R540	1-216-833-11	METAL CHIP	10K	5%	1/10W	R3086	1-216-821-11	METAL CHIP	1K	5%	1/10W
R547	1-218-891-11	METAL CHIP	68K	0.50%	1/10W	R3087	1-216-809-11	METAL CHIP	100	5%	1/10W
R556	1-216-825-11	METAL CHIP	2.2K	5%	1/10W	R3115	1-216-864-11	SHORT CHIP			
R557	1-216-825-11	METAL CHIP	2.2K	5%	1/10W	R3303	1-216-863-11	METAL CHIP	3.3M	5%	1/10W
R634	1-215-905-11	METAL OXIDE	10	5%	3W	R3305	1-216-809-11	METAL CHIP	100	5%	1/10W
R759	1-216-864-11	SHORT CHIP				R3308	1-216-809-11	METAL CHIP	100	5%	1/10W
R760	1-216-829-11	METAL CHIP	4.7K	5%	1/10W	R3315	1-216-813-11	METAL CHIP	220	5%	1/10W
R762	1-218-847-11	METAL CHIP	1K	0.50%	1/10W	R3316	1-216-825-11	METAL CHIP	2.2K	5%	1/10W
R763	1-216-835-11	METAL CHIP	15K	5%	1/10W	R3317	1-216-813-11	METAL CHIP	220	5%	1/10W
R764	1-218-833-11	METAL CHIP	270	0.50%	1/10W	R3328	1-216-864-11	SHORT CHIP			
R765	1-218-855-11	METAL CHIP	2.2K	0.50%	1/10W	R3334	1-216-813-11	METAL CHIP	220	5%	1/10W
R766	1-216-827-11	METAL CHIP	3.3K	5%	1/10W			(KV-27FS320, 32FS320, 36FS320 ONLY)			
R767	1-216-830-11	METAL CHIP	5.6K	5%	1/10W	R3334	1-216-864-11	SHORT CHIP			
R768	1-216-821-11	METAL CHIP	1K	5%	1/10W			(KV-32FS120, 34FS120, 36FS120, 38FS120 L. NORTH ONLY)			
R769	1-216-821-11	METAL CHIP	1K	5%	1/10W	R3335	1-216-813-11	METAL CHIP	220	5%	1/10W
R770	1-216-829-11	METAL CHIP	4.7K	5%	1/10W			(KV-27FS320, 32FS320, 36FS320 ONLY)			
R771	1-216-821-11	METAL CHIP	1K	5%	1/10W	R3390	1-216-864-11	SHORT CHIP			
R772	1-218-847-11	METAL CHIP	1K	0.50%	1/10W	R3391	1-216-829-11	METAL CHIP	4.7K	5%	1/10W
R773	1-216-835-11	METAL CHIP	15K	5%	1/10W	R3392	1-216-818-11	METAL CHIP	560	5%	1/10W
R774	1-218-833-11	METAL CHIP	270	0.50%	1/10W	R3393	1-216-825-11	METAL CHIP	2.2K	5%	1/10W
R775	1-218-855-11	METAL CHIP	2.2K	0.50%	1/10W	R3394	1-216-833-11	METAL CHIP	10K	5%	1/10W
R776	1-216-827-11	METAL CHIP	3.3K	5%	1/10W	R3395	1-216-864-11	SHORT CHIP			
R777	1-216-830-11	METAL CHIP	5.6K	5%	1/10W	R3396	1-216-864-11	SHORT CHIP			
R778	1-216-821-11	METAL CHIP	1K	5%	1/10W	R3517	1-218-881-11	METAL CHIP	27K	0.50%	1/10W
R779	1-216-821-11	METAL CHIP	1K	5%	1/10W	R3518	1-216-833-11	METAL CHIP	10K	5%	1/10W
R780	1-216-829-11	METAL CHIP	4.7K	5%	1/10W	R3519	1-216-833-11	METAL CHIP	10K	5%	1/10W
R782	1-218-847-11	METAL CHIP	1K	0.50%	1/10W	R3524	1-218-867-11	METAL CHIP	6.8K	0.50%	1/10W
R783	1-216-835-11	METAL CHIP	15K	5%	1/10W	R3525	1-216-821-11	METAL CHIP	1K	5%	1/10W
R784	1-218-833-11	METAL CHIP	270	0.50%	1/10W	R3527	1-216-825-11	METAL CHIP	2.2K	5%	1/10W
R785	1-218-855-11	METAL CHIP	2.2K	0.50%	1/10W	R3528	1-216-833-11	METAL CHIP	10K	5%	1/10W
R786	1-216-827-11	METAL CHIP	3.3K	5%	1/10W	R3529	1-216-833-11	METAL CHIP	10K	5%	1/10W
R787	1-216-830-11	METAL CHIP	5.6K	5%	1/10W	R3530	1-218-865-11	METAL CHIP	5.6K	0.50%	1/10W
R788	1-216-821-11	METAL CHIP	1K	5%	1/10W	R3532	1-216-864-11	SHORT CHIP			
R789	1-216-864-11	SHORT CHIP				R3533	1-218-869-11	METAL CHIP	8.2K	0.50%	1/10W
R794	1-216-864-11	SHORT CHIP				R3534	1-218-720-11	METAL CHIP	15K	0.50%	1/10W
R851	1-216-821-11	METAL CHIP	1K	5%	1/10W	R3535	1-218-865-11	METAL CHIP	5.6K	0.50%	1/10W
R852	1-218-887-11	METAL CHIP	47K	0.50%	1/10W	R3536	1-218-869-11	METAL CHIP	8.2K	0.50%	1/10W
R860	1-216-833-11	METAL CHIP	10K	5%	1/10W	R3537	1-216-855-11	METAL CHIP	680K	5%	1/10W



REF. NO.	PART NO.	DESCRIPTION	VALUES			REF. NO.	PART NO.	DESCRIPTION	VALUES		
R3539	1-216-864-11	SHORT CHIP				CRYSTAL					
R3541	1-216-830-11	METAL CHIP	5.6K	5%	1/10W	X001	1-795-006-21	VIBRATOR, CRYSTAL			
R3542	1-216-833-11	METAL CHIP	10K	5%	1/10W	X301	1-781-377-21	VIBRATOR, CRYSTAL			
R3543	1-216-815-11	METAL CHIP	330	5%	1/10W						
R3550	1-216-817-11	METAL CHIP	470	5%	1/10W						
R3551	1-216-829-11	METAL CHIP	4.7K	5%	1/10W						
R3553	1-216-813-11	METAL CHIP	220	5%	1/10W						
R3554	1-216-827-11	METAL CHIP	3.3K	5%	1/10W						
R3555	1-216-833-11	METAL CHIP	10K	5%	1/10W						
R3559	1-216-837-11	METAL CHIP	22K	5%	1/10W						
						* A-1057-460-A V (VAR) BOARD, MOUNTED (KV-27FS320 ONLY)					
						* A-1415-719-A V (VAR) BOARD, MOUNTED (ALL EXCEPT KV-27FS320)					
R3580	1-216-837-11	METAL CHIP	22K	5%	1/10W						
R3599	1-216-837-11	METAL CHIP	22K	5%	1/10W						
R3900	1-216-809-11	METAL CHIP	100	5%	1/10W						
		(KV-32FS120, 34FS120, 36FS120, 38FS120 L. NORTH ONLY)									
R3901	1-216-809-11	METAL CHIP	100	5%	1/10W	C802	1-126-964-11	ELECT	10µF	20%	50V
		(KV-32FS120, 34FS120, 36FS120, 38FS120 L. NORTH ONLY)									
R3902	1-216-809-11	METAL CHIP	100	5%	1/10W	C803	1-137-378-11	MYLAR	0.22µF	5%	50V
		(KV-32FS120, 34FS120, 36FS120, 38FS120 L. NORTH ONLY)									
R3903	1-218-285-11	METAL CHIP	75	5%	1/10W	C804	1-137-378-11	MYLAR	0.22µF	5%	50V
		(KV-27FS320, 32FS320, 36FS320 ONLY)									
R3904	1-216-813-11	METAL CHIP	220	5%	1/10W	C805	1-131-985-21	FILM	0.033µF	5%	250V
		(KV-27FS320, 32FS320, 36FS320 ONLY)									
R3905	1-216-813-11	METAL CHIP	220	5%	1/10W	C808	1-162-970-11	CERAMIC CHIP	0.01µF	10%	25V
		(KV-27FS320, 32FS320, 36FS320 ONLY)									
R3906	1-218-285-11	METAL CHIP	75	5%	1/10W	C809	1-128-934-91	CERAMIC CHIP	0.33µF	20%	10V
		(KV-27FS320, 32FS320, 36FS320 ONLY)									
R3907	1-216-813-11	METAL CHIP	220	5%	1/10W	C810	1-130-495-00	MYLAR	0.1µF	5%	50V
		(KV-27FS320, 32FS320, 36FS320 ONLY)									
R3908	1-218-285-11	METAL CHIP	75	5%	1/10W	C811	1-129-725-00	FILM	0.082µF	5%	400V
		(KV-27FS320, 32FS320, 36FS320 ONLY)									
R3910	1-216-822-11	METAL CHIP	1.2K	5%	1/10W	C812	1-162-970-11	CERAMIC CHIP	0.01µF	10%	25V
R3990	1-216-809-11	METAL CHIP	100	5%	1/10W	C813	1-126-933-11	ELECT	100µF	20%	16V
R3997	1-216-809-11	METAL CHIP	100	5%	1/10W						
		(KV-27FS320, 32FS320, 36FS320 ONLY)									
R3998	1-216-809-11	METAL CHIP	100	5%	1/10W	C821	1-162-970-11	CERAMIC CHIP	0.01µF	10%	25V
		(KV-27FS320, 32FS320, 36FS320 ONLY)									
R3999	1-216-809-11	METAL CHIP	100	5%	1/10W	C823	1-130-967-00	FILM	0.0027µF	5%	50V
		(KV-27FS320, 32FS320, 36FS320 ONLY)									
R6001	1-216-833-11	METAL CHIP	10K	5%	1/10W	C824	1-165-176-11	CERAMIC CHIP	0.047µF	10%	16V
R6002	1-216-833-11	METAL CHIP	10K	5%	1/10W	C826	1-162-927-11	CERAMIC CHIP	100pF	5%	50V
R6003	1-216-833-11	METAL CHIP	10K	5%	1/10W	C862	1-126-964-11	ELECT	10µF	20%	50V
R6004	1-216-821-11	METAL CHIP	1K	5%	1/10W	C901	1-107-667-11	ELECT	2.2µF	20%	400V
						C902	1-107-364-11	MYLAR	0.01µF	10%	200V
						C903	1-126-935-11	ELECT	470µF	20%	16V
						C904	1-130-471-00	MYLAR	0.001µF	5%	50V
						C905	1-107-364-11	MYLAR	0.01µF	10%	200V
						C906	1-130-471-00	MYLAR	0.001µF	5%	50V
						C907	1-107-963-11	ELECT	33µF	20%	250V
						C908	1-126-935-11	ELECT	470µF	20%	16V
						C909	1-104-999-11	MYLAR	0.1µF	5%	200V
						C910	1-104-999-11	MYLAR	0.1µF	5%	200V
						C911	1-126-933-11	ELECT	100µF	20%	16V
						C912	1-126-933-11	ELECT	100µF	20%	16V
						C913	1-102-074-00	CERAMIC	0.001µF	10%	50V
						C914	1-130-491-00	MYLAR	0.047µF	5%	50V
						C930	1-104-655-91	ELECT	470µF	20%	6.3V





REF. NO.	PART NO.	DESCRIPTION	VALUES	REF. NO.	PART NO.	DESCRIPTION	VALUES
C931	1-104-655-91	ELECT	470µF 20% 6.3V	CHIP CONDUCTOR			
C1815	1-129-718-00	FILM	0.022µF 5% 630V	JR802	1-216-864-11	SHORT CHIP	
C1816	1-102-244-00	CERAMIC	220pF 10% 500V	JR803	1-216-864-11	SHORT CHIP	
C1817	1-129-709-91	FILM	0.0039µF 5% 630V	COIL			
	(KV-27FS320 ONLY)			L801	1-406-989-21	INDUCTOR	10MH
C1817	1-129-928-00	FILM	0.0027µF 5% 630V	L802	1-419-633-11	INDUCTOR	10MH
	(ALL EXCEPT KV-27FS320)			L803	1-412-529-81	INDUCTOR	22µH
C1818	1-102-002-00	CERAMIC	680pF 10% 500V	L901	1-410-473-11	INDUCTOR	18µH
	(KV-27FS320 ONLY)			L1805	1-406-677-11	INDUCTOR	10MH
C1818	1-164-645-11	CERAMIC	1000pF 10% 500V	TRANSISTOR			
	(ALL EXCEPT KV-27FS320)			Q805	6-550-106-01	TRANSISTOR	KTB764
C1819	1-102-244-00	CERAMIC	220pF 10% 500V	Q807	8-729-931-45	TRANSISTOR	IRF614
	(ALL EXCEPT KV-27FS320)			Q808	6-550-106-01	TRANSISTOR	KTB764
C1820	1-109-954-11	ELECT	0.47µF 20% 160V	Q812	8-729-026-39	TRANSISTOR	2SA933AS-QT
C2801	1-128-578-11	ELECT	1µF 20% 100V	Q901	8-729-053-87	TRANSISTOR	KTC4370A
CONNECTOR				Q902	6-550-247-01	TRANSISTOR	KTA1659A
* CN901	1-564-512-11	PLUG, CONNECTOR	9P	Q903	8-729-422-27	TRANSISTOR	2SD601A-Q
* CN902	1-770-723-11	CONNECTOR, BOARD TO BOARD	8P	Q904	8-729-422-27	TRANSISTOR	2SD601A-Q
CN1802	1-785-879-11	CONNECTOR, ONE TOUCH		Q905	8-729-424-02	TRANSISTOR	2SB709A-QRS-TX
DIODE				Q906	8-729-120-28	TRANSISTOR	2SC1623-L5L6
D804	8-719-074-25	DIODE	PG104R	Q907	8-729-120-28	TRANSISTOR	2SC1623-L5L6
D805	8-719-991-33	DIODE	1SS133T-77	Q908	8-729-424-02	TRANSISTOR	2SB709A-QRS-TX
D806	8-719-991-33	DIODE	1SS133T-77	Q1810	8-729-043-95	TRANSISTOR	2SC3840(3)
D807	8-719-210-21	DIODE	11EQS04	Q2801	8-729-422-27	TRANSISTOR	2SD601A-Q
D808	8-719-991-33	DIODE	1SS133T-77	Q2802	8-729-424-02	TRANSISTOR	2SB709A-QRS-TX
D813	8-719-991-33	DIODE	1SS133T-77	Q2803	8-729-424-02	TRANSISTOR	2SB709A-QRS-TX
D901	8-719-924-11	DIODE	MTZJ-T-77-22	Q2804	8-729-424-02	TRANSISTOR	2SB709A-QRS-TX
D902	8-719-924-11	DIODE	MTZJ-T-77-22	RESISTOR			
D903	8-719-991-33	DIODE	1SS133T-77	R809	1-216-829-11	METAL CHIP	4.7K 5% 1/10W
D905	8-719-404-50	DIODE	MA111-TX		(KV-27FS320 ONLY)		
D906	8-719-404-50	DIODE	MA111-TX	R809	1-216-832-11	METAL CHIP	8.2K 5% 1/10W
D907	8-719-404-50	DIODE	MA111-TX		(ALL EXCEPT KV-27FS320)		
D908	8-719-404-50	DIODE	MA111-TX	R811	1-249-393-11	CARBON	10 5% 1/4W
D1809	8-719-110-41	DIODE	RD15ESB2	R814	1-215-862-11	METAL OXIDE	68 5% 1W
D1810	8-719-970-87	DIODE	ERA38-06		(ALL EXCEPT KV-27FS320)		
D1811	8-719-970-87	DIODE	ERA38-06	R815	1-215-862-11	METAL OXIDE	68 5% 1W
D1812	8-719-081-93	DIODE	1N4937/23	R817	1-218-879-11	METAL CHIP	22K 0.50% 1/10W
D2801	8-719-109-89	DIODE	RD5.6ESB2		(KV-27FS320 ONLY)		
D2802	8-719-991-33	DIODE	1SS133T-77	R817	1-218-877-11	METAL CHIP	18K 0.50% 1/10W
IC					(ALL EXCEPT KV-27FS320)		
IC801	6-701-598-01	IC	UPC5023CS-184				



REF. NO.	PART NO.	DESCRIPTION	VALUES			REF. NO.	PART NO.	DESCRIPTION	VALUES		
R818	1-216-809-11	METAL CHIP	100	5%	1/10W	R890	1-218-891-11	METAL CHIP	68K	0.50%	1/10W
R819	1-216-841-11	METAL CHIP	47K	5%	1/10W			(KV-27FS320 ONLY)			
R820	1-216-839-11	METAL CHIP	33K	5%	1/10W	R890	1-218-867-11	METAL CHIP	6.8K	0.50%	1/10W
		(KV-27FS320 ONLY)						(ALL EXCEPT KV-27FS320)			
R820	1-216-837-11	METAL CHIP	22K	5%	1/10W	R893	1-216-839-11	METAL CHIP	33K	5%	1/10W
		(ALL EXCEPT KV-27FS320)									
R821	1-216-830-11	METAL CHIP	5.6K	5%	1/10W	R901	1-249-405-11	CARBON	100	5%	1/4W
		(KV-27FS320 ONLY)				R902	1-249-385-11	CARBON	2.2	5%	1/4W
R821	1-216-832-11	METAL CHIP	8.2K	5%	1/10W	R903	1-249-414-11	CARBON	560	5%	1/4W
		(ALL EXCEPT KV-27FS320)				R904	1-249-432-11	CARBON	18K	5%	1/4W
R822	1-216-841-11	METAL CHIP	47K	5%	1/10W	R905	1-249-421-11	CARBON	2.2K	5%	1/4W
R824	1-218-895-11	METAL CHIP	100K	0.50%	1/10W	R906	1-249-432-11	CARBON	18K	5%	1/4W
R825	1-216-845-11	METAL CHIP	100K	5%	1/10W	R907	1-249-385-11	CARBON	2.2	5%	1/4W
R826	1-249-421-11	CARBON	2.2K	5%	1/4W	R908	1-249-414-11	CARBON	560	5%	1/4W
R827	1-218-863-11	METAL CHIP	4.7K	0.50%	1/10W	R909	1-260-316-51	CARBON	100	5%	1/2W
R828	1-218-883-11	METAL CHIP	33K	0.50%	1/10W	R910	1-215-915-11	METAL OXIDE	470	5%	3W
R829	1-216-853-11	METAL CHIP	470K	5%	1/10W	R911	1-215-405-00	METAL	220	1%	1/4W
R833	1-218-865-11	METAL CHIP	5.6K	0.50%	1/10W	R912	1-249-407-11	CARBON	150	5%	1/4W
		(KV-27FS320 ONLY)				R913	1-215-391-00	METAL	56	1%	1/4W
R833	1-218-867-11	METAL CHIP	6.8K	0.50%	1/10W	R914	1-249-416-11	CARBON	820	5%	1/4W
		(ALL EXCEPT KV-27FS320)				R915	1-249-425-11	CARBON	4.7K	5%	1/4W
R834	1-218-859-11	METAL CHIP	3.3K	0.50%	1/10W	R917	1-249-425-11	CARBON	4.7K	5%	1/4W
		(KV-27FS320 ONLY)				R918	1-249-401-11	CARBON	47	5%	1/4W
R834	1-218-855-11	METAL CHIP	2.2K	0.50%	1/10W	R919	1-249-401-11	CARBON	47	5%	1/4W
		(ALL EXCEPT KV-27FS320)				R921	1-249-429-11	CARBON	10K	5%	1/4W
R837	1-218-869-11	METAL CHIP	8.2K	0.50%	1/10W	R922	1-249-397-11	CARBON	22	5%	1/4W
		(KV-27FS320 ONLY)				R923	1-249-401-11	CARBON	47	5%	1/4W
R840	1-218-855-11	METAL CHIP	2.2K	0.50%	1/10W	R930	1-216-864-11	SHORT CHIP			
R841	1-218-863-11	METAL CHIP	4.7K	0.50%	1/10W	R931	1-249-421-11	CARBON	2.2K	5%	1/4W
		(KV-27FS320 ONLY)				R932	1-218-851-11	METAL CHIP	1.5K	0.50%	1/10W
R841	1-218-867-11	METAL CHIP	6.8K	0.50%	1/10W	R933	1-216-864-11	SHORT CHIP			
		(ALL EXCEPT KV-27FS320)				R935	1-249-405-11	CARBON	100	5%	1/4W
R842	1-218-855-11	METAL CHIP	2.2K	0.50%	1/10W	R938	1-216-864-11	SHORT CHIP			
R855	1-218-871-11	METAL CHIP	10K	0.50%	1/10W	R1845	1-249-441-11	CARBON	100K	5%	1/4W
R856	1-218-861-11	METAL CHIP	3.9K	0.50%	1/10W	R1846	1-249-441-11	CARBON	100K	5%	1/4W
R857	1-218-877-11	METAL CHIP	18K	0.50%	1/10W	R1847	1-249-441-11	CARBON	100K	5%	1/4W
		(KV-27FS320 ONLY)				R1848	1-215-894-11	METAL OXIDE	2.2K	5%	2W
R857	1-218-869-11	METAL CHIP	8.2K	0.50%	1/10W	R1849	1-243-617-71	METAL OXIDE	8.2K	5%	3W
		(ALL EXCEPT KV-27FS320)						(KV-27FS320 ONLY)			
R860	1-218-871-11	METAL CHIP	10K	0.50%	1/10W	R1849	1-243-610-71	METAL OXIDE	2.2K	5%	3W
R864	1-218-823-11	METAL CHIP	100	0.50%	1/10W			(ALL EXCEPT KV-27FS320)			
R866	1-249-438-11	CARBON	56K	5%	1/4W	R1850	1-243-617-71	METAL OXIDE	8.2K	5%	3W
								(KV-27FS320 ONLY)			
R870	1-216-825-11	METAL CHIP	2.2K	5%	1/10W	R1850	1-243-610-71	METAL OXIDE	2.2K	5%	3W
R876	1-216-821-11	METAL CHIP	1K	5%	1/10W			(ALL EXCEPT KV-27FS320)			

NOTE: The components identified by shading and  mark are critical for safety. Replace only with part number specified.

NOTE: Les composants identifiés par un trame et une  marque  sont critiques pour la sécurité. Ne les remplacer que par une pièce portant le numéro spécifique.



REF. NO.	PART NO.	DESCRIPTION	VALUES			REF. NO.	PART NO.	DESCRIPTION	VALUES		
R1851	1-215-922-11	METAL OXIDE	6.8K	5%	3W						
R1852	1-215-922-11	METAL OXIDE	6.8K	5%	3W						
R2800	1-216-837-11	METAL CHIP	22K	5%	1/10W						
R2801	1-216-841-11	METAL CHIP	47K	5%	1/10W						
R2802	1-216-833-11	METAL CHIP	10K	5%	1/10W						
R2803	1-216-837-11	METAL CHIP	22K	5%	1/10W						
R2804	1-216-833-11	METAL CHIP	10K	5%	1/10W						
R2805	1-216-829-11	METAL CHIP	4.7K	5%	1/10W						
R2807	1-216-827-11	METAL CHIP	3.3K	5%	1/10W						
R2808	1-216-833-11	METAL CHIP	10K	5%	1/10W						
TRANSFORMER											
	T504	1-424-584-31	TRANSFORMER, FERRITE (DFT)								
HN											
	* A-1054-787-A HN BOARD, MOUNTED (KV-27FS320, 32FS320, 36FS320 ONLY)										
	4-382-854-11	SCREW (M3X10), P, SW (+)									
CAPACITOR											
C1601	1-126-939-11	ELECT	10000µF	20%	16V						
C1602	1-126-964-11	ELECT	10µF	20%	50V						
C1603	1-126-964-11	ELECT	10µF	20%	50V						
CONNECTOR											
*	CN1601	1-564-506-11	PLUG, CONNECTOR 3P								
*	CN1602	1-564-506-11	PLUG, CONNECTOR 3P								
IC											
IC1600	8-759-450-47	IC	BA05T								
IC LINK											
PS1600	1-576-337-21	IC LINK	2.7A	50V							
RESISTOR											
R1600	1-205-997-31	CEMENTED	2.2	5%	10W						
						HM					
						* A-1056-114-A HM BOARD, MOUNTED (KV-27FS320, 32FS320, 36FS320 ONLY)					
Due to the complexity of this board, performing component level field repairs is not recommended. If service is required, complete board replacement is the preferred repair method. Data is provided for reference only.											
CAPACITOR											
C1301	1-162-927-11	CERAMIC CHIP	100pF	5%	50V						
C1302	1-162-927-11	CERAMIC CHIP	100pF	5%	50V						
C1303	1-162-927-11	CERAMIC CHIP	100pF	5%	50V						
C1307	1-162-927-11	CERAMIC CHIP	100pF	5%	50V						
C1308	1-162-927-11	CERAMIC CHIP	100pF	5%	50V						
C1309	1-162-927-11	CERAMIC CHIP	100pF	5%	50V						
C1311	1-124-779-00	ELECT CHIP	10µF	20%	16V						
C1315	1-107-826-11	CERAMIC CHIP	0.1µF	10%	16V						
C1325	1-107-826-11	CERAMIC CHIP	0.1µF	10%	16V						
C1327	1-124-779-00	ELECT CHIP	10µF	20%	16V						
C1328	1-107-826-11	CERAMIC CHIP	0.1µF	10%	16V						
C1329	1-124-779-00	ELECT CHIP	10µF	20%	16V						
C1330	1-107-826-11	CERAMIC CHIP	0.1µF	10%	16V						
C1331	1-124-779-00	ELECT CHIP	10µF	20%	16V						
C1333	1-107-826-11	CERAMIC CHIP	0.1µF	10%	16V						
C1334	1-107-826-11	CERAMIC CHIP	0.1µF	10%	16V						
C1335	1-107-826-11	CERAMIC CHIP	0.1µF	10%	16V						
C1336	1-107-826-11	CERAMIC CHIP	0.1µF	10%	16V						
C1337	1-127-692-11	CERAMIC CHIP	10µF	10%	16V						
C1339	1-107-826-11	CERAMIC CHIP	0.1µF	10%	16V						
C1341	1-107-826-11	CERAMIC CHIP	0.1µF	10%	16V						
C1342	1-107-826-11	CERAMIC CHIP	0.1µF	10%	16V						
C1343	1-107-826-11	CERAMIC CHIP	0.1µF	10%	16V						
C1344	1-107-826-11	CERAMIC CHIP	0.1µF	10%	16V						
C1346	1-107-826-11	CERAMIC CHIP	0.1µF	10%	16V						
C1347	1-127-692-11	CERAMIC CHIP	10µF	10%	16V						
C1348	1-107-826-11	CERAMIC CHIP	0.1µF	10%	16V						
C1349	1-107-826-11	CERAMIC CHIP	0.1µF	10%	16V						
C1350	1-107-826-11	CERAMIC CHIP	0.1µF	10%	16V						
C1351	1-107-826-11	CERAMIC CHIP	0.1µF	10%	16V						
C1352	1-107-826-11	CERAMIC CHIP	0.1µF	10%	16V						
C1353	1-124-779-00	ELECT CHIP	10µF	20%	16V						
C1354	1-124-779-00	ELECT CHIP	10µF	20%	16V						
C1355	1-107-826-11	CERAMIC CHIP	0.1µF	10%	16V						



REF. NO.	PART NO.	DESCRIPTION	VALUES			REF. NO.	PART NO.	DESCRIPTION	VALUES	
C1356	1-107-826-11	CERAMIC CHIP	0.1µF	10%	16V		CONNECTOR			
C1357	1-107-826-11	CERAMIC CHIP	0.1µF	10%	16V					
C1358	1-107-826-11	CERAMIC CHIP	0.1µF	10%	16V					
C1359	1-124-779-00	ELECT CHIP	10µF	20%	16V					
C1360	1-124-779-00	ELECT CHIP	10µF	20%	16V					
C1361	1-107-826-11	CERAMIC CHIP	0.1µF	10%	16V					
C1362	1-107-826-11	CERAMIC CHIP	0.1µF	10%	16V					
C1363	1-107-826-11	CERAMIC CHIP	0.1µF	10%	16V					
C1364	1-107-826-11	CERAMIC CHIP	0.1µF	10%	16V					
C1365	1-124-779-00	ELECT CHIP	10µF	20%	16V					
C1366	1-107-826-11	CERAMIC CHIP	0.1µF	10%	16V					
C1367	1-127-692-11	CERAMIC CHIP	10µF	10%	16V					
C1368	1-124-779-00	ELECT CHIP	10µF	20%	16V					
C1369	1-107-826-11	CERAMIC CHIP	0.1µF	10%	16V					
C1370	1-124-779-00	ELECT CHIP	10µF	20%	16V					
C1371	1-107-826-11	CERAMIC CHIP	0.1µF	10%	16V					
C1373	1-162-920-11	CERAMIC CHIP	27pF	5%	50V					
C1374	1-107-826-11	CERAMIC CHIP	0.1µF	10%	16V					
C1375	1-124-779-00	ELECT CHIP	10µF	20%	16V					
C1376	1-107-826-11	CERAMIC CHIP	0.1µF	10%	16V					
C1377	1-107-826-11	CERAMIC CHIP	0.1µF	10%	16V					
C1378	1-162-920-11	CERAMIC CHIP	27pF	5%	50V					
C1385	1-107-826-11	CERAMIC CHIP	0.1µF	10%	16V					
C1386	1-107-826-11	CERAMIC CHIP	0.1µF	10%	16V					
C1387	1-107-826-11	CERAMIC CHIP	0.1µF	10%	16V					
C1392	1-162-974-11	CERAMIC CHIP	0.01µF		50V					
C1393	1-164-346-11	CERAMIC CHIP	1µF		16V					
C1394	1-162-965-11	CERAMIC CHIP	0.0015µF	10%	50V					
C1395	1-162-965-11	CERAMIC CHIP	0.0015µF	10%	50V					
C1396	1-124-779-00	ELECT CHIP	10µF	20%	16V					
C1397	1-162-965-11	CERAMIC CHIP	0.0015µF	10%	50V					
C1398	1-124-779-00	ELECT CHIP	10µF	20%	16V					
C1399	1-162-965-11	CERAMIC CHIP	0.0015µF	10%	50V					
C1400	1-107-826-11	CERAMIC CHIP	0.1µF	10%	16V					
C1401	1-107-826-11	CERAMIC CHIP	0.1µF	10%	16V					
C1402	1-124-778-00	ELECT CHIP	22µF	20%	6.3V					
C1404	1-162-970-11	CERAMIC CHIP	0.01µF	10%	25V					
C1480	1-107-826-11	CERAMIC CHIP	0.1µF	10%	16V					
C1481	1-107-826-11	CERAMIC CHIP	0.1µF	10%	16V					
C1482	1-107-826-11	CERAMIC CHIP	0.1µF	10%	16V					
C1483	1-107-826-11	CERAMIC CHIP	0.1µF	10%	16V					
C1484	1-107-826-11	CERAMIC CHIP	0.1µF	10%	16V					
C1485	1-107-826-11	CERAMIC CHIP	0.1µF	10%	16V					
						*	CN1302	1-564-515-11	PLUG, CONNECTOR	12P
							CN1303	1-564-506-11	PLUG, CONNECTOR	3P
							CN1304	1-817-653-11	MEMORY STICK CONNECTOR	
								DIODE		
							D1306	8-719-800-76	DIODE	1SS226
							D1307	8-719-800-76	DIODE	1SS226
							D1308	8-719-800-76	DIODE	1SS226
							D1309	6-500-182-01	DIODE	L1503CB/D
							D1310	8-719-083-58	DIODE	UDZSTE-173.9B
							D1311	8-719-800-76	DIODE	1SS226
							D1312	8-719-914-43	DIODE	DAN202K
							D1313	8-719-914-44	DIODE	DAP202K
							D1314	8-719-977-28	DIODE	DTZ10B
								FERRITE BEAD		
							FB1302	1-414-229-11	FERRITE	0µH
							FB1303	1-414-229-11	FERRITE	0µH
							FB1304	1-414-229-11	FERRITE	0µH
							FB1305	1-414-229-11	FERRITE	0µH
							FB1306	1-400-089-21	FERRITE	0µH
							FB1307	1-414-229-11	FERRITE	0µH
							FB1308	1-414-229-11	FERRITE	0µH
							FB1309	1-414-229-11	FERRITE	0µH
							FB1310	1-414-229-11	FERRITE	0µH
							FB1311	1-414-229-11	FERRITE	0µH
							FB1312	1-414-921-11	FERRITE	0µH
							FB1313	1-414-229-11	FERRITE	0µH
							FB1315	1-400-089-21	FERRITE	0µH
								FILTER		
							FL1306	1-234-126-21	FERRITE	0µH
							FL1307	1-234-126-21	FERRITE	0µH
							FL1309	1-234-126-21	FERRITE	0µH
								IC		
							IC1302	6-704-819-01	IC CS4335-KSZR	
							IC1303	8-749-015-18	IC PQ07VZ012ZP	
							IC1304	8-749-015-18	IC PQ07VZ012ZP	
							IC1308	6-804-442-01	IC MBM29LV160BE90TN-E1-BA6L-ER	
							IC1310	6-706-283-01	IC ES6425FF	
							IC1311	6-706-452-01	IC IS42S16400B-7TL-TR	



REF. NO.	PART NO.	DESCRIPTION	VALUES			REF. NO.	PART NO.	DESCRIPTION	VALUES		
<u>COIL</u>					R1389	1-216-803-11	METAL CHIP	33	5%	1/10W	
L1301	1-469-549-21	INDUCTOR	1μH			R1391	1-216-797-11	METAL CHIP	10	5%	1/10W
L1302	1-469-549-21	INDUCTOR	1μH			R1397	1-216-813-11	METAL CHIP	220	5%	1/10W
L1303	1-469-549-21	INDUCTOR	1μH			R1398	1-216-864-11	SHORT CHIP			
L1304	1-469-549-21	INDUCTOR	1μH			R1399	1-216-864-11	SHORT CHIP			
<u>TRANSISTOR</u>					R1400	1-216-864-11	SHORT CHIP				
Q1301	8-729-424-02	TRANSISTOR	2SB709A-QRS-TX			R1401	1-216-864-11	SHORT CHIP			
Q1302	8-729-422-27	TRANSISTOR	2SD601A-Q			R1403	1-216-803-11	METAL CHIP	33	5%	1/10W
Q1303	8-729-424-02	TRANSISTOR	2SB709A-QRS-TX			R1404	1-216-803-11	METAL CHIP	33	5%	1/10W
Q1304	8-729-028-28	TRANSISTOR	2SK2036(TE85L)			R1408	1-216-803-11	METAL CHIP	33	5%	1/10W
Q1305	8-729-028-28	TRANSISTOR	2SK2036(TE85L)			R1409	1-216-803-11	METAL CHIP	33	5%	1/10W
<u>RESISTOR</u>					R1410	1-216-803-11	METAL CHIP	33	5%	1/10W	
R1307	1-218-285-11	METAL CHIP	75	5%	1/10W	R1411	1-216-803-11	METAL CHIP	33	5%	1/10W
R1308	1-218-285-11	METAL CHIP	75	5%	1/10W	R1415	1-216-813-11	METAL CHIP	220	5%	1/10W
R1309	1-218-285-11	METAL CHIP	75	5%	1/10W	R1420	1-216-803-11	METAL CHIP	33	5%	1/10W
R1310	1-218-659-11	METAL CHIP	43	0.50%	1/10W	R1421	1-216-803-11	METAL CHIP	33	5%	1/10W
R1314	1-216-829-11	METAL CHIP	4.7K	5%	1/10W	R1422	1-216-803-11	METAL CHIP	33	5%	1/10W
R1345	1-216-864-11	SHORT CHIP				R1423	1-216-803-11	METAL CHIP	33	5%	1/10W
R1348	1-216-864-11	SHORT CHIP				R1424	1-216-803-11	METAL CHIP	33	5%	1/10W
R1351	1-216-864-11	SHORT CHIP				R1426	1-216-829-11	METAL CHIP	4.7K	5%	1/10W
R1352	1-218-682-11	METAL CHIP	390	0.50%	1/10W	R1433	1-216-803-11	METAL CHIP	33	5%	1/10W
R1355	1-216-803-11	METAL CHIP	33	5%	1/10W	R1434	1-216-803-11	METAL CHIP	33	5%	1/10W
R1356	1-218-692-11	METAL CHIP	1K	0.50%	1/10W	R1435	1-216-818-11	METAL CHIP	560	5%	1/10W
R1357	1-216-803-11	METAL CHIP	33	5%	1/10W	R1436	1-216-818-11	METAL CHIP	560	5%	1/10W
R1358	1-216-864-11	SHORT CHIP				R1437	1-216-833-11	METAL CHIP	10K	5%	1/10W
R1359	1-218-672-11	METAL CHIP	150	0.50%	1/10W	R1438	1-216-833-11	METAL CHIP	10K	5%	1/10W
R1360	1-218-692-11	METAL CHIP	1K	0.50%	1/10W	R1439	1-216-850-11	METAL CHIP	270K	5%	1/10W
R1363	1-216-803-11	METAL CHIP	33	5%	1/10W	R1440	1-216-850-11	METAL CHIP	270K	5%	1/10W
R1366	1-216-864-11	SHORT CHIP				R1441	1-216-801-11	METAL CHIP	22	5%	1/10W
R1367	1-218-686-11	METAL CHIP	560	0.50%	1/10W	R1442	1-216-801-11	METAL CHIP	22	5%	1/10W
R1369	1-216-803-11	METAL CHIP	33	5%	1/10W	R1443	1-216-801-11	METAL CHIP	22	5%	1/10W
R1371	1-216-803-11	METAL CHIP	33	5%	1/10W	R1444	1-218-692-11	METAL CHIP	1K	0.50%	1/10W
R1372	1-218-696-11	METAL CHIP	1.5K	0.50%	1/10W	R1445	1-216-821-11	METAL CHIP	1K	5%	1/10W
R1374	1-216-803-11	METAL CHIP	33	5%	1/10W	R1446	1-216-809-11	METAL CHIP	100	5%	1/10W
R1375	1-216-829-11	METAL CHIP	4.7K	5%	1/10W	R1447	1-216-833-11	METAL CHIP	10K	5%	1/10W
R1376	1-216-829-11	METAL CHIP	4.7K	5%	1/10W	R1448	1-216-845-11	METAL CHIP	100K	5%	1/10W
R1379	1-216-829-11	METAL CHIP	4.7K	5%	1/10W	R1449	1-216-817-11	METAL CHIP	470	5%	1/10W
R1382	1-216-829-11	METAL CHIP	4.7K	5%	1/10W	R1450	1-216-841-11	METAL CHIP	47K	5%	1/10W
R1383	1-216-829-11	METAL CHIP	4.7K	5%	1/10W	R1451	1-216-841-11	METAL CHIP	47K	5%	1/10W
R1385	1-216-845-11	METAL CHIP	100K	5%	1/10W	R1453	1-216-833-11	METAL CHIP	10K	5%	1/10W
R1386	1-216-813-11	METAL CHIP	220	5%	1/10W	R1454	1-216-833-11	METAL CHIP	10K	5%	1/10W
R1387	1-216-803-11	METAL CHIP	33	5%	1/10W	R1455	1-216-809-11	METAL CHIP	100	5%	1/10W
						R1456	1-216-809-11	METAL CHIP	100	5%	1/10W
						R1457	1-216-864-11	SHORT CHIP			



REF. NO.	PART NO.	DESCRIPTION	VALUES	REF. NO.	PART NO.	DESCRIPTION	VALUES
R1458	1-216-864-11	SHORT CHIP					
R1459	1-216-864-11	SHORT CHIP					
R1460	1-216-864-11	SHORT CHIP					
R1461	1-216-803-11	METAL CHIP	33 5% 1/10W				
RESISTOR BRIDGE							
RB1404	1-233-574-11	RES, CHIP NETWORK	10 (3216)				
RB1405	1-233-574-11	RES, CHIP NETWORK	10 (3216)				
RB1406	1-233-574-11	RES, CHIP NETWORK	10 (3216)				
RB1407	1-233-574-11	RES, CHIP NETWORK	10 (3216)				
RB1408	1-233-574-11	RES, CHIP NETWORK	10 (3216)				
RB1409	1-233-574-11	RES, CHIP NETWORK	10 (3216)				
RB1410	1-233-574-11	RES, CHIP NETWORK	10 (3216)				
RB1411	1-234-524-21	RES, CHIP NETWORK	33 (3216)				
RB1412	1-234-524-21	RES, CHIP NETWORK	33 (3216)				
RB1413	1-234-524-21	RES, CHIP NETWORK	33 (3216)				
RB1414	1-234-524-21	RES, CHIP NETWORK	33 (3216)				
RB1415	1-234-524-21	RES, CHIP NETWORK	33 (3216)				
RB1416	1-234-524-21	RES, CHIP NETWORK	33 (3216)				
RB1417	1-234-524-21	RES, CHIP NETWORK	33 (3216)				
RB1418	1-234-524-21	RES, CHIP NETWORK	33 (3216)				
RB1419	1-234-524-21	RES, CHIP NETWORK	33 (3216)				
RB1420	1-234-524-21	RES, CHIP NETWORK	33 (3216)				
RB1421	1-234-524-21	RES, CHIP NETWORK	33 (3216)				
CRYSTAL							
X1301	1-795-502-21	VIBRATOR, CRYSTAL					
HR							
* A-1415-870-A HR BOARD, MOUNTED (KV-27FS320/32FS320/36FS320 ONLY)							
CAPACITOR							
C3001	1-104-665-11	ELECT	100µF 20% 25V				
CONNECTOR							
* CN3001	1-564-521-11	PLUG, CONNECTOR	6P				
DIODE							
D3002	8-719-057-09	DIODE	LNJ801LPDJA				
D3004	8-719-070-57	DIODE	PDZ5.6B-115				
IC							
IC3001	8-742-211-20	HYB IC	SBX3071-71				
RESISTOR							
R3001	1-249-417-11	CARBON	1K 5% 1/4W				
R3014	1-247-807-31	CARBON	100 5% 1/4W				
SWITCH							
S3006	1-786-338-12	SWITCH, TACTILE					
HU							
* A-1415-872-A HU BOARD, MOUNTED (KV-27FS320/32FS320/36FS320 ONLY)							
CAPACITOR							
C2234	1-137-194-81	FILM	0.47µF 5% 50V				
C2235	1-137-194-81	FILM	0.47µF 5% 50V				
CONNECTOR							
* CN1001	1-564-509-11	PLUG, CONNECTOR	6P				
DIODE							
D301	8-719-108-12	DIODE	RD9.1EW				
D2235	8-719-108-12	DIODE	RD9.1EW				
D2236	8-719-108-12	DIODE	RD9.1EW				
D2238	8-719-109-93	DIODE	RD6.2ESB2				
D2239	8-719-109-93	DIODE	RD6.2ESB2				
D2240	8-719-929-15	DIODE	HZS9.1NB2				
D2241	8-719-929-15	DIODE	HZS9.1NB2				
JACK							
J2231	1-794-048-11	JACK, PIN	3P				
RESISTOR							
R1001	1-249-427-11	CARBON	6.8K 5% 1/4W				
R1002	1-249-421-11	CARBON	2.2K 5% 1/4W				
R1003	1-249-419-11	CARBON	1.5K 5% 1/4W				
R2008	1-249-427-11	CARBON	6.8K 5% 1/4W				
R2009	1-249-421-11	CARBON	2.2K 5% 1/4W				
R2010	1-249-416-11	CARBON	820 5% 1/4W				
R2011	1-249-415-11	CARBON	680 5% 1/4W				
R2235	1-249-409-11	CARBON	220 5% 1/4W				
R2236	1-249-441-11	CARBON	100K 5% 1/4W				

HU HD HS

REF. NO.	PART NO.	DESCRIPTION	VALUES			REF. NO.	PART NO.	DESCRIPTION	VALUES				
R2237	1-249-409-11	CARBON	220	5%	1/4W	RESISTOR							
R2238	1-249-441-11	CARBON	100K	5%	1/4W	R1004	1-249-417-11	CARBON	1K	5%	1/4W		
R2240	1-247-804-11	CARBON	75	5%	1/4W	R1007	1-247-807-31	CARBON	100	5%	1/4W		
SWITCH						R1008	1-249-427-11	CARBON	6.8K	5%	1/4W		
S1007	1-762-816-11	SWITCH, TACTILE	R1009						1-249-421-11	CARBON	2.2K	5%	1/4W
S1008	1-762-816-11	SWITCH, TACTILE	R1010						1-249-416-11	CARBON	820	5%	1/4W
S2001	1-692-431-21	SWITCH, TACTILE	R1011						1-249-415-11	CARBON	680	5%	1/4W
S2002	1-692-431-21	SWITCH, TACTILE	R1201						1-249-419-11	CARBON	1.5K	5%	1/4W
S2003	1-692-431-21	SWITCH, TACTILE	R1202						1-249-421-11	CARBON	2.2K	5%	1/4W
S2004	1-692-431-21	SWITCH, TACTILE	R1203						1-249-427-11	CARBON	6.8K	5%	1/4W
S2005	1-692-431-21	SWITCH, TACTILE	R1234						1-247-804-11	CARBON	75	5%	1/4W
HD						R1235	1-249-409-11	CARBON	220	5%	1/4W		
* A-1415-873-A HD BOARD, MOUNTED (SPACER BOARD) (KV-27FS320/32FS320/36FS320 ONLY)						R1236	1-249-441-11	CARBON	100K	5%	1/4W		
HS						R1237	1-249-409-11	CARBON	220	5%	1/4W		
* A-1415-723-A HS BOARD, MOUNTED (KV-32FS120/34FS120/36FS120/38FS120 ONLY)						R1238	1-249-441-11	CARBON	100K	5%	1/4W		
CAPACITOR						SWITCH							
C1001	1-104-665-11	ELECT	100µF	20%	25V	S1001	1-692-431-21	SWITCH, TACTILE					
C1234	1-126-960-11	ELECT	1µF	20%	50V	S1002	1-692-431-21	SWITCH, TACTILE					
C1235	1-126-960-11	ELECT	1µF	20%	50V	S1003	1-692-431-21	SWITCH, TACTILE					
DIODE						S1004	1-692-431-21	SWITCH, TACTILE					
D1001	8-719-929-15	DIODE	HZS9.1NB2			S1005	1-692-431-21	SWITCH, TACTILE					
D1002	8-719-070-80	DIODE	LNK0120022G			S1006	1-692-431-21	SWITCH, TACTILE					
D1003	8-719-929-15	DIODE	HZS9.1NB2			S1007	1-762-816-11	SWITCH, TACTILE					
D1004	8-719-929-15	DIODE	HZS9.1NB2			S1008	1-762-816-11	SWITCH, TACTILE					
D1005	8-719-929-15	DIODE	HZS9.1NB2			ACCESSORIES AND PACKING							
D1233	8-719-108-12	DIODE	RD9.1EW			* 4-041-259-05	BAG, PROTECTION	(KV-27FS320 ONLY)					
D1235	8-719-108-12	DIODE	RD9.1EW			* 4-066-845-02	BAG, PROTECTION	(KV-32FS120/34FS120 ONLY)					
D1236	8-719-108-12	DIODE	RD9.1EW			* 4-066-646-02	BAG, PROTECTION	(KV-36FS120/38FS120 ONLY)					
IC						* 4-103-197-01	CARTON INDIVIDUAL	(KV-32FS120 ONLY)					
IC1001	8-742-212-20	HYB IC	SBX3081-71			* 4-103-489-01	CARTON, HSC	(KV-36FS320 ONLY)					
JACK						* 4-103-473-01	CARTON, INDIVIDUAL	(KV-27FS320 ONLY)					
J1231	1-794-048-11	JACK, PIN	3P			* 4-103-481-01	CARTON, INDIVIDUAL	(KV-32FS320 ONLY)					
						* 4-103-477-01	CARTON, INDIVIDUAL	(KV-34FS120 ONLY)					
						* 4-103-483-01	CARTON, INDIVIDUAL	(KV-36FS120 ONLY)					

REF. NO.	PART NO.	DESCRIPTION	VALUES	REF. NO.	PART NO.	DESCRIPTION	VALUES
*	4-103-485-01	CARTON, INDIVIDUAL (KV-38FS120 ONLY)		*	4-096-449-01	CUSHION, UPPER (KV-27FS320 ONLY)	
*	4-085-911-03	CUSHION, FRONT (UPPER) (KV-32FS320 ONLY)		*	4-088-740-01	CUSHION, UPPER (KV-32FS120/34FS120 ONLY)	
*	4-087-953-01	CUSHION, FRONT (UPPER) (KV-36FS120/38FS120 ONLY)		4-093-139-11	INSERT, DOOR BREAKAGE (L) (KV-27FS320/32FS320/36FS320 ONLY)		
*	4-086-352-02	CUSHION, FRONT (UPPER) (KV-36FS320 ONLY)		4-101-939-31	MANUAL, INSTRUCTION (KV-27FS32/32FS320/36FS320 CND ONLY)		
*	4-088-742-01	CUSHION, LOWER (KV-32FS120/34FS120 ONLY)		4-101-939-21	MANUAL, INSTRUCTION (KV-27FS320/32FS320/36FS320 US & HAWAII ONLY)		
*	4-085-913-02	CUSHION, LOWER (KV-32FS320 ONLY)		4-101-940-31	MANUAL, INSTRUCTION (KV-32FS120/36FS120 CND ONLY)		
*	4-087-955-01	CUSHION, LOWER (KV-36FS120/38FS120 ONLY)		4-101-940-21	MANUAL, INSTRUCTION (KV-32FS120/36FS120 US ONLY)		
*	4-086-354-03	CUSHION, LOWER (KV-36FS320 ONLY)		4-101-940-41	MANUAL, INSTRUCTION (KV-34FS120/38FS120 ONLY)		
*	4-088-741-01	CUSHION, REAR (UPPER) (KV-32FS120/34FS120 ONLY)		<u>REMOTE COMMANDER</u>			
*	4-085-912-02	CUSHION, REAR (UPPER) (KV-32FS320 ONLY)		1-478-707-11	REMOTE COMMANDER RM-Y195		
*	4-087-954-02	CUSHION, REAR (UPPER) (KV-36FS120/38FS120 ONLY)		4-978-977-11	BATTERY COVER (for RM-Y195) (KV-32FS120/34FS120/36FS120/38FS120 ONLY)		
*	4-086-353-03	CUSHION, REAR (UPPER) (KV-36FS320 ONLY)		1-478-708-11	REMOTE COMMANDER RM-Y196		
				4-978-977-11	BATTERY COVER (for RM-Y196) (KV-27FS320/32FS320/36FS320 ONLY)		

In an effort to reduce the size of this pdf file the tiled schematics are not attached to this Service Manual. To receive a complete set of the tiled schematics for this manual please submit a request to Nita Wardlaw at nita.wardlaw@am.sony.com.