

Projection TV



Operating Instructions

Wide Screen
1080i Capable
Digital Reality Creation
Multi Image Driver

KP-57XBR10W
KP-65XBR10W

WARNING

To prevent fire or shock hazard, do not expose the TV to rain or moisture.

CAUTION RISK OF ELECTRIC SHOCK DO NOT OPEN	
ATTENTION RISQUE DE CHOC ELECTRIQUE, NE PAS OUVRIR	
PRECAUCION RIESGO DE CHOQUE ELECTRICO NO ABRIR	
CAUTION : TO REDUCE THE RISK OF ELECTRIC SHOCK, DO NOT REMOVE COVER (OR BACK). NO USER-SERVICEABLE PARTS INSIDE. REFER SERVICING TO QUALIFIED SERVICE PERSONNEL.	



This symbol is intended to alert the user to the presence of uninsulated "dangerous voltage" within the product's enclosure that may be of sufficient magnitude to constitute a risk of electric shock to persons.



This symbol is intended to alert the user to the presence of important operating and maintenance (servicing) instructions in the literature accompanying the appliance.

CAUTION

To prevent electric shock, do not use this polarized AC plug with an extension cord, receptacle or other outlet unless the blades can be fully inserted to prevent blade exposure.

CAUTION

When using TV games, computers, and similar products with your projection TV, keep the brightness and contrast functions at low settings. If a fixed (non-moving) pattern is left on the screen for long periods of time especially at a high brightness or contrast setting, the image can be permanently imprinted onto the screen. These types of imprints are not covered by your warranty because they are the result of misuse.

Note on Caption Vision

This television receiver provides display of television closed captioning in accordance with §15.119 of the FCC rules.

Note on convergence adjustment

Before you use your projection TV, make sure to adjust convergence. For details, see on page 25.

Note to CATV system installer

This reminder is provided to call the CATV system installer's attention to Article 820-40 of the NEC that provides guidelines for proper grounding and, in particular, specifies that the cable ground shall be connected to the grounding system of the building, as close to the point of cable entry as practical.

Use of this television receiver for other than private viewing of programs broadcast on UHF or VHF or transmitted by cable companies for the use of the general public may require authorization from the broadcaster/cable company and/or program owner.

NOTIFICATION

This equipment has been tested and found to comply with the limits for a Class B digital device pursuant to Part 15 of the FCC Rules. These limits are designed to provide reasonable protection against harmful interference in a residential installation. This equipment generates, uses, and can radiate radio frequency energy and, if not installed and used in accordance with the instructions, may cause harmful interference with radio communications. However, there is no guarantee that interference will not occur in a particular installation. If this equipment does cause harmful interference to radio or television reception, which can be determined by turning the equipment off and on, the user is encouraged to try to correct the interference by one or more of the following measures:

- Reorient or relocate the receiving antennas.
- Increase the separation between the equipment and receiver.
- Connect the equipment into an outlet on a circuit different from that to which the receiver is connected.
- Consult the dealer or an experienced radio/TV technician for help.

You are cautioned that any changes or modifications not expressly approved in this manual could void your authority to operate this equipment.

This document is for the remote control RM-Y907
MODELS: KP-57XBR10W, KP-65XBR10W

Please keep this notice with the instruction manual.



As an ENERGY STAR Partner, Sony Corporation has determined that this product meets the ENERGY STAR guidelines for energy efficiency.

ATTENTION

Pour prévenir les chocs électriques, ne pas utiliser cette fiche polarisée avec un prolongateur, une prise de courant ou une autre sortie de courant, sauf si les lames peuvent être insérées à fond sans en laisser aucune partie à découvert.

Owner's Record

The model and serial numbers are located at the rear of the projection TV, below the Sony logo, on the sticker, and also on the TV box (white label). Record these numbers in the spaces provided below. Refer to them whenever you call upon your Sony dealer regarding this product.

Model No. _____

Serial No. _____

Remote Control



In the instructions that follow, we will refer to the buttons on your remote control.

Keep this flap unfolded and use this page for reference.

For a detailed explanation of most buttons, see "Watching the TV" on page 26.

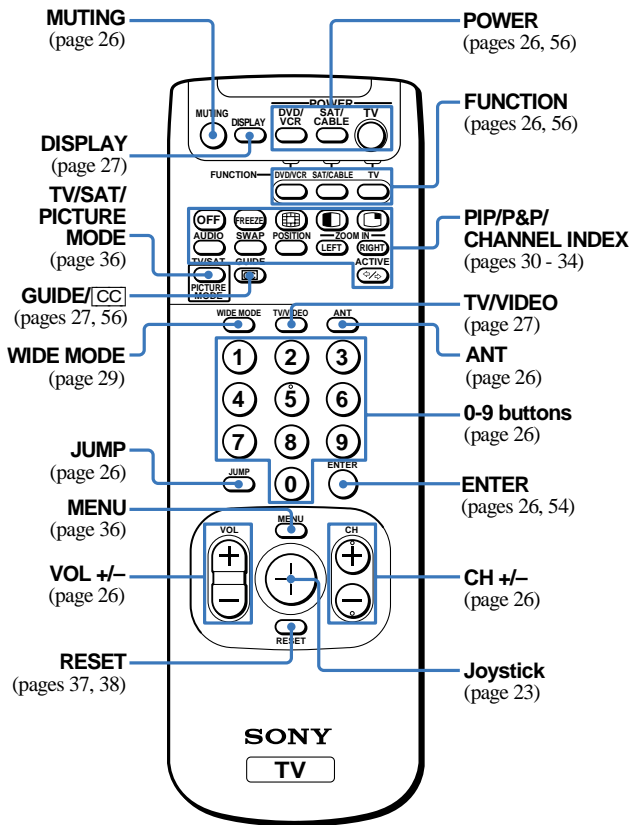
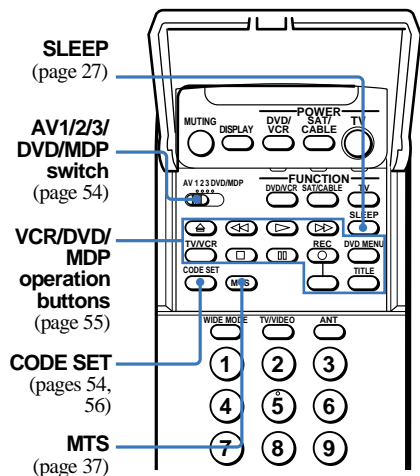

Getting to know the buttons on the remote control

Names of the buttons on the remote control are presented in different colors to represent the available functions.

- Button color**
- Black:** Press to select the component you want to control; e.g. VCR/MDP/DVD Player, SAT/CABLE, or projection TV.
- Green:** Buttons relevant to power operations, like turning the projection TV, SAT/CABLE, or VCR/MDP/DVD Player on or off
- Label color**
- White:** TV/VCR/MDP/DVD Player/SAT/CABLE operation buttons
- Yellow:** PIP, P&P, and CHANNEL INDEX operation buttons
- Blue:** SAT operation buttons
- Pink:** DVD Player operation buttons

Table of Contents

Before You Begin

Welcome!	1
Using this Manual	2
Precautions.....	2
Important Safeguards	3

Installing and Connecting the Projection TV

Carrying Your Projection TV.....	6
Installing the Projection TV	6
Mounting the Rear Speakers (not supplied) ..	6
Connector Types	7
Making Connections	8
Connecting Directly to a Cable or an Antenna	8
Connecting a Cable Box	9
Connecting an Antenna/Cable TV System to a VCR	10
Connecting a VCR and Projection TV to a Cable Box	11
Connecting a DTV (Digital Television) Receiver	12
Connecting a Satellite Receiver (SAT)	14

Connecting a Satellite Receiver (SAT) and VCR	15
Connecting a Camcorder	16
Connecting Two VCRs for Tape Editing	17
Connecting a DVD Player With S Video or Composite Video Output Connectors	18
Connecting a DVD Player With Component Video Output Connectors	19
Connecting an AV Receiver	20
Connecting an Audio System	21
Connecting an Amplifier That Supports Dolby Pro Logic Decoder	22

Basic Set Up







Using the Remote Control.....	23
Setting Up the Projection TV Automatically	24
Adjusting the Convergence Automatically (FLASH FOCUS)	25

Using Your New Projection TV

Watching the TV.....	26
Watching Digital TV.....	28
Watching the Picture in Wide Screen Mode Automatically — AUTO WIDE	28

Watching the Picture in Wide Screen Mode Manually — WIDE MODE.....	29
Watching Two Programs at One Time — PIP.....	30
Watching Two Programs at One Time — P&P (Twin View™).....	32
Using CHANNEL INDEX	33

Adjusting Your SET UP (menus)

Learning Menu Selection.....	35
 Using the VIDEO Menu	36
 Using the AUDIO Menu	37
Adjusting the Speaker Volume for Customized Surround Mode	38
 Using the TIMER Menu	39
 Using the WIDE SCREEN MODE Menu	40
 Using the CHANNEL SET UP Menu ..	41
Setting and Selecting FAVORITE CHANNEL	42
Setting FAVORITE CHANNEL manually	43
Resetting FAVORITE CHANNEL choices	43
Using FAVORITE CHANNEL	44
 Using the SET UP Menu	44
Using the PARENTAL CONTROL Feature	47

Activating the PARENTAL CONTROL feature	47
Selecting a Custom Rating	49
Changing the Password	51
What the Ratings Mean	52

Additional Operations

Operating Video Equipment.	54
Setting the Manufacturer's Code ...	54
Operating video equipment	55
Operating a Cable Box or Satellite Receiver (SAT)	56
Setting the Manufacturer's Code ...	56
Operating a cable box or satellite receiver	56

Additional Information

Troubleshooting	57
Specifications	60
Index	61

* Manufactured under license from Dolby Laboratories Licensing Corporation. Additionally licensed under Canadian patent number 1,037,877. "Dolby," the double-D symbol  and "Pro Logic" are trademarks of Dolby Laboratories Licensing Corporation

Before You Begin

Welcome!

Thank you for purchasing the Sony Projection TV. This manual is for models KP-57XBR10W and KP-65XBR10W.

Model KP-57XBR10W is used for illustration purposes.

The features you will enjoy include:

- "1080i Capable," enabling you to receive the 1080i, 720p, 480p and 480i digital TV formats. By using the VIDEO 5 (DTV) IN jacks, you can connect a DTV (digital television) receiver to view DTV programs. The VIDEO 5 (DTV) IN jacks also function as R/G/B connectors with SYNC signal (HD/VD), but are not compatible with a computer's 5BNC video output connectors.
- WIDE SCREEN MODE, allowing you to watch 4:3 normal broadcasts in wide screen mode (16:9 aspect ratio).
- AUTO WIDE, allowing you to select the wide screen mode automatically.
- PARENTAL CONTROL, enabling you to block programs that are unsuitable for your children.
- DRC (Digital Reality Creation), a technology unique to Sony, allowing you to obtain a finer, more detailed picture with four-times higher density than the conventional NTSC picture. (not available for input from the VIDEO 5 (DTV) IN jacks)

- MID (Multi Image Driver), a newly developed device, allowing you to enjoy the following features and, at the same time, to use your projection TV easily. (not available for input from the VIDEO 5 (DTV) IN jacks)
 - Picture & Picture (P&P) with zoom-in function (Twin View™)
 - Picture-in-Picture (PIP)
 - CHANNEL INDEX, allowing you to view and choose from twelve programs
 - FAVORITE CHANNEL, allowing you to view and choose from eight of your favorite channels
- FLASH FOCUS, allowing you to adjust convergence automatically.
- Two Y/Pb/Pr inputs for DVD Player connection (480p format capability is on the VIDEO 5 (DTV) IN jacks).
- Four AUDIO/VIDEO/S VIDEO inputs.

Using this Manual

We recommend that you carefully review the contents of the following four sections in the order provided to ensure that you fully understand the operation of your new projection TV.

1 Installing and Connecting the Projection TV

This section guides you through your initial set up. It shows you how to install your projection TV, to connect your new components and to connect to the antenna and cable.

2 Basic Setup

This section teaches you the basic skills needed to operate your new projection TV, including Easy Set Up. It shows you how to operate the remote control's special functions.

3 Using Your New Projection TV

This section shows you how to begin using your new projection TV. It shows you how to use your remote control's features.

4 Adjusting Your Set Up (menus)

This section teaches you how to access on-screen menus and adjust your projection TV's settings.

Instructions in this manual are written for the remote control. Similar controls may be found on the projection TV console.

Precautions

Safety

- Operate the projection TV only on 120 V AC.
- The plug is designed, for safety purposes, to fit into the wall outlet only one way. If you are unable to insert the plug fully into the outlet, contact your dealer.
- If any liquid or solid object should fall inside the cabinet, unplug the projection TV immediately and have it checked by qualified service personnel before operating it further.
- If you will not be using the projection TV for several days, disconnect the power by pulling the plug itself. Never pull on the cord.

For details concerning safety precautions, see "Important Safeguards" on page 3.

Note on cleaning

Clean the cabinet of the projection TV with a dry soft cloth. To remove dust from the screen, wipe it gently with a soft cloth. Stubborn stains may be removed with a cloth slightly dampened with solution of mild soap and warm water. Never use strong solvents such as thinner or benzine for cleaning.

If the picture becomes dark after using the projection TV for a long period of time, it may be necessary to clean the inside of the projection TV. Consult qualified service personnel.

Installing

- To prevent internal heat buildup, do not block the ventilation openings.
- Do not install the projection TV in a hot or humid place, or in a place subject to excessive dust or mechanical vibration.
- Avoid operating the projection TV at temperature below 5°C (41°F).
- If the projection TV is transported directly from a cold to a warm location, or if the room temperature changes suddenly, the picture may be blurred or show poor color. In this case, please wait a few hours to let the moisture evaporate before turning on the projection TV.
- To obtain the best picture, do not expose the screen to direct illumination or direct sunlight. It is recommended to use spot lighting directed down from the ceiling or to cover the windows that face the screen with opaque drapery. It is desirable to install the projection TV in a room where the floor and walls are not of a reflective material.

Important Safeguards

For your protection, please read these instructions completely, and keep this manual for future reference.

Carefully observe and comply with all warnings, cautions and instructions placed on the set, or described in the operating instructions or service manual.

WARNING

To guard against injury, the following basic safety precautions should be observed in the installation, use, and servicing of the set.

Use



Power Sources

This set should be operated only from the type of power source indicated on the serial/model plate.

If you are not sure of the type of electrical power supplied to your home, consult your dealer or local power company. For those sets designed to operate from battery power, refer to the operating instructions.

Grounding or Polarization

This set is equipped with a polarized AC power cord plug (a plug having one blade wider than the other), or with a three-wire grounding type plug (a plug having a third pin for grounding).

Follow the instructions below:



For the set with a polarized AC power cord plug

This plug will fit into the power outlet only one way. This is a safety feature. If you are unable to insert the plug fully into the outlet, try reversing the plug. If the plug should still fail to fit, contact your electrician to have a suitable outlet installed. Do not defeat the safety purpose of the polarized plug by forcing it in.

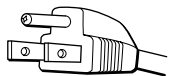

Alternate Warning For the set with a three-wire grounding type AC plug

This plug will only fit into a grounding-type power outlet. This is a safety feature. If you are unable to insert the plug into the outlet, contact your electrician to have a suitable outlet installed. Do not defeat the safety purpose of the grounding plug.



Overloading

Do not overload wall outlets, extension cords or convenience receptacles beyond their capacity, since this can result in fire or electric shock.

Always turn the set off when it is not to be used. When the set is left unattended and unused for long periods of time, unplug it from the wall outlet as a precaution against



the possibility of an internal malfunction that could create a fire hazard.

Object and Liquid Entry

Never push objects of any kind into the set through the cabinet slots as they may touch dangerous voltage points or short out parts that could result in a fire or electric shock. Never spill liquid of any kind on the set.



Attachments

Do not use attachments not recommended by the manufacturer, as they may cause hazards.



Cleaning

Unplug the set from the wall outlet before cleaning or polishing it. Do not use liquid cleaners or aerosol cleaners. Use a cloth lightly dampened with water for cleaning the exterior of the set.



(continued)

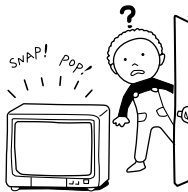

If a snapping or popping sound from a projection TV set is continuous or frequent while the projection TV is operating, unplug the projection TV and consult your dealer or service technician. It is normal for some projection TV sets to make occasional snapping or popping sounds, particularly when being turned on or off.

Installation



Water and Moisture
Do not use power-line operated sets near water—for example, near a bathtub, washbowl, kitchen sink, or laundry tub, in a wet basement or near a swimming pool, etc.

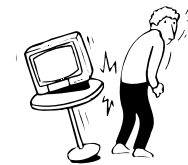

Accessories
Do not place the set on an unstable cart, stand, table or shelf. The set may fall, causing serious injury to a child or an adult, and serious damage to the set. Use only a cart or stand recommended by the manufacturer for the specific model of projection TV.



An appliance and cart combination should be moved with care. Quick stops, excessive force, and uneven surfaces may cause the appliance and cart combination to overturn.

Ventilation

The slots and openings in the cabinet and in the back or bottom are provided for necessary ventilation. To ensure reliable operation of the set, and to protect it from overheating, these slots and openings must never be blocked or covered.

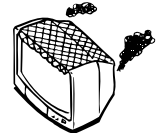

- Never cover the slots and openings with a cloth or other materials.

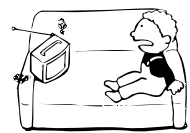

- Never block the slots and openings by placing the set on a bed, sofa, rug or other similar surface.

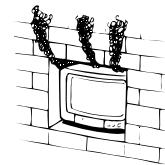

- Never place the set in a confined space, such as a bookcase, or built-in cabinet unless proper ventilation is provided.



- Do not place the set near or over a radiator or heat register, or where it is exposed to direct sunlight.



Power-Cord Protection
Do not allow anything to rest on or roll over the power cord, and do not place the set where the power cord is subject to wear or abuse.

Antennas

Outdoor Antenna Grounding — If an outdoor antenna is installed, follow the precautions below.

An outdoor antenna system should not be located in the vicinity of overhead power lines or other electric light or power circuits, or where it can come in contact with such power lines or circuits.

WHEN INSTALLING AN OUTDOOR ANTENNA SYSTEM, EXTREME CARE SHOULD BE TAKEN TO KEEP FROM CONTACTING SUCH POWER LINES OR CIRCUITS AS CONTACT WITH THEM IS ALMOST INVARIABLY FATAL.

Be sure the antenna system is grounded so as to provide some protection against voltage surges and built-up static charges.

Section 810 of the National Electrical Code (NEC) in USA and Section 54 of the Canadian Electrical Code in Canada provides information with respect to proper grounding of the mast and supporting structure, grounding of the lead-in wire to an antenna discharge unit, size of grounding conductors, location of antenna discharge unit, connection to grounding electrodes, and requirements for the grounding electrode.

Antenna Grounding According to the NEC

— Refer to section 54-300 of Canadian Electrical Code for Antenna Grounding.

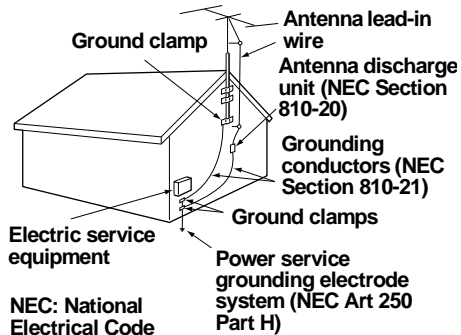

Lightning

For added protection for this television receiver during a lightning storm, or when it is left unattended and unused for long periods of time, unplug it from the wall outlet and disconnect the antenna. This will prevent damage to the receiver due to lightning and power-line surges.

Service

Damage Requiring Service

Unplug the set from the wall outlet and refer servicing to qualified service personnel under the following conditions:



- When the power cord or plug is damaged or frayed.



- If liquid has been spilled into the set.



- If the set has been exposed to rain or water.



- If the set has been subject to excessive shock by being dropped, or the cabinet has been damaged.



- If the set does not operate normally when following the operating instructions. Adjust only those controls that are specified in the operating instructions.

Improper adjustment of other controls may result in damage and will often require extensive work by a qualified technician to restore the set to normal operation.

- When the set exhibits a distinct change in performance—this indicates a need for service.



Servicing

Do not attempt to service the set yourself since opening the cabinet may expose you to dangerous voltage or other

hazards. Refer all servicing to qualified service personnel.

Replacement Parts

When replacement parts are required, be sure the service technician certifies in writing that he has used replacement parts specified by the manufacturer that have the same characteristics as the original parts.

Unauthorized substitutions may result in fire, electric shock, or other hazards.

Safety Check



Upon completion of any service or repairs to the set, ask the service technician to perform routine safety checks (as specified by the manufacturer) to determine that the set is in safe operating condition, and to so certify.



When the set reaches the end of its useful life, improper disposal could result in a picture tube implosion. Ask a qualified service technician to dispose of the set.

Installing and Connecting the Projection TV

Carrying Your Projection TV

Carrying the projection TV requires three or more people.

The projection TV has been equipped with casters for easy movement on a hard surface. Please move your projection TV using the casters.

Installing the Projection TV

Recommended viewing area (Horizontal)

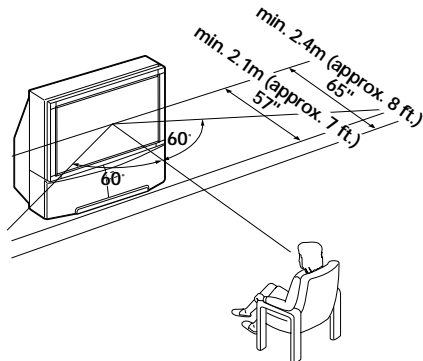

Recommended viewing area (Vertical)

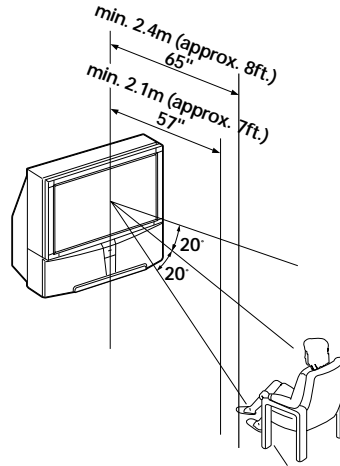

Mounting the Rear Speakers (not supplied)

For enhanced surround effect, connect the rear speakers to your projection TV.

Connecting the rear speakers

Using the speaker cords, connect REAR SPEAKER OUT L on your projection TV to the speaker terminal on one rear speaker, and connect

REAR SPEAKER OUT R to the terminal on the other one.

Note:

- When you use a speaker other than one that we recommend, use a speaker with maximum input power of more than 20 W and impedance of 8 ohms.

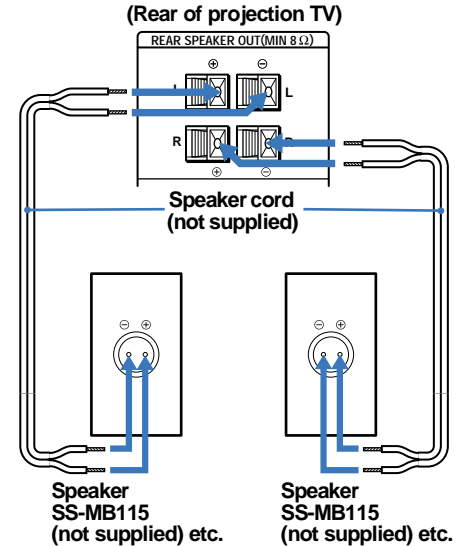

Installation

For optimum surround effect, mount the rear speakers in the following places (as shown in the illustration):

- on a wall, as high as the listener's ears.
- on a table, as high as the listener's ears.

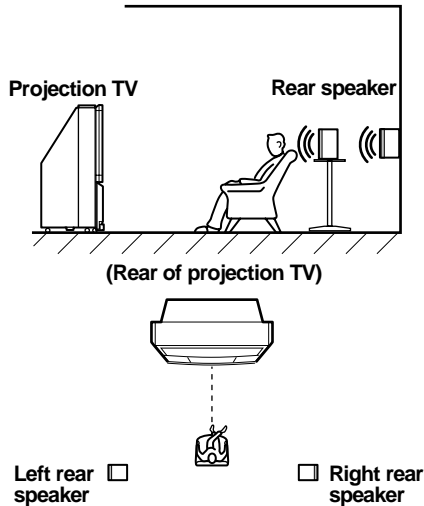

Connector Types

You may find it necessary to use some of the following connector types during set up.

Coaxial cable

Standard TV cable and antenna cable

Plug Type



Screw-on Type



S Video cable

High quality video cable for enhanced picture quality



Audio/Video cable



Video - Yellow
Audio (Left) - White
Audio (Right) - Red

Some DVD Players are equipped with the following three video connectors.

Y - Green
PB (CB, Cb or B-Y) - Blue
PR (CR, Cr or R-Y) - Red

Component video cable for a DTV receiver



G/Y - Green
B/P_B - Blue
R/P_R - Red
HD - Gray
VD - Black

CONTROL S cable

Sony cable for CONTROL S connections. These features are exclusive to Sony products and allow greater control of all Sony equipment.



(continued)

About the CONTROL S IN/OUT jacks

To control other Sony equipment with the projection TV's remote control, connect the CONTROL S IN jack of the equipment to the CONTROL S OUT jack on the projection TV with the CONTROL S cable.

To control the projection TV with a remote control for another Sony product, connect the CONTROL S OUT jack of the equipment to the CONTROL S IN jack on the projection TV with the CONTROL S cable.

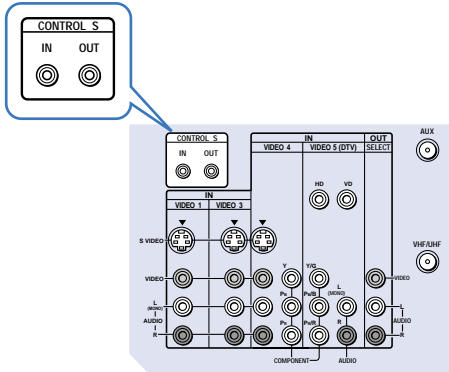

Making Connections

Connecting Directly to a Cable or an Antenna

The connection you choose will depend on the cable found in your home. Newer homes will be equipped with standard coaxial cable (see A); older homes will probably have 300-ohm twin lead cable (see B); still other homes may contain both (see C).

A

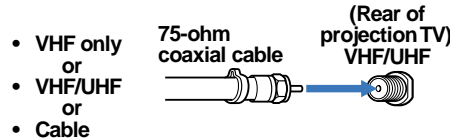

B

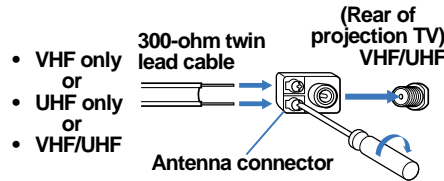

C

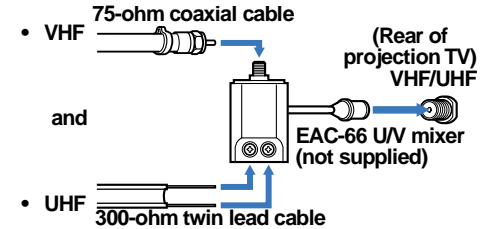

Cable or antenna

This is the simplest connection. Connection is made directly from the cable or antenna to the projection TV.

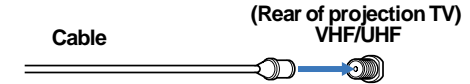

Cable and antenna

You may find it convenient to use the following set up if your cable provider does not feature local channels that you are able to receive using an antenna.

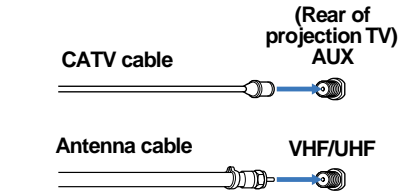

Select Cable or ANT mode by pressing ANT on the remote control.

Connecting a Cable Box

Some pay cable TV systems use scrambled or encoded signals that require a cable box* to view all channels.

Also, set CABLE to ON in the CHANNEL SET UP menu. (see page 41)

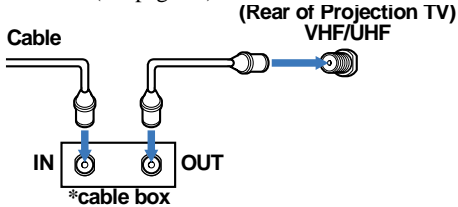

Note:

- If you will be controlling all channel selection through your cable box, you should consider using the CHANNEL FIX feature. (see “CHANNEL FIX” on page 42)

Cable box and cable

Some pay cable TV systems use scrambled or encoded signals requiring a cable box* only for certain channels (e.g. HBO, SHOWTIME, etc.)

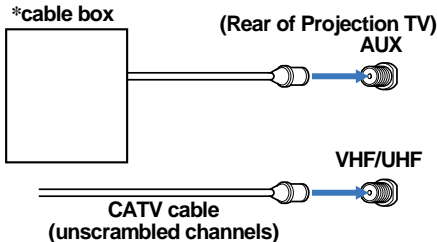

For this set up, you can switch between scrambled channels (through your cable box), and normal (CATV) channels by pressing ANT on your remote control.

Notes:

- You may be able to program your Sony remote control to operate your cable box. (see “Operating a Cable Box or Satellite Receiver (SAT)” on page 56)
- During PIP, P&P, CHANNEL INDEX or FAVORITE CHANNEL viewing, the AUX input can only be viewed in the main picture.
- If you are connecting a cable box through the AUX input and would like to switch between the AUX and normal (CATV) input, you should consider using CHANNEL FIX. (see “CHANNEL FIX” on page 42)

Connecting an Antenna/Cable TV System to a VCR

- 1 Attach the coaxial cable from the incoming cable connection or antenna to IN on the VCR.
- 2 Using a coaxial cable, connect OUT on the VCR to VHF/UHF on the projection TV.
- 3 Using AUDIO and S VIDEO* cables, connect AUDIO and S VIDEO OUT on the VCR to AUDIO and S VIDEO IN on the projection TV (White-AUDIO Left, Red-AUDIO Right).

* If your VCR is not equipped with S VIDEO, use a VIDEO cable (yellow) instead of the S VIDEO cable.

Note:

- If you are connecting a monaural VCR, connect only the single audio output to the left (MONO) input on the projection TV.

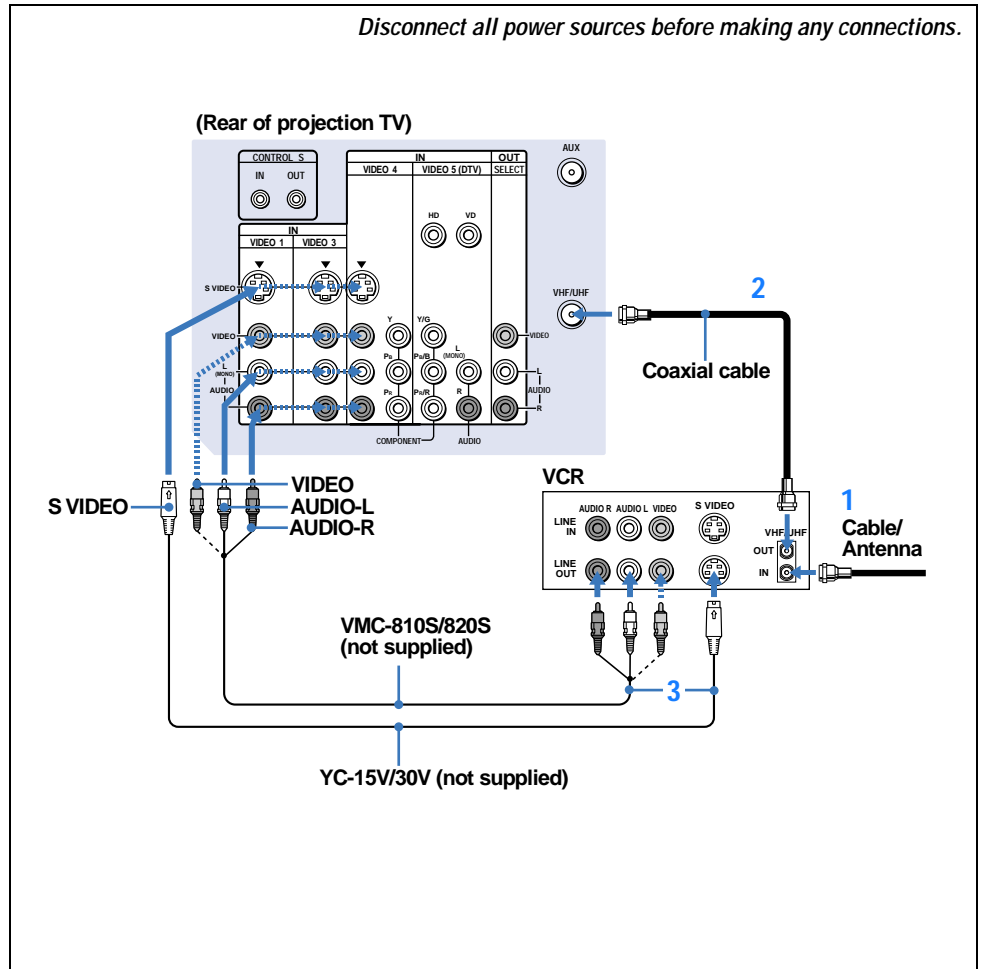

Connecting a VCR and Projection TV to a Cable Box

- 1 Connect the single (input) jack of the splitter to the incoming cable connection, and connect the other two (output) jacks (using the coaxial cable) to IN on the cable box and VHF/UHF on the projection TV.
- 2 Using a coaxial cable, connect OUT on the cable box to IN on the VCR.
- 3 Using AUDIO and S VIDEO* cables, connect AUDIO and S VIDEO OUT on the VCR to AUDIO and S VIDEO IN on the projection TV (White-AUDIO Left, Red-AUDIO Right).

* If your VCR is not equipped with S VIDEO, use a VIDEO cable (yellow) instead of the S VIDEO cable.

Note:

- To view scrambled channels through the cable box, select the video input which the cable box is connected to by pressing TV/VIDEO.

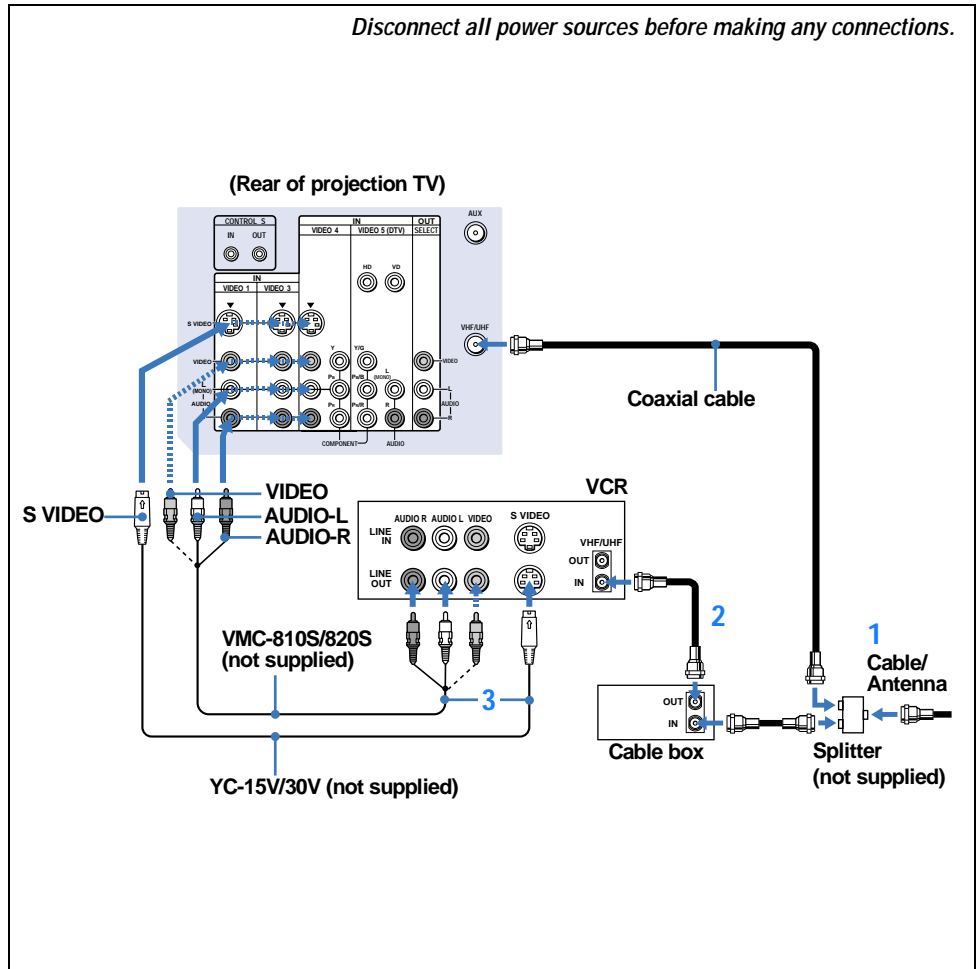

Connecting a DTV (Digital Television) Receiver

Before connecting, be sure to read the Operating Instructions of the DTV receiver.

Connecting a DTV (digital television) receiver with the Y/Pb/Pr (component video input) jacks

- 1 Attach the coaxial cable from the roof antenna to VHF/UHF on the DTV receiver.
- 2 Using three VIDEO cables, connect Y, Pb and Pr of COMPONENT VIDEO OUT on the DTV receiver to Y, Pb and Pr of VIDEO 5 (DTV) IN on the projection TV.
- 3 Using an AUDIO cable, connect LINE OUT on the DTV receiver to AUDIO of VIDEO 5 (DTV) IN on the projection TV (White-AUDIO Left, Red-AUDIO Right).
- 4 Select VIDEO 5 by the TV/VIDEO button.
- 5 Select the SET UP menu and set DTV INPUT to Y PB PR. (see "DTV INPUT" on page 47)

Note:

- Some DTV receiver terminals may be labeled differently. If so, connect as follows:
Connect Y (green) to Y.
Connect Pb (blue) to Cb, Cb or B-Y.
Connect Pr (red) to Cr, Cr or R-Y.

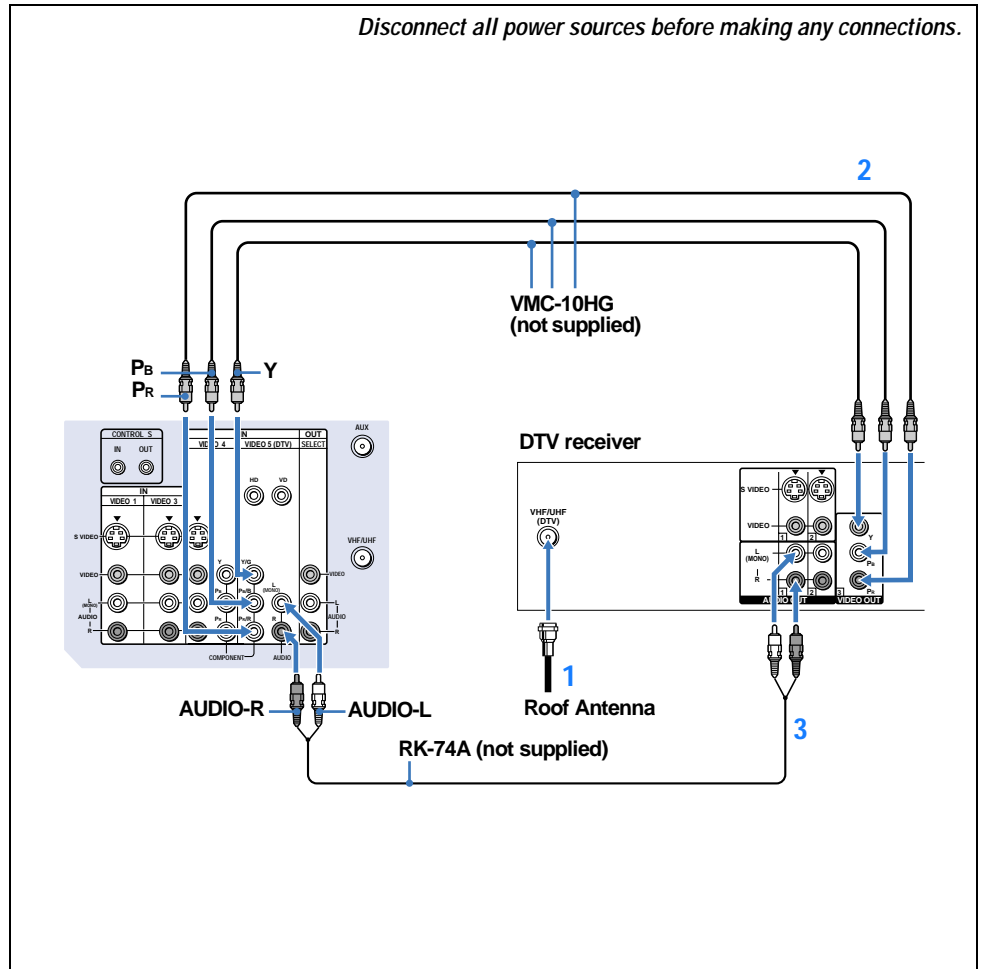

Connecting a DTV (digital television) receiver with the G/B/R/ HD/VD jacks

- 1 Attach the coaxial cable from the roof antenna to VHF/UHF on the DTV receiver.
- 2 Using a component video cable for DTV receiver, connect G, B, R, HD and VD of VIDEO OUT on the DTV receiver to G, B, R, HD and VD respectively of VIDEO 5 (DTV) IN on the projection TV.
If the DTV receiver is equipped with the Y/Pb/Pr jacks, proceed to step 2 in "Connecting a DTV (digital television) receiver with the Y/Pb/Pr (component video input) jacks on page 12.
- 3 Using an AUDIO cable, connect AUDIO OUT on the DTV receiver to AUDIO of VIDEO 5 (DTV) IN on the projection TV (White-AUDIO Left, Red-AUDIO Right).
- 4 Select VIDEO 5 by the TV/VIDEO button.
- 5 Select the SET menu and set DTV INPUT to R.G.B. (see "DTV INPUT" on page 47)

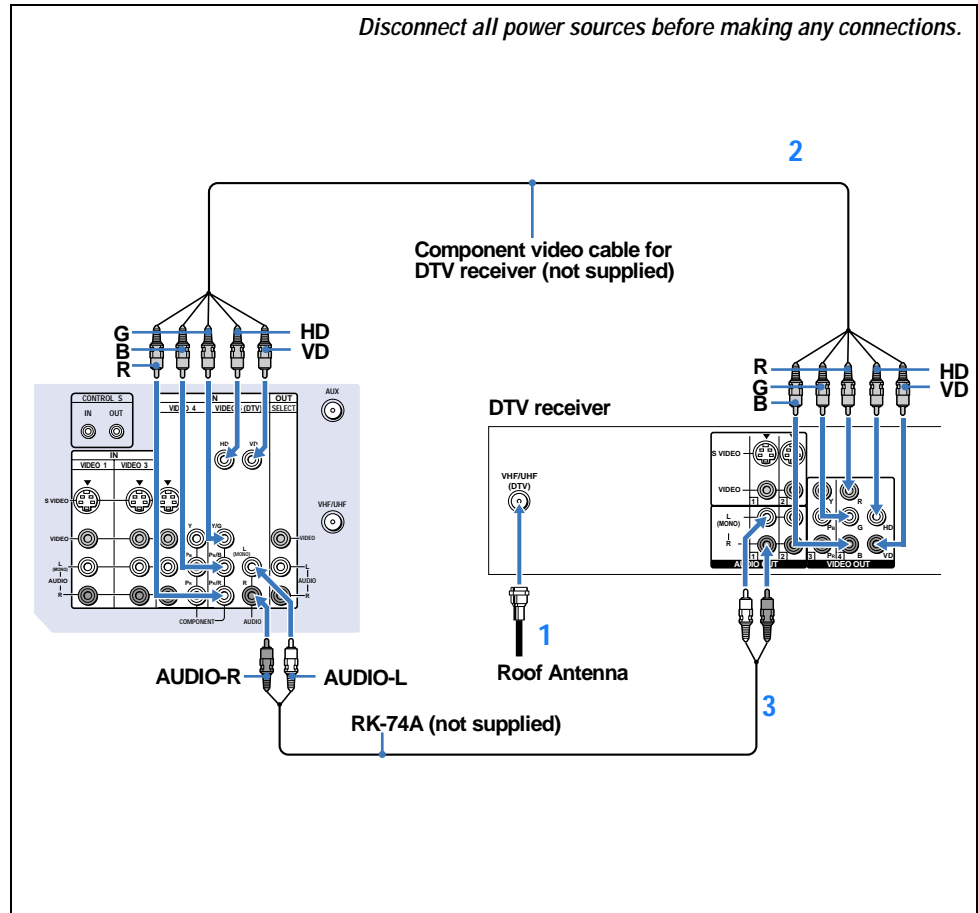

Connecting a Satellite Receiver (SAT)

- 1 Connect the cable from the satellite antenna to the satellite receiver.
- 2 Attach the coaxial cable from the incoming cable connection or antenna to VHF/UHF on the projection TV.
- 3 Using AUDIO and S VIDEO cables, connect AUDIO and S VIDEO OUT on the satellite receiver to AUDIO and S VIDEO IN on the projection TV (White-AUDIO Left, Red-AUDIO Right).

Note:

- To view input from the satellite receiver, select the video input which the satellite receiver is connected to by pressing TV/VIDEO on the remote control.

Disconnect all power sources before making any connections.

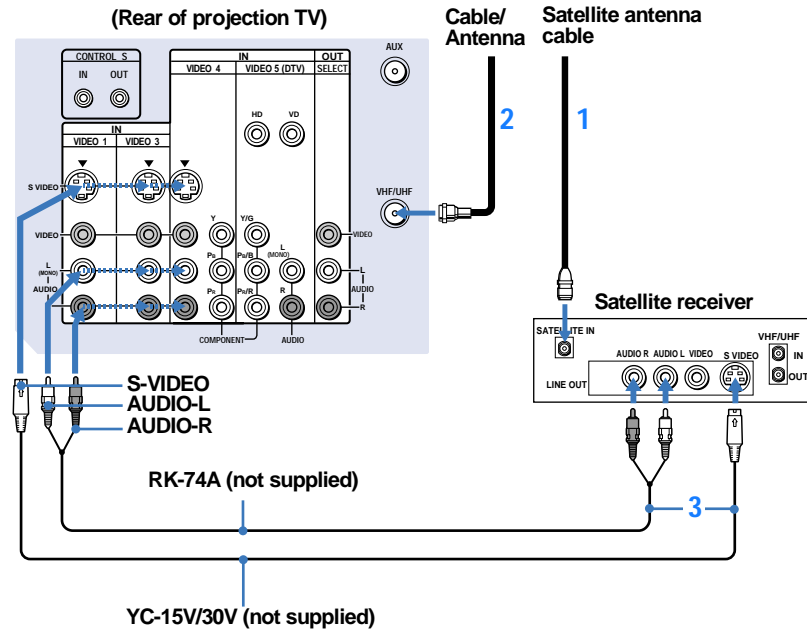

Connecting a Satellite Receiver (SAT) and VCR

- 1 Connect the cable from the satellite antenna to the satellite receiver.
- 2 Attach the coaxial cable from the incoming cable connection or antenna to VHF/UHF IN on the VCR.
- 3 Using a coaxial cable, connect VHF/UHF OUT on the VCR to VHF/UHF on the projection TV.
- 4 Using AUDIO and S VIDEO* cables, connect AUDIO and S VIDEO OUT on the satellite receiver to AUDIO and S VIDEO IN on the VCR.
- 5 Using AUDIO and S VIDEO* cables, connect AUDIO and S VIDEO OUT on the VCR to AUDIO and S VIDEO IN on the projection TV (White-AUDIO Left, Red-AUDIO Right).

* If your VCR or satellite receiver is not equipped with S VIDEO, use a VIDEO cable (yellow) instead of the S VIDEO cable.

Note:

- To view input from the satellite receiver or VCR, select the video input which your satellite receiver or VCR is connected to by pressing TV/VIDEO on the remote control.

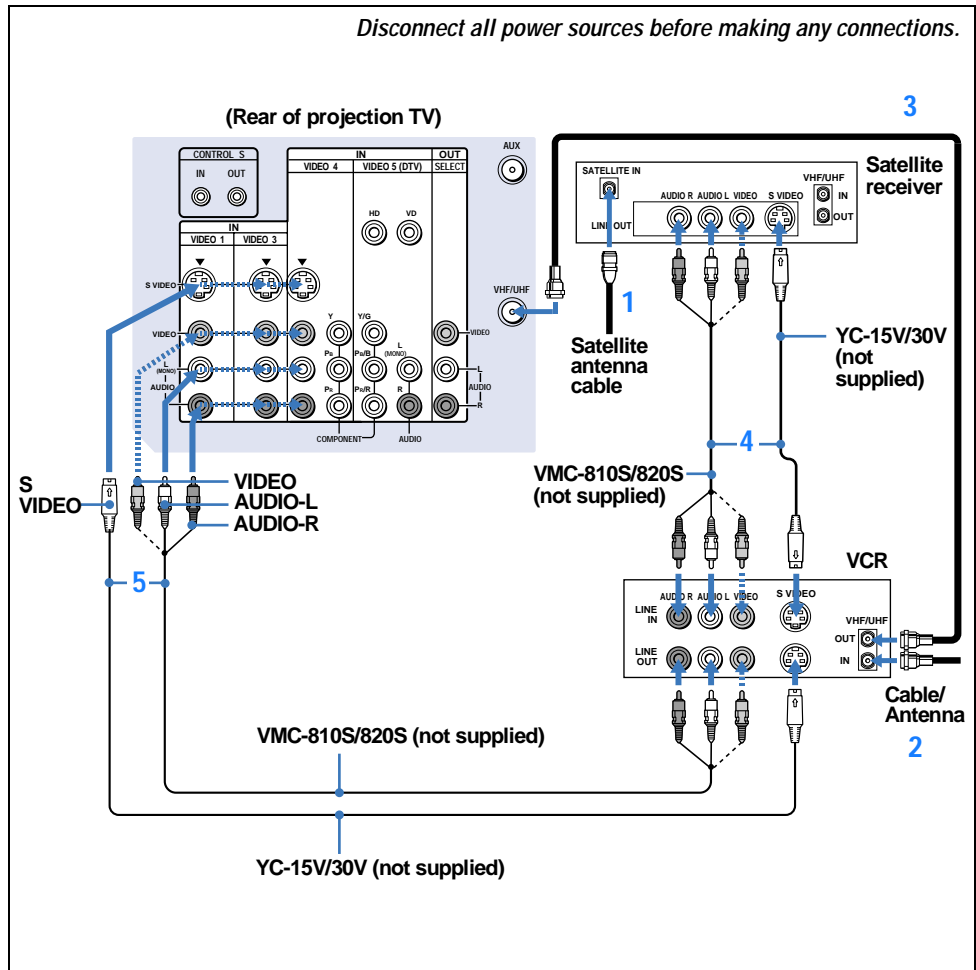

Connecting a Camcorder

Use this connection to view a picture directly from your camcorder.

- 1 Using AUDIO and S VIDEO* cables, connect AUDIO and S VIDEO OUT on the camcorder to AUDIO and S VIDEO IN on the right side panel inside the drop-down panel on the front of the projection TV (White-AUDIO Left, Red-AUDIO Right**).
- 2 Press VIDEO 2 to select the video inputs from a camcorder.

* If your camcorder is not equipped with S VIDEO, use a VIDEO cable (yellow) instead of the S VIDEO cable.

**If you are connecting a monaural camcorder, connect only the single audio output to the left (MONO) input on the projection TV.

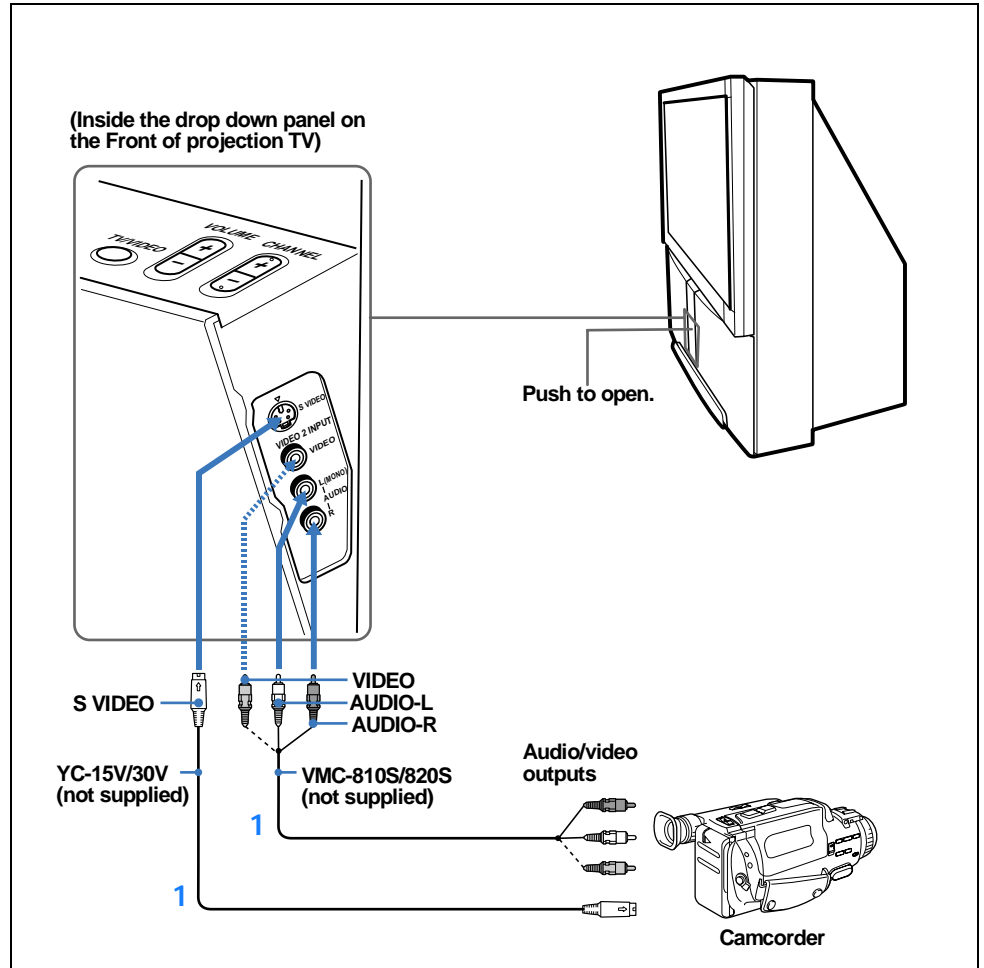

Connecting Two VCRs for Tape Editing

SELECT OUT allows you to use a second VCR to record a program being played by the primary VCR or to perform tape editing and dubbing.

- 1 Connect the VCR intended for playback using the connection instructions on page 10 of this manual.
- 2 Using an AUDIO/VIDEO cable, connect AUDIO and VIDEO IN on the VCR intended for recording to AUDIO and VIDEO OUT of SELECT OUT on the projection TV.

Notes:

- Do not change the input signal while editing through SELECT OUT.
- When connecting a single VCR to the projection TV: if VCR LINE OUT is connected to VIDEO IN on the projection TV, do not connect the SELECT OUT on the projection TV to the VCR LINE INPUT (see right). Doing so will cause program interference and other viewing problems.
- You can select the output signal from SELECT OUT of the SET UP menu. (see “SELECT OUT” on page 45)
- When the projection TV turns off, the signal is not output through SELECT OUT.

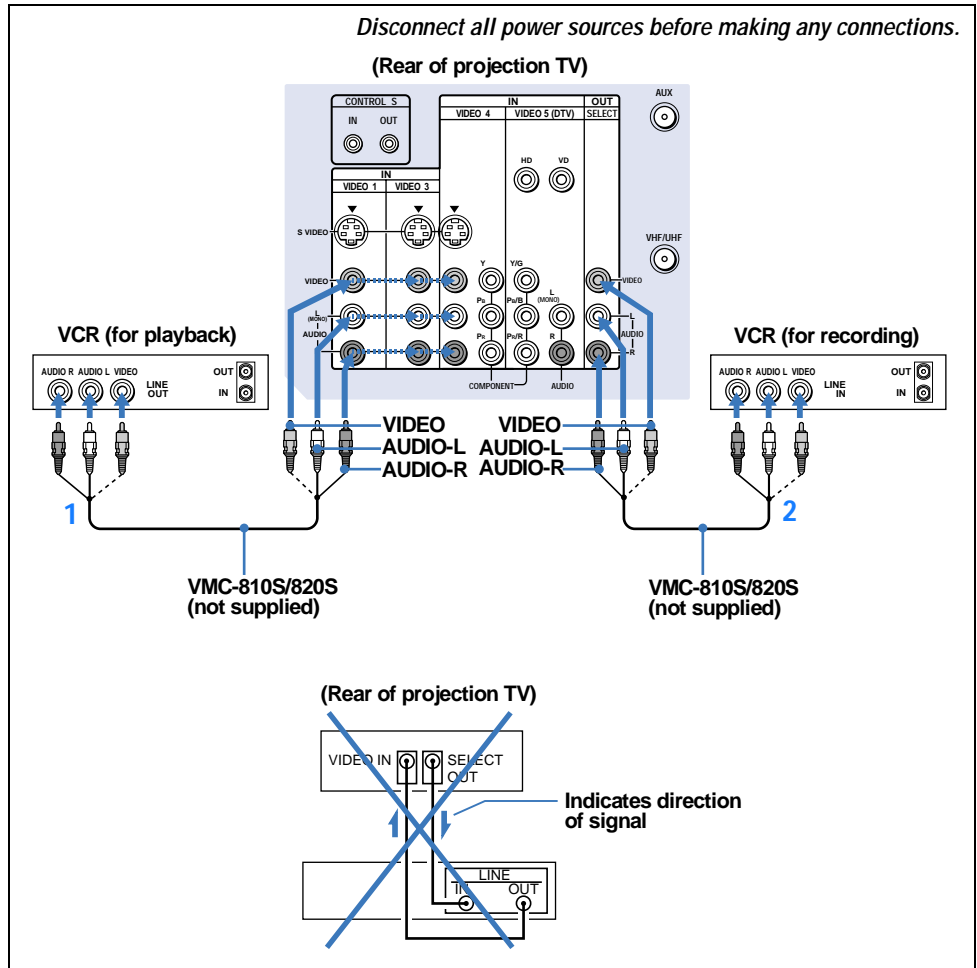

Connecting a DVD Player With S Video or Composite Video Output Connectors

Using an AUDIO and S VIDEO cables, connect AUDIO and S VIDEO IN on the projection TV to AUDIO and S VIDEO OUT on the DVD Player (White-AUDIO Left, Red-AUDIO Right).

Note:

- Since the high quality pictures on a DVD disc contain a lot of information, picture noise may appear. In this case, adjust NR in the VIDEO menu. (see “NR” on page 37)

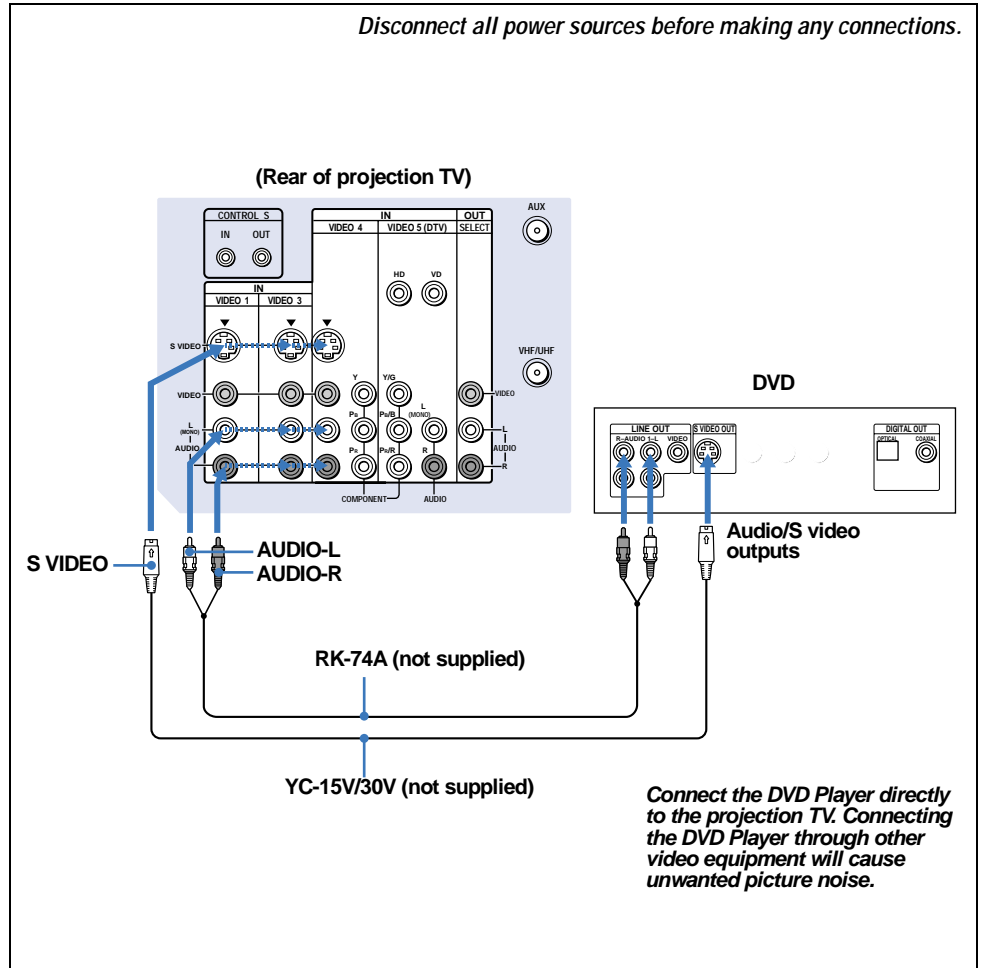

Connecting a DVD Player With Component Video Output Connectors

- Using an AUDIO cable, connect AUDIO R and L of LINE OUT on the DVD Player to AUDIO R and L of VIDEO 4 IN or VIDEO 5 (DTV) IN on the projection TV (White-AUDIO Left, Red-AUDIO Right).
- Using three VIDEO cables, connect Y, Pb and Pr of the COMPONENT VIDEO OUT on the DVD Player to Y, Pb and Pr of VIDEO 4 IN or VIDEO 5 (DTV) IN on the projection TV.

Notes:

- If your DVD Player has 480p format capability, connect it to the Y, Pb and Pr of VIDEO 5 (DTV) IN on the projection TV.
- Some DVD Player terminals may be labeled differently. If so, connect as follows:
Connect Y (green) to Y.
Connect Pb (blue) to CB, Cb or B-Y.
Connect Pr (red) to CR, Cr or R-Y.
- Since the high quality pictures on a DVD disc contain a lot of information, picture noise may appear. In this case, adjust NR in the VIDEO menu. (see "NR" on page 37)

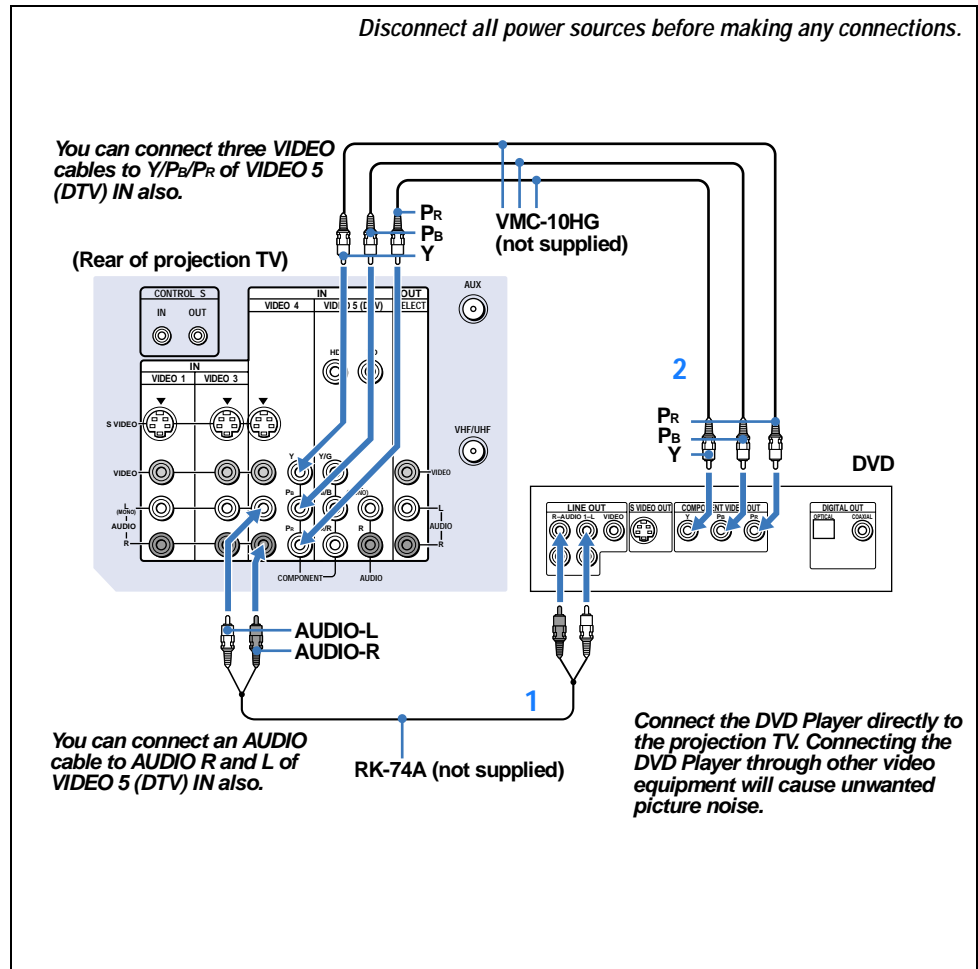

Connecting an AV Receiver

For greater control of all audio and video equipment, connect an AV receiver.

- 1-2 Perform as described on page 10.
- 3 Using a VIDEO cable, connect VIDEO of VIDEO 1 IN on the projection TV to MONITOR OUT on the AV receiver.
- 4 Using an AUDIO/VIDEO cable, connect SELECT OUT on the projection TV to VIDEO 2 IN on the AV receiver.
- 5 Using an AUDIO/VIDEO cable, connect the video equipment to the AV receiver.
- 6 Select the SET UP menu and set SELECT OUT to TV OUT. (see "SELECT OUT" on page 45)

Note:

- You may want to use CHANNEL FIX to fix your TV's input to the AV receiver (VIDEO 1). (see "CHANNEL FIX" on page 42)

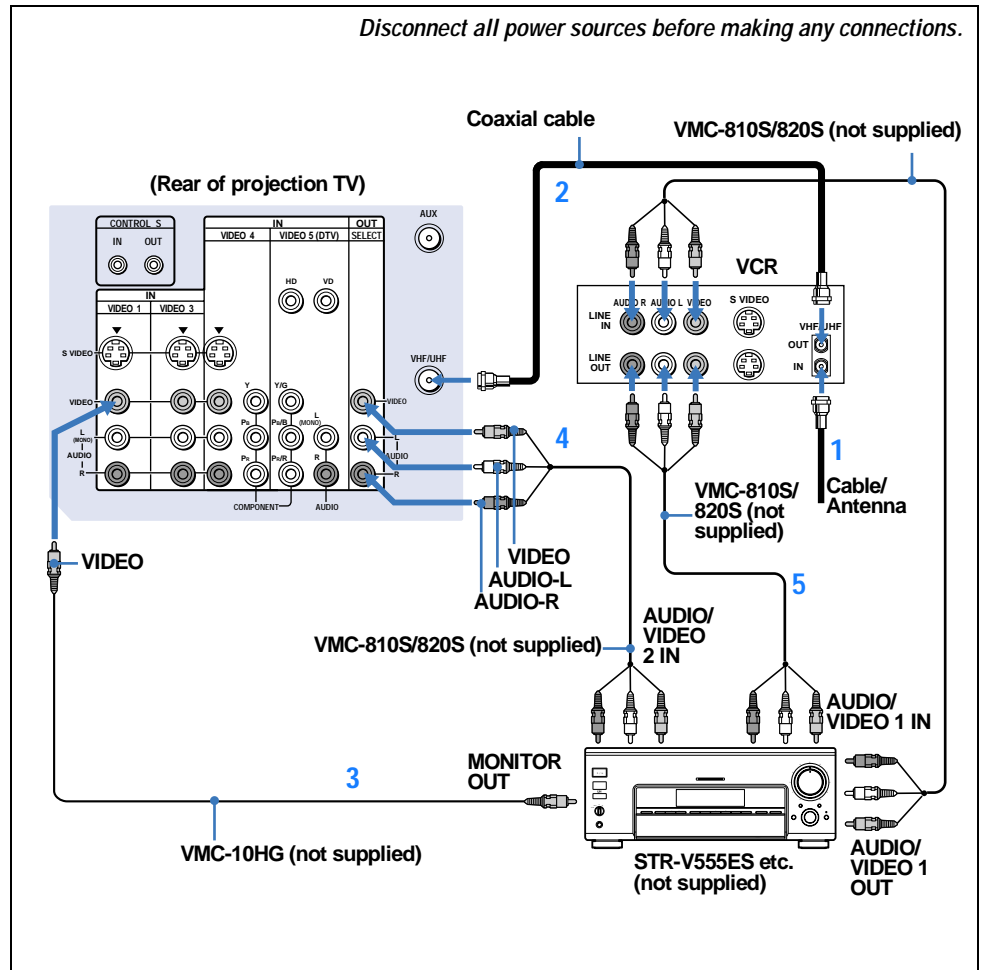

Connecting an Audio System

For more dynamic sound, connect an audio system to the projection TV.

- 1 Using an AUDIO cable, connect AUDIO (VAR) OUT on the projection TV to one of the unused Line inputs (e.g. Tape-2, AUX1, etc.) on the stereo (White-AUDIO Left, Red-AUDIO Right).
- 2 Set the stereo to the chosen Line input and use the AUDIO menu to switch the TV's speakers off. (see "SPEAKER" on page 38)

Note:

- You can adjust VOLUME, BASS, TREBLE and BALANCE through the projection TV on AUDIO (VAR) OUT only.

Disconnect all power sources before making any connections.

(Rear of projection TV)

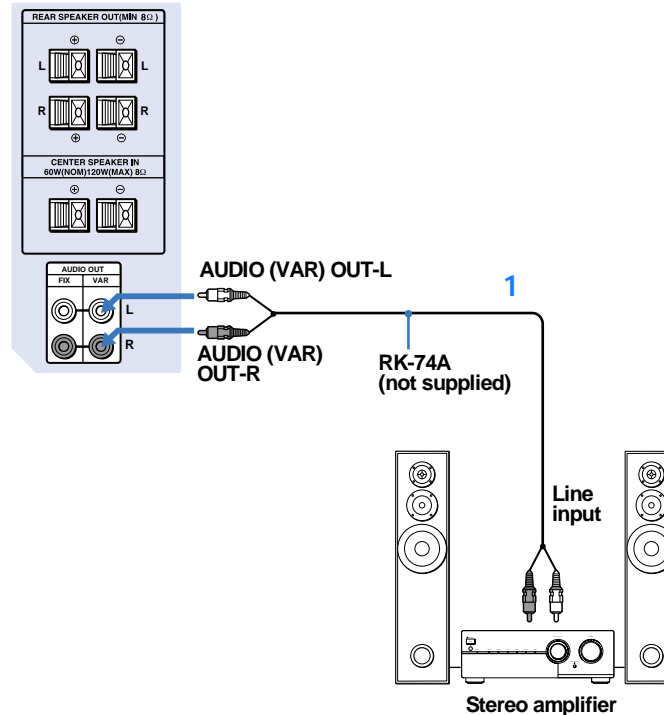

Connecting an Amplifier That Supports Dolby Pro Logic Decoder

If you use an amplifier with a Dolby Pro Logic decoder instead of the projection TV's audio system, you can still use the projection TV's speaker as a center speaker.

- 1 Using the speaker cords (supplied with the amplifier), connect the speaker terminals on the amplifier to CENTER SPEAKER IN +/- on the projection TV.
- 2 Using an AUDIO cable, connect AUDIO (FIX) OUT on the projection TV to one of the unused Line inputs (e.g. Tape-2, AUX1, etc.) on the amplifier (White-AUDIO Left, red-AUDIO Right).
- 3 Set the amplifier to the chosen Line input and use the AUDIO menu to set "SPEAKER" to "CENTER IN" on the projection TV. (see "SPEAKER" on page 38)

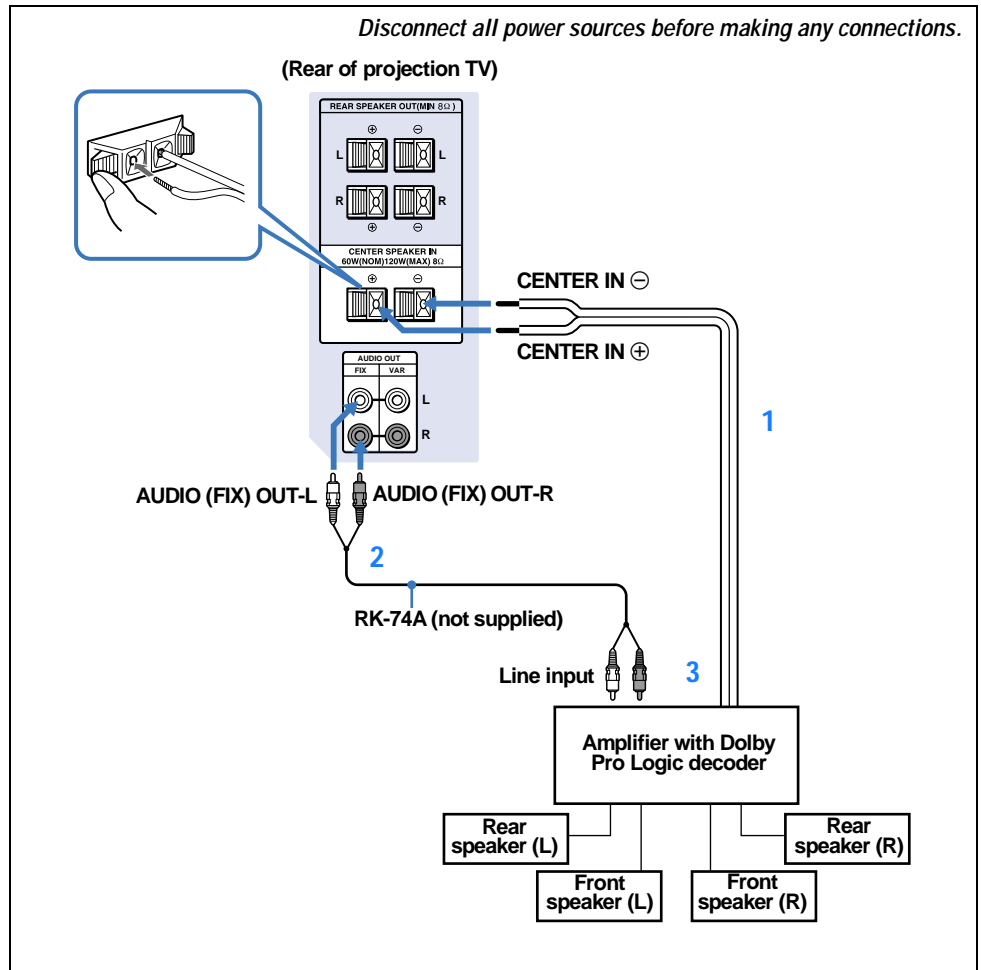

Using the Remote Control

Inserting the batteries

Insert two size AA (R6) batteries (supplied) by matching the + and – on the batteries to the diagram inside the remote control's battery compartment.

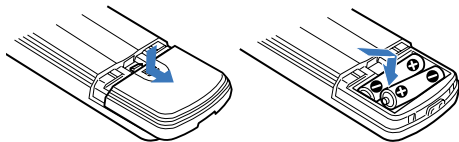

Notes:

- Remove the batteries to avoid damage from possible battery leakage whenever you anticipate that the remote control will not be used for an extended period.
- Handle the remote control with care. Avoid dropping it, getting it wet, or placing it in direct sunlight, near a heater or where the humidity is high.
- Your remote control can be programmed to operate most video equipment. (see "Operating Video Equipment" on page 54)

Using the remote control joystick

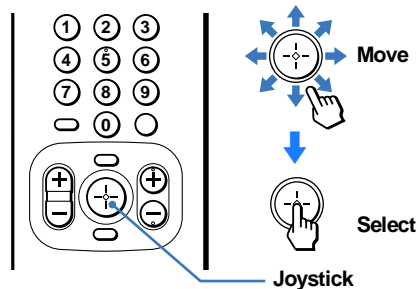

The supplied remote control has a joystick which moves the on-screen selector in eight directions. In most cases, moving the joystick up, down, left or right will cause the selector to move in the selected direction.

In some cases, the selector may move in eight directions according to the function. Pressing down on the center of the joystick (+) will activate the selected item.

You may also move the joystick right to activate a selected item. (There are some exceptions to this option.)

Adjusting sliders

When menu items present a slider (■ or ⇄), move the joystick up, down, left or right to adjust the setting.

On-line help/Instructions

Several menu windows will provide prompts and instructions to assist you in navigating through the different functions.

Setting Up the Projection TV Automatically

The AUTO SET UP feature will allow you to set the on-screen language and set all receivable channels.

The AUTO SET UP feature does not apply for installations that use a cable box for all channel selection.

You can also set up the projection TV manually. (see "Using the CHANNEL SET UP Menu" on page 41)

Notes:

- Perform this function during the day, with the antenna and/or cable properly connected, to ensure that all available channels will be broadcasting and receivable.
- Before you perform AUTO SET UP again, make sure that the input from ANT (not AUX) is selected by pressing ANT until "AUX" does not appear next to the channel number.
- When you perform AUTO PROGRAM, your CHANNEL FIX and ON/OFF TIMER settings will be erased.
- When you perform AUTO SET UP, all the settings in the VIDEO and AUDIO menus are reset to the factory settings.

Using the buttons on the front panel and inside the drop-down panel on the projection TV:

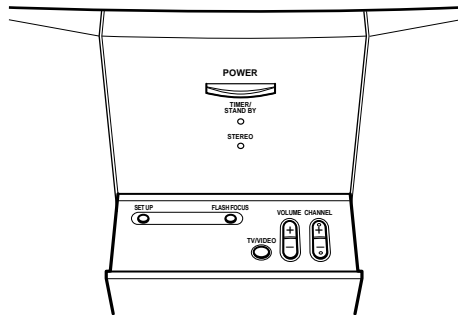

- 1 Press POWER to turn on the projection TV.

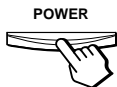

- 2 Press SET UP inside the drop-down panel. The AUTO SET UP screen appears.

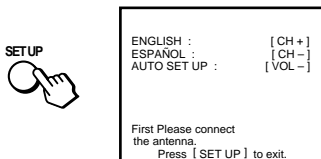

- 3 Press CHANNEL + to select English, CHANNEL - to select Spanish.

The screen will change to reflect your choice.

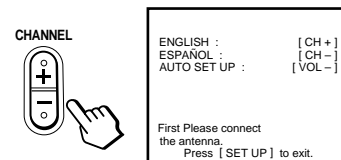

- 4 Press VOLUME - to continue.

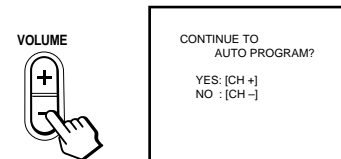

- 5 Press CHANNEL + to preset channels automatically.

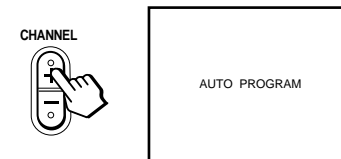

"AUTO PROGRAM" appears and the projection TV starts scanning and presetting channels automatically. While scanning, the received channel will be displayed on the sub screen. When all the receivable channels are stored, the lowest numbered channel will be displayed.

If your projection TV is not connected to a cable system

If you perform AUTO SET UP, CABLE is set to ON automatically. After finishing AUTO SET UP, set CABLE to OFF in the CHANNEL SET UP menu, then set AUTO PROGRAM to YES to perform automatic channel presetting. (see “CABLE” and “AUTO PROGRAM” on page 42)

To perform AUTO SET UP again

- Press SET UP inside the drop-down panel of the projection TV, and perform steps 3-5 on page 24.
- Press CHANNEL + or CHANNEL – to select a language.
- Press VOLUME – to restore factory settings (“CONTINUE TO AUTO PROGRAM?” will appear on the screen. Press CHANNEL + to execute or CHANNEL – to exit).
- Press SET UP to exit.

Adjusting the Convergence Automatically (FLASH FOCUS)

The projection tube image appears on the screen in three layers (red, green and blue). If they do not converge, the color is poor and the picture blurs.

Before you use your projection TV, be sure to adjust the convergence.

The FLASH FOCUS feature allows you to adjust the convergence automatically.



It is recommended to perform FLASH FOCUS about 30 minutes after the projection TV is first turned on.

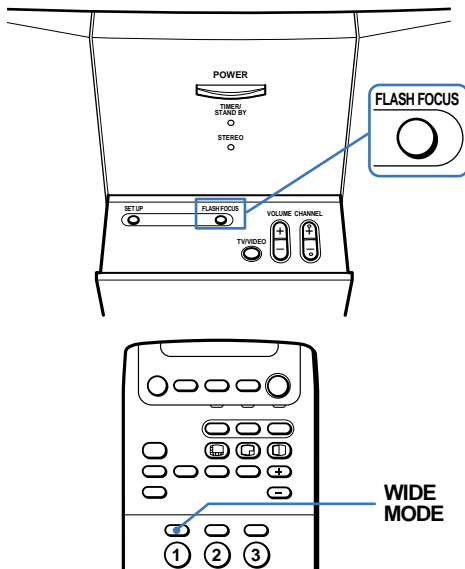

- 1 Receive a TV or cable TV program.
- 2 Press FLASH FOCUS for every wide screen mode; NORMAL, WIDE ZOOM, ZOOM and FULL.



To select the wide screen mode, press WIDE MODE on the remote control.

The cross pattern appears and FLASH FOCUS begins to work. The adjustment is completed when the cross pattern becomes white.

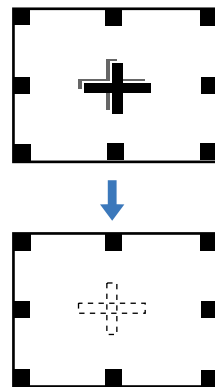

To obtain an optimum convergence for Digital TV programs

The optimum convergence alignment varies with digital TV formats. Whenever you find that the picture blurs, press FLASH FOCUS.

Notes:

- You cannot perform any other functions until FLASH FOCUS has completed its cycle.
- If you perform any other operation while FLASH FOCUS is in progress, FLASH FOCUS operation is canceled.

Watching the TV

Many TV features can be accessed directly through the remote control. The following will explain the function of some buttons found on your remote control.

Using the white labeled buttons for projection TV operations



REFER TO THE ILLUSTRATION OF THE REMOTE CONTROL ON THE INSIDE FRONT COVER OF THIS MANUAL AS YOU REVIEW THE FOLLOWING DESCRIPTIONS

TV (FUNCTION)

Activates the remote control for use with the projection TV.

ANT — (AUX input)

Press to change between the VHF/UHF input and the AUX input. (for detailed connection information, see “Cable and antenna” on page 8 or “Cable box and cable” on page 9).

TV POWER

Turns the projection TV on and off. If a video input indication (e.g., VIDEO 1, VIDEO 2) appears on the screen, press TV/VIDEO until a channel number appears.

0 - 9 and ENTER

Use for direct channel selection. Press 0-9 to select a channel (for example, to select channel 10, press 1 and 0). The channel will change after 2 seconds, or you can press ENTER for immediate selection.

CH +/-

Press to scan through the channels (+ up or – down).

VOL +/-

Press to adjust the volume (+ up or – down).

JUMP

Press to alternate or jump back and forth between two channels. The projection TV will jump between the current channel and the last channel selected using the 0-9 buttons.

MUTING

Press to mute the sound. “MUTING” will appear on the screen and will dim three seconds later. To restore sound, press again or press VOL +.

FREEZE

— (yellow labeled button)

This is useful when you need to copy down information that appears on the TV’s screen.

Press to freeze the picture.

Press again or press **OFF** to cancel.

If you select TWIN as a FREEZE MODE in the SET UP menu, you can freeze the desired scene and display it on the left while viewing the normal picture on the right. (see “FREEZE MODE” on page 46)

Notes:

- The FREEZE button does not function with the picture from VIDEO 5 (DTV) IN.
- If the frozen picture mode is not canceled for more than an hour, the normal picture is resumed automatically.

SLEEP

Press repeatedly until the projection TV displays the approximate time in minutes (30, 60, or 90) that you want the projection TV to remain on before shutting off automatically.

Cancel by pressing until “SLEEP OFF” appears.

DISPLAY

Press to display the channel number, current time, channel caption (if set), and MTS mode (if SAP is selected). The SAP indication disappears and the other indications dim three seconds later.

To turn the display off, press DISPLAY again.



Press repeatedly to scroll through available displays:

Caption Vision

Displayed on the screen if the broadcaster offers this service. (see “CAPTION VISION” on page 45)

XDS (Extended Data Service)

Displays a network name, program name, program type, program length, program description, call letters and time of the show if the broadcaster offers this service.

No display

“OFF” appears and the display is canceled.

TV/VIDEO

Press repeatedly to scroll through available video inputs:

TV, VIDEO 1, VIDEO 2, VIDEO 3, VIDEO 4 and VIDEO 5

If you select SKIP as a VIDEO LABEL in the SET UP menu, your projection TV will skip the video input you selected. (see “VIDEO LABEL” on page 46)

MTS

Press to scroll through the Multi-channel TV Sound (MTS) options. (see “MTS” on page 37)

PICTURE MODE

Press PICTURE MODE repeatedly to directly choose one of five different video modes that best suits the program you are watching.

VIVID:

Select for enhanced picture contrast and sharpness.

STANDARD:

Select to display a standard picture for normal viewing environments.

MOVIE:

Select to display a finely detailed picture for low light environments.

GAME:

Select to display graphics such as a video game.

PRO (Professional):

Select to display a picture with minimum enhancements.

When you select each mode, you can also adjust the picture quality (such as BRIGHTNESS, COLOR, etc.) to suit your taste.

For details, see “MODE” on page 36.

Watching Digital TV

When you have connected the DTV receiver, you can enjoy digital TV programs. This projection TV is capable of receiving the 1080i, 720p, 480p and 480i digital TV formats.

Note:

This projection TV is not capable of displaying a 720p format signal as it is. When the 720p format signal is received, it is converted into a 480p format signal.

To view a digital TV program

- 1 Connect the DTV receiver to VIDEO 5 (DTV) IN on the projection TV. (for details, see pages 13 and 12)
- 2 Press TV/VIDEO to select VIDEO 5. The digital TV format being received is displayed on the screen for three seconds.

Note:

- You cannot select VIDEO 5 unless a DTV receiver is connected.

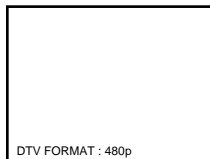

- 3 Select a digital channel on the DTV receiver. For details, see the Operating Instructions of the DTV receiver.
- 4 Adjust the volume on this projection TV.



The optimum convergence alignment varies with digital TV formats. Whenever you find that the picture blurs, press FLASH FOCUS. (for details, see page 25)

Watching the Picture in Wide Screen Mode Automatically - AUTO WIDE

When a 480i format signal with an ID-1 (16:9 aspect ratio recorded) signal is received, the projection TV automatically selects wide screen mode.

Notes:

- When the AUTO WIDE function does not work correctly due to the quality of signal, select wide screen mode manually. (see page 29)
- The AUTO WIDE function does not work when the following signals are received:
 - 480i format signal without an ID-1 (aspect ratio recorded) signal
 - 480p format signal
 - 720p/1080i format signals (The picture is always displayed in FULL mode)

Activating the AUTO WIDE function

Set AUTO WIDE in the WIDE SCREEN MODE menu to ON. (see page 40)

To deactivate the AUTO WIDE function

Set AUTO WIDE in the WIDE SCREEN MODE menu to OFF. (see page 40)

When receiving a normal 4:3 broadcast – NORMAL

When a normal 4:3 aspect ratio picture with an ID-1 signal is received, NORMAL mode is automatically selected. The picture is not enlarged and is displayed as it is.

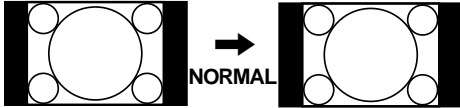

When enlarging the picture to fill the 16:9 screen, select WIDE ZOOM in WIDE SCREEN MODE menu manually. (see “Using WIDE ZOOM mode” on this page)

When receiving a 4:3 squeezed picture – FULL

When a squeezed video camera or DVD picture with an ID-1 signal is received, FULL mode is automatically selected. The picture is enlarged horizontally only, to fill the 16:9 screen.

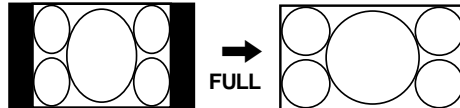

Note:

- The 720p/1080i format signal is displayed in FULL mode always.

Watching the Picture in Wide Screen Mode Manually - WIDE MODE

You can select the wide screen mode manually.

Note:

The 720p/1080i format signal is displayed in FULL mode always.

Press WIDE MODE repeatedly on the remote control.

WIDE MODE



Each press scrolls through the following modes:

NORMAL → WIDE ZOOM → ZOOM → FULL

For details on each mode, see “To select the wide screen mode automatically – WIDE MODE.”

When selecting the wide screen mode manually – Temporarily Auto Wide Off

When the wide screen mode is selected by pressing the WIDE MODE button on the remote control, the AUTO WIDE function does not work temporarily. However, the settings of AUTO WIDE in WIDE SCREEN MODE menu remains.

AUTO WIDE function works again when:

- video input signals are changed (see “TV/VIDEO” on page 27)
- the projection TV is turned off
- DIRECT PLAY is selected (see page 46)
- ON/OFF TIMER works (see page 40)
- AUTO WIDE in WIDE SCREEN MODE menu is set to ON again (see page 40).

Using WIDE ZOOM mode

You can enlarge a normal 4:3 picture of 480i format signal by selecting WIDE ZOOM. The picture is enlarged, while the upper and lower parts of the picture are condensed to fit the 16:9 screen.

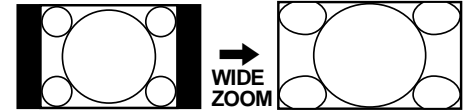

Using ZOOM mode

You can enlarge a letter box movie (16:9 aspect ratio) of a video tape or a DVD disc by selecting ZOOM.

The picture is enlarged horizontally and vertically to an equal aspect ratio that fills the 16:9 screen.

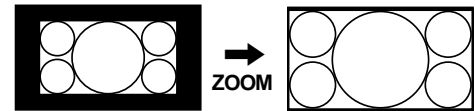

Caution about continued wide screen mode usage for 4:3 aspect ratio pictures

This projection TV was designed primarily for viewing TV broadcasts in wide screen mode (16:9 aspect ratio pictures). Consistent and exclusive viewing of 4:3 aspect ratio programs in NORMAL mode will lead to permanent imprinting of the gray band on both sides of the picture.

Therefore, when you watch conventional 4:3 ratio TV programs, we recommend you select WIDE ZOOM mode by using WIDE MODE button.

Notes:

- Depending on the picture format, black bands may be present on the top and bottom of the screen.
- For ZOOM and WIDE ZOOM modes you can adjust the vertical position of the picture. (see “V CENTER” on page 41)

Watching Two Programs at One Time — PIP

The Picture-in-Picture (PIP) feature allows you to view two channels simultaneously, one in the full size “main” picture and one in a smaller “window” picture.

You can move the window picture to any location on the screen.

Note:

- The PIP feature is not available for the inputs from VIDEO 5 (DTV) IN.

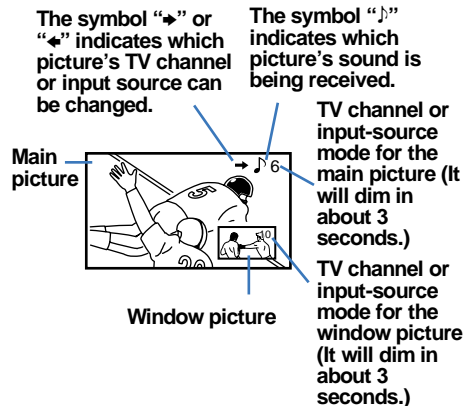

Using the yellow labeled buttons for PIP operations



REFER TO THE ILLUSTRATION OF THE REMOTE CONTROL ON THE INSIDE FRONT COVER OF THIS MANUAL AS YOU REVIEW THE FOLLOWING DESCRIPTION

Tip

If you press RESET in PIP mode, the window picture will move to the bottom right (factory-preset location).



Press to display a window picture.

Each time you press this button, the picture size will change (1/4 → 1/9 → 1/16).



Press **OFF** to close the window picture.

POSITION



Press to change the location of the window picture (counterclockwise) around the main picture.

ACTIVE



Press to select either the main or window picture in order to change the TV channel or video source using the white labeled buttons below. The symbol “→” (or “←”) will appear to indicate which picture’s channel or input mode can be changed.



To change the location of the window picture, move the joystick in any direction and release it when the picture is in the desired location.



Press repeatedly to scroll through the available video inputs for the picture on which the symbol “▶” (or “◀”) is displayed. (see “TV/VIDEO” on page 27)



— (white labeled button)

Press to select the TV channel on which the symbol “▶” (or “◀”) is displayed. (for details, see “Watching the TV” on page 26)



Press to change between the VHF/UHF input and the AUX input for the picture on which the symbol “▶” (or “◀”) is displayed.



Press to alternate sound between the main picture and the window picture. The symbol “♪” will appear for a few seconds to indicate which picture’s sound is being received.



This is useful when you need to copy down information that appears on the TV’s screen.

Press to freeze the main and window pictures.

Press again to resume PIP viewing. Press  to cancel and resume normal TV viewing.



Press to switch the audio and video of the main picture and the window picture.

Each time you press SWAP, the picture and sound of the two will be exchanged.



Press to access CHANNEL INDEX for direct channel selection. (see “Using CHANNEL INDEX” on page 33)



Press to cancel the PIP function and return to normal viewing.

Notes:

- If one of the pictures received through PIP is snowy, the entire screen may become unstable. In this case, erase the snowy channel. (see “CHANNEL SKIP” on page 41)
- If you select VIDEO 5 when the main picture is active, the window picture disappears and you can view the picture from VIDEO 5 (DTV) IN. When the window picture is active, you cannot view the picture from VIDEO 5 (DTV) IN.

Watching Two Programs at One Time — P&P (Twin View™)

The Picture-and-Picture (P&P) feature allows you to view two channels simultaneously, both in a reduced size screen. The main picture will appear on the right.

You can change the size of both pictures to suit your personal preference.

Note:

- The P&P feature is not available for the inputs from VIDEO 5 (DTV) IN.

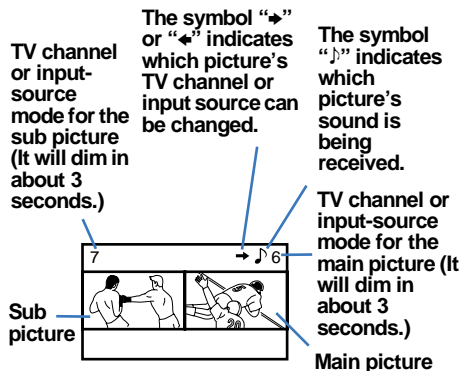

Using the yellow labeled buttons for P&P operations

REFER TO THE ILLUSTRATION OF THE REMOTE CONTROL ON THE INSIDE FRONT COVER OF THIS MANUAL AS YOU REVIEW THE FOLLOWING DESCRIPTIONS

Tip

If you press RESET in P&P mode, the right and left pictures will be reset to the same size (factory-preset size.)



Press to display right (main) and left pictures.

Press **OFF** to close the sub picture.



— (white labeled button)

Press and hold either RIGHT or LEFT to zoom in on the selected picture.

Release at the desired size. The other picture will be zoomed out simultaneously.

Moving the joystick right or left will activate the same function.

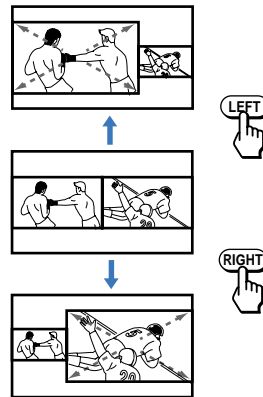

ACTIVE



Press to select either the right or left picture in order to change the TV channel or video source using the white labeled buttons below. The symbol “↗” (or “↖”) will appear to indicate which picture’s channel or input mode can be changed.

TV/VIDEO — (white labeled button)



Press repeatedly to scroll through the available video inputs for the picture on which the symbol “↗” (or “↖”) is displayed. (see “TV/VIDEO” on page 27)

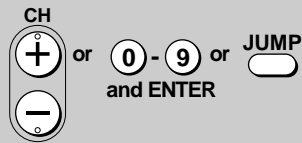

— (white labeled button)

Press to select the TV channel on which the symbol “➔” (or “➜”) is displayed. (for details, see “Watching the TV” on page 26)



Press to change between the VHF/UHF input and the AUX input for the picture on which the symbol “➔” (or “➜”) is displayed.



Press to alternate sound between the right and left pictures. The symbol “J” will appear for a few seconds to indicate which picture’s sound is being received.



This is useful when you need to copy down information that appears on the TV’s screen.
Press to freeze both the right and left pictures.
Press again to resume P&P viewing or press (OFF) to cancel and resume normal TV viewing.



Press to switch the audio and video of the right and left pictures.

Each time you press SWAP, the picture and sound of the two will be exchanged.



Press to cancel the P&P function and return to normal viewing.

Notes:

- If one of the pictures received through P&P is snowy, the entire screen may become unstable. In this case, erase the snowy channel. (see “CHANNEL SKIP” on page 41)
- If you select VIDEO 5 when the right picture is active, the left picture disappears and you can view the picture from VIDEO 5 (DTV) IN. When the left picture is active, you cannot view the picture from VIDEO 5 (DTV) IN.

Using CHANNEL INDEX

You can use the CHANNEL INDEX feature to display multiple channels and select one directly. Channels used for CHANNEL INDEX will come directly from the TV’s list of receivable channels (those set during AUTO PROGRAM or through the CHANNEL SET UP menu).

Note:

- The CHANNEL INDEX feature is not available for the inputs from VIDEO 5 (DTV) IN.

1 Press .

The current channel will be reduced in size and displayed in the center of the screen in normal motion picture format. The first twelve receivable channels will appear one after another, clockwise, around the center picture. These small pictures are updated in intervals of one second. The channel number and channel caption (if set) on the second and later appearances will dim.

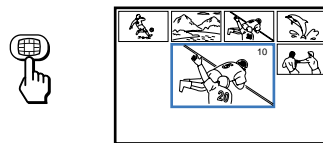

A cyan-colored frame will appear to indicate current channel selection.

2 Move the joystick in any direction to move the cyan frame to the picture that you wish to view, and press .



(continued)

The selected channel will zoom in and move to the center, and the sound of that channel will be heard.



- 3 If you wish to view another channel, repeat step 2.

To view the normal picture of the selected channel, proceed to step 4.

- 4 Press .

The center picture will be enlarged for normal viewing.



Notes:

- You cannot move the cyan frame until all of the surrounding pictures appear.
- The projection TV will continually update each of the surrounding pictures while the CHANNEL INDEX screen is displayed.
- Sound will only be heard from the center picture.
- If one of the pictures received through CHANNEL INDEX is snowy, the entire screen may become unstable. In this case, erase the snowy channel. (see "CHANNEL SKIP" on page 41)

- If you leave the CHANNEL INDEX screen displayed for an hour without any additional operation, CHANNEL INDEX is canceled and the normal picture reappears.

Using the yellow labeled buttons for CHANNEL INDEX operations



REFER TO THE ILLUSTRATION OF THE REMOTE CONTROL ON THE INSIDE FRONT COVER OF THIS MANUAL AS YOU REVIEW THE FOLLOWING DESCRIPTIONS



Press to display the next twelve receivable channels.



Press to cancel the current operation and return to normal TV viewing.



Press to freeze the center picture.

Press again to cancel the frozen picture and resume normal center picture viewing.

Using the white labeled buttons for center picture operations



REFER TO THE ILLUSTRATION OF THE REMOTE CONTROL ON THE INSIDE FRONT COVER OF THIS MANUAL AS YOU REVIEW THE FOLLOWING DESCRIPTIONS



Press to scroll the center picture through the video inputs.

The surrounding channels will not change.



Press to switch the center picture between the VHF/UHF input and the AUX input.



Press to select a channel for the center picture. (for details, see "Watching the TV" on page 26)

Adjusting Your SET UP (menus)

Learning Menu Selection

Use the MENU button to access a menu and use the joystick to alter the settings. Use the following example to learn how to modify settings.

- 1 Press the MENU button.

The main menu appears.

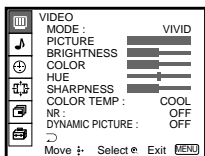

- 2 Move the joystick up or down to highlight the desired menu and press \oplus (press down on the center of the joystick) to activate it.

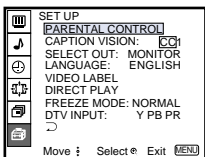
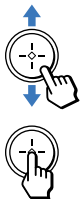

You may also move the joystick right to activate your selection.

- 3 Move the joystick up or down to highlight the desired option.

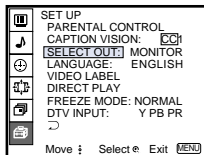

- 4 Press \oplus (press down on the center of the joystick).

Options for your selection (Pop-up menu or Adjusting menu) will be displayed.

Pop-up menu

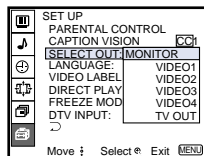

Adjusting menu

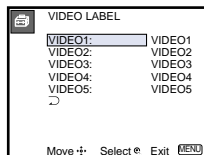

- 5 Move the joystick up or down to make your selection and press \oplus to activate it.

The previous screen will reappear.

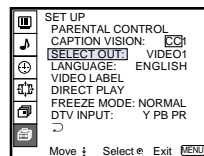

Some adjustment menus may require further operations. For details, see each menu option.

To return to the previous screen (except for the slider adjustment menus), choose \leftarrow at the bottom of the menu and press \oplus or move the joystick left.

- 6 Once you have completed all menu corrections, press MENU to exit the menu screens.



To exit from the menus at any time

Press MENU.

Using the VIDEO Menu

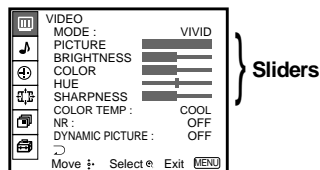

For detailed information on using the remote control to modify menu settings, refer to “Learning Menu Selection” on page 35.

To select the VIDEO menu:

Display → Highlight → Select

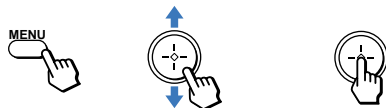

MODE

— [Customized picture viewing](#)

You can choose one of five different video modes that best suits the program you are watching. You can also adjust the picture quality (such as BRIGHTNESS, COLOR, etc.) for each MODE to suit your taste.

First select each MODE individually before adjusting the picture quality.

VIVID:

Select for enhanced picture contrast and sharpness.

STANDARD:

Select to display a standard picture for normal viewing environments.

MOVIE:

Select to display a finely detailed picture for low light environments.

GAME:

Select to display graphics such as a video game.

PRO (Professional):

Select to display a picture with minimum enhancements.

Press PICTURE MODE on the remote control for direct selection of a MODE setting.

PICTURE

— [Picture Adjustment](#)

Adjust slider right (up) to increase picture contrast.

Adjust slider left (down) to decrease picture contrast.

BRIGHTNESS

— [Picture Adjustment](#)

Adjust slider right (up) to brighten the picture.

Adjust slider left (down) to darken the picture.

COLOR

— [Picture Adjustment](#)

Adjust slider right (up) to increase color intensity.

Adjust slider left (down) to decrease color intensity.

HUE

— [Picture Adjustment](#)

Adjust slider right (up) to increase the green tones.

Adjust slider left (down) to increase the red tones.

SHARPNESS

— [Picture Adjustment](#)

Adjust slider right (up) to sharpen the picture.

Adjust slider left (down) to soften the picture.

COLOR TEMP

— [White Intensity \(Color Temperature\) Adjustment](#)

COOL:

Select to give the white colors a blueish tint.

NEUTRAL:

Select to give the white colors a neutral tint.

WARM:

Select to give the white colors a reddish tint.

NR

— Picture Noise Reduction

Select **ON** to reduce picture noise.

Select **OFF** to cancel the feature.

NR can be set separately from the MODE settings of the VIDEO menu.

DYNAMIC PICTURE

— Black Intensity Adjustment

Select **ON** to emphasize the black level and to produce a bolder dynamic picture.

Select **OFF** to cancel the feature.

To restore the factory settings

Press RESET on the remote control while the VIDEO menu is selected. To restore each MODE to the factory setting, press RESET after selecting the mode to be reset.

Using the AUDIO Menu

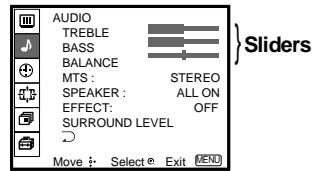

For detailed information on using the remote control to modify menu settings, refer to “Learning Menu Selection” on page 35.

To select the AUDIO menu:

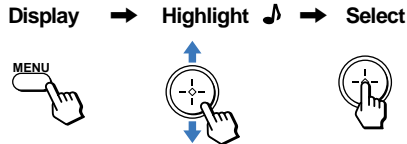

TREBLE

— Sound Adjustment

Adjust slider right (up) to increase high pitched sounds.

Adjust slider left (down) to decrease high pitched sounds.

BASS

— Sound Adjustment

Adjust slider right (up) to increase low pitched sounds.

Adjust slider left (down) to decrease low pitched sounds.

BALANCE

— Sound Adjustment

Adjust slider right (up) to emphasize right speaker volume.

Adjust slider left (down) to emphasize left speaker volume.

MTS

— Enjoy stereo, bilingual and mono programs

STEREO:

Select for stereo reception when viewing a program broadcast in stereo.

SAP:

Select to listen to a bilingual broadcast. (non-SAP programs will be muted when this feature is selected)

MONO:

Select for mono reception. (use to reduce noise during stereo broadcasts)

Quick MTS access:

Press MTS on your remote control to cycle through the MTS options as follows: (STEREO → SAP → MONO → STEREO).

Note:

- The MTS function is not available for input from an external equipment connected VIDEO 1, VIDEO 2, VIDEO 3, VIDEO 4 or VIDEO 5 (DTV) IN.

SPEAKER

— *Custom selection of audio output source*

ALL ON:

Select to listen to the sound from the projection TV speakers alone.

L/R OFF:

Select to turn off the projection TV left and right speakers and listen to the left and right channel sounds through a separate audio system's speakers.

ALL OFF:

Select to turn off the projection TV speakers and listen to the projection TV's sound only through an external audio system's speakers.

CENTER IN:

Select to use the projection TV center speaker as center speaker when you connect an amplifier with a Dolby Pro Logic decoder. (see "Connecting an Amplifier That Supports Dolby Pro Logic Decoder" on page 22)

EFFECT

— *Customizes surround sound effects based on the program's audio type*

EFFECT can only be set when SPEAKER is set to ALL ON or L/R OFF.

PRO LOGIC:

Produces superb theater-like surround effects. Most effective for programs encoded in Dolby surround.

3 STEREO:

Produces a dynamic three dimensional sound without using the rear speakers. The sound of the rear channel is output from the front speakers.

SRS 3D MONO:

Adds a surround-like effect to mono programs.

LIVE:

Produces surround effects with the atmosphere of a concert hall.

GAME:

Produces maximum audio impact. Most effective for video games.

OFF:

Normal stereo or mono reception.

SURROUND LEVEL

— *Speaker volume adjustment for surround modes*

After selecting one of the surround modes, adjust the volume of each speaker so that the sound will be even and natural. (see "Adjusting the Speaker Volume for Customized Surround Mode" on the right column)

To restore the factory settings

Press RESET on the remote control while the AUDIO menu is selected.

However, EFFECT is not reset to the factory setting even if you press RESET.

Adjusting the Speaker Volume for Customized Surround Mode

After you set EFFECT to one of the modes, adjust the volume of the front, center and rear speakers to the same level so that the projection TV's sound will be even and natural. For PRO LOGIC and 3 STEREO, adjust the speaker volume using the test tone feature.

Adjusting the speaker volume

- 1 Connect the rear speakers (not supplied). For details, see "Mounting the Rear Speakers (not supplied)" on pages 6 and 7.
- 2 Select SURROUND LEVEL from the AUDIO menu. (see "SURROUND LEVEL" on the left column)

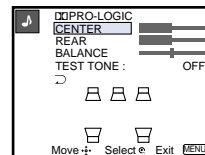

- 3 Move the joystick up or down to select the speaker for volume adjustment and press (+).

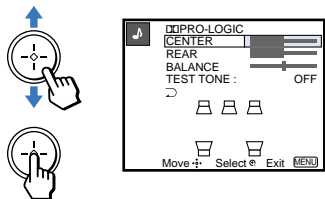

CENTER: Select to adjust the level of the center speaker. (not available for SRS 3D MONO)

REAR: Select to adjust the level of the rear speakers. (not available for D3 STEREO)

BALANCE: Select to adjust the balance between the right and left speakers.

- 4 Move the joystick up, down, left or right to adjust the volume level and press (+).
- 5 Use the joystick to select other speakers and to adjust the volume levels.

Adjusting the speaker volume using the test tone

The TEST TONE feature makes it easier to adjust the volume level. You can use this feature for DPRO LOGIC and D3 STEREO modes only.

- 1 With the SURROUND LEVEL window open, move the joystick up or down to select TEST TONE and press (+).

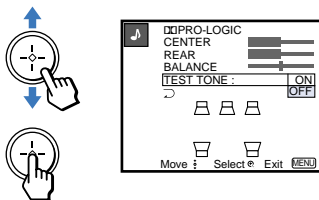

- 2 Move the joystick up or down to select ON.

A test tone will be output from each speaker in sequence:

Front left → Center → Front right → Rear

To turn off the test tone, select OFF.

- 3 Follow steps 2 through 4 in “Adjusting the speaker volume.”

Note:

You can adjust the volume using the test tone independent of the projection TV’s operation.

Using the TIMER Menu

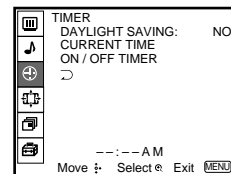

After setting the clock you can use the timer to turn the projection TV on and off.

For detailed information on using the remote control to modify menu settings, refer to “Learning Menu Selection” on page 35.

To select the TIMER (+) menu:

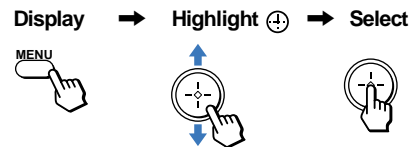

Tip

Set daylight saving time before setting the clock. Any loss of power will cause these settings to be erased.

(continued)

DAYLIGHT SAVING

— Automatically adjusts the time.

Select **YES** to compensate for Daylight Saving Time in spring. The current time automatically moves ahead one hour.

Select **NO** at the end of Daylight Saving Time in fall. The current time moves back one hour.

CURRENT TIME

— Necessary for the **TIMER**.

1 Press \oplus , then move the joystick up or down until the current day (MON-SUN) is displayed, and press \oplus .

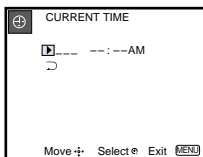

2 Move the joystick up or down until the current hour (1-12) and AM/PM is displayed, and press \oplus .

3 Move the joystick up or down until the current minute (00-59) is displayed, and press \oplus .

The Clock has now started. Press MENU to exit.

ON/OFF TIMER

— Wake up or scheduled viewing.

1 Select the desired timer (1 or 2).

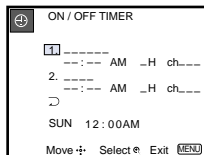

2 Move the joystick up or down until the desired day (MON-SUN) or range of days (EVERY SUN-SAT or EVERY MON-FRI) is displayed, and press \oplus .

3 Move the joystick up or down until the time (hours and minutes) that you want the projection TV to remain on is displayed, and then press \oplus .

4 Move the joystick up or down to set the time duration (maximum of 6 hours) and press \oplus .

5 Move the joystick up or down to select the desired channel and press \oplus .

The timer is now set. The **TIMER/STAND BY** indicator on your projection TV will be lit.

Press MENU to exit. To cancel your timer setting, select timer 1 or 2 and press RESET while in the ON/OFF TIMER window. Performing AUTO PROGRAM will erase all TIMER settings.

Using the WIDE SCREEN MODE Menu

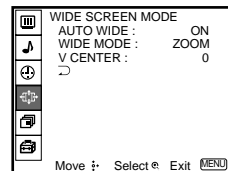

For detailed information on using the remote control to modify menu settings, refer to “Learning Menu Selection” on page 35.

To select the **WIDE SCREEN MODE** menu:

Display → Highlight \oplus → Select

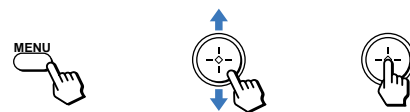

AUTO WIDE

— Automatically selects the wide screen mode

Select **ON** to automatically display the picture with an ID-1 (aspect ratio recorded) signal of 480i format in an optimum wide screen mode; normal 4:3 picture in **NORMAL**, letterbox picture in **ZOOM**, and 4:3 squeezed picture in **FULL**. (for details, see pages 28 and 29)

Select **OFF** if you want to choose the wide screen

mode manually by pressing the WIDE MODE button repeatedly.

WIDE MODE

— *Manually selects the wide screen mode*

You can select **NORMAL**, **WIDE ZOOM**, **ZOOM** or **FULL** for the 4:3 or letterbox picture to fill the 16:9 screen manually by pressing the WIDE MODE button repeatedly. (for details on each mode, see “Watching the Picture in Wide Screen Mode Automatically — AUTO WIDE” on page 28)

V CENTER

— *Adjusts the position of the picture*

Allows you to move the picture vertically within the screen (available only in ZOOM and WIDE ZOOM modes).

Move the joystick up or down to move the picture, and press \oplus .

Using the CHANNEL SET UP Menu

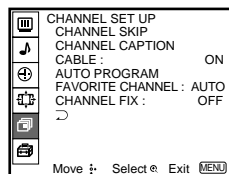

For detailed information on using the remote control to modify menu settings, refer to “Learning Menu Selection” on page 35.

To select the CHANNEL SET UP menu:

Display → Highlight → Select

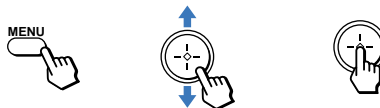

CHANNEL SKIP

— *Skips unnecessary channels*

After AUTO SET UP, you can erase unnecessary TV channels from the channel preset memory.

With the CHANNEL SKIP window open:

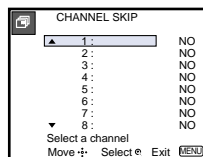

1 Move the joystick up or down to select the desired channel. You can view the channel that is selected with the CHANNEL SKIP menu in the center sub screen. You can also use CH +/- or 0-9 and ENTER buttons.

2 Press \oplus .

3 Move the joystick up or down to select **YES**, and press \oplus .
The selected channel will be erased.

If you want to re-enter the skipped channel, follow the steps above and select **NO**.

CHANNEL CAPTION

— *Easy recognition of the channel you are watching*

You can add a caption for up to 32 channels of both VHF/UHF and AUX inputs.

With the CHANNEL CAPTION window open:

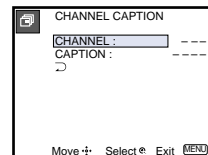

1 Press \oplus and then move the joystick up or down to select the desired channel. You can view the channel that is selected with the CHANNEL CAPTION menu in the center sub screen.

2 Press \oplus .

3 Move the joystick up or down to display the first letter or number of the caption and press \oplus to select it.

4 Repeat until up to four digits are selected.

5 Press \oplus .

To erase a caption, press RESET.

CABLE

— Cable system setting

Select **ON** if your projection TV is connected to a cable system.

Select **OFF** if your projection TV is connected to an antenna.

AUTO SET UP will set CABLE to ON automatically.

AUTO PROGRAM

— Automatic channel presetting

Select **YES** to signal the projection TV to automatically program all receivable TV channels. When all the receivable channels are stored, the lowest numbered channel is displayed.

Select **NO** to cancel AUTO PROGRAM.

FAVORITE CHANNEL

— User's favorite channels

The FAVORITE CHANNEL feature enables easy access to the eight channels that you preset (or the last channel that you were watching). (for details on how to set up this feature, see "Setting and Selecting FAVORITE CHANNEL" on this page.)

CHANNEL FIX

— Locks selection of your projection TV's input when used in conjunction with external equipment such as a cable box, AV receiver, etc.

2-6:

When the cable box is connected to the VHF/UHF input, you can fix the TV's input to one of the channels between 2 and 6. Press SAT/CABLE (FUNCTION) and then CH +/- to change the cable box channels.

AUX 2-6:

Use this when a cable box is connected to AUX, and a cable or antenna is connected to VHF/UHF.

VIDEO 1:

Use this when you have connected external video equipment (e.g. AV receiver) and you want the projection TV's input fixed to it.

OFF:

When you want to switch CHANNEL FIX off.

If the projection TV is in the AUX mode when you turn CHANNEL FIX off, press ANT to return to UHF input mode.

TIMER settings are erased when CHANNEL FIX is set.

Note:

- You cannot change channels with the TV's tuner when you set CHANNEL FIX. If you want to use the TV's tuner while fixing the TV's input to VIDEO 1, use the SET UP menu to set SELECT OUT to TV OUT. (see "SELECT OUT" on page 45)

Setting and Selecting FAVORITE CHANNEL

The FAVORITE CHANNEL feature of your projection TV enables easy access to the eight channels that you preset (or the last channel that you were watching).

Your FAVORITE CHANNEL options can be set automatically or manually.

The factory setting for FAVORITE CHANNEL is AUTO.

When FAVORITE CHANNEL is set to AUTO, the last eight channels selected with the 0-9 buttons will be set as FAVORITE CHANNEL options. If you want to input your own selections as FAVORITE CHANNEL settings, set to MANUAL.

Note:

- You can not use the FAVORITE CHANNEL when watching the signal input from VIDEO 5 (DTV) IN.

Setting FAVORITE CHANNEL manually

- 1 Select FAVORITE CHANNEL from the CHANNEL SET UP menu. (see page 41)

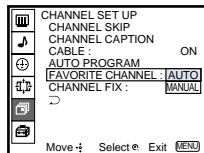

- 2 Move the joystick up or down to select MANUAL and press \oplus .

The FAVORITE CHANNEL menu will appear. If you set CHANNEL CAPTION names (e.g. CNN, HBO), they will also be displayed. (see “CHANNEL CAPTION” on page 41)

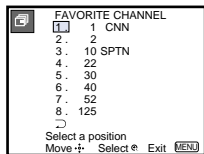
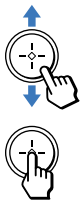

- 3 Move the joystick up or down to select a position (1–8), and press \oplus .

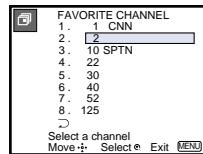
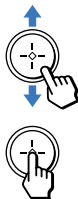

- 4 Move the joystick up or down to select a channel.

You have now selected a favorite channel.

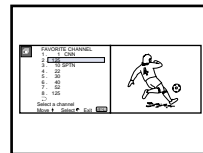

- 5 Press \oplus and use the joystick to program other favorite channels. (Follow steps 3 and 4.)

- 6 Press MENU when you have finished.

Your favorite channels are now ready for use.

Resetting FAVORITE CHANNEL choices

You have the option of returning to the FAVORITE CHANNEL screen to adjust any of your favorite channel choices.

Simply proceed as described in “Setting FAVORITE CHANNEL manually” (skip step 2 if MANUAL is already selected).

When you reach step 3, select the position you want to change and press \oplus . Press RESET to clear the channel for that position.

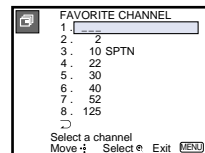

Move the joystick up or down to select a new channel.

Press MENU when you are done.

Note:

- The FAVORITE CHANNEL feature is not available for the picture input from AUX or VIDEO 5 (DTV) IN.

(continued)

Using FAVORITE CHANNEL

You can use the FAVORITE CHANNEL feature to directly select the channel you want to watch.

- 1 Press \oplus once.

The favorite channel menu and a window picture will be superimposed over the current channel. The window picture displays the channel selected from the menu.



- 2 Move the joystick up or down to select the channel that you wish to view from the menu.

The picture of the selected channel will be displayed in the window picture.

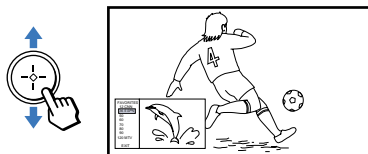

- 3 Press \oplus to select the channel.

The selected channel will be displayed for normal viewing.

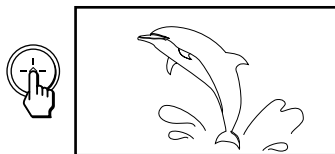

To cancel the favorite channel menu before selecting a channel, move the joystick up or down to select EXIT at the bottom of the menu and press \oplus .

Using the SET UP Menu

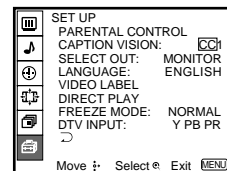

For detailed information on using the remote control to modify menu settings, refer to “Learning Menu Selection” on page 35.

To select the SET UP menu:

Display → Highlight → Select

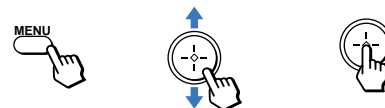

PARENTAL CONTROL

— Blocks programs unsuitable for children

Allows you to block TV programs that you feel are unsuitable for your children.

(see “Using the PARENTAL CONTROL Feature” on page 47 for details)

CAPTION VISION

— Television closed caption display

Some programs are broadcast with Caption Vision.

To display Caption Vision, select **CC 1**, **CC 2**, **CC 3**, **CC 4**, **TEXT1**,

TEXT2, **TEXT3** or **TEXT4** from the menu. Then press the **CC** button until Caption Vision is displayed.

CC 1, **CC 2**, **CC 3** or **CC 4** displays a printed version of the dialogue or sound effects of a program. (The mode should be set to **CC 1** for most programs.) **TEXT1**, **TEXT2**, **TEXT3** or **TEXT4** displays network/station information presented using either half or the whole screen.

Note:

- Poor reception of TV programs can cause errors in Caption Vision and XDS. Captions may appear with a white box or other errors instead of the intended text.

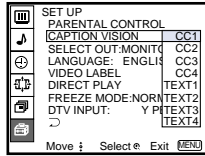

SELECT OUT

— Output signal selection from SELECT OUT

You can select the desired output signal from the SELECT OUT jacks at the rear of the projection TV.

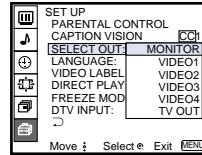

Note:

- SELECT OUT setting is not available for the inputs from VIDEO 5 (DTV) IN.

MONITOR:

Select to edit tapes while monitoring. SELECT OUT outputs the picture displayed on the screen.

VIDEO1–VIDEO4:

Select to edit tapes while viewing an input image different from that being recorded. SELECT OUT outputs the signal input to the projection TV regardless of the displayed picture on the screen.

TV OUT:

Select if you connect an AV receiver to VIDEO 1 IN. SELECT OUT outputs the signal that the TV is tuned to, regardless of the displayed picture. (see “Connecting an AV Receiver” on page 20 for connection)

If you select **TV OUT**, the following pop-up menu appears.

Select **YES** only if you have connected an AV receiver, with no other equipment, to your projection TV. You can always select the signal from the receiver by pressing TV/VIDEO once.

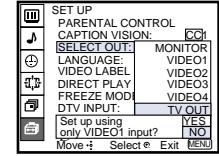

Select **NO** if you have connected multiple components to your projection TV. You can select an input (VIDEO1 – VIDEO4) with the TV/VIDEO button.

Note:

- The SELECT OUT signal is only available when the projection TV is on.

LANGUAGE

— User's preferred language

Select from available languages (**ENGLISH** or **ESPAÑOL**) to display all menus in your language of choice.

VIDEO LABEL

— Easy recognition of connected equipment (e.g. SAT, VHS, etc.)

This feature allows you to label each input mode so that you can easily identify the connected equipment (e.g. you can label VIDEO 1 IN as VHS).

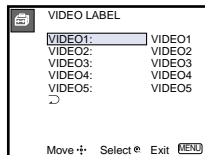

With the VIDEO LABEL window open:

- 1 Move the joystick up or down to select the input mode you want to label and press \odot .

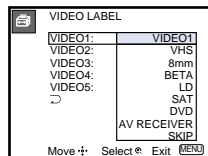

- 2 Move the joystick up or down to select the label and press \odot .

VIDEO LABEL Options:

VIDEO 1: VIDEO 1, VHS, 8mm, BETA, LD, SAT, DVD, AV RECEIVER, SKIP

VIDEO 2–4: VIDEO 2–4, VHS, 8mm, BETA, LD, SAT, DVD, SKIP

VIDEO 5: VIDEO 5, DTV, DVD, SKIP

If you select SKIP, your projection TV will skip this connection when you scan through video sources using the TV/VIDEO button.

DIRECT PLAY

— Easy operation of a connected VCR

This feature allows you to switch the input mode from the TV to a Sony VCR (MDP or DVD) and start playing by only pressing the \blacktriangleright (playback) button on the remote control. You have to set the AV 1/2/3/DVD/MDP switch on the remote control (e.g., you connect your VCR to the VIDEO 3 IN jacks and set the AV 1/2/3/DVD/MDP switch to VTR 3). With the DIRECT PLAY window open:

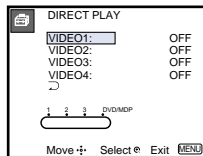

- 1 Move the joystick up or down to select the input to which your video equipment is connected, and press \odot .

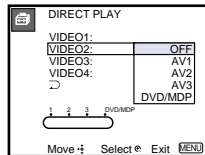

- 2 Move the joystick up or down to select the position of the AV 1/2/3/DVD/MDP switch, and press \odot .

Note:

- DIRECT PLAY setting is not available for the inputs from VIDEO 5 (DTV) IN.

FREEZE MODE

— Freeze picture mode

Useful when you need to copy down information that appears on the TV's screen.

Note:

- The FREEZE MODE feature is not available for the inputs from VIDEO 5 (DTV) IN jacks.

NORMAL:

Select to freeze the whole picture on the screen by pressing FREEZE.

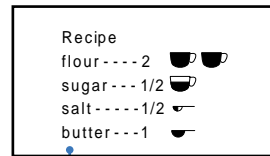

The current picture freezes.

TWIN:

Select to freeze the desired scene and display it on the left of the screen while viewing the normal picture of the current channel on the right by pressing FREEZE.

This mode is not available for PIP, P&P or CH INDEX screens.

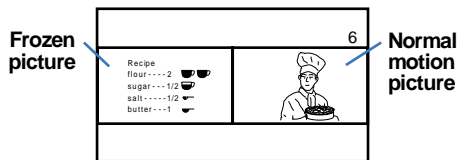

Press FREEZE again or press **OFF** to display the normal picture.

DTV INPUT

— *Input signal selection from the DTV receiver*

Select **Y PB PR** when you connect a DTV receiver to the Y/Pb/Pr jacks of VIDEO 5 (DTV) IN.

Select **R.G.B** when you connect a DTV receiver to the G/B/R/HD/VD jacks of VIDEO 5 (DTV) IN on the rear of the projection TV.

Using the PARENTAL CONTROL Feature

The TV programs and movies shown on TV are given a rating signal based on the following rating systems: Television Parental Guidelines to rate television programs (TV ratings), and Motion Picture Association of America (MPAA) Guidelines to rate movies including those shown on TV (movie ratings)

Note:

- The PARENTAL CONTROL feature is not available for the inputs from VIDEO 5 (DTV) IN.

Activating the PARENTAL CONTROL feature

First, set a password, then select your desired rating from Sony's predetermined ratings.

- Select PARENTAL CONTROL from the SET UP menu. (see page 44)

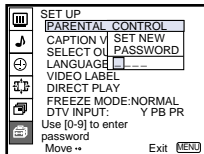

- Enter a four digit password* using the 0–9 buttons.

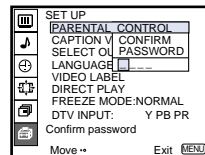

* Do not enter “4357” corresponding to “HELP” on a phone number pad. (see page 52)

- To confirm the password, re-enter the same password with the 0–9 buttons.

Your password is stored and the PARENTAL CONTROL menu automatically appears.

If you want to change the password, see page 51.

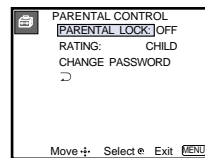

- Make sure that PARENTAL LOCK is highlighted, and press **+**.

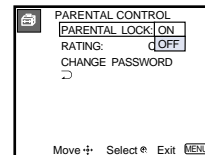

- 5 Move the joystick up or down to select ON, and press \oplus .

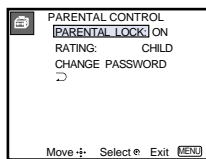
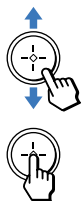

- 6 Move the joystick up or down to select RATING, and press \oplus .

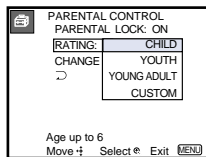
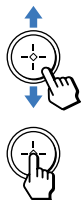

- 7 Move the joystick up or down to select a desired rating (CHILD, YOUTH and YOUNG ADULT), and press \oplus .

If you want to select the ratings from “CUSTOM,” go to step 4 of “Selecting a Custom Rating” on page 49.

- 8 Press MENU to exit the menu.

To deactivate the PARENTAL CONTROL feature

If you set PARENTAL LOCK in the PARENTAL CONTROL menu to OFF, the PARENTAL CONTROL feature will be canceled and you can view all TV programs and movies shown on TV.

- 1 Select PARENTAL CONTROL from the SET UP menu. (see page 44)

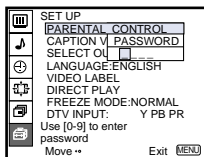

- 2 Enter your four digit password using the 0–9 buttons.

The PARENTAL CONTROL menu appears.

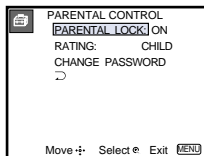

- 3 Move the joystick up or down to select PARENTAL LOCK, and press \oplus .

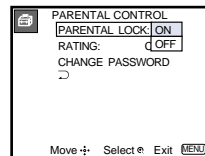

- 4 Move the joystick up or down to select OFF, and press \oplus .

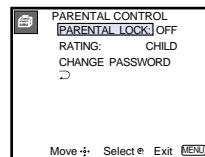

- 5 Press MENU to exit the menu.

To unlock the PARENTAL CONTROL feature temporarily

When you select a PARENTAL CONTROL program, no sound or picture except for a channel number will appear. The TV indicator is displayed. To view the program, follow the steps below.

- 1 Press ENTER to display the “Password” screen.
- 2 Enter your password using the 0–9 buttons. PARENTAL CONTROL will be canceled (PARENTAL LOCK set to OFF) until you turn your projection TV off.

Selecting a Custom Rating

If you want to select the ratings to be blocked from CUSTOM once you have activated the PARENTAL CONTROL feature (see page 47), follow the procedure below.

For a detailed description of each rating, see pages 52 and 53.

- 1 Select PARENTAL CONTROL from the SET UP menu. (see page 44)

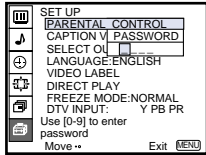

- 2 Enter your four digit password using the 0–9 buttons.

The PARENTAL CONTROL menu appears.

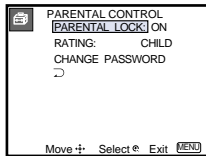

- 3 Move the joystick up or down to select RATING, and press (+).

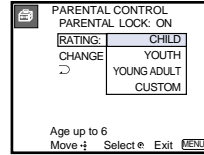

- 4 Move the joystick up or down to select CUSTOM, and press (+).

First, select a TV rating.

- 5 Move the joystick up or down to select TV RATING, and press (+).

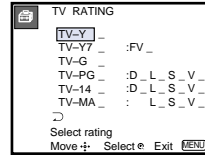

- 6 Move the joystick up or down to select the TV rating to be blocked, and press (+).

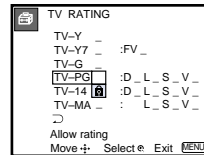

- 7 Move the joystick up or down to select , and press (+).

The  indicator automatically appears beside the selected rating and all “higher” ratings, indicating that the programs that match the ratings will be blocked.

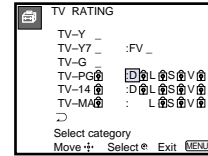

Some ratings have additional content ratings called “extenders.” The extenders are defined as follows: D (sexually suggestive Dialog), FV (Fantasy Violence), L (coarse Language), S (Sexual situations) and V (Violence). By setting the extenders, you can define additional viewing limits. For more details of extenders, see page 53.

All of the extenders included in the selected ratings will be blocked. If you wish to allow any of them to be viewed, go to step 8.

(continued)

- 8 Move the joystick left or right to select the extender to be viewed, and press \oplus .

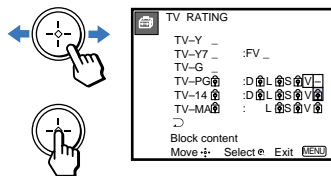

- 9 Move the joystick up or down to select “-,” and press \oplus .

“-” appears beside the selected extender, indicating that the programs that match the extender can be viewed.

If you select \oplus , \oplus is displayed to show that the programs that match the extender will be blocked again.

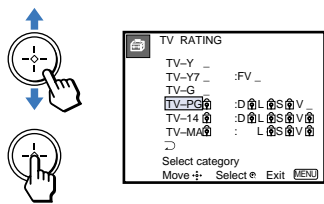

- 10 Repeat steps 8 and 9 for other extenders.

All programs that match the ratings you select and higher, except for the extenders that were canceled, will be blocked.

- 11 After setting of the TV rating is complete, move the joystick up or down to select \supset , and press \oplus .

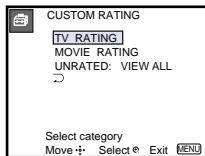

Second, select a movie rating.

- 12 Move the joystick up or down to select MOVIE RATING, and press \oplus .

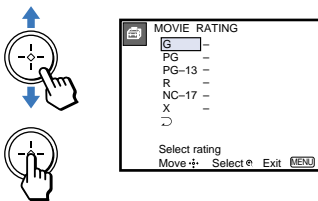

- 13 Move the joystick up or down to select the movie rating to be blocked, and press \oplus .

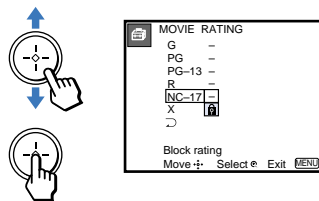

- 14 Move the joystick up or down to select \oplus , and press \oplus .

The \oplus indicator automatically appears beside the selected rating and all “higher” ratings, indicating that the programs that match the ratings will be blocked.

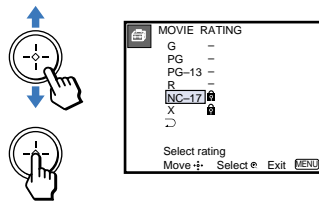

- 15 Press MENU to exit the menu.

To block TV programs and/or movies for which a rating signal is not given (NR and N/A)

For a description of the NR and N/A ratings, see page 53.

- 1 Perform steps 1–4 of “Selecting a Custom Rating” on page 49.
- 2 Move the joystick up or down to select UNRATED, and press \oplus .

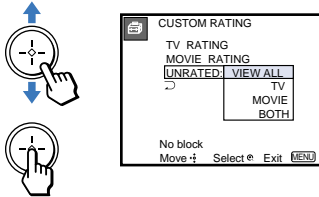

- 3 Move the joystick up or down to select the type of programs to be blocked, and press \oplus .

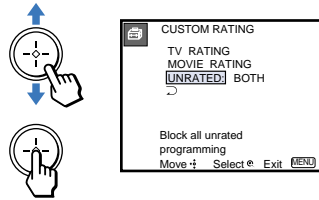

To block ...	Select ...
No program (to view any unrated TV program and movie)	VIEW ALL
Unrated TV programs	TV
Unrated movies	MOVIE
Unrated TV programs and movies	BOTH

- 4 Press MENU to exit the menu.

Changing the Password

- 1 Select PARENTAL CONTROL from the SET UP menu. (see page 44)

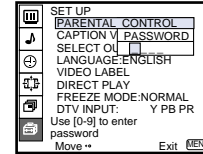

- 2 Enter your four digit password using the 0–9 buttons.

The PARENTAL CONTROL menu appears.

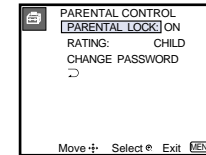

- 3 Move the joystick up or down to select CHANGE PASSWORD, and press \oplus .

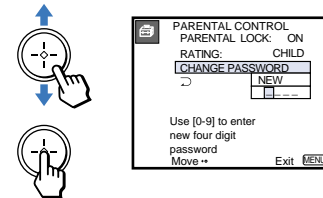

(continued)

- 4 Enter a new four digit password using the 0–9 buttons.

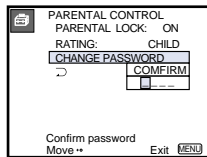

- 5 Enter the password set in step 4 again to confirm.

If you entered it incorrectly, “Password incorrect” appears.

Re-enter the correct password.

- 6 Press MENU to exit the menu.

If you have forgotten your password

In step 1 of “Changing the Password,” enter the master password “4357” (corresponding to “HELP” on a phone number pad). You can then store a new password.

Notes:

- If you entered “4357” as your password the first time, you cannot store a new password. (see step 2 of “Activating the PARENTAL CONTROL feature” on page 47)
- When you select a PARENTAL CONTROL program and the  indicator is displayed on the screen, you cannot view that program even if you enter “4357.” (see “To unlock the PARENTAL CONTROL feature temporarily” on page 48)

What the Ratings Mean

Sony’s predetermined ratings

These are original ratings that Sony predetermined according to the viewer’s age. Each rating allows you to view the certain programs, as follows.

See the center column to page 53 for a description of TV and movie ratings.

CHILD:

Suitable for children under the age of 6.

Viewable movie ratings: G, NR, and N/A

Viewable TV ratings: TV-Y, TV-G, and TV-NR

YOUTH:

Suitable for children aged 7 and older.

Viewable movie ratings: G, PG, NR, and N/A

Viewable TV ratings: TV-Y, TV-Y7, TV-G, TV-PG, and TV-NR

YOUNG ADULT:

Suitable for children aged 14 and older.

Viewable movie ratings: G, PG, PG-13, NR, and N/A

Viewable TV ratings: TV-Y, TV-Y7, TV-G, TV-PG, TV-14, and TV-NR

Movie ratings

Movie ratings are for movies (including those shown on TV) rated according to the Motion Picture Association of America (MPAA) Guidelines.

G (General Audiences—All Ages Admitted):

In G-rated films no strong words are used, the violence is at a minimum, nudity and sex scenes are not present, nor is there any drug use.

PG (Parental Guidance Suggested. Some Material May Not Be Suitable For Children):

This is a film which may need to be monitored first by parents.

PG-13 (Parents Strongly Cautioned. Some Material May Be Inappropriate For Children Under 13):

Parents are alerted to be very careful about the attendance of their under-teenage children when viewing.

R (Restricted, Under 17 Require Accompanying Parent Or Adult Guardian):

This film includes hard language, tough violence, nudity, drug abuse or other elements of concern.

NC-17 or X (No One 17 Or Under Admitted.):

This is a film that most parents would consider not suitable for children aged 17 and under. There may be violence, sex, aberrational behavior, drug abuse or other elements of concern.

NR (Not Rated):

This is a film that a producer has not rated, intending to have his film widely released.

N/A (Not Applicable):

This is a film that a producer considers outside the scope of the MPAA ratings.

Note:

- NR and N/A ratings are shown together as UNRATED in the menu.

TV ratings

TV ratings are for TV programs rated according to the Television Parental Guidelines.

TV-Y (All Children):

This program is designed for young children aged 2–6 and is appropriate for all children.

TV-Y7 (Directed to Older Children):

This program is designed for children aged 7 and above. Themes and elements in this program may include mild fantasy violence or slapstick violence, or may frighten children under the age of 7.

TV-G (General Audience):

Most parents would find this program suitable for all ages. It contains little or no violence, no strong language and little or no sexual dialog or situations.

TV-PG (Parental Guidance Suggested):

This program contains some material that parents may find unsuitable for younger children.

TV-14 (Parents Strongly Cautioned):

This program contains some material that many parents would find unsuitable for children under the age of 14.

TV-MA (Mature Audience Only):

This program is specifically designed to be viewed by adults and therefore may be unsuitable for children under the age of 17.

TV-NR (Not Rated/Unrated):

This is a program broadcast without any rating, such as news, news flashes or sports.

Note:

- The TV-NR rating is shown as UNRATED in the menu.

About the extenders of TV ratings

TV-Y7, TV-PG, TV-14 and TV-MA ratings have additional content ratings called “extenders” to define additional viewing limits. The extenders are defined as follows:

D (sexually suggestive Dialog):

Programs containing suggestive dialog, or sexual innuendo

FV (Fantasy Violence):

Programs containing cartoon violence occurring in TV-Y7 programs only

L (coarse Language):

Programs containing coarse language

S (Sexual situations):

Programs containing sexual content

V (Violence):

Programs containing violence

There may be some profanity, violence or brief nudity in these programs.

Operating Video Equipment

Setting the Manufacturer's Code

You can use the supplied remote control to operate Sony or non-Sony video equipment that has an infrared sensor.

- 1 Set the AV1/2/3/DVD/MDP switch to the input through which you would like to access your video equipment.

The following Sony equipment is preset to each input as shown below:

AV1 (303)	Beta, ED Beta VCRs
AV2 (302)	8 mm VCR
AV3 (301)	VHS VCR
DVD/MDP (751)	DVD Player

- 2 Press CODE SET, DVD/VCR (FUNCTION), and the 0-9 buttons to enter the manufacturer's code number (see the following chart), then press ENTER.

For example, to operate a Sony 8mm VCR:



If the remote control doesn't work

- See the tips on page 56.

VCR manufacturer code numbers

Manufacturer	Code
Sony	301, 302, 303
Aiwa	338
Admiral (M. Ward)	327
Audio Dynamic	314, 337
Bell & Howell (M. Ward)	330, 343
Broksonic	319, 317
Canon	309, 308
Citizen	332
Craig	315, 302, 332
Criterion	315
Curtis Mathis	304, 338, 309
Daewoo	341, 312, 309
DBX	314, 336, 337
Dimensia	304
Emerson	319, 320, 316, 317, 318, 341
Fisher	330, 334, 335, 333
Funai	338
General Electric	329, 304, 309
Go Video	340, 339, 322
Goldstar	332
Hitachi	306, 304, 305, 338
Instant Replay	309, 308
JC Penney	309, 305, 304, 330, 314, 336, 337
JVC	314, 336, 337
Kenwood	314, 336, 332, 337
LXI (Sears)	332, 305, 333, 334, 330, 335, 338
Magnavox	308, 309, 310
Marantz	314, 336, 337
Marta	332
Memorex	309, 335
Minolta	305, 304

Mitsubishi/MGA	323, 324, 325, 326
Multitech	325, 338, 321
NEC	314, 336, 337
Olympic	309, 308
Optimus	327
Panasonic	308, 309, 306, 307
Pentax	305, 304
Philco	308, 309
Philips	308, 309, 310
Pioneer	308
Quasar	308, 309, 306
RCA/PROSCAN	304, 305, 308, 309, 311, 329, 312, 313, 310
Realistic	309, 330, 328, 335, 324, 338
Sansui	314
Singer	315
Samsung	322, 313, 321
Sanyo	330, 335
Scott	312, 313, 321, 335, 323, 324, 325, 326
Sharp	327, 328
Shintom	315
Signature 2000 (M. Ward)	338, 327
Sylvania	308, 309, 338, 310
Symphonic	338
SV2000	338
Tashiro	332
Tatung	314, 336, 337
Teac	314, 336, 338, 337
Technics	309, 308
Teknica	342, 338
Toshiba	312, 311
Wards	327, 328, 335, 331, 332
XR-1000	315
Yamaha	330, 314, 336, 337
Zenith	331

MDP manufacturer code numbers

Manufacturer	Code
Sony	701
Panasonic	704
Pioneer	702

DVD Player manufacturer code numbers

Manufacturer	Code
Sony	751
Panasonic	753
Pioneer	752
RCA	755
Toshiba	754









Tips

- In some rare cases, you may not be able to operate your non-Sony video equipment with the supplied remote control. In this case, please use the equipment's own remote control.
- When you remove the batteries, the code number may revert to the factory setting.





Operating video equipment

- 1 Set the AV1/2/3/DVD/MDP switch to the input through which you would like to access your video equipment.
- 2 Press DVD/VCR (FUNCTION).
- 3 Use the VCR/DVD/MDP operation buttons indicated in the following tables.





Operating a VCR using the remote control

To turn On/Off	Press DVD/VCR (POWER). [Green Button]
To select a channel	Press the 0 – 9 buttons.
To change channels	Press CH +/-.
To record	Press  (REC) while pressing  (lower).
To play	Press  .
To stop	Press  .
To fast forward	Press  .
To rewind the tape	Press  .
To pause	Press  . Press again to resume normal playback.
To search the picture forward or backward	Press  or  during playback. Release to resume normal playback.
To change input mode	Press TV/VCR.

Operating an MDP using the remote control

To turn On/Off	Press DVD/VCR (POWER). [Green Button]
To play	Press  .
To stop	Press  .
To pause	Press  . Press again to resume normal playback.
To search the picture forward or backward	Press  or  during playback. Release to resume normal playback.
To search a chapter forward or backward	Press CH +/-.

Operating a DVD Player using the remote control

To turn On/Off	Press DVD/VCR (POWER). [Green Button]
To play	Press  .
To stop	Press  .
To pause	Press  . Press again to resume normal playback.
To step through different tracks of an audio disc	Press  to step forward or  to step backward.
To step through different chapters of a video disc	Press CH+ to step forward or CH- to step backward.
To display the Title menu	Press TITLE.
To display the DVD menu	Press DVD MENU.
To select tracks directly	Press 0-9 buttons.
To display the menu (Set up)	Press MENU.

Operating a Cable Box or Satellite Receiver (SAT)

Setting the Manufacturer's Code

You can program the supplied remote control to operate a cable box or satellite receiver.

Press CODE SET, SAT/CABLE (FUNCTION), and the 0-9 buttons to enter the manufacturer's code number (see the following chart), then press ENTER.

For example, to operate a Sony satellite receiver:



Manufacturer codenumbers (cable box)

Manufacturer	Code
Gemini	233
Hamlin/Regal	222, 223, 224, 225, 226
Jerrold/G. I.	201, 202, 203, 204, 205, 222, 206, 207, 208, 218
Macom	230, 231, 232
Magnavox	234
Oak	227, 228, 229
Panasonic	219, 220, 221
Philips	236, 237, 238, 239, 240, 241
Pioneer	214, 215
Samsung	235
Scientific Atlanta	209, 210, 211
Tocom	216, 217
Zenith	212, 213

Manufacturer code numbers (Satellite receiver)

Manufacturer	Code number
Sony	801 (preset code for remote control)
General Electric	802
RCA/PROSCAN	802

Operating a cable box or satellite receiver

- 1 Press SAT/CABLE (POWER) [Green Button] to turn on/off the cable box or satellite receiver.
- 2 Press SAT/CABLE (FUNCTION).
- 3 For other operations, refer to the operating instructions that come with the equipment. Blue-labeled buttons such as the GUIDE button can be used only with a satellite

receiver.

If the remote control doesn't work

- Try repeating the set up procedures using the other codes listed for your equipment.

To operate the projection TV

Press TV (FUNCTION). Then use the projection TV control buttons to control the projection TV.

Tips

- If more than one code number is listed, try entering them one by one until you come to the correct code for your equipment.
- If you enter a new code number, the code number you previously entered at that setting is erased.
- In some rare cases, you may not be able to operate your equipment with the supplied remote control. In this case, use the equipment's own remote control unit.
- Whenever you remove the batteries — to replace them, for example — if too much time is taken, the code numbers may revert to the factory setting and must be reset.

Troubleshooting

If, after reading the following instructions, you have additional questions related to the use of your Sony projection TV, please call one of the following numbers (English only). Customers in the continental United States contact the Sony Customer Information Service Center at: 1-800-222-SONY (7669) Customers in Canada contact the Sony Customer Relations Center at: (416) 499-SONY (7669)

The picture turns off and the TIMER/STAND BY indicator on the front panel flashes (self-diagnosis function)

- ➔ The projection TV is equipped with a self-diagnosis function. If there is a problem with your projection TV, the TIMER/STAND BY indicator on the front panel will flash repeatedly. Counting the number of flashes helps you inform qualified Sony personnel of the projection TV's condition.

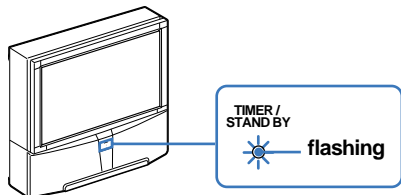

- 1 Count how many times the TIMER/STAND BY indicator flashes in total. It flashes twice at 3 seconds' intervals. If, for example, the indicator flashes twice, stops flashing for 3 seconds, and flashes twice again, that counts as twice.
- 2 Press POWER on the projection TV to turn it off, then inform qualified Sony personnel or the above Direct Response Center of the number of flashes.

No picture (screen not lit), no sound

- ➔ Make sure the power cord is plugged in.
- ➔ Operate with the buttons on both the projection TV and the remote control.
- ➔ Check to see if the TV/VIDEO setting is correct: when watching TV, set to TV, and when watching video tapes, set to VIDEO 1, 2, 3, 4 or 5.
- ➔ Try another channel. *It could be station trouble.*
- ➔ Perform AUTO SET UP again using the SET UP button to return to the factory preset condition. (see "To perform AUTO SET UP again" on page 25)
- ➔ The PARENTAL CONTROL feature is activated. (see "Using the PARENTAL CONTROL Feature" on page 47)

Remote control does not operate

- ➔ Batteries could be weak. Replace the batteries.
- ➔ Press TV (FUNCTION) when operating your projection TV.
- ➔ Make sure the projection TV's power cord is connected securely to the wall outlet.
- ➔ Locate the projection TV at least 3-4 feet away from fluorescent lights.
- ➔ Check the polarity of the batteries.

Dark, poor or no picture (screen lit), good sound

- ➔ Adjust PICTURE in the VIDEO menu. (see "PICTURE" on page 36)
- ➔ Adjust BRIGHTNESS in the VIDEO menu. (see "BRIGHTNESS" on page 36)
- ➔ Check antenna/cable connections.
- ➔ Perform AUTO SET UP again using the SET UP button to return to the factory preset condition. (see "To perform AUTO SET UP again" on page 25)
- ➔ Adjust the convergence again using the FLASH FOCUS button. (see "Adjusting the Convergence Automatically (FLASH FOCUS)" on page 25)

Good picture, no sound

- ➔ Press MUTING so that "MUTING" disappears from the screen. (see "MUTING" on page 26)
- ➔ Check the MTS setting in the AUDIO menu. (see "MTS" on page 37)
- ➔ Make sure SPEAKER is set to ALL ON or L/R OFF in the AUDIO menu. (see "SPEAKER" on page 38)
- ➔ Perform AUTO SET UP again using the SET UP button to return to the factory preset condition. (see "To perform AUTO SET UP again" on page 25)

(continued)

Cannot receive digital channels (when a DTV receiver is connected)

- ➔ Check the DTV INPUT setting in the SET UP menu. (see “DTV INPUT” on page 47)
- ➔ Check the connections between the DTV receiver and the projection TV. (see pages 12 and 13)
- ➔ Check your local listings to find out if you can receive digital broadcasts in your area.

Cannot receive upper channels (UHF) when using an antenna

- ➔ Make sure CABLE is OFF in the CHANNEL SET UP menu. (see “CABLE” on page 42)
- ➔ Use AUTO PROGRAM to add receivable channels that are not presently in the TV’s memory. (see “AUTO PROGRAM” on page 42)

No color

- ➔ Adjust the COLOR in the VIDEO menu. (see “COLOR” on page 36)
- ➔ Black and white programs cannot be seen in color.
- ➔ Perform AUTO SET UP again using the SET UP button to return to the factory preset condition. (see “To perform AUTO SET UP again” on page 25)

Only snow and noise appear on the screen

- ➔ Check the CABLE setting in the CHANNEL SET UP menu. (see “CABLE” on page 42)
- ➔ Check the antenna/cable connections.
- ➔ Make sure the channel is broadcasting programs.
- ➔ Press ANT to change the input mode. (see “ANT” on page 26)

Dotted lines or stripes

- ➔ Adjust the antenna.
- ➔ Keep the projection TV away from noise sources such as cars, neon signs or hair-dryers.

TV is fixed to one channel

- ➔ Use AUTO PROGRAM to add receivable channels that are not presently in TV’s memory. (see “AUTO PROGRAM” on page 42)
- ➔ Try turning CHANNEL FIX off. (see “CHANNEL FIX” on page 42)

Double images or ghosts

- ➔ Use a highly directional outdoor antenna or a cable (when the problem is caused by reflections from nearby mountains or tall buildings).

Cannot operate the menu

- ➔ If the item you want to choose appears in gray, you cannot select it.
- ➔ Press the projection TV’s power button off and on again.

Cannot receive any channels when using cable TV

- ➔ Check the connection with a cable box again. (see pages 9 and 11)
- ➔ Make sure CABLE is ON in the CHANNEL SET UP menu. (see “CABLE” on page 42)
- ➔ Use AUTO PROGRAM to add receivable channels that are not presently in the TV’s memory. (see “AUTO PROGRAM” on page 42)

Cannot gain enough volume when using a cable box

- ➔ Increase the volume at the cable box. Then press TV (FUNCTION) and adjust the projection TV’s volume.

CHANNEL INDEX does not display all available channels

- ➔ Make sure CABLE is ON in the CHANNEL SET UP menu. (see “CABLE” on page 42)
- ➔ Use AUTO PROGRAM to add receivable channels that are not presently in the TV’s memory. (see “AUTO PROGRAM” on page 42)

FAVORITE CHANNEL does not display your choices

- ➔ Verify that FAVORITE CHANNEL is set to MANUAL in the CHANNEL SET UP menu. (see “Setting FAVORITE CHANNEL manually” on page 43)

Some video sources do not appear when you press TV/VIDEO

- ➔ Ensure that VIDEO LABEL is not set to SKIP. (see “VIDEO LABEL” on page 46)

Recording through SELECT OUT does not function properly when recording in PIP or P&P mode

- ➔ SELECT OUT will not record both images in PIP or P&P. Only the main picture will be recorded.
- ➔ If you are recording the main picture and you switch to the sound of the sub picture using the AUDIO button, the main picture will be recorded with sound from the other program.

Cannot play shooting games

- ➔ Some shooting games which involve pointing a light beam at the TV screen with an electronic gun or rifle cannot be used with this projection TV. For details, see the instruction manual supplied with the video game software.

Specifications

Projection system

3 picture tubes, 3 lenses, horizontal in-line system

Picture tube

7-inch high-brightness monochrome tubes (6.3 raster size), with optical coupling and liquid cooling system

Projection lenses

High performance, large diameter hybrid lens F1.1

Television system

American TV standard

Channel coverage

VHF: 2–13/UHF: 14–69/CATV: 1–125

Antenna

75 ohm external terminal for VHF/UHF

Screen size (measured diagonally)

57 inches (KP-57XBR10W)

65 inches (KP-65XBR10W)

Inputs/outputs

VIDEO 1/3 IN

VIDEO 2 INPUT

S VIDEO IN (4-pin mini DIN):

Y: 1 Vp-p, 75-ohms unbalanced, sync negative

C: 0.286 Vp-p (Burst signal), 75 ohms

VIDEO (phono jack): 1 Vp-p, 75-ohms unbalanced, sync negative

AUDIO (phono jacks): 500 mVrms (100% modulation),

Impedance: 47 kilohms

VIDEO 4 IN

S VIDEO IN (4-pin mini DIN):

Y: 1 Vp-p, 75-ohms unbalanced, sync negative

C: 0.286 Vp-p (Burst signal), 75 ohms

VIDEO (phono jack): 1 Vp-p, 75-ohms unbalanced, sync negative

AUDIO (phono jacks): 500 mVrms (100% modulation),

Impedance: 47 kilohms

Y: 1 Vp-p, 75 ohms, sync negative

Pb: 0.7 Vp-p, 75 ohms

Pr: 0.7 Vp-p, 75 ohms

VIDEO 5 (DTV) IN

Maximum scanning rate: 1080i

Y: 1 Vp-p, 75 ohms, negative or tri-level sync

Pb: 0.7 Vp-p, 75 ohms

Pr: 0.7 Vp-p, 75 ohms

or

G: 0.7 Vp-p

B: 0.7 Vp-p

R: 0.7 Vp-p

HD: 0.5–5 Vp-p, 2.2 kilohms

VD: 0.6–5 Vp-p, 2.2 kilohms

Note:

The VIDEO 5 (DTV) IN jacks are not compatible with a computer's 5BNC (R/G/B/HD/VD) video output connectors.

AUDIO (phono jacks): 500 mVrms (100% modulation),

Impedance: 47 kilohms

SELECT OUT

VIDEO (phono jack): 1 Vp-p, 75-ohms unbalanced, sync negative

AUDIO (phono jacks): 470 mVrms (100% modulation),

Impedance: 47 kilohms

AUDIO (VAR) OUT (phono jacks): 950 mVrms (100% modulation)

AUDIO (FIX) OUT (phono jacks): 500 mVrms (100% modulation)

CONTROL S IN/OUT: minijacks

Speaker

Tweeter: 100 mm (4") × 2

Woofer: 160 mm (6³/₈") × 2

Center: 100 mm (4") × 2

Speaker output

Front: 20 W × 2

Center: 20 W × 1

Rear: 20 W × 2

Power requirement

120 V AC, 60 Hz

Power consumption

In use (Max.): 300 W

In standby: 1 W

Dimensions (W/H/D)

1,380 × 1,400 × 680 mm (54³/₈ × 55¹/₈ × 26⁷/₈ inches)
(KP-57XBR10W)

1,558 × 1,574 × 735 mm (61³/₈ × 62 × 29 inches)
(KP-65XBR10W)

Mass

126 kg (277 lbs 12 oz) (KP-57XBR10W)

148 kg (326 lbs 4 oz) (KP-65XBR10W)

Supplied accessories

Remote control: RM-Y907 (1)

Batteries size: AA (R6) (2)

Optional accessories

Connecting cables:

RK-G34, RK-74A, RKG-69HG, VMC-10HG, VMC-720M, VMC-810S/820S, YC-15V/30V



U/V mixer: EAC-66





Rear speakers: SS-MB115

AV receiver: STR-V555ES

Design and specifications are subject to change without notice.

Index

- A**
ACTIVE button 30, 32
ANT button 26, 31, 33
Antenna cable 8
Antenna connector 8
AUDIO button 31, 33
AUDIO menu operations 37
Audio/Video cable 7
AUTO PROGRAM 42
AUTO SET UP 24
AUX Hookup 9
- B**
BALANCE 37
BASS 37
BRIGHTNESS 36
- C**
CABLE 42
Cable box
 connection 9, 11
 operation 56
CAPTION VISION 45
CATV cable 8
CC button 27
CH +/- buttons 26
CHANNEL CAPTION 41
CHANNEL FIX 42
CHANNEL INDEX 33
CHANNEL SET UP menu
 operations  41
CHANNEL SKIP 41
Coaxial cable 7, 10
COLOR 36
- COLOR TEMP 36
Connecting Projection TV to
 amplifier that supports Dolby
 Pro Logic decoder 22
antenna 8
audio system 21
AV receiver 20
cable 8
cable box and cable 9
camcorder 16
DTV receiver 12, 13
DVD Player 18, 19
satellite receiver 14
satellite receiver and VCR 15
two VCRs 17
VCR 10, 11
- CONTROL S feature 8
Convergence 25
CURRENT TIME 40
- D**
DAYLIGHT SAVING 40
Digital TV program 28
DIRECT PLAY 46
DISPLAY button 27
DRC 1
DTV INPUT 47
DVD
 connection 18, 19
 operation 55
DYNAMIC PICTURE 37
- E**
Editing using SELECT OUT 17
EFFECT 38
  STEREO 38
 GAME 38
- LIVE 38
 PRO LOGIC 38
SRS 3D MONO 38
- F**
Factory settings 37, 38
FAVORITE CHANNEL
 selecting 42
 setting 43
FLASH FOCUS 25
FREEZE button 26, 31, 33
FREEZE MODE
 NORMAL 46
 TWIN 46
- G**
G/B/R/HD/VD 13, 47
- H**
Hookups 8
HUE 36
- J**
Joystick 23
JUMP button 26
- L**
LANGUAGE selection 45
Learning menus
 AUDIO 37
 CHANNEL SET UP 41
 SET UP 44
 TIMER 39
 VIDEO 36
- M**
MDP operation 55
Menu selection 35
MODE
 GAME 27, 36
 MOVIE 27, 36
 PRO 27, 36
 STANDARD 27, 36
 VIVID 27, 36
Movie rating 52
MTS
 MONO 37
 SAP 37
 STEREO 37
MUTING button 26
- N**
NR 37
- O**
ON/OFF TIMER 40
On-line help 23
Operating video equipment 54
- P**
PARENTAL CONTROL 47
Password 47
PICTURE 36
PICTURE MODE button 36
Picture-and-Picture (P&P) 32
Picture-in-Picture (PIP) 30
PIP/P&P operations
 ACTIVE 30, 32
 ANT 31, 33
 AUDIO 31, 33
 CH +/- 31, 33
 CHANNEL INDEX 33

FREEZE	31, 33	SHARPNESS	36	V		X	
POSITION	30	SLEEP button	27	VCR	10, 11	XDS	27
SWAP	31, 33	Sliders	23	VCR manufacturer code numbers . .	54		
TV/VIDEO	31, 32	SPEAKER		VCR operation	55	Y	
Zoom in feature	32	ALL OFF	38	VIDEO LABEL	46	Y/PB/PR.	12, 19
		ALL ON	38	VIDEO menu operations 	36		
		CENTER IN	38	VOL +/- buttons	26		
		L/R OFF	38				
R				W			
Rear speakers	6			WIDE MODE button	29		
Remote control		Specifications	60	WIDE SCREEN MODE			
Battery installation	23	Splitter	11	FULL	29		
Function buttons	26	SURROUND LEVEL	38	NORMAL	29		
Graphic illustration	inside cover	SWAP button	31, 33	Wide screen mode	28		
				WIDE ZOOM	29		
				ZOOM	29		
S		T		WIDE SCREEN MODE menu			
S Video cable	7	TEST TONE	39	operation 	40		
Safety	2	TIMER menu operations 	39				
SAP	37	TREBLE	37				
Satellite receiver operation	56	Troubleshooting	57				
Select button	23	TV (FUNCTION) button	26				
SELECT OUT	45	TV POWER button	26				
SET UP button	24	TV rating	53				
SET UP menu operations 	44	TV/VIDEO button	27				
Setting up the projection TV							
automatically	24						

If, after reading this instruction manual, you have additional questions related to the use of your Sony projection TV, please call one of the following numbers (English only).

**Customers in the continental United States contact the Sony Customer Information Service Center at:
1-800-222-SONY (7669)**

**Customers in Canada contact the Sony Customer Relations Center at:
(416) 499-SONY (7669)**