

Uniden®

UNIDEN
CORDLESS
TELEPHONES



EXAI8580 Series

At Uniden, we'll take care of you!

Thank you for purchasing a Uniden product.

If you have any questions or problems,

please do not return this product to the place of purchase.

| | |
|---|--|
| Having Trouble? | Our customer care specialists are here to help you! Visit our website at www.uniden.com or call our Customer Hotline at 1-800-297-1023 during regular business hours.* |
| Need a Part? | To order headsets, additional handsets, replacement batteries or other accessories, visit our website at www.uniden.com or call 1-800-554-3988 during regular business hours.* |
| Help for our Special Needs Customers | Uniden provides a customer service hotline for accessibility questions. If you have disability and need customer service assistance or if you have any questions about how Uniden's products can accommodate persons with disabilities, please call the accessibility voice/TTY line: 1-800-874-9314 (voice or TTY) . Accessibility information can be found on our website, www.uniden.com , under the "Accessibility" link. If your call is received outside of our business hours, leave us a message and we will call you back. |

* Central Standard Time. Detailed customer service hours are available at www.uniden.com.

Remote Operation Card

CUT

REMOTE OPERATION CARD

Uniden®

Remote access away from home

1. Call your phone number from a touch-tone phone.
2. During the outgoing message, press **[0]** and enter your PIN code. The answering system announces the number of messages stored in memory and the voice prompts. The phone stands by for you to enter a command.
3. To quit, hang up the phone.

Turn on the answering system remotely

1. Call your phone and let it ring 10 times until it answers.
2. Press **[0]** and enter your PIN code.
3. Press **[0]** then **[5]** to stop the announcement.
4. Press **[0]** then **[6]** to turn the answering system on.

1) Installing the Phone

1-1. Choosing the Best Location

To get the best performance out of your new phone, put it in the best location:

PLACE YOUR BASE

Near an AC outlet and a telephone wall jack.

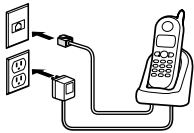

In a centrally-located open area.



TRY TO AVOID

• Microwave ovens
• Refrigerators



• Fluorescent lighting

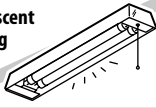

• Other cordless telephones



• TVs
• Other electronics

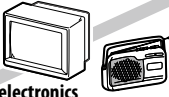

• Personal computers
• Wireless LAN equipment



• Areas with a lot of background noise



• Direct sunlight
• Extreme temperatures



• Dust
• Excessive moisture



• Shock
• Vibration



Notes: For maximum range

- Keep both the base and handset antennas free of obstruction.
- When the handset is not in use, place the handset in an upright position.
- Metal and reinforced concrete may affect cordless telephone performance.

1-2. Plug in the Battery

Use only the Uniden BT-905 rechargeable battery pack supplied with your phone.

1 Locate the battery pack, battery cover and handset.

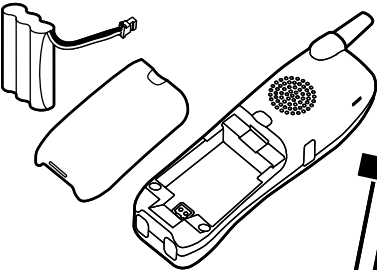

2 Line up the red and black wires on the battery pack connector with the sticker in the handset's battery compartment.

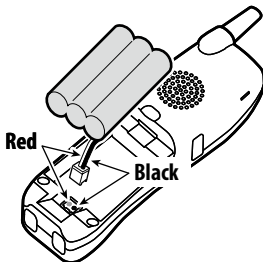

3 Place the cover over the battery compartment and slide it up into place.

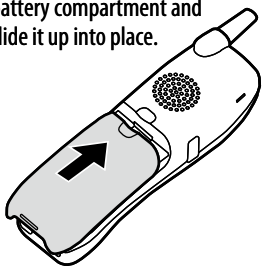

Push the battery connector in firmly. (You should hear it click into place.)

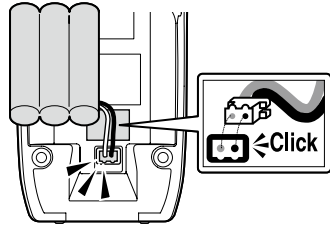

1-3. Plug in the Base

4 Put the base's AC adapter cord through the hole in the stand and connect the AC adapter to the DC IN 9V jack.

5 Route the cord through the molded wiring channel.

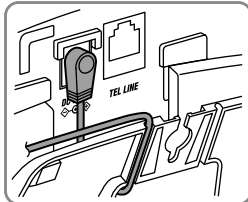

6 Connect the AC adapter to a standard 120V AC wall outlet. DO NOT use an AC outlet controlled by a wall switch.

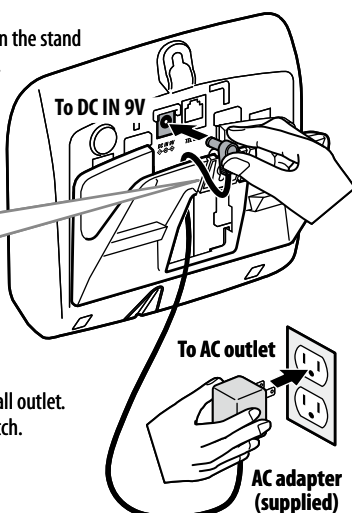

Don't put any power cord where it people might trip over it or step on it. If a power cord becomes chafed or worn out, it can create a fire or electrical hazard.

7 Place the handset in the base.

? What if the charge LED doesn't light up?

- Check AC adapter connection.
- Make sure you are not using an outlet that's controlled by a wall switch.



Note: For optimum battery life, charge your handset completely before you connect the telephone cord. The first time you charge a new battery, allow 15 to 20 hours.

1-4. Connect the Telephone Cord

8 Connect the telephone cord to the **TEL LINE** jack on the rear of the base.

9 Route the cord through the hole in the stand and into the molded wiring channel.

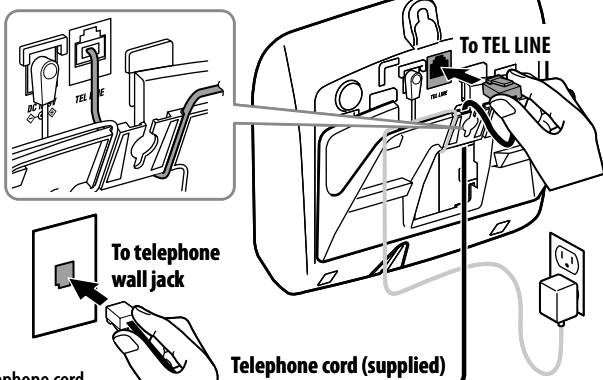

10 Connect the telephone cord to a telephone wall jack.

Note: If the telephone cord does not fit into your telephone wall jack, contact your local phone provider for assistance.

If you receive high-speed internet service through your telephone line (referred to as DSL), you should install a DSL filter between the telephone base and the wall jack. Standard telephones often can't operate correctly without a DSL filter.

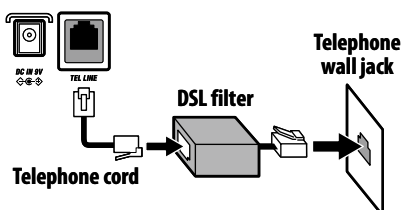

Testing the connection

11 Pick up the handset from the base and press **[TALK/flash]**. You should hear a dial tone, and the display should show **TALK**.



? What if I can't hear a dial tone?

? Check the telephone cord connection on the base.

? What if the display doesn't show **TALK**?

? Put the handset back in the base for at least five seconds. Make sure the **charge/in use** LED flashes.

12 Make a quick test call, and then press **[END]** to hang up.

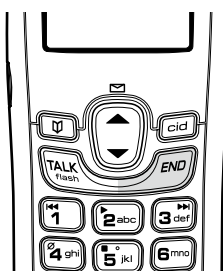

? What if the call doesn't go through?

? Try changing the dial mode (see below).

? What if there is a lot of static?

? Check the sources of interference described in section 1-1 on Choosing the best location: is the base near any of those?

Changing from tone to pulse dialing (DIAL)

Your phone can communicate with the telephone network in two different ways: tone dialing or pulse dialing. These days, most phone networks use a method called tone dialing, so your phone comes programmed for tone dialing.

If your phone company uses pulse dialing, you need to change your phone's dial settings. If you don't get a dial tone or can't connect to the telephone network, follow the steps below to modify your phone's settings:

- 1) With the phone in standby, press and hold **[cid/menu]**.
- 2) Press **[▼]** to move the pointer to **DIAL**.
- 3) Press **[select/channel]** to set the phone to pulse dialing.
- 4) Press **[END]** and **put the handset back in the base**. The handset communicates the new setting to the base.

Note: If you use pulse dialing and you need to send DTMF tones during a call (if you're using an automated response system, for example), press **[*/tone/←]** to temporarily switch to tone dialing. When the call ends, the phone automatically returns to pulse dialing mode.

Now your phone is ready to use!

1-5. Attach the Belt Clip

To attach the belt clip

Insert the tabs on the side of the belt clip into the holes on either side of the handset. Press the belt clip down until it clicks into place. (Tug on the clip to make sure it's secure.)

To remove the belt clip

Gently pull the tabs out of the holes, then slide the belt clip off of the handset.

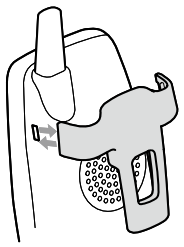

2) Getting to Know Your New Phone

2-1. A few Hints on the Manual

This manual uses several different type styles to help you distinguish between different parts of the phone:

- **Bold** text with “[]” indicates a key or button on the phone
- ALL CAPITALS indicates text on the display, such as menu options, prompts, and confirmation messages
- **lower case bold** text indicates a status light on the phone

Terms used in this manual

| | |
|----------------|--|
| Base | The main part of the phone that connects to your phone line and lets you make and receive calls. |
| CID | Caller ID is available from your telephone provider. With this service, you can see the name and number of incoming callers. |
| CIDCW | Caller ID on Call Waiting is available from your telephone provider. With this service, you can see incoming caller information while on another call. |
| Handset | A cordless handset that you use to dial the phone and talk to callers. |
| Standby | The phone is not in use. (It doesn't matter whether the handset is in the cradle: the [TALK/flash] hasn't been pressed, and there is no dial tone.) |
| Talk | A dial tone has been enabled, so you can dial and carry on a conversation with an outside party. |

Note: Illustrations in this manual are used for explanation purposes and may differ from the actual unit.

2-2. Feature Overview

- Hearing Aid Compatible
- Tone or Pulse Dialing (see section 1-4)
- Caller ID on Call Waiting (see section 3-1)
- Trilingual Menu Displays (English, Spanish, or French) (see section 3-2)
- Auto Talk (see section 3-3)
- Ringer Volume Control
 - Handset (see section 3-5)
 - Base (see section 3-5)
- Handset speakerphone (see section 4-2)
- Last Number Redial (see section 4-3)
- Earpiece Volume Control (see section 4-4)
- Page/Find Handset (see section 4-5)
- Mute Ringer (see section 4-6)
- Headset jack (see section 4-7)
- 30-number Caller ID Memory (see section 5)
- 10- Number Speed Dial Memory (see section 6)
- Chain Dialing (see section 6-7)
- Desk or Wall Mountable (see section 9)

Answering system features (see section 7,8)

- Up to 13 minutes of Recording Time
- Toll Saver (see section 7-1)
- Personal or Pre-recorded Outgoing Messages (see section 7-2)
- Trilingual voice prompts (see section 7-1)
- Handset access to answering system (see section 7-4)
- Time and Day Announcement (see section 7-4, 8-2)
- Call Screening (see section 7-5)
- Conversation Recording (see section 7-6)
- Voice Memo (see section 7-7)
- Remote Message Retrieval (see section 8)

2-3. Parts of the Handset

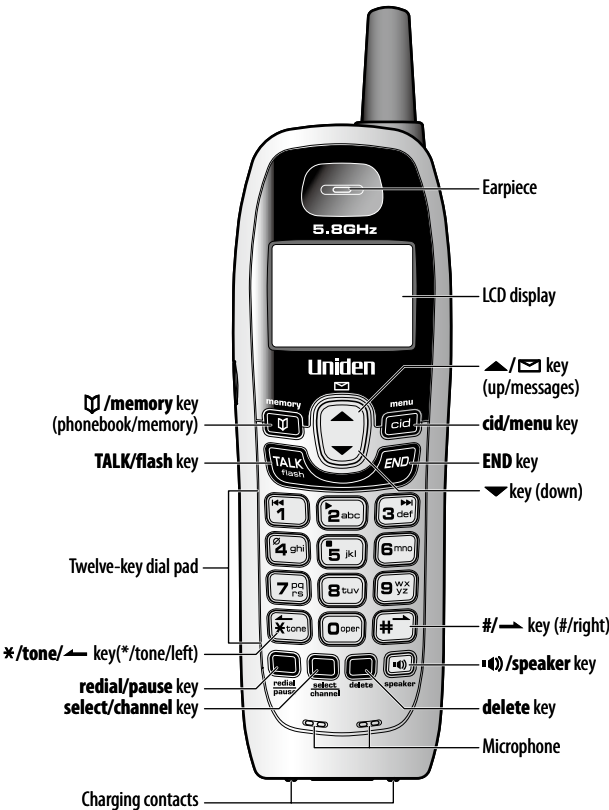

Using the handset menu

- To open the handset menu, press and hold [cid/menu] for two seconds.
- The arrow pointer on the left side of the line shows which menu item is currently highlighted. Use [▲/☑] to move the pointer up and [▼] to move the pointer down.
- If the phone beeps and stays on the same line, it means you have reached the top or bottom of the list.
- Press [select/channel] to rotate through the available options for the highlighted menu item.
- Press [END] to exit the menu.

Note: You can find detailed information on the handset menu in section 3 on Setting Up Your Phone and section 4 on Using Your Phone.

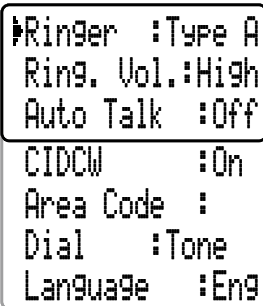

2-4. Parts of the Base

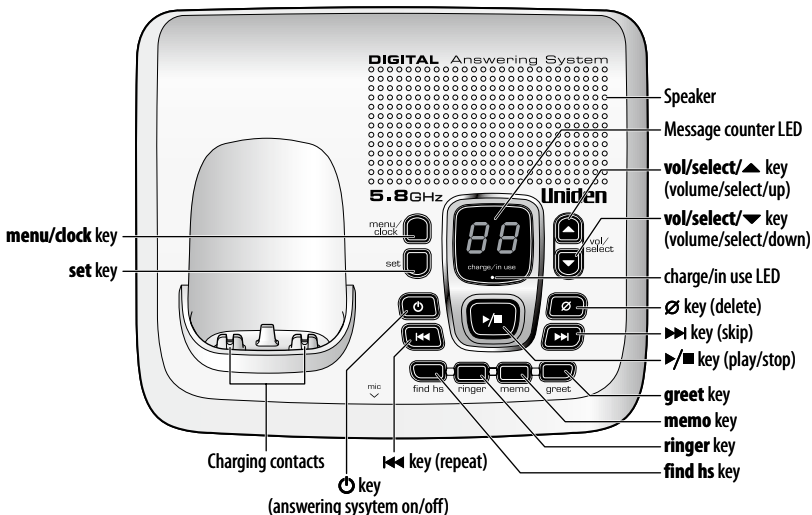

Note: For information on the base menu, see section 7 on Using Your Answering system.

3) Setting Up Your Phone

Your phone has four basic options that you need to set up first. You should only have to set these options once, and you may not have to change any of them:

- Dial mode (tone or pulse dialing)
- CIDCW (Caller ID on Call Waiting)
- Language
- Auto talk

You might change two handset-specific options --ringer type and ringer volume -- and one base setting --ringer volume --more often, depending on the situation. There's another option, area code, that you should only set if you can use seven-digit dialing (see section 5-3 on Using Seven Digits Instead of Ten).

3-1. Activating Caller ID on Call Waiting (CIDCW)

You must subscribe to Caller ID service through your local telephone provider to use this feature.

Caller ID allows you to see the name and number of the calling party before you answer the phone. Caller ID on Call Waiting (CIDCW) lets you see the name and number of a call that comes in when you are on the line.

- 1) With the phone in standby, press and hold [cid/menu].
- 2) Press [▼] to move the pointer to CIDCW.
- 3) Press [select/channel] to toggle and turn on Caller ID on Call Waiting.
- 4) Press [END] and **put the handset back in the base**. The handset communicates the new setting to the base.

3-2. Setting the Display Language (LANGUAGE)

The handset menus can use English (ENG, default), French (FR) or Spanish (ESP).

- 1) With the phone in standby, press and hold [cid/menu].
- 2) Press [▼] to move the pointer to LANGUAGE.
- 3) Press [select/channel] to select ENG, FR, or ESP.
- 4) When the display shows the language you want, use [▲/☑] and [▼] to move the pointer to another menu item.

OR

If you're finished, press [END] to return the handset to standby.

Note: To change the language used by the answering system, see Section 7-1 on Setting Up the Answering System.

3-3. Activating AutoTalk (AUTO TALK)

With Auto Talk, you can answer the phone just by picking up the handset from the cradle: you don't have to press any keys. If the handset is already off the cradle, Auto Talk also lets you answer by pressing any key on the twelve-key dial pad (instead of just [TALK/flash]).

- 1) With the phone in standby, press and hold [cid/menu].
- 2) Press [▼] to move the pointer to AUTO TALK.
- 3) Press [select/channel] to turn Auto Talk on.
- 4) Use [▲/☑] and [▼] to move the pointer to another menu item.

OR

If you're finished, press [END] to return the handset to standby.

3-4. Setting the Ringer Tone (RINGER)

- 1) With the phone in standby, press and hold [cid/menu].
- 2) Press [select/channel] to rotate through the four available ring tones (A, B, C, and D). As you switch to the next ring tone, the handset sounds a sample of that ringer.
- 3) When you hear the ringer you want, use [▲/☒] and [▼] to move the pointer to another menu item.
OR
If you're finished, press [END] to return the handset to standby.
The handset will use the new ring tone starting with the next incoming call.

3-5. Setting the Ringer Volume

On the handset (RING.VOL.)

- 1) With the phone in standby, press and hold [cid/menu].
- 2) Press [▼] to move the pointer to RING VOL.
- 3) Press [select/channel] to rotate through the three available volume levels (HIGH, LOW, and OFF). As you switch to the next volume level, the handset sounds a sample of the current ring tone at that level.
- 4) When you hear the volume level you want, use [▲/☒] and [▼] to move the pointer to another menu item.
OR
If you're finished, press [END] to return the handset to standby.
The handset will use the new ringer volume starting with the next incoming call.

Note: If you set the ring volume to OFF, the handset won't ring. The base will ring according to its ringer settings.

On the base

You can change the base ringer volume with the phone in standby or while the phone is already ringing.

- 1) On the base, press [ringer]. The message counter display shows the current volume level (Hi = high, Lo = low, OF = off) and sounds the ringer at that level. If the volume level is off, the voice prompt announces "Ringer off."
- 2) Press [ringer] immediately to switch to the next volume level. As you switch to the next volume level, the base sounds the ringer at that level and shows that level in the message counter display.
- 3) When you hear the ringer volume level you want to use, stop pressing [ringer].

Note: If you turn the ringer volume off, the base won't ring. The handset will ring according to its ringer settings.

4) Using Your Phone

4-1. Making and Receiving Calls

| | ...from the handset | ...from the handset speaker phone |
|----------------------------|--|--|
| To make a call... | <ol style="list-style-type: none"> 1) Pick up the handset. 2) Press [TALK/flash]. 3) Listen for the dial tone. 4) Dial the number. OR <ol style="list-style-type: none"> 1) Pick up the handset. 2) Dial the number. 3) Press [TALK/flash]. | <ol style="list-style-type: none"> 1) Pick up the handset. 2) Press [☎]. 3) Listen for the dial tone. 4) Dial the number. OR <ol style="list-style-type: none"> 1) Pick up the handset. 2) Dial the number. 3) Press [☎]. |
| To answer a call... | <ol style="list-style-type: none"> 1) Pick up the handset. (If AutoTalk is on, the phone automatically answers when you pick it up from the cradle.) 2) Press [TALK/flash]. (If AutoTalk is on, you can also press any key on the twelve-key dial pad.) | <ol style="list-style-type: none"> 1) Pick up the handset. 2) Press [☎]. |
| To hang up... | Press [END] or return the handset to the cradle. | |

4-2. Switching a Call to the Handset Speakerphone

To switch a normal call to the speakerphone, press [☎] on the handset. To switch back to a normal call, press [☎] again.

4-3. Redialing the Last Dialed Number

- | | | |
|---|----|---|
| 1) Pick up the handset from the cradle. | OR | 1) Pick up the handset from the cradle. |
| 2) Press [redial/pause]. | | 2) Press [TALK/flash] or [☎]. |
| 3) Press [TALK/flash] or [☎]. | | 3) Listen for the dial tone. |
| | | 4) Press [redial/pause]. |

4-4. Adjusting the Speaker Volume

You can change the speaker volume on the base, the handset earpiece, or the handset speakerphone.

On the base

You can choose from ten volume levels (☒ - ☒) for the base speaker. Press [vol/select/▲] to make the volume louder or [vol/select/▼] to make it softer.

- Notes:
- You can't change the speaker volume when you're using the base setup menu. Exit the menu, and then change the volume.
 - If you hear three quick error beeps, it means the speaker is already at the lowest (☒) or highest (☒) volume level.

On the handset

When you are on a normal call, press [▲/☒] to make the earpiece louder or [▼] to make it softer.

The handset display shows the current volume level for the earpiece.

When you are using the speakerphone, use [▲/☒] or [▼] to change the speaker volume. The handset display shows the current volume level for the handset speakerphone.

There are four volume levels: LOW, MEDIUM, HIGH, and MAXIMUM.

- Notes:
- The handset earpiece and the handset speakerphone have separate volume settings.
 - If you hear three quick error beeps, it means the earpiece or speaker is already at the lowest (LOW) or highest (MAXIMUM) volume level.

4-5. Finding the Handset

To locate the handset, press **[find hs]** on the base. The handset will beep for sixty seconds.

To cancel paging, press **[find hs]** again, press any key on the handset, or put the handset back in the base.

4-6. Muting the Ringer

When the phone is ringing, you can mute the ringer on the base or the handset. Muting stops the ringer for the current call only; the ringer will sound with the next incoming call.

On the handset

You can only mute the handset ringer if the handset is already off the cradle when the handset starts ringing. Press **[END]** to mute the incoming ring.

On the base

Press **[▶/■]** to mute both the ringer and the answering system speaker. To turn the ringer back on for this call, press the **[ringer]**.

Note: When you turn the ringer back on, the answering system speaker is still off; to turn the answering system speaker back on, press **[vol/select/▲]** or **[vol/select/▼]**.

4-7. Using an Optional Headset

- To install a headset, remove the headset jack cover and insert the headset plug into the headset jack.
- When you connect a headset, the earpiece and speakerphone are automatically muted. If you want to re-activate the earpiece or speakerphone, remove the headset plug.
- You will still make and receive calls as usual: just use your headset to talk to the caller once the call connects.
- You can purchase headsets from our website at www.uniden.com or by calling our Parts Department (See the back cover page).

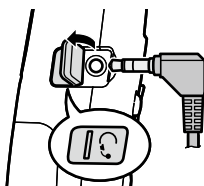

5) Using Caller ID and Call Waiting

If you subscribe to Caller ID from your phone company, your phone will show you the caller's phone number and name (if available) whenever a call comes in. If you subscribe to both Call Waiting and Caller ID, the phone also shows you the name and the number of any call that comes in while you're on the line.

| | |
|----------------------------|--------------|
| The date and time received | 5/11 12:30PM |
| Caller's name | Jane Smith |
| Caller's Phone Number | 214-555-1234 |

Note: If you answer a call before the Caller ID record is received (for example, before the second ring), the Caller ID record will not appear.

The phone stores the Caller ID information for up to thirty incoming calls - even unanswered calls. If the phone receives more Caller ID records than it can store, the oldest record in the list is automatically deleted. For information on storing Caller ID records in the phonebook, see section 6-6.

5-1. Reviewing the Caller ID Record List

You can review the Caller ID list when the handset is in standby or during a call.

- 1) Press **[cid/menu]**. The summary screen displays the total number of CID records along with the number of new CID records (that is, calls that you haven't reviewed yet).
- 2) Use **[▼]** to scroll through the records from the latest to the earliest, or use **[▲/☑]** to scroll through the records from the earliest to the latest.
- 3) Press **[cid/menu]** to exit the Caller ID list.

| |
|-----------|
| Caller ID |
| New :01 |
| Total:17 |

For new Caller ID records, the phone keeps a count of the number of calls received from the same caller (instead of saving the information multiple times). The Caller ID record shows the time and date of the most recent call from that number, and the number of calls appears next to the received time. The phone only maintains this count for new or "unviewed" records: once you review that record, the number is cleared.

| |
|------------------|
| 12/30 11:59PM 01 |
| Jane Smith |
| 214-555-1234 |

5-2. Making a Call from the Caller ID List

- 1) With the phone in standby, press **[cid/menu]**.
- 2) Use **[▲/☑]** or **[▼]** to find the Caller ID record you want to call.
- 3) If you need to add or delete a "1" from the displayed phone number, press **[1]**.

What's this "add or delete a 1" about?

- Any phone number in the Caller ID records might (or might not!) have a "1" at the front, depending on how different phone companies send the Caller ID information.
- The phone dials the number exactly as it appears in the Caller ID record.
- If the phone number is a long distance or toll call, but the Caller ID record does not have a "1" in front of the number, press **[1]** to add it.
- If the phone number is a local or non-toll call, but the Caller ID record has a "1" in front of the number, press **[1]** to delete it.

- 4) Press **[TALK/flash]** or **[☎]** to dial the number.

Note: You can also press **[TALK/flash]** or **[☎]** before you access the Caller ID list. When you come to the phone number you want to dial, press **[select/channel]**.

5-3. Using Seven Digits Instead of Ten

If you can make a local call by dialing only seven digits instead of ten, you can tell the phone to hide your local area code in the Caller ID list; any calls from outside your area code will show all ten digits.

Entering your area code

- 1) With the phone in standby, press and hold **[cid/menu]**.
- 2) Press **[▼]** to move the pointer to select AREA CODE. If an area code was already stored, the handset will display it.
- 3) Press **[select/channel]** to edit the area code.

- 4) Use the number keys ([0] – [9]) to enter all three digits of your area code.
If you make a mistake, press **[delete]** to erase the last digit.
 - 5) When the number is correct, press **[select/channel]**. A confirmation tone sounds.
 - 6) Press **[END]**. The handset returns to standby.
- The phone uses the stored area code as a filter. When a call comes in, the phone compares the incoming area code to the code programmed in the handset. If the two codes match, the handset hides the area code in the Caller ID list.
 - When you're in the Caller ID list, you can show the hidden area code by pressing **[3]**. Press **[3]** again to hide the area code.

When you dial from a Caller ID list or store a Caller ID record in the phonebook, the phone dials or stores the digits exactly as they appear on the display. If you need to use ten digits, be sure to press **[3]** to show the area code before you dial or store the number. See Section 6-6 Storing Caller ID Records in the Phonebook.

5-4. Deleting Caller ID Records

- If you get an incoming call or page, the operation is canceled.

| To delete one Caller ID record | To delete all the Caller ID records |
|--|---|
| 1) With the phone in standby, press [cid/menu] . | 1) With the phone in standby, press [cid/menu] . |
| 2) Use [▲/☐] or [▼] to find the Caller ID record you want to delete. | 2) From the CID summary screen, press [delete] . The display asks you to confirm. |
| 3) Press [delete] . The display asks you to confirm. | 3) To delete all the records, use [▲/☐] to move the pointer to YES. Or, if you changed your mind, leave the pointer at NO. |
| 4) To delete the record, leave the pointer at YES. Or, if you changed your mind, press [▼] to move the pointer to NO. | 4) Press [select/channel] to confirm. |
| 5) Press [select/channel] to confirm. | |

5-5. Using Call Waiting

If you subscribe to Call Waiting and a second call comes in when you are on the phone, the phone sounds a call waiting tone. If you also have Caller ID service, the phone shows the Caller ID information for the incoming call. To put the original call on hold and switch to the waiting call, press **[TALK/flash]**. After a slight pause, you are connected to the new caller. Press **[TALK/flash]** again to switch back to the original caller.

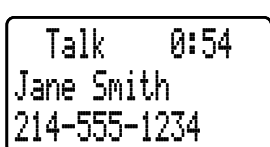

OR

To hang up and answer the new call, press **[END]**. The phone disconnects the original caller and switches to the new caller.

6) Using the Phonebook (speed dial memory)

- If you enter phone numbers (along with names) into the handset's phonebook/speed dial memory, you can dial them with just two key presses.
- The handset can store ten different phonebook entries (corresponding to 0 through 9 on the number keypad).
- You can use the phonebook to store any number up to twenty digits. This is useful if you have a series of digits that you need to enter after your call connects, such as an access code or account number (See section 6-7 on Chain Dialing).
- When you're editing the phonebook, you must press a key within thirty seconds or the phone will return to standby.

6-1. Entering a New Number into the Phonebook

- 1) With the phone in standby, press **[☐/memory]** to open the phonebook list.
- 2) Enter a number ([0] – [9]) or press **[▲/☐]** or **[▼]** to find a phonebook entry that shows <EMPTY> beside it, and press **[select/channel]**. The handset opens the STORE NAME screen.
- 3) Use the letters above the number keys to enter a name for this phonebook entry. Press **[select/channel]** when you're finished (or if you don't want to enter a name). The handset opens the STORE NUMBER screen.

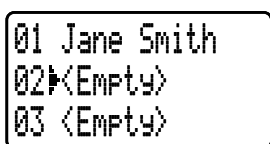

Entering text in your phone

The letters above the number appear in order: press the 2 key once for A, twice for B, and three times for C. You can also enter lower case letters and symbols (see the table below for all the available characters and what keys to press to enter them).

For example, to enter *Mom*

- 1) Press **[6]** once to enter *M*.
 - 2) Press **[#/←]** to move the cursor to the right.
 - 3) Press **[6]** six times to enter *o*.
 - 4) Press **[#/←]** to move the cursor to the right.
 - 5) Press **[6]** four times to enter *m*.
- New characters are inserted next to the character highlighted by the blinking cursor.

| keys | Number of times key is pressed | | | | | | | | |
|--------|--------------------------------|---|---|---|---|---|---------|---|---|
| | 1 | 2 | 3 | 4 | 5 | 6 | 7 | 8 | 9 |
| 1 | 1 | | | | | | | | |
| 2 abc | A | B | C | a | b | c | 2 | | |
| 3 def | D | E | F | d | e | f | 3 | | |
| 4 ghi | G | H | I | g | h | i | 4 | | |
| 5 jkl | J | K | L | j | k | l | 5 | | |
| 6 mno | M | N | O | m | n | o | 6 | | |
| 7 pqrs | P | Q | R | p | q | r | s | 7 | |
| 8 tuv | T | U | V | t | u | v | 8 | | |
| 9 wxyz | W | X | Y | Z | w | x | y | z | 9 |
| 0 oper | * | # | - | & | (|) | (blank) | 0 | |

- To enter between characters, move the cursor and enter a new character.
- Use **[*/tone/←]** and **[#/←]** to move the cursor to the desired location.
- To enter two characters controlled by the same key, enter the first character, move the cursor to the right, then enter the second character.
- When the cursor is on the end of the digit, press **[delete]** to delete characters from last one as needed.
- If you made a mistake, move the cursor to the incorrect character and press **[delete]**. Then enter the correct character.
- To delete all the characters, press and hold **[delete]**.

- 4) Use the number keypad to enter the phone number. Press **[select/channel]** when you're finished. The handset sounds a confirmation tone and displays MEMORY STORED.
 - The number can be up to twenty digits.
 - If this phone number is a long distance call, be sure to include the "1" in front of the phone number.
 - If you need the phone to wait before dialing the next digit (for example, to enter an extension number or access code), press **[redial/pause]** to insert a two-second pause between digits. The display shows a P where the phone will pause. You can add as many pauses as you want anywhere in the phone number, but each pause does count as a digit.



- 5) After a few seconds, the handset goes back to the phonebook list. Use **[▲/☑]** and **[▼]** to select another phonebook entry.

OR

Press **[☒/memory]** to exit the phonebook. The phone returns to standby.

6-2. Finding Phonebook Entries

If you know the number of the phonebook entry you're looking for:

- Press and hold the number key (0 through 9) assigned to that phonebook entry. The handset displays the name and phone number saved for that phonebook entry. If the entry has no number, the handset displays : <EMPTY> PRESS SELECT TO EDIT.
- If the number you picked wasn't the right phonebook entry, just use **[▲/☑]** and **[▼]** to scroll through the phonebook entries. Stop scrolling when you see the phonebook entry you want.

If you don't know the number of the phonebook entry you're looking for:

- Press **[☒/memory]** to open the phonebook list.
- Use **[▲/☑]** and **[▼]** to scroll through the phonebook entries. Stop scrolling when you see the phonebook entry you want.

6-3. Making a Call from the Phonebook

With the phone in standby, find the phonebook entry you want to call (See section 6-2 on Finding Phonebook Entries). Then press **[TALK/flash]** or **[☎]** to dial the number.

You can also press **[TALK/flash]** or **[☎]** and then find the phonebook entry you want to call, and press **[select/channel]**.

6-4. Editing a Number in the Phonebook

- 1) With the handset in standby, find the phonebook entry you want to edit (See section 6-2 on Finding Phonebook Entries).
- 2) Press **[select/channel]** to open the MENU screen.
- 3) On the MENU screen, use **[▼]** to move the pointer to EDIT MEMORYXX, and press **[select/channel]**.
- 4) The handset takes you to the STORE NAME screen from Step 2 of section 6-1 on Entering a New Number into the Phonebook: just follow the same steps from there.

6-5. Deleting a Number from the Phonebook

- 1) With the handset in standby, find the phonebook entry you want to delete (See section 6-2 on Finding Phonebook Entries).
- 2) Press **[select/channel]** to open the MENU screen.
- 3) On the MENU screen, use **[▼]** to move the pointer to DELETE MEMORYXX, and press **[select/channel]**. The handset asks you to confirm.
- 4) To delete the entry, use **[▲/☑]** to move the pointer to YES and press **[select/channel]**. The handset sounds a confirmation tone and goes back to the phonebook list.

OR

If you changed your mind, leave the pointer at NO and press **[select/channel]**. The handset returns to standby.

6-6. Storing Caller ID Records in the Phonebook

- 1) With the phone in standby, press **[cid/menu]**.
 - 2) Use **[▲/☑]** or **[▼]** to find the Caller ID record you want to save.
- Note: Remember, the phone stores the digits exactly as they appear on the display. If you need to add or delete a "1" from the displayed phone number, press **[1]**. (You can always go back and edit the phone number later.)
- 3) Press **[☒/memory]** to open the phonebook.
 - 4) Find the phonebook entry number you want to use (See section 6-2 on Finding Phonebook Entries).
 - 5) Press **[select/channel]** to store the Caller ID information to the phonebook and return to the Caller ID list.

Note: If this number already has a phonebook entry saved to it, the handset asks if you want to replace the existing entry. Select YES to replace the existing entry with the new one, or select NO to cancel and keep the existing entry. The display returns to the Caller ID list.

6-7. Chain Dialing

If you often have to enter a series of digits or some type of code number during a call, you can save that code number to a phonebook entry. When your call connects, just use the phonebook speed dial to transmit the saved code number. (This is referred to as chain dialing.)

- 1) Enter the code number (up to twenty digits) into the phonebook (See section 6-1 on Entering a New Number into the Phonebook). Be sure to enter the code number into the phonebook exactly as you would enter it during a call.
- 2) During a call, when you hear the prompt that tells you to enter the code number, press **[☒/memory]** to open the phonebook.
- 3) Find the phonebook entry number you want to use (See section 6-2 on Finding Phonebook Entries).
- 4) Press **[select/channel]**. The phone sends the digits of the code number exactly as you saved them in the phonebook entry.

7) Using Your Answering System

7-1. Setting Up the Answering System

Here are some general tips on using your answering system menu:

- To open the answering system menu, press **[menu/clock]** on the base.
- The voice prompt announces each menu item. Press **[menu/clock]** to go to the next item. If you are already at the last menu item, the base beeps and returns to standby.
- When you hear the menu item you want, use **[vol/select/▲]** and **[vol/select/▼]** to scroll through the options for that menu item. To quickly scroll through the options when setting the time or security code, press and hold **[vol/select/▲]** or **[vol/select/▼]**.
- Press **[set]** to select the current option.
- If you wait longer than five seconds before pressing a key, the system returns to standby. When you're setting the time, you have two minutes before the system exits the menu.
- Press **[▶/■]** to exit the menu and return to standby.
- If you receive an incoming call or if you press the **[TALK/flash]**, the system automatically exits the menu.

The flow chart below shows the answering system menu items and the available options:

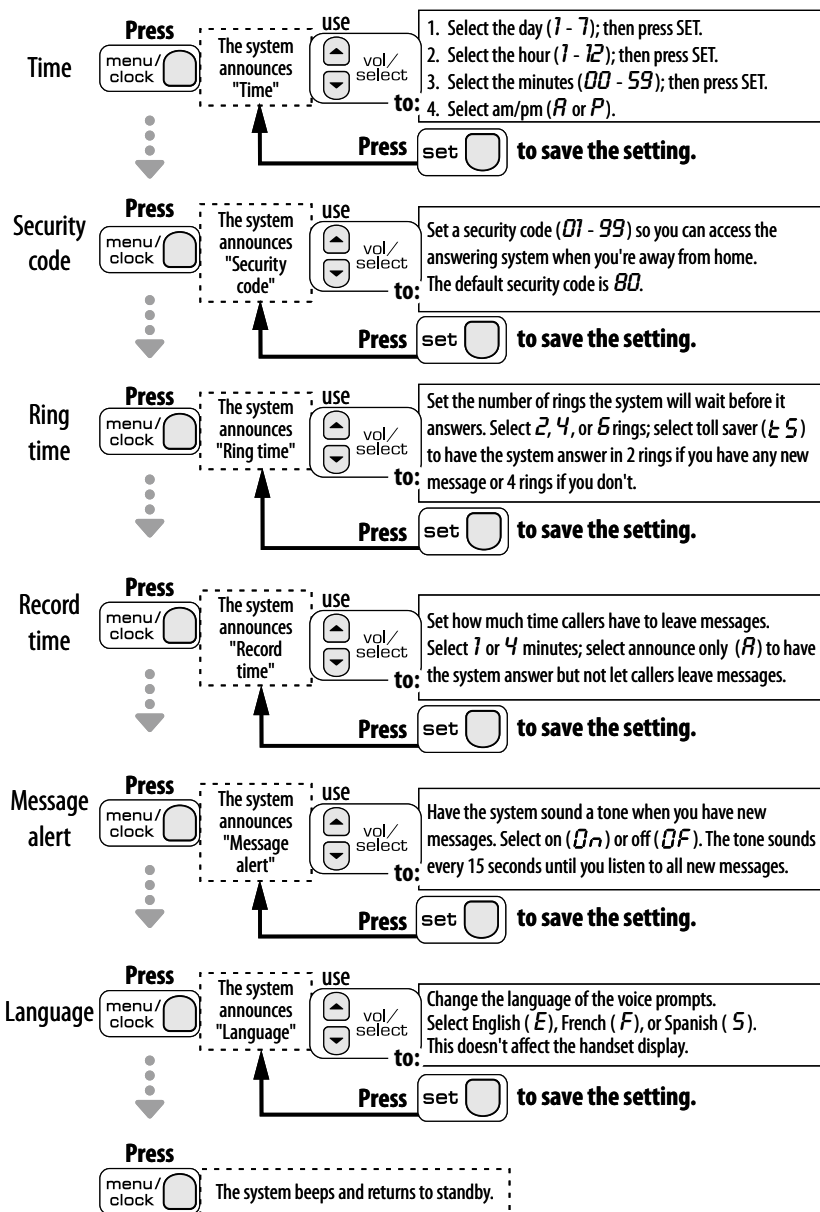

7-2. Setting Your Outgoing Message (Greeting)

The answering system comes with two prerecorded outgoing messages, or *greetings*. The default greeting says: "Hello, no one is available to take your call. Please leave a message after the tone."

If you change the answering system to announce only (so it won't record any messages), the greeting changes to:

"Hello. No one is available to take your call. Please call again."

Recording your own greeting

When you record your own greeting, the answering system does not delete the two prerecorded greetings: it saves your greeting along with them.

- 1) With the phone in standby, press and hold **[greeting]**. The base beeps and announces "Record greeting."
- 2) Start recording your message. Your greeting must be at least two seconds but no more than thirty seconds. The message counter display counts down from thirty so you know how many seconds you have left.
- 3) When you are finished recording, press **[greeting]**, **[▶/■]** or **[set]**. The base sounds a confirmation tone, plays your greeting back for you.

Selecting a greeting

You can switch between the prerecorded greeting and your personal greeting any time:

- 1) With the phone in standby, press **[greeting]** to hear the currently-selected greeting.
- 2) While the greeting is playing, press **[greeting]** again to switch to the other greeting. After the greeting finishes playing, the base sounds a confirmation tone.

Deleting your personal greeting

Press **[greeting]**. While the currently-selected greeting is playing, press **[∅]**. The base deletes the personal greeting and announces "Greeting has been deleted."

Note: You cannot delete the prerecorded greetings. Pressing **[∅]** always deletes the personal greeting.

7-3. Turning the Answering System On and Off

| | From the base | From the handset |
|--------------------|--|---|
| Turning On | With the phone in standby, press [⏻]. The message counter shows the number of received messages. | With the phone in standby, press [▲/✉] to access the answering system. Press [6]. |
| Turning Off | With the phone in standby, press [⏻]. The message counter display turns off. | With the phone in standby, press [▲/✉] to access the answering system. Press [9]. |

Note: If the answering system announces “No remaining time” when you turn it on, the memory is full (the message counter also shows $F L$). The answering system can't record any new messages until you delete some of the saved ones.

7-4. Listening to Your Messages

- The message counter shows the number of messages stored in memory.
- If you have any messages that you haven't listened to yet, the message counter shows the number of these new messages only.
- The answering system plays your **new messages** first; after you listen to all the new messages, you can play any old messages.
- You cannot delete new messages. If you try to delete messages before listening to them, the answering system will beep and say “Please playback all messages.”

You can listen to your messages from the base or from the handset:

| | From the base | From the handset |
|----------------------------------|--|---|
| Playing new messages | Press [▶/■]. The system announces the number of new and old messages, then plays your new messages. | Press [▲/✉]. The system announces the number of new and old messages. Then press [▶/2] to play your new messages. |
| Repeating a message | Press [⏮] once to restart the current message. Press [⏮] repeatedly to review previous messages. Press and hold [⏮] to rewind through the current message. | Press [⏮/1] once to restart the current message. Press [⏮/1] repeatedly to review previous messages. |
| Skipping a message | Press [▶▶] to go to the beginning of the next message. Press and hold [▶▶] to fast forward through the current message. | Press [▶▶/3] to go to the beginning of the next message. |
| Deleting a message | While a message is playing, press [∅]. The message is permanently deleted. | While a message is playing, press [∅/4]. The message is permanently deleted. |
| Deleting all messages | While the phone is in standby, press [∅]. When the system asks you to confirm, press [∅] again. All messages are permanently deleted. | Not available. |
| Playing old messages | After you listen to your new messages, press [▶/■] again to play your old messages. | After you listen to your new messages, press [▲/✉] followed by [▶/2] to play your old messages. |
| Ending the message review | Press [▶/■]. The phone returns to standby. | Press [■/5] to stop. Press [END] to return to standby. |

Turning off the message alert tone

When all new messages are played back, the message alert tone will automatically deactivate. The tone will not deactivate until all new messages are played back. To quickly turn off the tone, press any key on the base.

7-5. Screening Calls

- If you let the answering system answer an incoming call, you can listen on the base speaker while the caller leaves a message.
- To speak to the caller, simply answer the call: the answering system stops automatically when you pick up the call.
- To mute the speaker and stop screening this call, press [▶/■]. The caller can continue the message, but you will not be able to hear it. This mutes the speaker for this call only; it will play as soon as the next call comes in. To cancel muting and listen to the speaker for the rest of this call, press [vol/select/▲] or [vol/select/▼].
- If you mute the ringer for a call, you cannot screen that call.

7-6. Recording a Call

Every state has different regulations governing the recording of conversations over the telephone. Check your local, state and federal laws before using this feature to make sure any recordings comply with local laws or guidelines.

- You can record up to ten minutes of ongoing call.
- Calls must last at least two seconds.
- Recorded calls are handled just like regular answering system messages.
- To start recording an ongoing call, press and hold [memo] on the base. The message counter flashes - -, and the base sounds a beep that can be heard by *both* parties.
- To stop recording, press [▶/■] or [memo]. You hear a confirmation tone.
- If the memory is full, the message counter shows $F L$, and the base stops recording.
- If another call comes in while you are recording a conversation, you can still press [TALK/flash] to switch to the new caller. The base puts the original call on hold and begins recording the new call.

7-7. Recording a Voice Memo

You can record a voice memo directly onto the base; this memo is handled like a regular answering system message. The memo must be at least two seconds long and no longer than four minutes.

- 1) With the phone in standby, press and hold [memo] on the base; the message counter flashes - -.
- 2) Start recording your message.
- 3) To stop recording, press [memo] again. The base sounds a confirmation tone and returns to standby.

Note: If the memory is full, the message counter shows $F L$, and the base stops recording.

8) Using the Answering System While You're Away from Home

When you are away from home, you can operate your answering system with any touch-tone telephone.

8-1. Programming a Security Code

You must set a two-digit security code in order to access your answering system from another telephone.

- 1) Press **[menu/clock]** on the base to open the answering system menu. The voice prompt announces the first menu item.
- 2) Press **[menu/clock]** repeatedly until you hear the voice prompt announce "Security code".
- 3) Use **[vol/select/▲]** or **[vol/select/▼]** to change the security code.
 - Choose a number between **01** and **99**.
 - Press and hold **[vol/select/▲]** or **[vol/select/▼]** to scroll through the numbers quickly.
 - As you press **[vol/select/▲]** or **[vol/select/▼]**, the voice prompt announces current number, and it appears in the message counter.
- 4) When you reach the number you want, press **[set]** to set the new code.

Note: Don't forget your security code!

8-2. Dialing in To Your Answering System

- 1) Call your telephone number and wait for the answering system to answer.

Note: If you turned on the Toll Saver feature, the answering system will answer after 2 rings if you have new messages and after 4 rings if you don't. If you call in to check for new messages, you can just hang up after the third ring.

- 2) While the greeting is playing, press **[0]** and **immediately** enter your security code.
- 3) The voice prompt announces the current time and the number of messages stored in memory, followed by short help prompts. After the voice prompts, the answering system sounds intermittent beeps to remind you that it is waiting for a command.

Note: If you don't enter a command within fifteen seconds, the answering system automatically hangs up and returns to standby.

- 4) Enter a remote command from the following chart (you can enter during the voice prompts):

| To | Press | To | Press |
|------------------------|----------------------------|---|----------------------------|
| Play Incoming messages | [0] then [2] | Turn the answering system on | [0] then [6] |
| Stop Operation | [0] then [5] | Turn the answering system off | [0] then [9] |
| Repeat a message | [0] then [1] | Hear the voice prompts again | [1] then [0] |
| Skip a message | [0] then [3] | Start/stop recording a voice memo* | [0] then [7] |
| Delete a message | [0] then [4] | Start/stop recording a personal greeting* | [0] then [8] |

* Enter the command again to stop the recording.

- 5) When you are finished, just hang up. The answering system automatically returns to standby.

Note: For your convenience, a removable remote operation card is printed at the back of this manual.

8-3. Turn on the Answering System Remotely

If you forgot to turn on your answering system, you can turn it on remotely from any touch-tone telephone.

- 1) Call your telephone number, and let it ring ten times.
- 2) After ten rings, the answering system answers the phone, but it only sounds the "waiting for command" beeps.
- 3) Press **[0]** and then enter your security code. You can now use the remote commands to control your answering system.
- 4) To have the answering system remain on after you hang up, press **[0]** then **[6]**. The answering system plays the greeting and sounds a confirmation tone.
- 5) Hang up the phone. The answering system will stay on and answer any subsequent calls.

9) Mounting the Base on a Wall

You can mount the phone on any standard telephone jack wall plate.

- 1) Turn the base upside down to reach the desk stand.

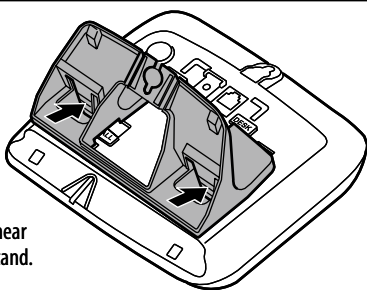

- 2) On the stand, press in on the two latches near the bottom of the base, and remove the stand.

- 3) Rotate the stand 180 degrees, and insert the two tabs into the notches marked WALL.

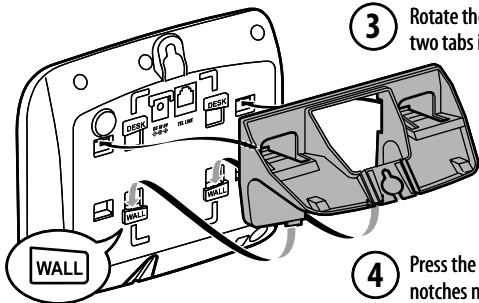

- 4) Press the latches in and slip them into the notches near the top of the base.

- 5) Connect the AC adapter to the **DC IN 9V** jack, and route the cord through the molded wiring channel on right side as shown.

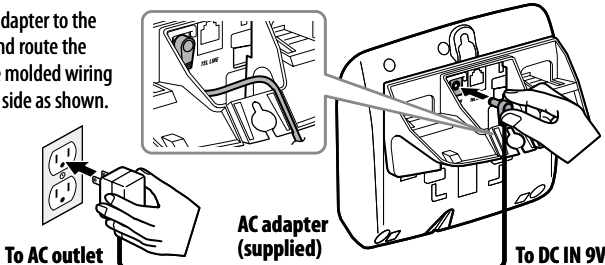

To AC outlet

AC adapter (supplied)

To DC IN 9V

6 Connect the telephone cord to the **TEL LINE** jack and the telephone wall jack.

7 Tuck the extra telephone cord into the hole in the stand, and align the mounting slots on the base with the mounting posts on the wall jack.

8 Push in and down until the phone is firmly seated.

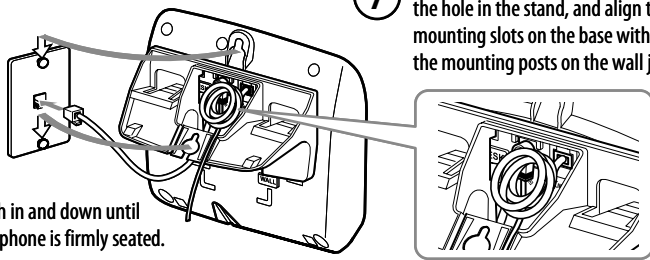

Note: To mount the phone directly on the wall, insert two 1 3/8 inch, #10 screws (not supplied) into the wall using anchors suitable for the wall material. Place the screws 3 15/16 inches apart, and allow 1/8 inch free space between the wall and screw heads.

10) Troubleshooting and Maintenance

10-1. Solving Common Issues

If your phone is not performing to your expectations, please try these simple steps first. If these steps do not solve your problem, please call our Customer Hotline. See back cover page for contact information.

| When you have this problem... | Try... |
|--|---|
| The charge/in use LED won't turn on when the handset is placed in the cradle. | <ul style="list-style-type: none"> • Checking the AC adapter connection. • Re-seating the handset in the cradle. • Cleaning the charging contacts on the handset (See section 10-8). |
| The audio sounds weak and/or scratchy. | <ul style="list-style-type: none"> • Moving the handset closer to the base. • Moving the handset and/or base away from metal objects or appliances and try again. • Changing the channel by pressing [select/channel] during a call. This can help eliminate background noise. |
| The phone can't make or receive calls. | <ul style="list-style-type: none"> • Checking the telephone cord connection. • Disconnecting the AC adapter. Wait a few minutes, then reconnect it. • Asking your telephone company if they use pulse dialing (See section 1-4). |
| The handset can make calls, but it doesn't ring. | <ul style="list-style-type: none"> • Making sure the ringer isn't turned off (see section 3-5). |
| The handset's display doesn't show anything. | <ul style="list-style-type: none"> • Charging the battery for 15-20 hours. • Checking the battery pack connection. |
| There's a lot of static during calls. | <ul style="list-style-type: none"> • Changing the channel by pressing [select/channel] during a call to help eliminate background noise. • Keeping the handset away from microwave ovens, computers, remote control toys, wireless microphones, alarm systems, intercoms, room monitors, fluorescent lights, and electrical appliances. • Moving the base to a better location (see section 1-1). |
| The handset won't display any Caller ID information. | <ul style="list-style-type: none"> • Letting incoming calls ring at least twice before answering. • Checking to see if the call was placed through a switchboard. • Checking with your telephone service provider to make sure your Caller ID service is active (See section 5). |
| The handset is not working. | <ul style="list-style-type: none"> • Checking the battery pack connection. • Charging the battery for 15-20 hours. • Changing the handset-to-base code (See section 10-3). |
| The handset says "Unavailable". | <ul style="list-style-type: none"> • Moving the handset closer to the base. • Making sure the base is plugged in. • Changing the handset-to-base code (See section 10-3). |
| The answering system does not work. | <ul style="list-style-type: none"> • Making sure the AC adapter is plugged into wall outlet. • Making sure the answering system is turned on (See section 7-3). |
| The answering system does not record any messages. | <ul style="list-style-type: none"> • Setting the record time to either the one minute or four minute option (See section 7-1). • The memory may be full. Delete some or all of the saved messages (See section 7-4). |
| Messages are incomplete. | <ul style="list-style-type: none"> • The incoming messages may be too long. Remind callers to leave a brief message. • The memory may be full. Delete some or all of the saved messages (See section 7-4). |
| After a power failure, my outgoing message is gone. | <ul style="list-style-type: none"> • Record your personal outgoing message again. The default message should remain (See section 7-2). |
| I can't hear the base speaker during call screening or message playback. | <ul style="list-style-type: none"> • Changing the base speaker volume (See section 4-4). |
| I can't access my answering system from another touch-tone phone. | <ul style="list-style-type: none"> • Making sure you're using the correct security code (See section 8-1). • Using another phone to access your messages (in case this telephone doesn't follow the standards for touch-tone phones). |

10-2. Re-registering the Handset

When you first put your handset into the base, it is registered so it can communicate with the base. There may be some times when you have to re-register your handset to the base:

- When you want to change the handset-to-base code.
- When there is a power failure that lasts more than one hour.
- If the handset's battery is completely discharged. (The handset must be recharged for 15 - 20 hours before re-registering to the base.)
- Any time you experience difficulty connecting to the base to make or receive calls.

To re-register the handset:

- 1) Pick up the handset from the base. Press and hold **[find hs]** on the base.
- 2) While holding **[find hs]**, place the handset in the base. The **charge/in use** LED on the base begins to flash, indicating the base is registering the handset. Wait for at least five seconds.
- 3) Pick up the handset from the base and press **[TALK/flash]**. If the display shows TALK, the handset is registered. If not, place the handset in the base to try again.
- 4) Press **[END]**.

10-3. Changing the Handset-to-base Code

The handset-to-base code prevents other cordless devices from accidentally connecting to your base. If the battery pack is completely discharged or removed, the handset-to-base code will be lost. If this happens, a new code is set automatically the next time the handset is charged in the base. In the rare situation that you suspect another cordless telephone is using the same code, you can change the code.

To change the handset-to-base code, re-register the handset to the base following the instructions in section 10-2 on Re-registering the Handset above.

10-4. Traveling Out of Range

During a call, as you begin to move your handset too far from your base noise increases. If you pass the range limits of the base, your call will terminate within one minute.

10-5. Liquid Damage

Moisture and liquid can damage your cordless phone.

- If the handset or base is exposed to moisture or liquid, but only the exterior plastic housing is affected, wipe off the liquid, and use as normal.
- If moisture or liquid has entered the plastic housing (i.e. liquid can be heard in the phone or liquid has entered the handset battery compartment or vent openings on the base), follow the steps below:

| Handset | Base |
|--|---|
| 1) Remove the battery cover and leave it off for ventilation. | 1) Disconnect the AC adapter from the base, cutting off electrical power. |
| 2) Disconnect the battery pack. Leave the battery cover off and the battery pack disconnected for at least three days. | 2) Disconnect the telephone cord from the base. |
| 3) Once the handset is completely dry, reconnect the battery pack and the battery cover. | 3) Let dry for at least three days. |
| 4) Recharge the handset's battery pack for 15 to 20 hours before using. | |

IMPORTANT:

You must unplug the telephone line while recharging the battery pack to avoid charge interruption.

CAUTION!

DO NOT use a microwave oven to speed up the drying process. This will cause permanent damage to the handset, base and the microwave oven. After following these steps, if your cordless telephone does not work, please call our Customer Service Hotline. See back cover page for contact information.

10-6. Specifications

The phone complies with FCC Parts 15 and 68.

| | | |
|------------------------------|---|--------------|
| Operating temperature | 0°C to +50°C (+32°F to +122°F) | |
| AC Adapter | Part number | PS-0003 |
| | Input Voltage | 120V AC 60Hz |
| | Output Voltage | 9V DC 350mA |
| Battery | Part number | BT-905 |
| | Capacity | 600mAh, 3.6V |
| Frequency | 921.103102 – 923.787761 MHz 5,856.533347 – 5,863.692437MHz | |

Note: To avoid damage to the phone, use only Uniden PS-0003 and BT-905 with your phone.

Specifications, features, and availability of optional accessories are all subject to change without prior notice.

10-7. Power Failure Operation

During the period that the power is off, you will not be able to make or receive calls with the telephone.

10-8. Battery Information

Average battery life

With average use, your handset battery provides approximately six hours of talk time and approximately fourteen days of standby time. You can achieve optimum battery life and performance by returning the handset to the cradle after each use. When your handset is left off of the cradle, the battery will gradually discharge even if the handset is not being used. The actual talk time duration will be reduced in proportion to the amount of time the handset is off the cradle.

Low battery alert

When the battery pack is very low and needs to be charged, the phone is programmed to eliminate functions in order to save power. If the phone is not in use, LOW BATTERY CHARGE HANDSET appears on the LCD, and none of the keys will operate. During a call, the handset beeps, and the LCD flashes LOW BATTERY. Complete your conversation as quickly as possible and return the handset to the cradle for charging.

Note: Information stored in the phone's memory will be retained for thirty minutes after the battery pack is removed. This includes all setup information, last number dialed, speed dial memory, and the CID list.

Low Battery
Charge Handset

Battery replacement and handling

When the operating time becomes short even after a battery is recharged, please replace the battery. With normal usage, your battery should last about one year. To order replacement batteries, please contact Uniden's Parts Department. The contact information is listed on the back cover page.

Warning:

To avoid the risk of personal injury or property damage from fire or electrical shock, only use the Uniden battery model and Uniden adapter model specifically designated for this product.

Caution:

- Use only the specified Uniden battery pack (BT-905).
- Do not remove the battery from the handset to charge it.
- Never throw the battery into a fire, disassemble it, or heat it.
- Do not remove or damage the battery casing.

Cleaning the charging contacts

To maintain a good charge, clean the charging contacts on the handset once a month. Dampen a cloth with plain water. Gently rub the damp cloth over the charging contacts until all visible dirt is removed. Dry the contacts thoroughly before returning the handset to the cradle.

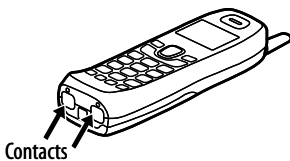
**Caution:**

Do not use paint thinner, alcohol, or other chemical products. Doing so may discolor the surface of the telephone and damage the finish.

11) Legal and Warranty Information

11-1. Precautions!

Before you read anything else, please note the following:

Warning!

Uniden America Corporation DOES NOT represent this unit to be waterproof. To reduce the risk of fire, electrical shock, or damage to the unit, DO NOT expose this unit to rain or moisture.

11-2. Rechargeable Nickel-Cadmium Battery Information

This equipment contains a rechargeable nickel-cadmium battery.

- Cadmium is a chemical known to the State of California to cause cancer.
- The rechargeable nickel-cadmium battery contained in this equipment may explode if disposed of in a fire.
- Do not short-circuit the battery.
- Do not charge the rechargeable nickel-cadmium battery used in this equipment in any charger other than the one designed to charge this battery as specified in the owner's manual. Using another charger may damage the battery or cause the battery to explode.
- Rechargeable Nickel-Cadmium Batteries Must Be Recycled or Disposed of Properly
- As part of our commitment to protecting our environment and conserving natural resources, Uniden voluntarily participates in an RBRC® industry program to collect and recycle used Ni-Cd batteries within the United States. Please call 1-800-8-BATTERY for information on Ni-Cd battery recycling in your area. (RBRC® is a registered trademark of the Rechargeable Battery Recycling Corporation.)



11-3. Lead Content Information

Warning!

The cords on this product and/or accessories contain lead, a chemical known to the State of California to cause birth defects or other reproductive harm. Wash hands after handling.

Uniden works to reduce lead content in our PVC coated cords in our products and accessories.

11-4. Important Safety Instructions

When using your telephone equipment, basic safety precautions should always be followed to reduce the risk of fire, electric shock and injury to persons, including the following:

1. Do not use this product near water, for example, near a bath tub, wash bowl, kitchen sink or laundry tub, in a wet basement or near a swimming pool.
2. Avoid using a telephone (other than a cordless type) during an electrical storm. There may be a remote risk of electric shock from lightning.
3. Do not use the telephone to report a gas leak in the vicinity of the leak.
4. Use only the power cord and batteries indicated in this manual. Do not dispose of batteries in a fire. They may explode. Check with local authorities for possible battery disposal instructions.
5. Do not disassemble any component of this product.

SAVE THESE INSTRUCTIONS**CAUTION!**

Risk of explosion if battery is replaced by an incorrect type. Dispose of used batteries according to the instructions. Do not open or mutilate the battery, and disconnect the battery before shipping this product.

11-5. The FCC Wants You To Know

This equipment complies with Part 68 of the FCC rules and the requirements adopted by the ACTA.

On the bottom of this equipment is a label that contains, among other information, a product identifier in the format US: AAAEQ##TXXXX. If requested, this number must be provided to the telephone company.

An applicable Universal Service Order Codes (USOC) certification for the jacks used in this equipment is provided (i.e., RJ11C) in the packaging with each piece of approved terminal equipment. A plug and jack used to connect this equipment to the premises wiring and telephone network must comply with the applicable FCC Part 68 rules and requirements adopted by the ACTA.

A compliant telephone cord and modular plug is provided with this product. It is designed to be connected to a compatible modular jack that is also compliant. See installation instructions for details.

The REN is used to determine the number of devices that may be connected to a telephone line. Excessive RENs on a telephone line may result in the devices not ringing in response to an incoming call. In most but not all areas, the sum of RENs should not exceed five (5.0). To be certain of the number of devices that may be connected to a line, as determined by the total RENs, contact the telephone provider. For products approved after July 23, 2001, the REN for this product is part of the product identifier that has the format US:AAAEQ##TXXXX. The digits represented by ## are the REN without a decimal point (e.g., 03 is a REN of 0.3). For earlier products, the REN is separately shown on the label.

If this equipment causes harm to the telephone network, the telephone company will notify you in advance that temporary discontinuance of service may be required. But if advance notice isn't practical, the telephone company will notify the customer as soon as possible. Also, you will be advised of your right to file a complaint with the FCC if you believe it is necessary. The telephone company may make changes in its facilities, equipment, operations or procedures that could affect the operation of the equipment. If this happens the telephone company will provide advance notice in order for you to make necessary modifications to maintain uninterrupted service. Please follow instructions for repairing, if any (e.g. battery replacement section); otherwise do not substitute or repair any parts of the device except as specified in this manual. Connection to party line service is subject to state tariffs. Contact the state public utility commission, public service commission or corporation commission for information. This equipment is hearing aid compatible.

Should you experience trouble with this equipment, please contact Uniden customer service at 800-297-1023. If the equipment is causing harm to the telephone network, the telephone company may request that you disconnect the equipment until the problem is resolved.

NOTICE: According to telephone company reports, AC electrical surges, typically resulting from lightning strikes, are very destructive to telephone equipment connected to AC power sources. To minimize damage from these types of surges, a surge arrester is recommended.

Changes or modifications to this product not expressly approved by Uniden, or operation of this product in any way other than as detailed by the owner's manual, could void your authority to operate this product.

This device complies with part 15 of the FCC rules. Operation is subject to the following two conditions: (1) This device may not cause harmful interference, and (2) This device must accept any interference received, including interference that may cause undesired operation. Privacy of communications may not be ensured when using this phone.

Cordless telephone privacy

Cordless telephones are radio devices. Communications between the handset and base of your cordless telephone are accomplished by means of radio waves which are broadcast over the open airways. Because of the inherent physical properties of radio waves, your communications can be received by radio receiving devices other than your own cordless telephone unit. Consequently, any communications using your cordless telephone may not be private.

11-6. I.C. Notice

Terminal equipment

NOTICE: This equipment meets the applicable Industry Canada Terminal Equipment Technical Specifications. This is confirmed by the registration number. The abbreviation, IC, before the registration number signifies that registration was performed based on a Declaration of Conformity indicating that Industry Canada technical specifications were met. It does not imply that Industry Canada approved the equipment.

NOTICE: The Ringer Equivalence Number (REN) for this terminal equipment is marked on the equipment itself. The REN assigned to each terminal equipment provides an indication of the maximum number of terminals allowed to be connected to a telephone interface. The termination on an interface may consist of any combination of devices subject only to the requirement that the sum of the Ringer Equivalence Numbers of all the devices does not exceed five.

Radio equipment

The term "IC:" before the radio certification number only signifies that Industry Canada technical specifications were met. Operation is subject to the following two conditions: (1) this device may not cause interference, and (2) this device must accept any interference, including interference that may cause undesired operation of the device. "Privacy of communications may not be ensured when using this telephone".

11-7. One Year Limited Warranty

Important: Evidence of original purchase is required for warranty service. WARRANTOR: UNIDEN AMERICA CORPORATION ("Uniden") ELEMENTS OF WARRANTY: Uniden warrants, for one year, to the original retail owner, this Uniden Product to be free from defects in materials and craftsmanship with only the limitations or exclusions set out below.

WARRANTY DURATION: This warranty to the original user shall terminate and be of no further effect 12 months after the date of original retail sale. The warranty is invalid if the Product is (A) damaged or not maintained as reasonable or necessary, (B) modified, altered, or used as part of any conversion kits, subassemblies, or any configurations not sold by Uniden, (C) improperly installed, (D) serviced or repaired by someone other than an authorized Uniden service center for a defect or malfunction covered by this warranty, (E) used in any conjunction with equipment or parts or as part of any system not manufactured by Uniden, or (F) installed or programmed by anyone other than as detailed by the owner's manual for this product.

STATEMENT OF REMEDY: In the event that the product does not conform to this warranty at any time while this warranty is in effect, warrantor will either, at its option, repair or replace the defective unit and return it to you without charge for parts, service, or any other cost (except shipping and handling) incurred by warrantor or its representatives in connection with the performance of this warranty. Warrantor, at its option, may replace the unit with a new or refurbished unit. THE LIMITED WARRANTY SET FORTH ABOVE IS THE SOLE AND

ENTIRE WARRANTY PERTAINING TO THE PRODUCT AND IS IN LIEU OF AND EXCLUDES ALL OTHER WARRANTIES OF ANY NATURE WHATSOEVER, WHETHER EXPRESS, IMPLIED OR ARISING BY OPERATION OF LAW, INCLUDING, BUT NOT LIMITED TO ANY IMPLIED WARRANTIES OF MERCHANTABILITY OR FITNESS FOR A PARTICULAR PURPOSE. THIS WARRANTY DOES NOT COVER OR PROVIDE FOR THE REIMBURSEMENT OR PAYMENT OF INCIDENTAL OR CONSEQUENTIAL DAMAGES. Some states do not allow this exclusion or limitation of incidental or consequential damages so the above limitation or exclusion may not apply to you.

LEGAL REMEDIES: This warranty gives you specific legal rights, and you may also have other rights which vary from state to state. This warranty is void outside the United States of America and Canada. PROCEDURE FOR OBTAINING PERFORMANCE OF WARRANTY: If, after following the instructions in the owner's manual you are certain that the Product is defective, pack the Product carefully (preferably in its original packaging). Disconnect the battery from the Product and separately secure the battery in its own separate packaging within the shipping carton. The Product should include all parts and accessories originally packaged with the Product. Include evidence of original purchase and a note describing the defect that has caused you to return it. The Product should be shipped freight prepaid, by traceable means, to warrantor at:

Uniden America Service
4700 Amon Carter Blvd.
Fort Worth, TX 76155

May be covered under one or more of the following U.S. patents:

4,797,916 5,426,690 5,491,745 5,493,605 5,533,010 5,574,727 5,581,598 5,650,790 5,660,269 5,663,981 5,671,248
5,717,312 5,732,355 5,754,407 5,758,289 5,768,345 5,787,356 5,794,152 5,801,466 5,825,161 5,864,619 5,893,034
5,912,968 5,915,227 5,929,598 5,930,720 5,960,358 5,987,330 6,044,281 6,070,082 6,0760,52 6,125,277 6,253,088
6,314,278 6,321,068 6,418,209 6,618,015 6,671,315 6,714,630 6,782,098 6,788,920 6,788,953 6,839,550 6,889,184
6,901,271 6,907,094 6,914,940 6,940,867 6,953,118 7,023,176 7,030,819 7,146,160 7,203,307 7,206,403

Other patents pending.

Uniden® is a registered trademark of Uniden America Corporation.



As an Energy Star® Partner, Uniden has determined that this product or product models meets the Energy Star® guidelines for energy efficiency. Energy Star® is a U.S. registered mark.

Remote Operation Card

CUT

| Task | Key | Task | Key |
|------------------------|-----|------------------------------|-----|
| Repeat a Message | 0 1 | Answering System On | 0 6 |
| Play Incoming Messages | 0 2 | Memo Record/Stop | 0 7 |
| | | Greeting Message Record/Stop | 0 8 |
| Skip a Message | 0 3 | Answering System Off | 0 9 |
| Delete a Message | 0 4 | Voice Prompts | 1 0 |
| Stop Operation | 0 5 | | |