

Digital Copier

Operating Instructions (For Copier)

Model No.

DP-150FX

Options

DA-DS150

DA-SM16B

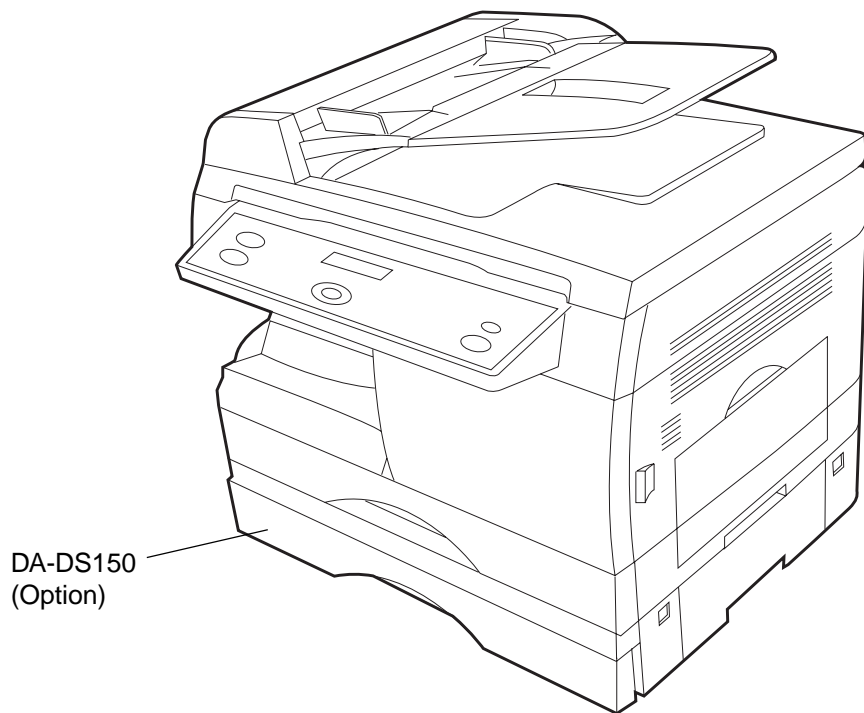

Before operating this copier, please read these instructions completely and keep these operating instructions for future reference.

Operation Chart

Common Features

Full Size Copying 100%

Automatic Document Feeder

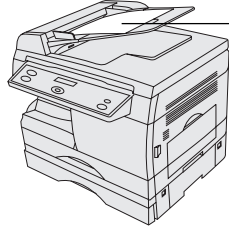

Turn the Power Switch On (See page 9)
Load the paper (See page 23)

Control Panel



1

Place the Original

- Face-Up
- Up to 30 originals (20 lbs.), size: Invoice - Legal

2

Press the Copy Key

(3)

Select paper tray

4

Number of Copies (Up to 99)

5

Press Start

How to copy without using ADF (Automatic Document Feeder).

Position of the original

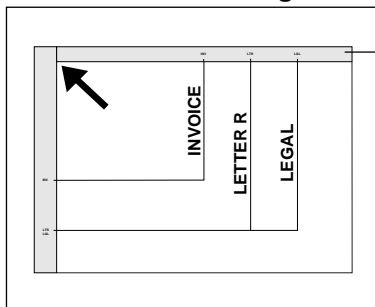

Original Guide

Place original against guide.

- Face DOWN on platen.
- If the original is not positioned properly, a portion of the original may not be copied.

When manually selecting exposure control

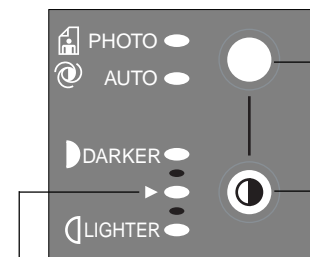

Normal Position

- The copier has auto exposure control and adjustments are rarely required.

Select Photo to copy photos and halftones.
Select Auto to copy with Auto exposure control.

Select Dark to copy light image originals.
Select Light to copy colored background originals.

NOTE

Inappropriate originals for use with the ADF

- Paper with a smooth surface such as glossy and coated papers
- Transparencies
- Paste-ups
- Originals with a lead edge that is "creased", "folded", "punched" or "glued"
- Pressure sensitive or carbon backed papers
- Paper with excessive curl
- Stapled originals
- Originals with oil on them
- Remove stacked copies from the exit tray every 200 sheets.

Overview

Useful for office, more than 4 functions

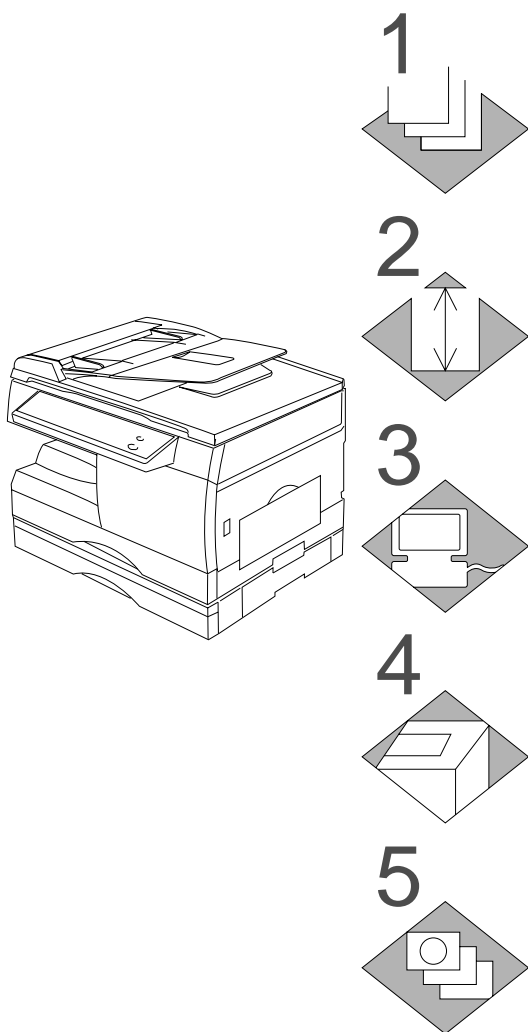

Copier

- Can copy up to Legal size.
- Available to copy text/photos/halftone originals.

Facsimile

- Plain paper Super G3 compatible Fax.
- Can be used as a regular telephone with optional handset.

Printer

- Digital printer controller standard, printer resolution 300 or 600 dpi.

Scanner

- Black & White original scanner standard, scan resolution at up to 400 dpi.

Application Software

- Document Manager
- Document Viewer
- Document Scanner
- Utilities (Status Monitor, Phone Book Editor, Device Configuration Editor)

DP-150FX Operating Instructions (Manual Overview)

This copier includes 3 operating instruction manuals, please use the correct manual when operator intervention is necessary.

<Copier>

Use the information provided in this manual whenever a copier function requires intervention. For example: how to make copies, add paper, replace the toner cartridge, etc..

<Facsimile>

Use the information provided in the DP-150FX Facsimile Operating Instructions manual whenever a fax function requires intervention. For example: how to send/receive a fax, or when a trouble message appears, etc..

<Printer>

&

<Other Advanced Functions>

Use the information provided on the enclosed CD for an explanation of how to use as a Printer, Scanner, Phone Book Editor, Device Settings, Status Monitor, and/or Document Management System.

Energy Star



The DP-150FX copier complies with Tier 2 of the Environmental Protection Agency's Energy Star Program. This voluntary program specifies certain energy consumption and usage standards for copiers. These copiers will automatically "power down" after a specified period of non-use. The use of these Energy Star compliant copiers will reduce energy consumption and ultimately benefit the environment.

The default functions can be adjusted depending on your office requirements. Please see your authorized Panasonic copier dealer for more details.

Table of Contents

Before Operation

- Overview 3
- Precautions 6
- Components
 - External/Internal 9
 - Control Panel 10
- Mode Functions 12
- Features 13

Making Copies

- Common Features
 - Full Size Copying 2
 - Reduction or Enlargement Copying 14
 - Zoom Copying 15
- Creative Features
 - Digital Skyshot Copy 16
 - 2 Sided Copy 17
 - 2 in 1 Copy 18
 - 2 in 1 Copy (2 Sided mode) 19
 - Sorting 20
 - Using the Sheet Bypass 21

Option

- Option 22

Maintenance

- Handling
 - Adding Paper 23
 - Changing Paper Size 24
 - Changing Toner Cartridge 25
 - Changing Drum Unit 26
 - Removing a Paper Misfeed (Main Unit) 27
 - Removing a Paper Misfeed (ADF) 29
 - Removing an original Misfeed (Automatic Duplex Unit) 30
 - Removing a Paper Misfeed (2nd Paper Feed Module) 31
- Checking
 - Troubleshooting 32

Others

- Specifications 35
- Consumable List 36

Precautions

For your safety

■ Laser Safety

Caution

This product utilizes a laser.
Use of controls or adjustments or performance of procedures other than those specified herein may result in hazardous radiation exposure.

■ Caution Labels

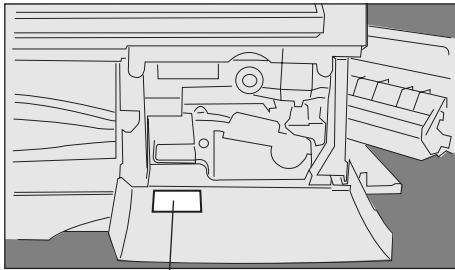

DANGER-Invisible laser radiation when open and interlock defeated.
AVOID DIRECT EXPOSURE TO BEAM.  FFP1E2479

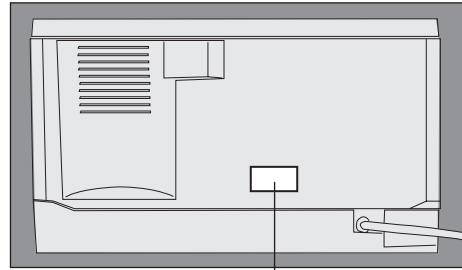

Product complies with DHHS Rules 21 CFR Subchapter J in effect at date of manufacture.
Matsushita Graphic Communication Systems, Inc.
Utsunomiya, Tochigi, Japan
MANUFACTURED:

Label when manufactured in Japan.

Product complies with DHHS Rules 21 CFR Subchapter J in effect at date of manufacture.
Matsushita Business Machine Corporation of the Philippines
Taytay, Rizal, Philippines
MANUFACTURED:

Label when manufactured in Philippines.

Handling

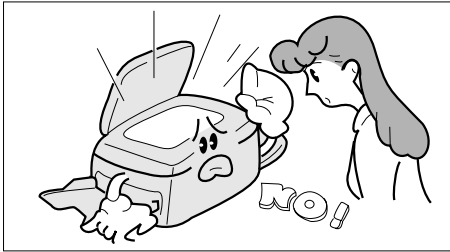

- Do not look directly at exposure lamp when copying.
- Do not turn the power switch off or open the front panel during copying. (See page 9)
- Do not drop paper clips or other metal objects into the copier.

Toner and Paper

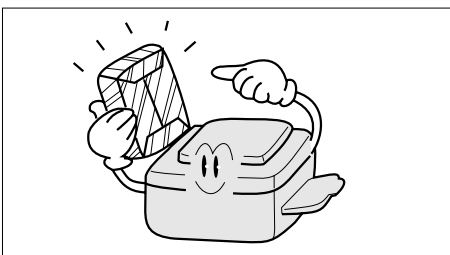

- Store toner cartridge and paper in cool areas with low humidity.
- High quality paper of 16 lbs. - 24 lbs. (15 – 34 lbs. via sheet bypass) may be used.
- For optimum performance, it is recommended that only Panasonic Brand supplies are used in the copier.

Ventilation

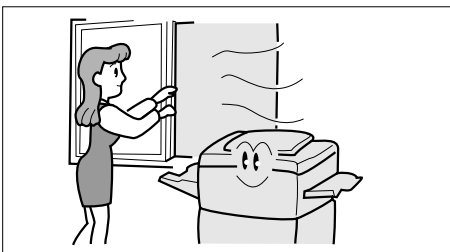

- The copier should be installed in a well-ventilated area to minimize the ozone density in the air.

Precautions

Installation

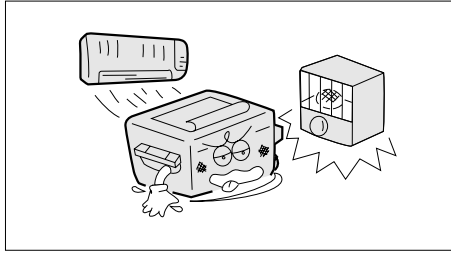

- The copier should not be installed in areas with the following conditions:
 - Extremely high or low temperature and humidity.
Proper ambient conditions
Temperature: 50°F – 90°F
Relative humidity: 30% – 80%
 - Where temperature and humidity can change rapidly, causing condensation.
 - Direct exposure to sunlight.
 - Directly in air conditioning flow.
 - In areas of high dust concentration.
 - In areas of poor ventilation.
 - In areas with chemical fume concentration.
 - In areas with extreme vibration.
 - With unstable or uneven conditions (floors, etc.).

- The power consumption is 1.0 kW.

A properly wired (with ground), dedicated, 15A, 120V AC outlet is required. Do not use an extension cord.

The main plug on this equipment must be used to disconnect main power. Please ensure that the socket outlet is installed near the equipment and shall be easily accessible.

For U.S.A.

This equipment has been tested and found to comply with the limits for a Class A digital device, pursuant to part 15 of the FCC Rules. These limits are designed to provide reasonable protection against harmful interference when the equipment is operated in a commercial environment. This equipment generates, uses, and can radiate radio frequency energy and, if not installed and used in accordance with the instruction manual, may cause harmful interference to radio communications. Operation of this equipment in a residential area is likely to cause harmful interference in which case the user will be required to correct the interference at his/her own expense.

Any unauthorized changes or modifications to this equipment would void the users authority to operate this device.

Components

External/Internal

External

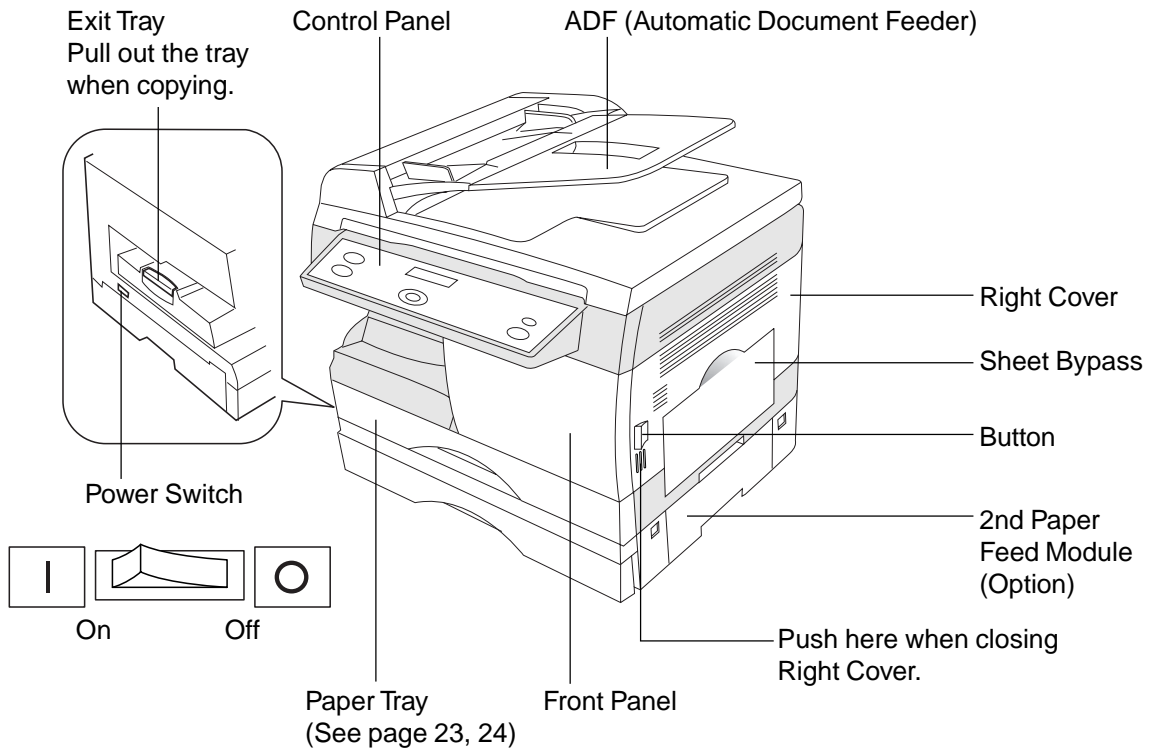

Internal

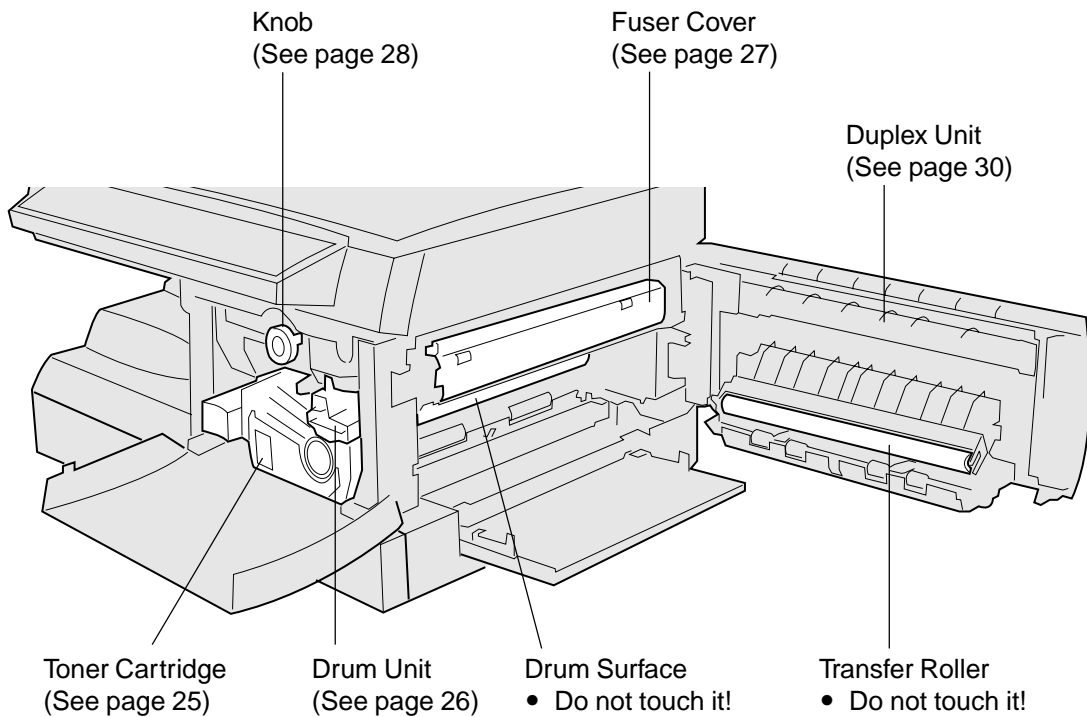

Components

Control Panel

- **Function keys for making copies.**
(Function keys for fax, please see fax instruction.)

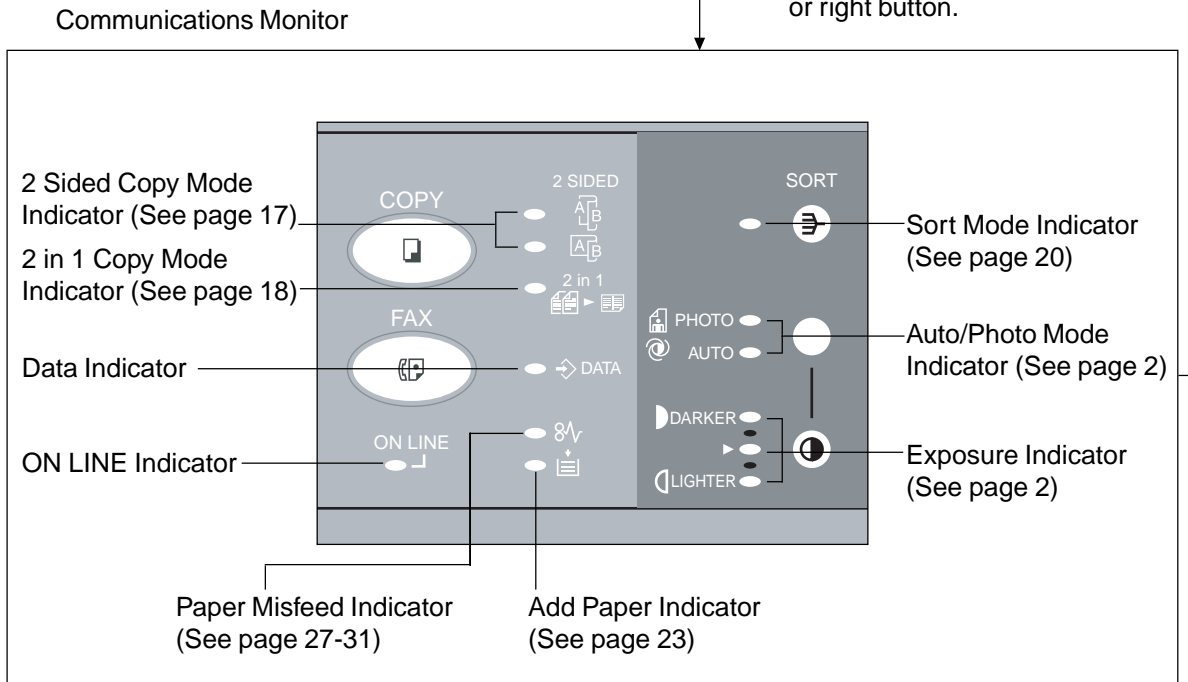
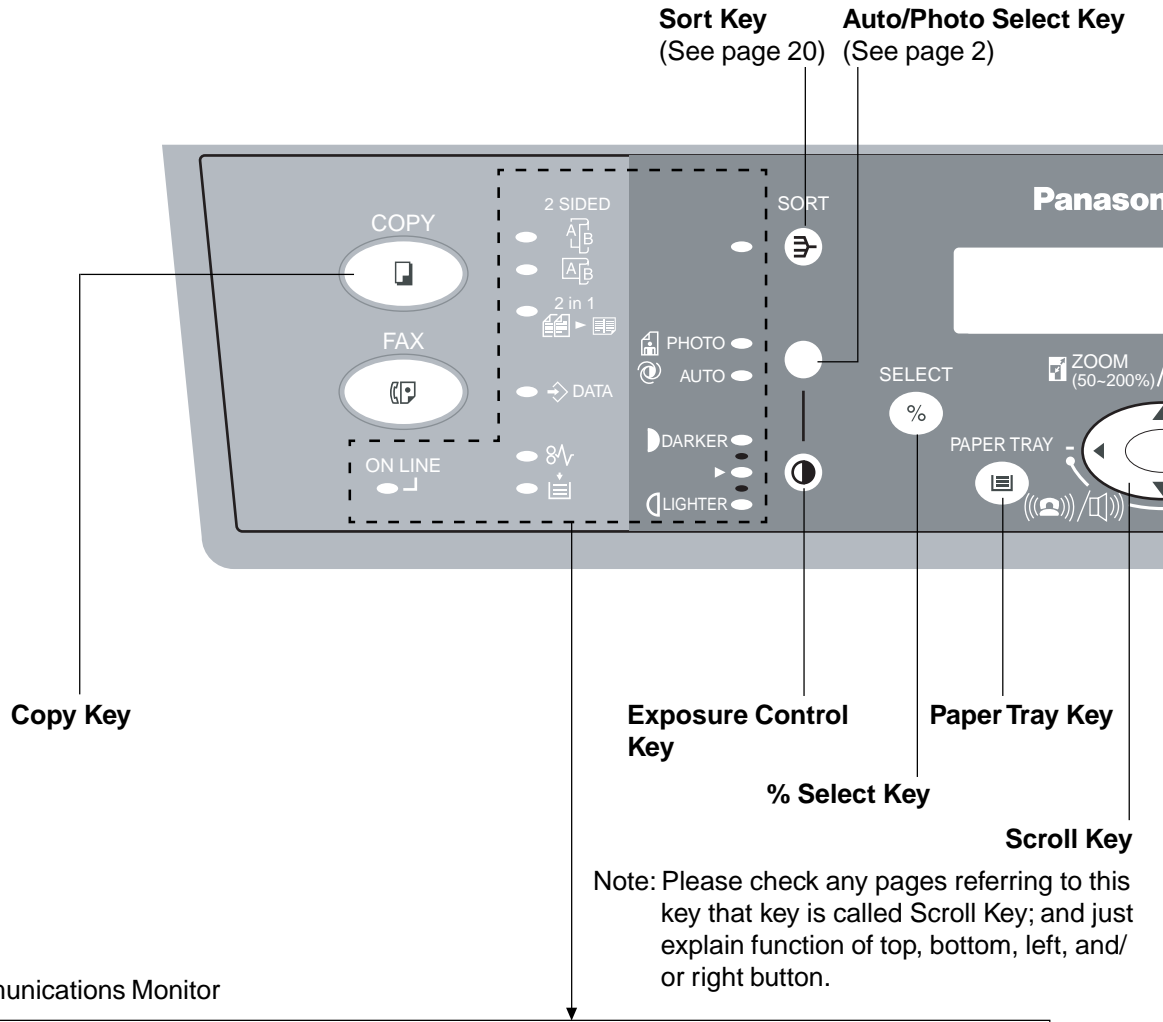

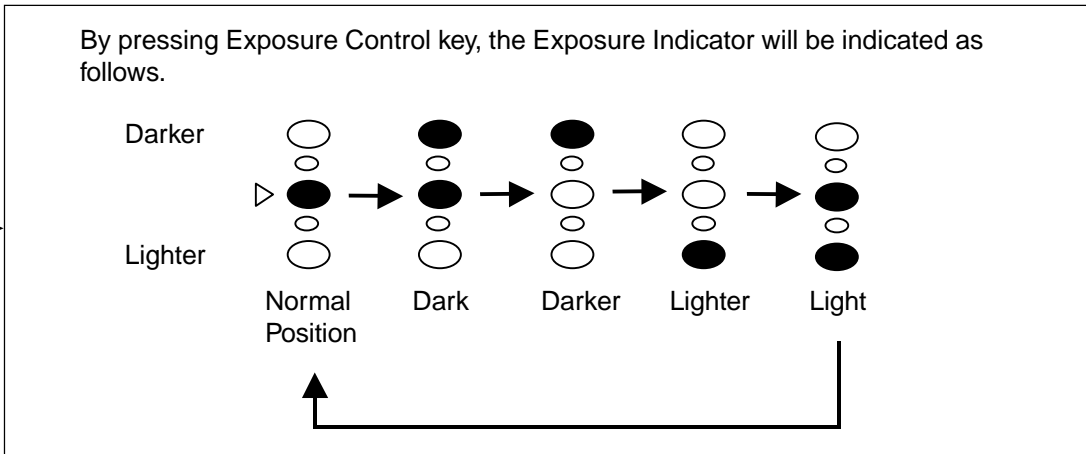
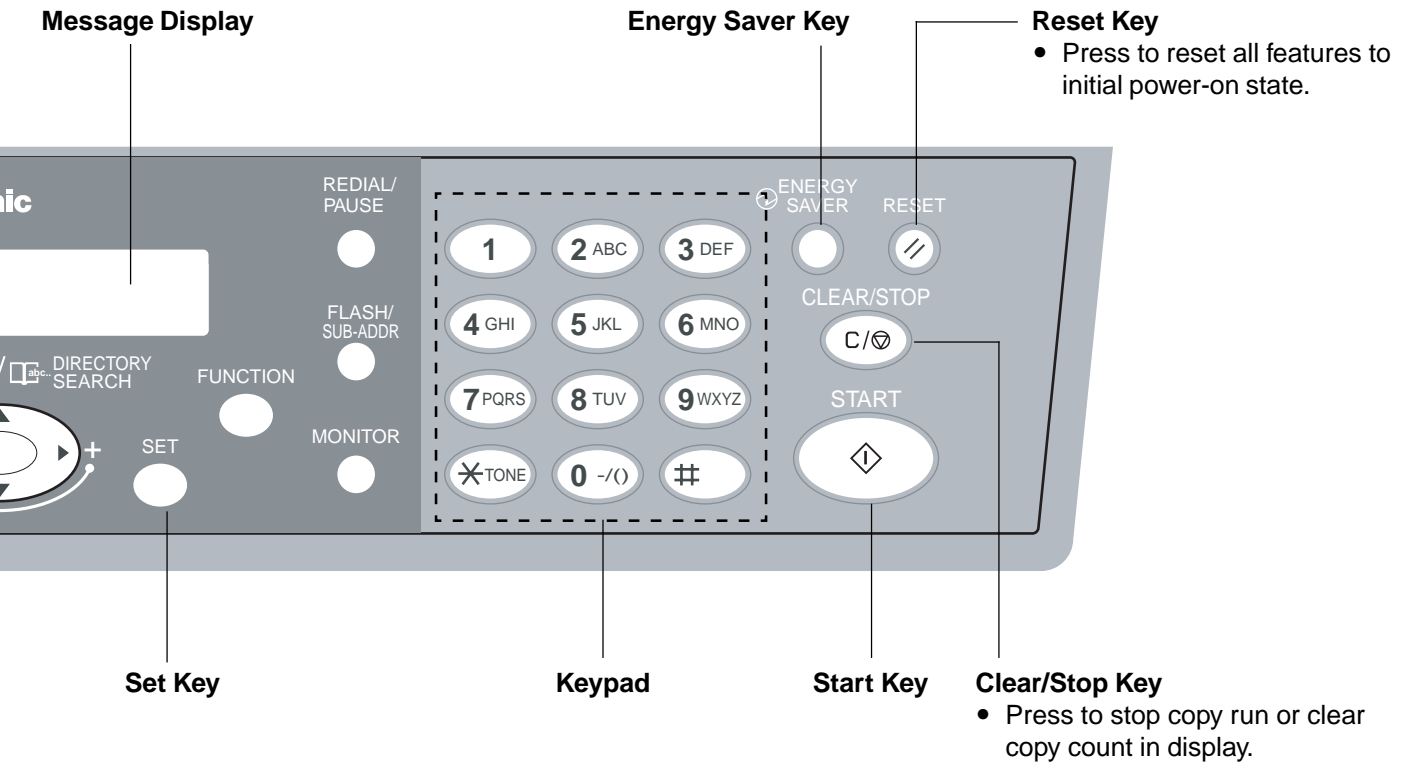

Mode Functions

■ Energy Saver Mode/Sleep Mode

Energy Saver Mode

- ① To enter this mode
Press Energy Saver key. The indicator will flash.
Automatically enters after 15 minutes from the last copy.
- ② To cancel this mode
Press Energy Saver key again.

Sleep Mode

- ① Automatically enters after 30 minutes from the last copy.
Power consumption will drop and the Energy Saver key indicator will light.
- ② To cancel this mode.
Press Energy Saver key.

If you wish to change the above settings or if you need more information, call your Panasonic authorized dealer.

	Power Consumption	Warm Up Time
Normal Operation	Approximately 60 Wh	None
Energy Saver Mode	Approximately 35 W	5 seconds
Sleep Mode	Approximately 1.5 W	25 seconds

■ Toner Saver Mode

- 1) This only works when using copy mode. When printing out by Printer or Fax function, this mode does not work.
- 2) This Toner Saver Mode is to save toner consumption by copying dark originals lighter. The exposure indicator "LIGHTER" flashes when Toner Saver Mode is on.

- 3) To enter this mode:

- ① Press COPY key.
- ② Press FUNCTION key.
- ③ Press "4" key of Keypad
- ④ Press SET key.
- ⑤ Select "TONER SAVER 2:VALID".
Press "2" key of Keypad
- ⑥ Press SET key.

To cancel this mode:

- ① Press COPY key.
- ② Press FUNCTION key.
- ③ Press "4" key of Keypad
- ④ Press SET key.
- ⑤ Select "TONER SAVER 1:INVALID".
Press "1" key of Keypad
- ⑥ Press SET key.

■ Auto Start Function

While the copier is warming up, you may position your original on the copier, enter your copy job selections and press the Start key. The Wait indicator (Start key) will flash until the warm up cycle is completed and the copy job will automatically start.

Note: Please enter your copy job, when "WARM UP, PLEASE WAIT SELECT COPY JOB" appears in message display.

Features

■ Features List

Reduction or Enlargement Copying	(See page 14)	Copying with preset ratios.
Zoom Copying	(See page 15)	Copying with variable zoom ratios.
Digital Skyshot copy	(See page 16)	Copying from small originals without dark areas around the image.
2 Sided Copy	(See page 17)	Copying 2-sided from 1-sided originals.
2 in 1 copy	(See page 18)	Copying from two 1-sided originals, side by side, to 1-sided copies.
2 in 1 copy (2 Sided mode)	(See page 19)	Copying from four 1-sided originals, side by side, to 2-sided copies.
Sorting	(See page 20)	Multiple copies to be sorted automatically.

Common Features

Reduction or Enlargement Copying

■ There are 3 preset reduction and 1 preset enlargement modes.

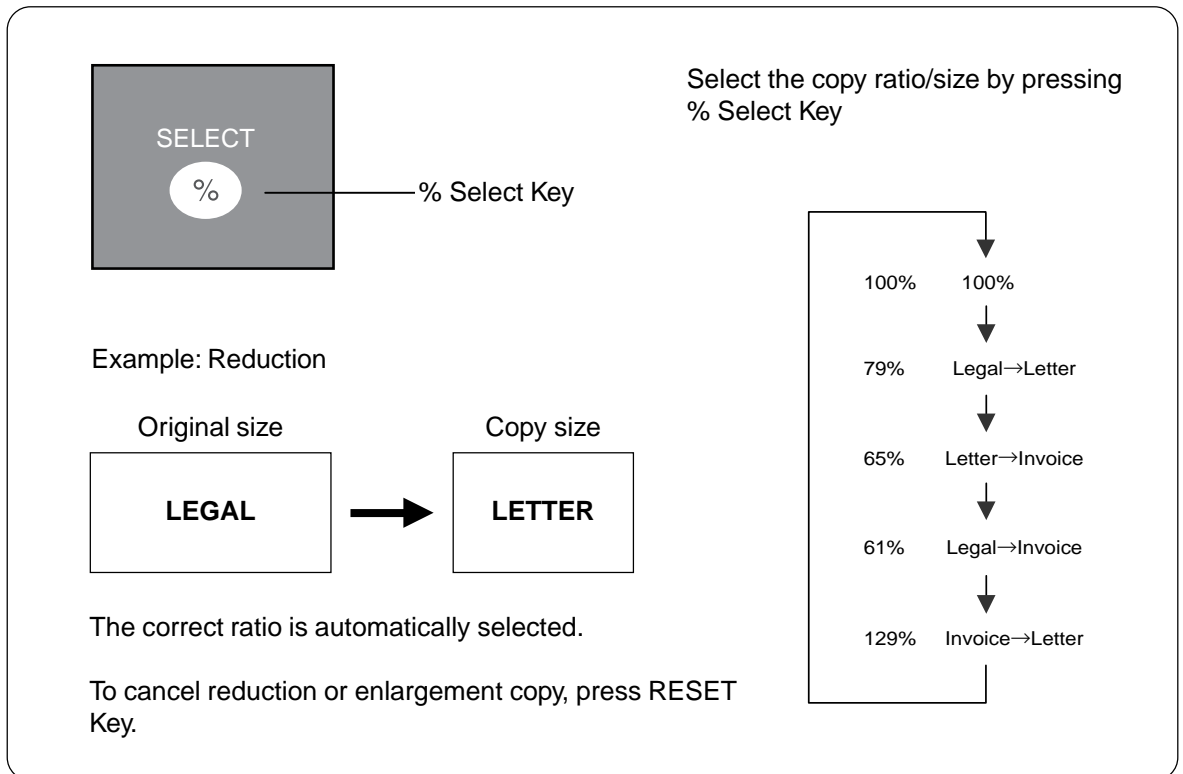
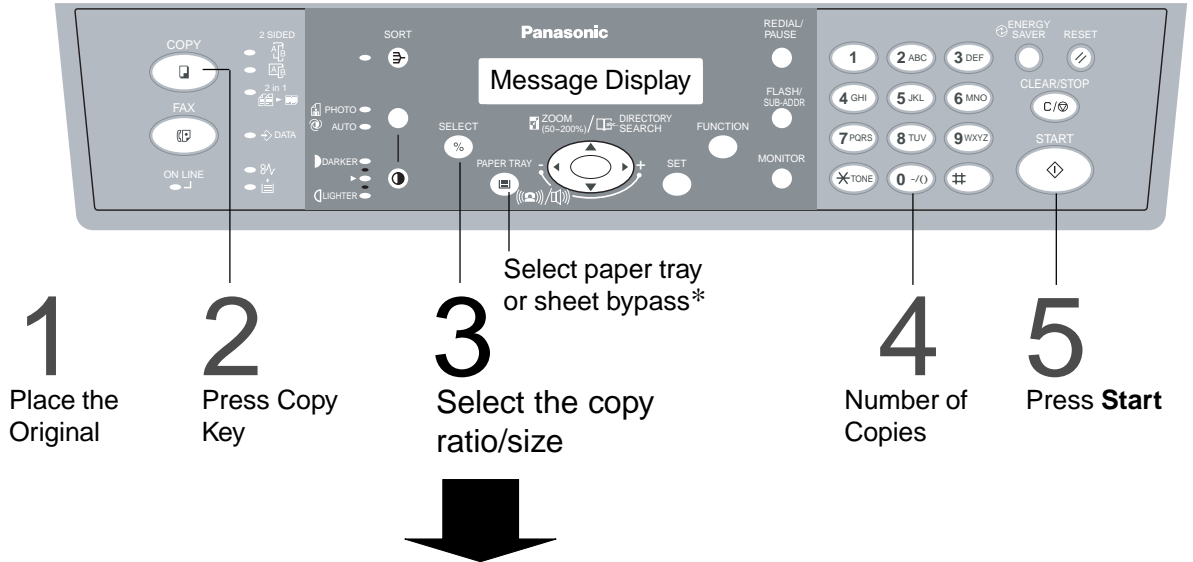

NOTE

- * When copy size is different from paper size of paper tray, select sheet bypass by pressing Paper Tray key and place the paper into the sheet bypass. (See page 21)
- To change the paper size of the paper tray, see page 24.

Zoom Copying

- A zoom ratio can be selected from 50% to 200% in 1% increments.

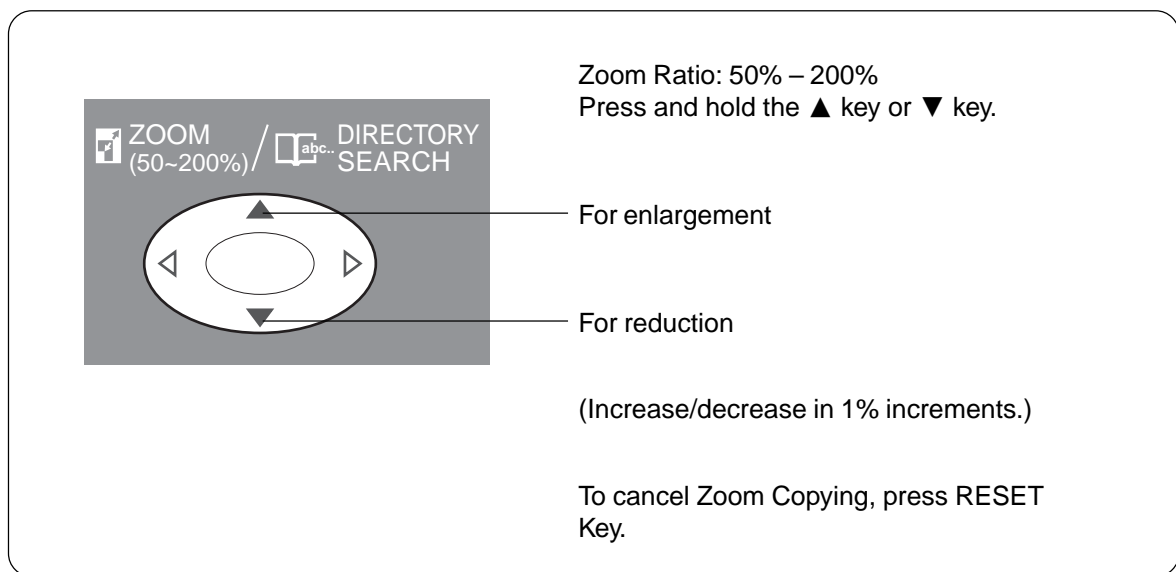
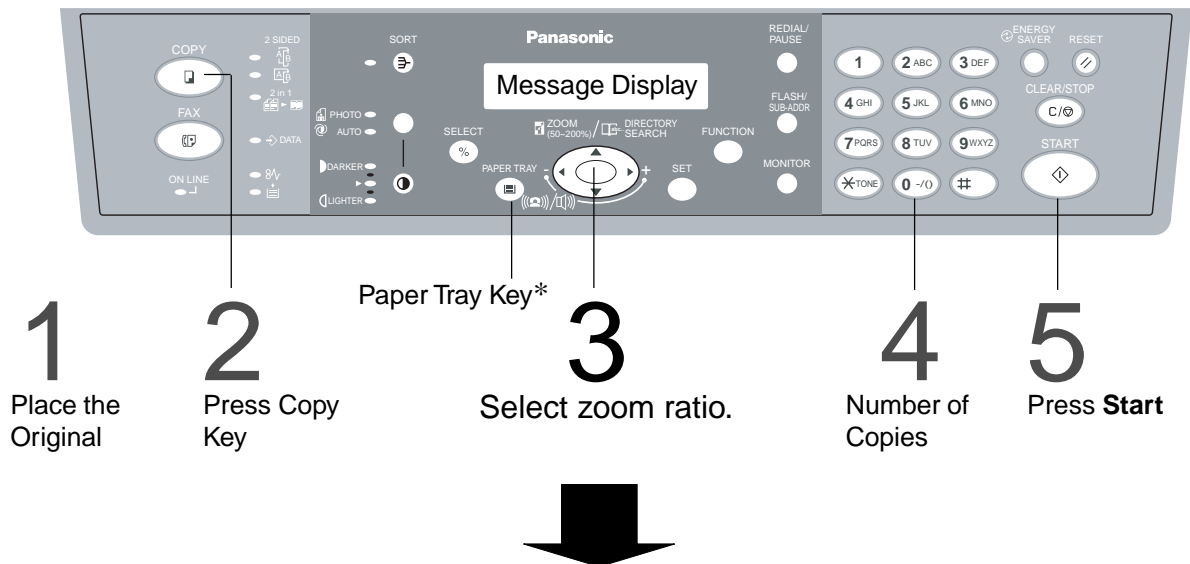

NOTE

- * When copy size is different from paper size of paper tray, select sheet bypass by pressing Paper Tray key and place the paper into the sheet bypass. (See page 21)
- To change the paper size of the paper tray, see page 24.

Creative Features

Digital Skyshot Copy

- To copy from the platen with ADF open. Making copies from small originals without dark areas around the image. The Digital Skyshot mode is normally set on. If the mode is not set, please use the following procedure.

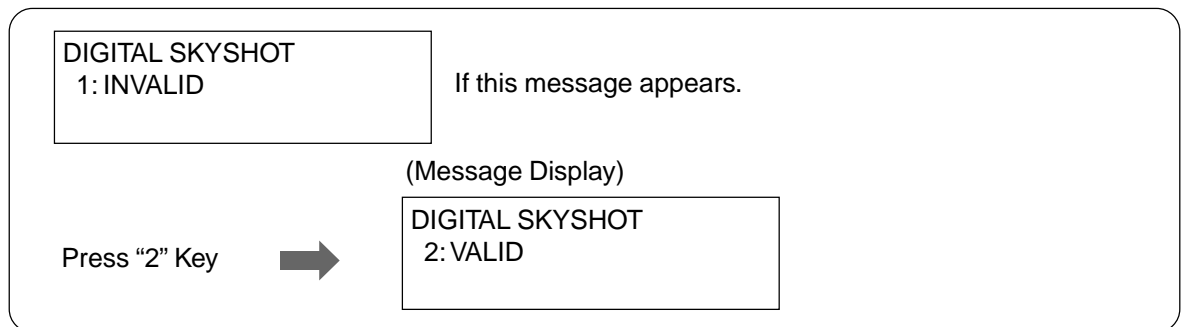
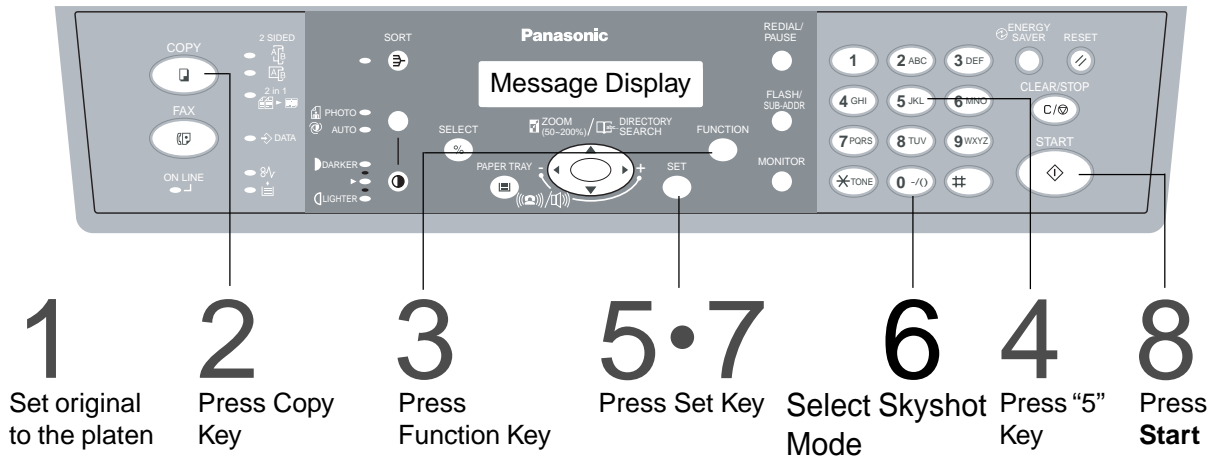

NOTE

- Incorrect erasure may occur if there is not a blank line at the edge of the colored paper or halftone image original which the copier is not detected as a blank pattern in the Digital Skyshot mode.
- Incorrect original position detection may occur if any strong light shines onto the glass during Digital Skyshot mode.
- If the ADF(Automatic Document Feeder) is closed, the Digital Skyshot mode will be invalid.
To cancel this mode completely, select "Skyshot 1: INVALID" in above procedure No 6.

2 Sided Copy

■ For 2-sided copying.

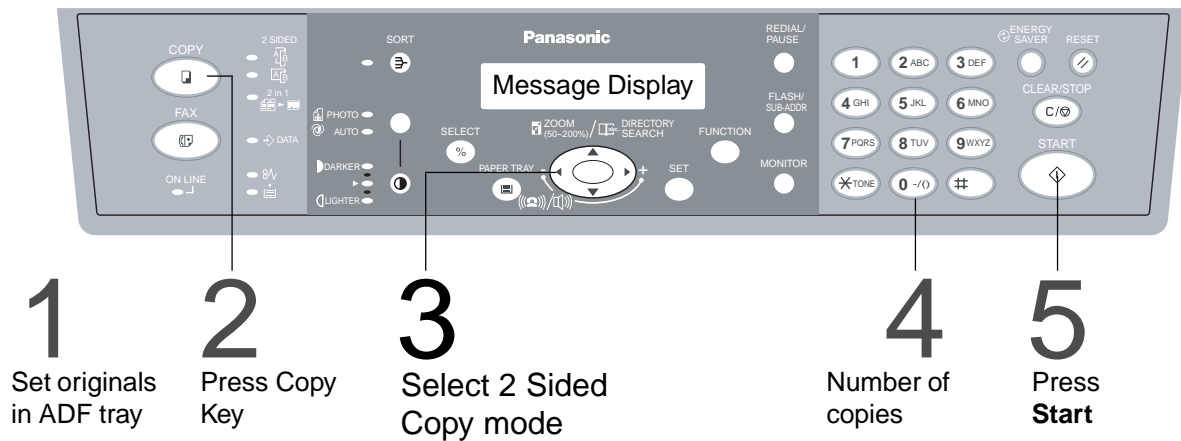

Press ◀ key to select the 2 Sided Copy mode

2 SIDED

1 time: Long Edge

2 times: Short Edge

3 times: Combined with 2 in 1 mode (See page 19)

▲ If mode is changing from Short Edge to Long Edge, press the ▶ key.

Long Edge and Short Edge are as follows

	Original	→	Copy		Original	→	Copy
Long Edge	A B		A B	Long Edge	A B		A B
Short Edge	A B		A B	Short Edge	A B		A B

- ATTENTION**
- 2 sided will not work off the platen glass.
 - Only Legal and Letter size is available for 2-Sided copy. For Legal size, please set the paper into the paper tray. Do not use the sheet bypass.

Creative Features

2 in 1 Copy

■ For 2 in 1 copying.

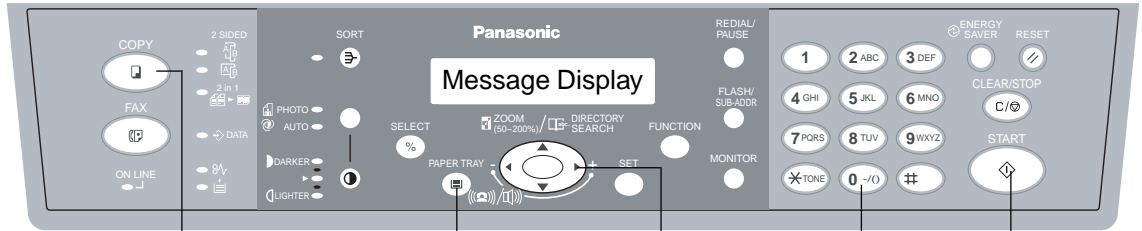

- 1 Set originals in ADF tray
- 2 Press Copy Key
- 3 Select 2 in 1 Mode
- 4 Number of copies
- 5 Press Start

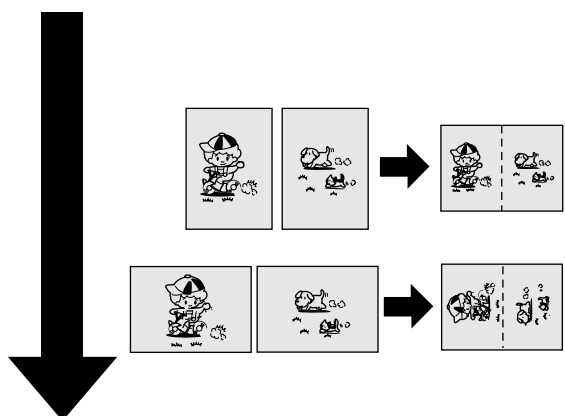
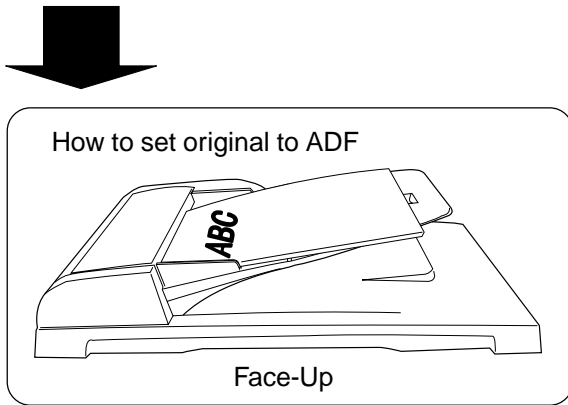

Press ► key to select the 2 in 1 mode

2/3 times: Combined with 2 Sided Copy (See P. 19)

1 time: 2 in 1

▼ To cancel combining with 2 Sided Copy mode, press the ◀ key.

- When copying the 2 in 1 mode from Invoice to Letter or from Legal to Letter, select the preset copy ratio with the % Select Key.

ATTENTION

- * When copy size is different from paper size of paper tray, select sheet bypass by pressing Paper Tray key and place the paper into the sheet bypass. (See page 21)
- To change the paper size of the paper tray, see page 24.
- 2 in 1 will not work off the platen glass.
- When copying the 2 in 1 mode with Invoice size, copy image will be missing.

■ For 2 in 1 copying. (2 Sided mode)

1 Set originals in ADF tray

2 Press Copy Key

3 Select 2 in 1 Mode

4 Number of copies

5 Press Start

Paper Tray Key*

Message Display

How to set original to ADF

Face-Up

Press ► key to select the 2 in 1 mode

3 times: Combined with 2 Sided Copy (Long Edge)

2 times: Combined with 2 Sided Copy (Short Edge)

▼ To change the Long Edge to Short Edge mode of 2 Sided Copy, press the ◀ key.

2 SIDED

2 in 1

% Select key

◀ key

▶ key

NOTE

- * When copy size is different from paper size of paper tray, select sheet bypass by pressing Paper Tray key and place the paper into the sheet bypass. (See page 21)
- To change the paper size of the paper tray, see page 24.
- 2 in 1 (2 sided mode) will not work off the platen glass.

Creative Features

Sorting

Multiple copies to be sorted automatically.

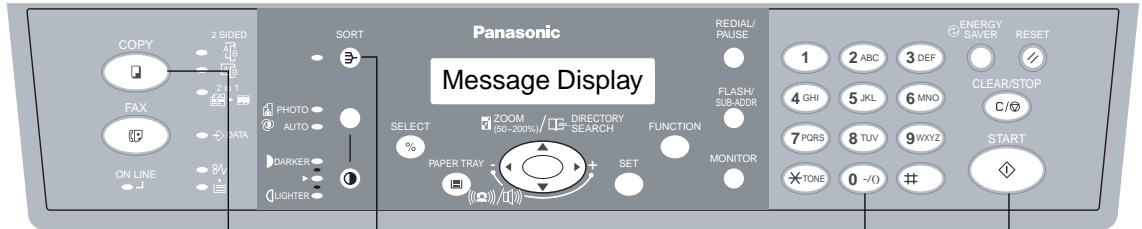

When using ADF

- 1 Set originals in ADF tray
- 2 Press Copy Key
- 3 Press Sort Key
 - The indicator flashes
- 4 Number of Copies
- 5 Press Start

When setting original to the platen

- 1 Set original to the platen
- 2 Press Copy Key
- 3 Press Sort Key
 - The indicator flashes
- 4 Number of Copies
- 5 Press Start
- 6 When the copy of the first original is finished, set the next original
- 7 Press Start
- 8 Continue procedure 6 and 7 until the last original copying is finished. Then press Sort key.
 - The indicator lights up
- 9 Press Start Copying from the 2nd set will start.

Sorting is:

Example: Copying 3 set from 3 originals.

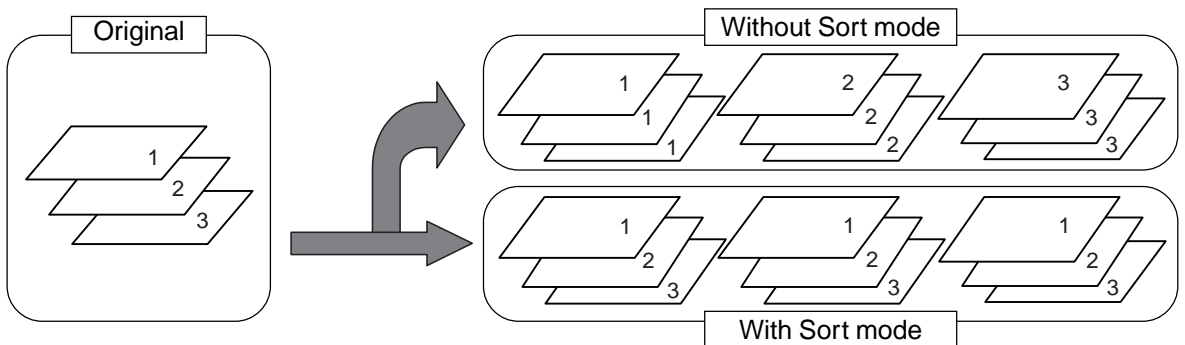

With Sort mode, copies will be sorted as the same order of the original.

- ATTENTION**
- Do not press Sort key when number of copy is one.
 - ADF's(Automatic Document Feeder) scanning may stop in some cases when the memory capacity has overflowed. This may occur especially when scanning halftone originals. In this case, return from the original which did not scan and re-start scanning. Detail procedure will be indicated in the message display.

Using the Sheet Bypass

- To copy on printed paper, letterhead, mailing labels, transparencies and odd-size paper, etc., or to use the bypass as an additional paper source.

1

Position original.
Select copy ratio/size.
(See page 14)

2

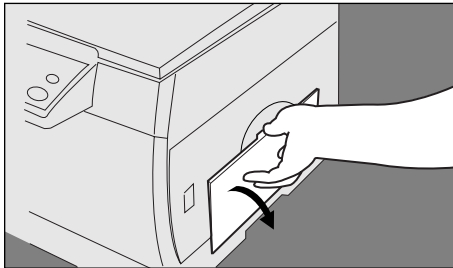

Open the sheet bypass.

3

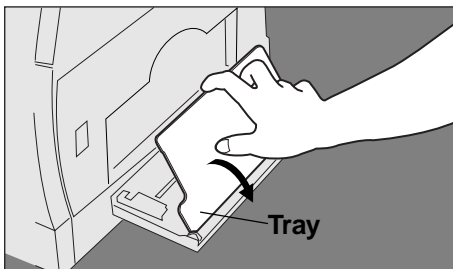

Open the tray.

4

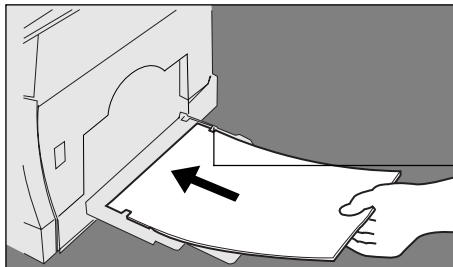

- ① Place paper into the tray. (Up to 50 sheets)
Insert the paper until it stops.

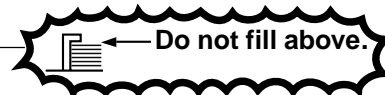

Copy side down for copying on letterhead paper and mailing labels.

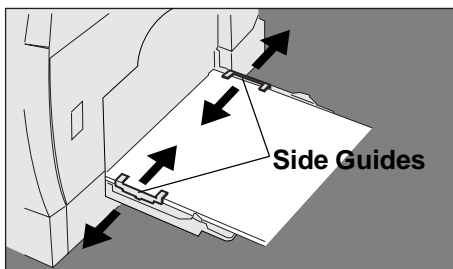

- ② Adjust the side guides to paper width.
Incorrect adjustment may cause paper to wrinkle, misfeed or skew.

5

Select sheet bypass with Paper Tray key.

NOTE

- When using printed paper, do not set more than 25 (20 lbs.) sheets in bypass.
- Some types of mailing labels and transparency film may damage your machine. Contact your service provider for advice regarding non-standard paper types.

Option

Option

■ 2nd Paper Feed Module (DA-DS150)

Available to add 250-sheet paper tray.

- For installation, see the Installation Instructions provided.
- For setting and changing paper size, see page 24.

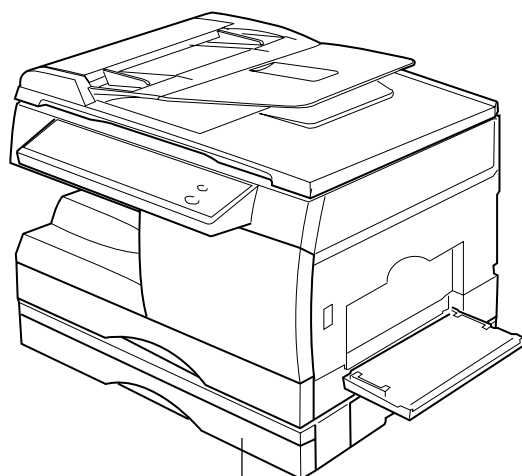

2nd Paper Feed Module
(DA-DS150)

The illustration is the main unit with optional 2nd Paper Feed Module.

Handling

Adding Paper

■ Use the following steps to add paper.

1

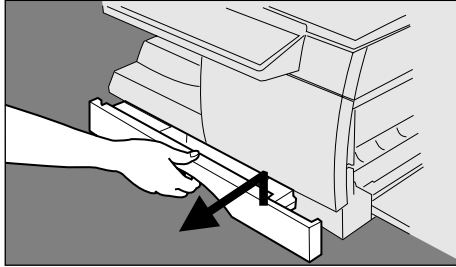

Lift paper tray and pull out of the copier until it stops.

2

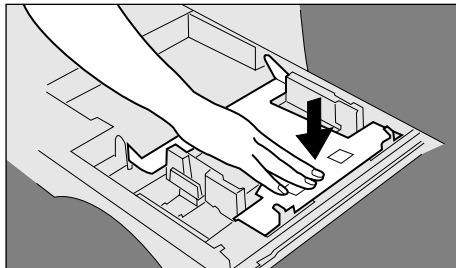

Push the bottom plate down until it locks.

3

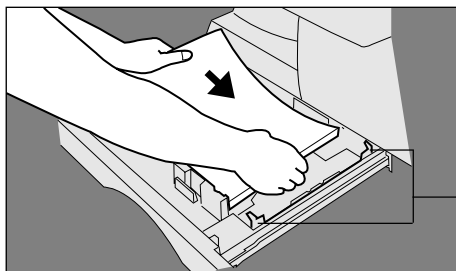

Place paper into paper tray.

How to place paper:
Place the paper copy side up.



4

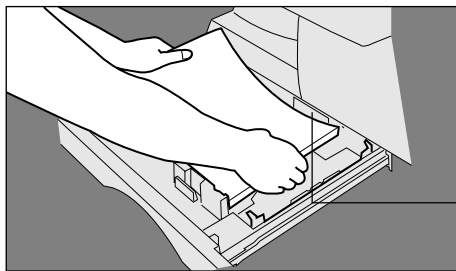

Make sure paper is not loaded above overfill indicator located in the paper tray.

Overfill Indicator

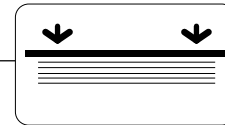

← 1-sided copy

5

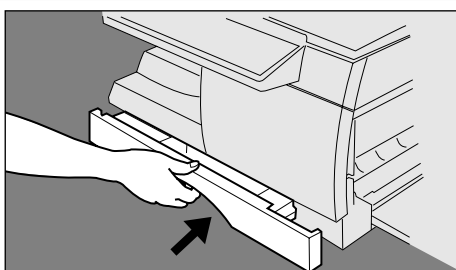

Push paper tray back into copier.

NOTE

- Special papers, like glossy paper, mailing labels and transparencies cannot be used in the paper tray. Use bypass for special paper.
- When using copied paper, use the sheet bypass.
- If the paper tray is not closed completely, the Add Paper Indicator in the control panel will light up. In that case, please close the paper tray completely.

Handling

Changing Paper Size

- Following is the procedure to change paper size of paper tray from the control panel. This procedure is also same for optional 2nd Paper Feed Module.

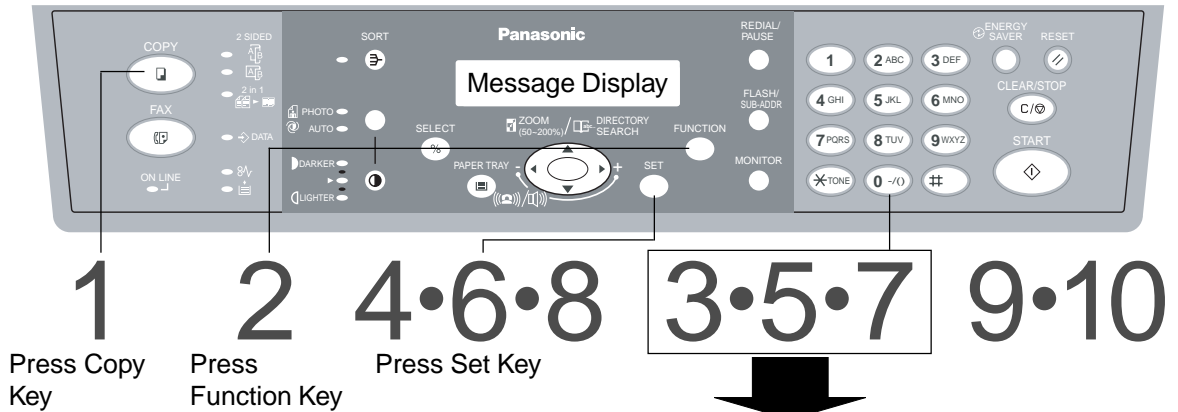

3 Press "3" Key → 3: PAPER SIZE ?
PRESS SET TO SELECT appears in the message display.

5 Press "1" or "2" Key → Press "1" to select standard 250-sheet paper tray
Press "2" to select optional 2nd Paper Feed Module*1

7 Select paper size by Keypad →

1: LETTER	4: A4	7: FLS (8" × 13")
2: LEGAL	5: B5	8: FLS (8.5" × 13")
3: INVOICE	6: A5	0: NOT INSTALLED*2

- After changing paper size from the control panel, change the paper size of paper tray by following procedure.

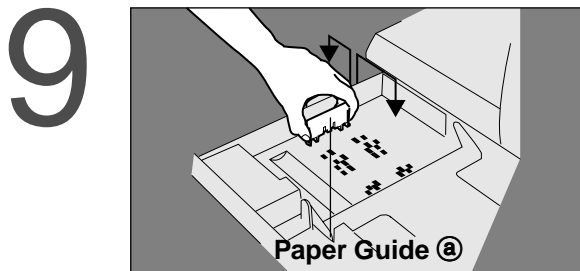

- Lift paper tray and pull out of the copier until it stops.
- Move the paper guide (a) to the paper length required.

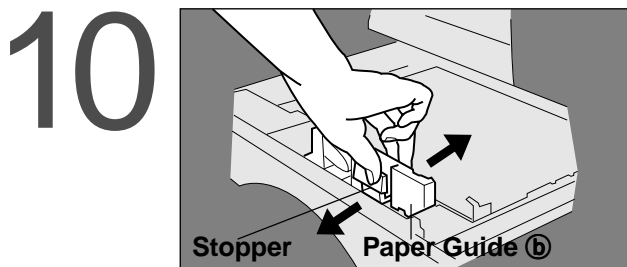

- Move the paper guide (b) to the paper width required.
Squeeze the stopper to move the paper guide (b) to the desired paper size.
- Push paper tray back into copier.

ATTENTION

- Please change the paper size of 2nd Paper Feed Module by same procedure.
- *1 When the optional 2nd Paper Feed Module is not installed, set to "TRAY 2 0: NOT INSTALLED".
- *2 "TRAY 2 0: NOT INSTALLED" is available to select only when optional 2nd Paper Feed Module is selected at the procedure 5.

Changing Toner Cartridge

■ Message will appear in the message display when needs to add toner.

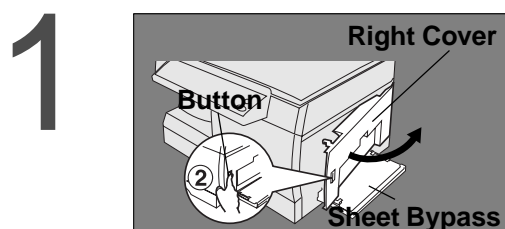

- ① Open the sheet bypass.
- ② Push the button.
- ③ Open the right cover.

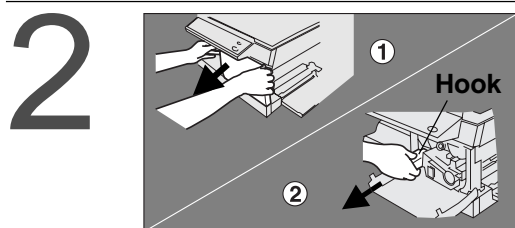

- ① Open the front panel.
Do not open the front panel first. It can not be opened unless you open the covers shown in procedure 1.
- ② Pull the green hook of toner cartridge.

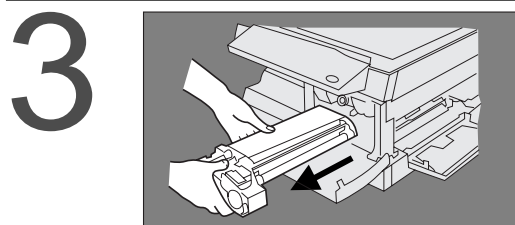

Remove the toner cartridge.

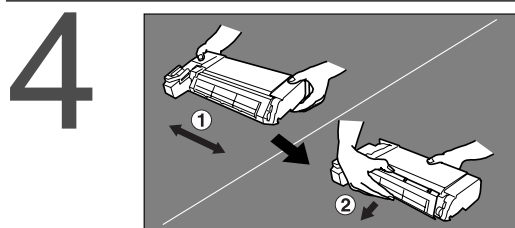

- ① Shake the new toner cartridge several times.
- ② Take off the new toner cartridge cover (white plastic) and discard.

Do not stand the toner cartridge on end!

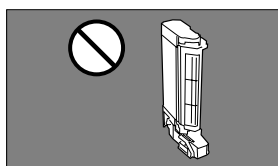

Do not touch the magnetic roller!

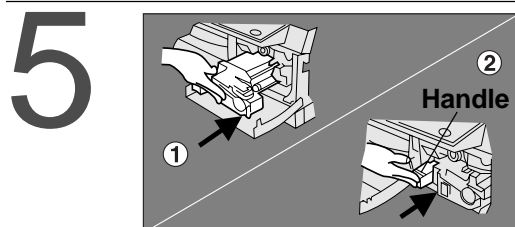
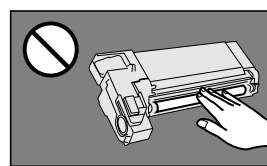

- ① Install new toner cartridge.
- ② Push the green handle until it locks.
- ③ Close the front panel.
- ④ Close the right cover. (See page 9)
- ⑤ Close the sheet bypass.

ATTENTION

- To maintain optimum performance, we recommend only using genuine Panasonic supplies and parts. Store toner cartridge in a cool dark place. Install toner cartridge immediately after unsealing.

Handling

Changing Drum Unit

- Message will appear in the message display when needs to change drum unit.

1

- ① Open the sheet bypass.
- ② Push the button and open the right cover.
- ③ Open the front panel.
- ④ Remove the toner cartridge.

For detail procedure, see page 25.
(Procedure 1 to 3)

2

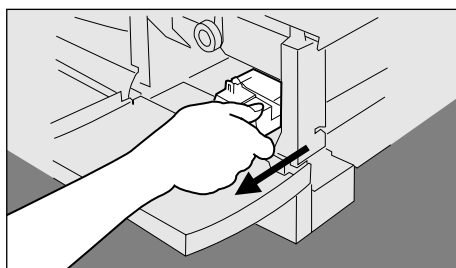

Remove the drum unit by pulling the handle with green label.

3

Take out the new drum unit from the plastic bag.

4

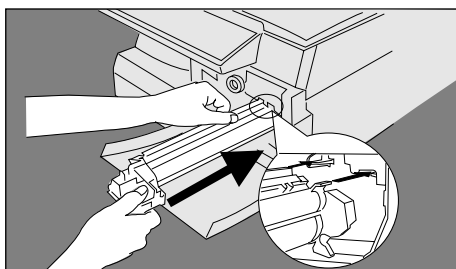

Replace new drum unit by aligning the arrows on the drum unit with those of the copier.

5

- ① Replace the toner cartridge.
(See page 25)
- ② Close the front panel.
- ③ Close the right cover.
(See page 9)
- ④ Close the sheet bypass.

ATTENTION

- To maintain optimum performance, we recommend only using genuine Panasonic supplies and parts.
Store drum unit in a cool dark place. Do not unseal drum unit before use.
Use it as fast as possible after unsealing.
- Do not touch or scratch the surface of the drum.

Removing a Paper Misfeed (Main Unit)

■ Paper transport and paper entry areas

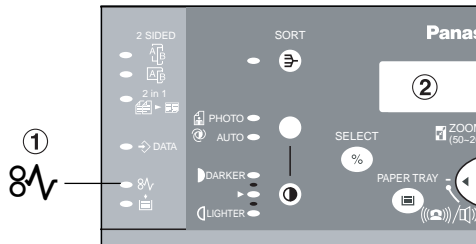

When a paper misfeed has occurred

- ① Paper Misfeed Indicator will light.
- ② Paper misfeed message will appear in the message display.

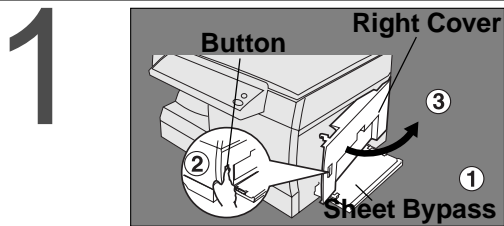

- ① Open the sheet bypass.
- ② Push the button.
- ③ Open the right cover.

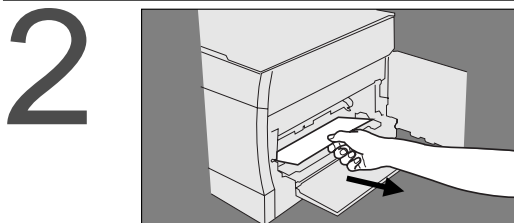

Remove the misfed paper.

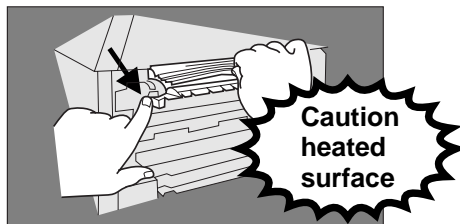

In case the jam is in fuser unit:

- ① Open the fuser cover.
- ② Remove misfed paper.

Caution: this fuser area will be hot.

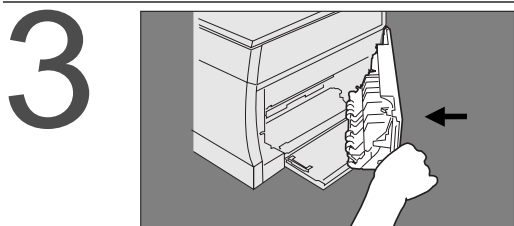

Close the right cover.

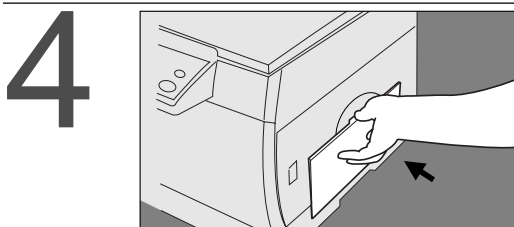

Close the sheet bypass.

ATTENTION

- Make sure that the misfeed indicator goes off after removing a paper misfeed. The misfeed indicator will not go off if the paper is still jammed in the copier. Check again and remove all misfed paper.
- Do not touch or scratch the surface of the drum.

Handling

Removing a Paper Misfeed (Main Unit)

■ Paper exit area

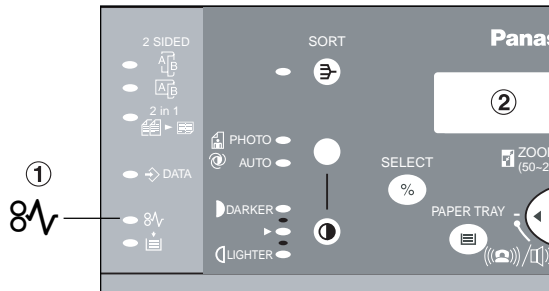

When a paper misfeed has occurred

- 1 Paper Misfeed Indicator will light.
- 2 Paper misfeed message will appear in the message display.

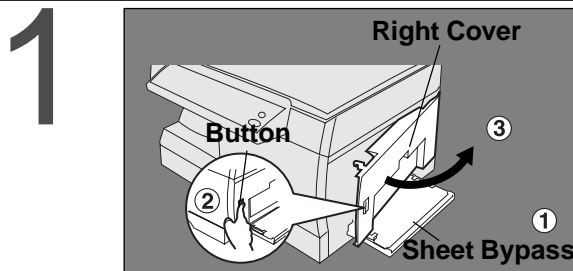

- 1 Open the sheet bypass.
- 2 Push the button.
- 3 Open the right cover.

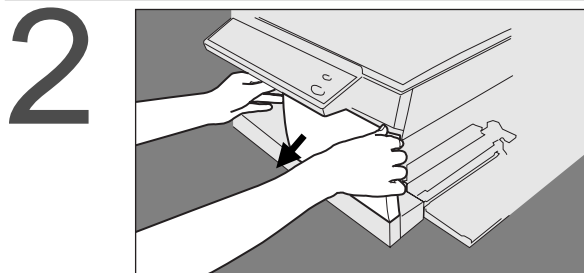

Open the front panel.

Do not open the front panel first. It can not be opened unless you open the covers shown at procedure 1.

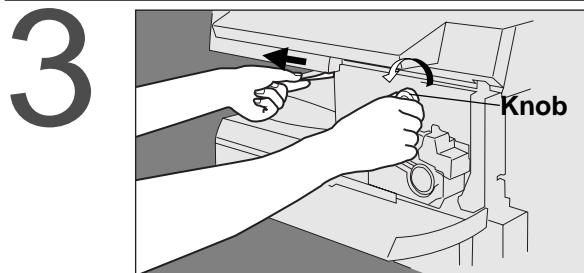

- 1 Turn the knob.
- 2 Remove the misfed paper.

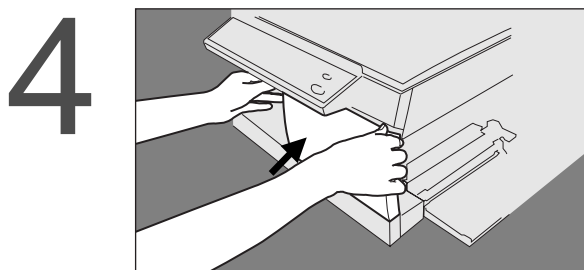

- 1 Close the front panel.
- 2 Close the right cover. (See page 9)
- 3 Close the sheet bypass.

ATTENTION

- Make sure that the misfeed indicator goes off after removing a paper misfeed. The misfeed indicator will not go off if the paper is still jammed in the copier. Check again and remove all misfed paper.

Removing an Original Misfeed (ADF)

■ ADF (Automatic Document Feeder) area

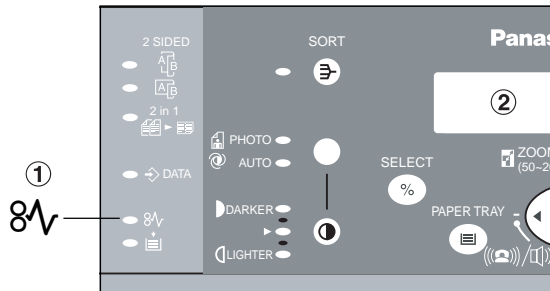

When an original misfeed has occurred

- ① Paper Misfeed Indicator will light.
- ② Paper misfeed message will appear in the message display.

1

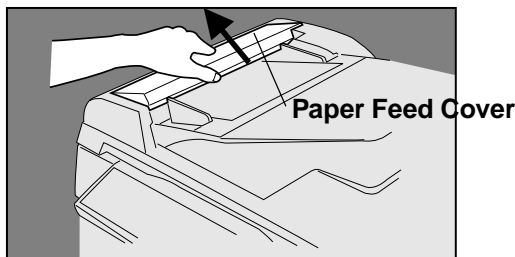

Paper Feed area:
Open paper feed cover of ADF.

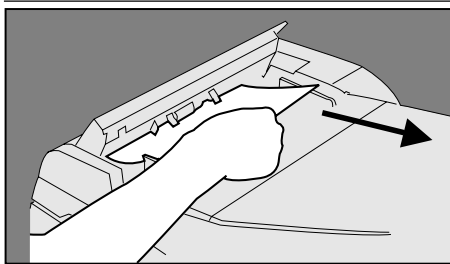

Remove misfed paper and close paper feed cover.

2

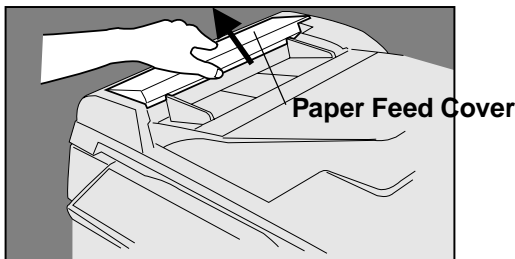

Paper Exit Area:
Open paper feed cover of ADF.

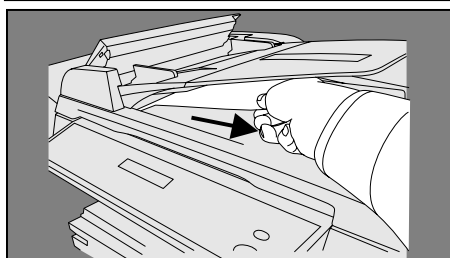

Remove misfed paper and close paper feed cover.

ATTENTION

- Make sure that the misfeed indicator goes off after removing the misfed paper. The misfeed indicator will not go off if an original is still jammed in the ADF. Check again and remove the misfed original.

Handling

Removing a Paper Misfeed (Automatic Duplex Unit)

■ Automatic Duplex Unit area

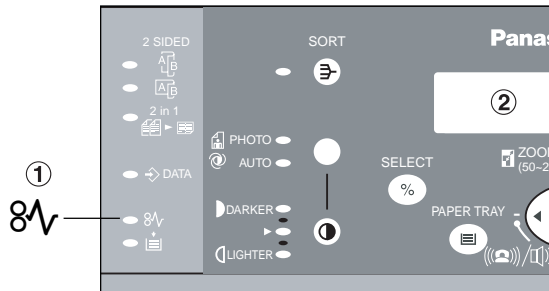

When a paper misfeed has occurred

- 1 Paper Misfeed Indicator will light.
- 2 Paper misfeed message will appear in the message display.

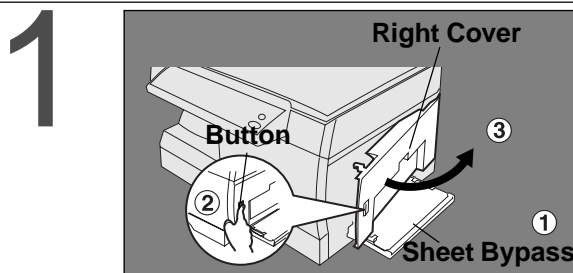

- 1 Open the sheet bypass.
- 2 Push the button.
- 3 Open the right cover.

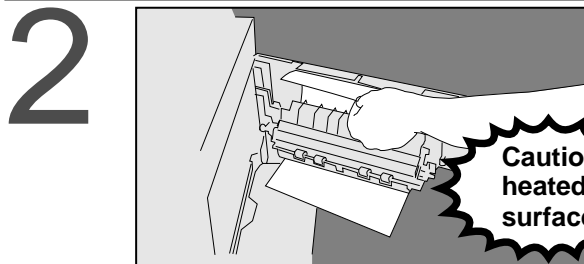

Remove the misfed paper.

Caution: this fuser area will be hot.

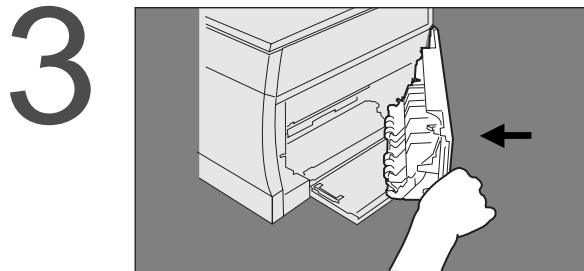

Close the right cover.

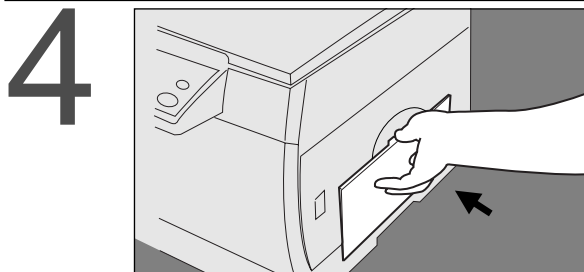

Close the sheet bypass.

ATTENTION

- Make sure that the misfeed indicator goes off after removing a paper misfeed. The misfeed indicator will not go off if the paper is still jammed in the copier. Check again and remove all misfed paper.

Removing a Paper Misfeed (2nd Paper Feed Module)

■ 2nd Paper Feed Module area

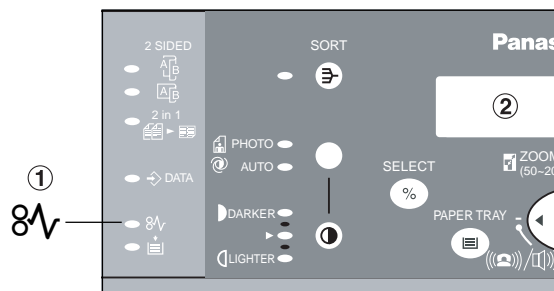

When a paper misfeed has occurred

- ① Paper Misfeed Indicator will light.
- ② Paper misfeed message will appear in the message display.

1

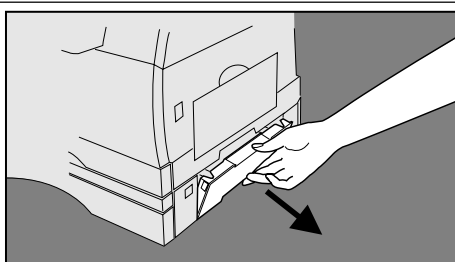

Open paper feed cover.

2

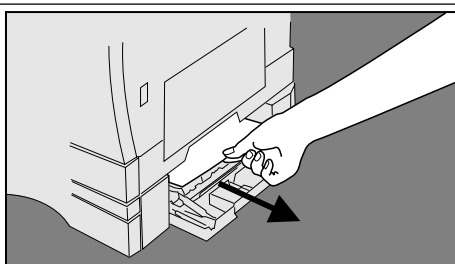

Remove the misfed paper.

3

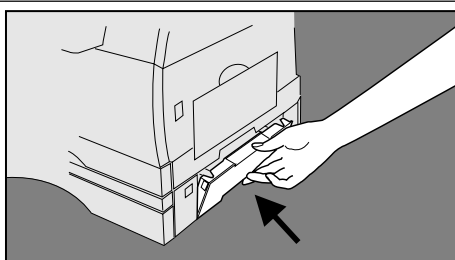

Close paper feed cover.

4

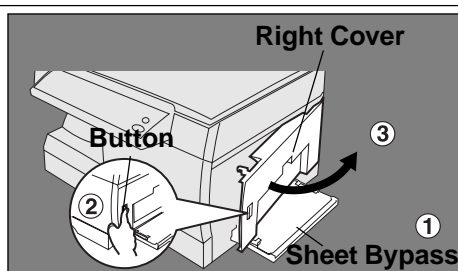

To clear the paper misfeed indicator.

- ① Open the sheet bypass.
- ② Push the button.
- ③ Open the right cover.
- ④ Close the right cover.
- ⑤ Close the sheet bypass.

ATTENTION

- Make sure that the misfeed indicator goes off after removing the misfed paper. The misfeed indicator will not go off if the paper is still jammed in the copier. Check again and remove all misfed paper.
- Do not open the rear cover of the 2nd Paper Feed module. And do not touch to the gear area. Fingers might be wedged between gears.

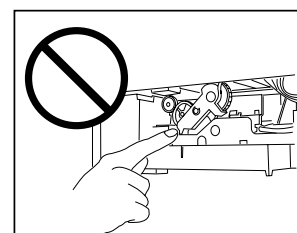

Checking

Troubleshooting

Check

Action

Unit does not operate

Does the display light up?	➔	Check if the Power Switch is turned on and if the power plug is inserted into the outlet.
Is Energy Saver key flashing?	➔	Press Energy Saver key on control panel.
Does the Add Paper Indicator appear on display? (⏏)	➔	Add paper. (See page 23) or check if the paper tray is closed completely. When the 2nd paper feed module is not installed, the paper size should be selected "0: Not installed". (See page 24)
Does the Paper Misfeed Indicator appear on display? (8V)	➔	Remove misfed paper. (See page 27-31)
Does "CLOSE RIGHT COVER" appear on message display?	➔	Right cover is open. Please close it.
Does U19 appear on message display?	➔	Check if toner cartridge is installed completely. (See page 25)
Does "CLOSE ADF" appear on message display?	➔	Close ADF (Automatic Document Feeder)
Does U40 appear on message display?	➔	Add paper to the sheet bypass and press Start.
Does any of the E#-## appear on display?	➔	Turn copier power switch off, then back on. If error code comes back again, call your Panasonic authorized dealer.
Does "INFO. CODE=###" message appear on display?	➔	Refer to the Information Codes of the Operating Instructions (For Facsimile) on page 89.
Does "JAN-01-1999" appear on message display?	➔	Replace the Lithium Battery, refer to operating instructions (For Facsimile).

Copies are marked

Is the copier platen glass or platen cover dirty?	➔	Clean the glass or platen cover. (See page 33)
Is the corona dirty?	➔	Need to clean corona. (See page 34)
Is the back side of copies dirty?	➔	Clean the roller. refer to operating instructions (For Facsimile).

Copies are light

Does the exposure indicator say "light"?



Press Auto/Photo Select Key to choose the auto mode. (See page 2)

Does the add toner message appear on the message display?



Change toner cartridge. (See page 25)

Light image on the front side of copier

Copy Image Sample



Image towards the front side of copier is light.



Push the green handle of the toner cartridge to right.

← Direction of paper exit

■ If the measures outlined above do not solve the problem, call your Service provider.

Care of Copier

■ As a rule, clean weekly.

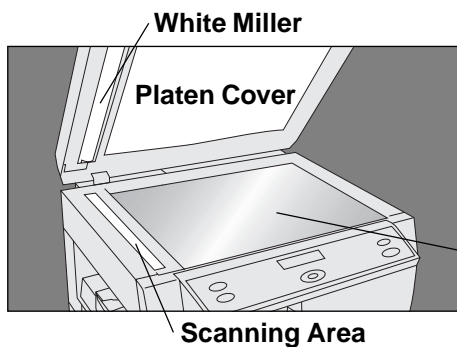

- ① Wipe marks off with cloth and a neutral detergent.
- ② Wipe again with a dry cloth.

■ As a rule, clean monthly.

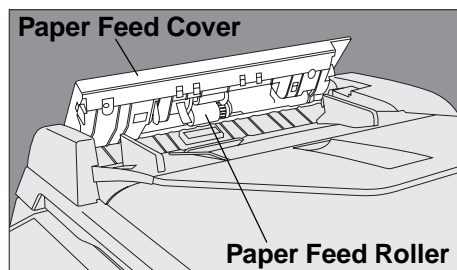

<Paper Feed Roller>

- ① Open the Paper Feed cover.
- ② Wipe paper feed roller with cloth and neutral detergent.
- ③ Wipe again with a dry cloth.

ATTENTION

- Do not use benzine, thinners or other volatile cleaners.

Checking

■ When copies become unclear, clean the corona by following procedure.

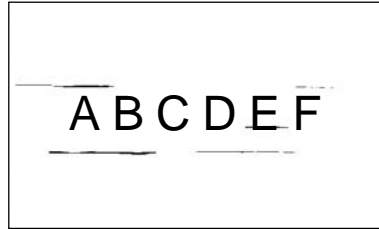

(Sample)

Line images in the copy.

1

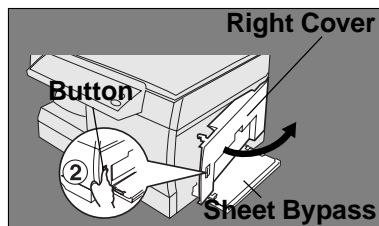

- ① Open the sheet bypass.
- ② Push the button.
- ③ Open the right cover.
- ④ Open the front panel.
- ⑤ Pull the green hook of toner cartridge.

2

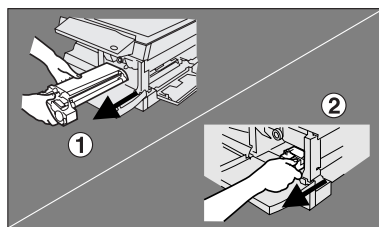

- ① Remove the toner cartridge.
- ② Remove the drum unit by pulling the handle with green label.

3

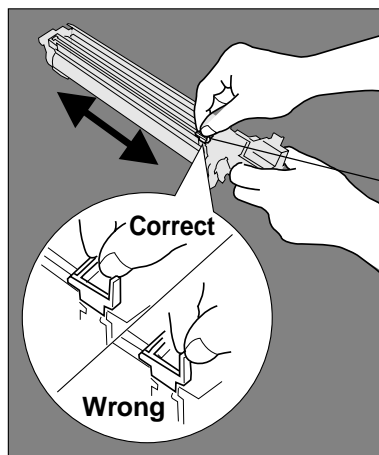

Corona Cleaner
(Original Position)

- ① Slide corona cleaner (green) back and forth one or two times.
- ② Put the corona cleaner to original position.

4

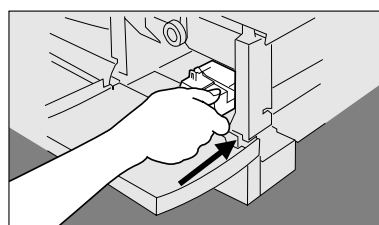

Reinstall the drum unit.

5

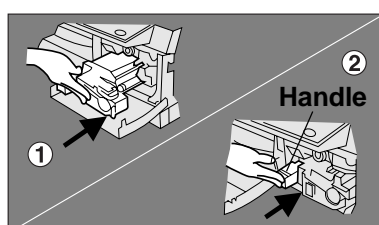

- ① Reinstall the toner cartridge.
- ② Push the green handle until it locks.
- ③ Close the front panel.
- ④ Close the right cover. (See page 9)
- ⑤ Close the sheet bypass.

Specifications

Copier Functions

■ Main unit

Type:	Desk Top
Copy/Print Process:	Laser/Electrostatic photographic method
Process:	Mono-component Ultra Magnefine™ Toner
Resolution:	Max. 600 dpi
Multi-Copy Speed:	15 letter size copies per minute
Maximum Original Size:	8.5" × 14" (Legal size) Void area: max. 5.0 mm
Copy Size:	Legal - Invoice via paper tray Legal - Invoice via sheet bypass
Reduction Ratios:	Preset: 79%, 65%, 61% Variable: from 99% to 50% in 1% increments
Enlargement Ratios:	Preset: 129% Variable: from 101% to 200% in 1% increments
Paper Feed:	250 sheet paper tray plus 50 sheet bypass
Quantity Selector:	1 - 99, Automatic Repeat, Automatic Reset to 1
Paper Weight:	16 - 24 lbs. (Paper tray) 15 - 34 lbs. (Sheet bypass)
Exposure Control:	Automatic/Manual plus Photo Mode
Dimensions (W)(D)(H):	19.5" (W) × 19.2" (D) × 15.1" (H) (with ADF)
Weight:	50 lbs (including ADF)
Electrical Requirement:	AC 120V, 50/60Hz, 8A

■ ADF (Automatic Document Feeder)

Original Capacity:	30 sheets (20 lbs.)
Paper Size:	Invoice R, Letter R, Legal
Paper Weight:	13-28 lbs.
Electrical Requirements:	Supplied from the copier
Dimensions (W)(D)(H):	19.5" (W) × 17.2" (D) × 4.3" (H)

■ 2nd Paper Feed Module (DA-DS150) (Option)

Paper Size:	Invoice R, Letter R, Legal
Paper Weight:	16-24 lbs.
Paper Capacity:	250 sheets
Electrical Requirements:	Supplied from the copier
Dimensions (W)(D)(H):	19.5" (W) × 17.2" (D) × 3.5" (H)
Weight:	7 lbs.

Note: To see total count of copies, press and hold % Select key, then press CLEAR/STOP key.

Consumables List

■ Consumables List

When ordering consumables, please use the correct part number as listed below.

Consumable Name	Part Number	Yield
Toner Cartridge	DQ-UG15A	Approx. 5,000 sheets*
Drum Unit	DQ-UH32A	Approx. 30,000 sheets

* Based on copying onto letter-size 6% image original.

Note: To see total count of copies, press and hold % Select key, then press CLEAR/STOP key.
To print total count of copies, press and hold % Select key, then press START key.

NOTE

NOTE

U.S.A. only

WARRANTY

“PANASONIC DOCUMENT IMAGING COMPANY MAKES NO WARRANTIES, GUARANTEES OR REPRESENTATIONS, EXPRESSED OR IMPLIED, TO CUSTOMER WITH RESPECT TO THIS PANASONIC COPIER, INCLUDING BUT NOT LIMITED TO, ANY IMPLIED WARRANTY OF MERCHANTABILITY OR FITNESS FOR A PARTICULAR PURPOSE.

PANASONIC DOCUMENT IMAGING COMPANY ASSUMES NO RISK AND SHALL NOT BE SUBJECT TO LIABILITY FOR ANY DAMAGE, INCLUDING, BUT NOT LIMITED TO DIRECT, INDIRECT, SPECIAL, INCIDENTAL OR CONSEQUENTIAL DAMAGES OR LOSS OF PROFITS SUSTAINED BY THE CUSTOMER IN CONNECTION WITH THE USE OR APPLICATION OF THIS PANASONIC COPIER. SEE YOUR DEALER FOR DETAILS OF DEALER’S WARRANTY.”

IMPORTANT INFORMATION

When requesting information, supplies or service always refer to the model and serial number of your machine. The model and serial number plate (Main Name Plate) is located on the rear side of machine. For your convenience, space is provided below to record information you may need in the future.

Model No.

Serial No.

Date of Purchase

Dealer

Address

Telephone Number

()

Supplies Telephone Number

()

Service Telephone Number

()

Panasonic Document Imaging Company
A Division of Matsushita Electric Corporation of America
Two Panasonic Way
Secaucus, New Jersey 07094

Panasonic Canada Inc.
5770 Ambler Drive, Mississauga,
Ontario L4W 2T3