

Operating Instructions

Color Video Printer

AG-EP50

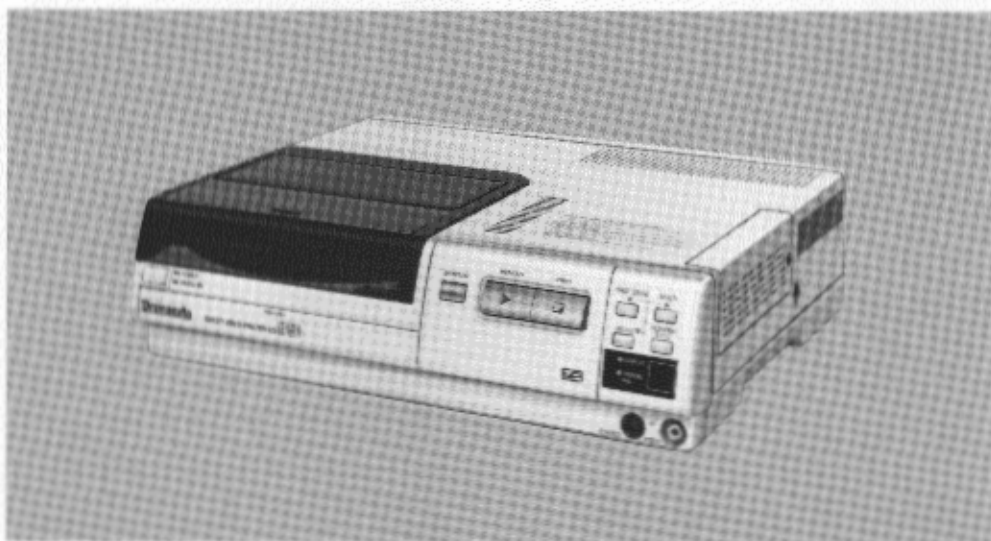

Panasonic

Before attempting to connect, operate or adjust this product, please read these instructions completely.

VQT6110

WARNING:

TO REDUCE THE RISK OF FIRE OR SHOCK HAZARD, DO NOT EXPOSE THIS EQUIPMENT TO RAIN OR MOISTURE.

WARNING:

Unauthorized recording of copyrighted television programs, films, video tapes and other materials may infringe on the rights of copyright owners and be contrary to copyright laws.

CAUTION:

TO REDUCE THE RISK OF FIRE OR SHOCK HAZARD, AND ANNOYING INTERFERENCE, USE THE RECOMMENDED ACCESSORIES ONLY.

FCC NOTE:

This device complies with Part 15 of the FCC Rules.

To assure continued compliance follow the attached installation instructions and do not make any unauthorized modifications.

This equipment has been tested and found to comply with the limits for a Class A digital device, pursuant to Part 15 of the FCC Rules. These limits are designed to provide reasonable protection against harmful interference when the equipment is operated in a commercial environment.

This equipment generates, uses, and can radiate radio frequency energy and, if not installed and used in accordance with the instruction manual, may cause harmful interference to radio communications.

Operation of this equipment in a residential area is likely to cause harmful interference in which case the user will be required to correct the interference at his own expense.

Table of Contents

Preparations

Controls and Components	4
Connections	6
Inserting the Printing Paper	8
Inserting the Ink Cassette	8

Basic Operations

Normal Printing	10
Printing a Series of Different Pictures on the Same Print (Multi Print)	12

Advanced Operations

Using the Menu Mode	14
Selecting the Number of Prints (PRINT Q'TY)	16
Selecting the Input Jack (INPUT)	16
Selecting the Printing Format (FORMAT)	18
1 Printing a Sequence of Different Pictures on the Same Print (MULTI)	18
2 Printing the Same Picture Repeatedly on the Same Print (DIVIDE)	20
3 Printing an Enlarged Part of the Picture (ZOOM)	20
4 Printing a Sequence of Pictures Taken at Fixed Intervals on the Same Print (STROBE)	22
Adjusting the Picture Quality (VIDEO ADJ)	24
Setting Up Special Functions (SET UP)	26
Selecting the Operation Mode of the External Remote Controller (EXT REMOTE)	28
Remote Control Operation from External Equipment	30

Notes, Others

Precautions for Safety	31
Cautions for Use	32
Error Indications	35
Before Requesting Service	35
Specifications	36

Supplied Accessory

Power Cable

Usable Paper for Printing

The following two types of paper can be used with this Color Video Printer. (It is recommended to use Video Print Sets and Video Print Ink Cassettes bearing the "  " logotype.)

- Standard Type Paper

The optional Video Print Set (VW-MPS50P, 50 sheets/set) is necessary.

The printing paper is of sufficient size and thickness to be mailed as postcard (after affixing stamps).

- Adhesive Paper

The optional Video Print Set (VW-MPSS25P, 25 sheets/set) is necessary.

Controls and Components

[Front Panel]

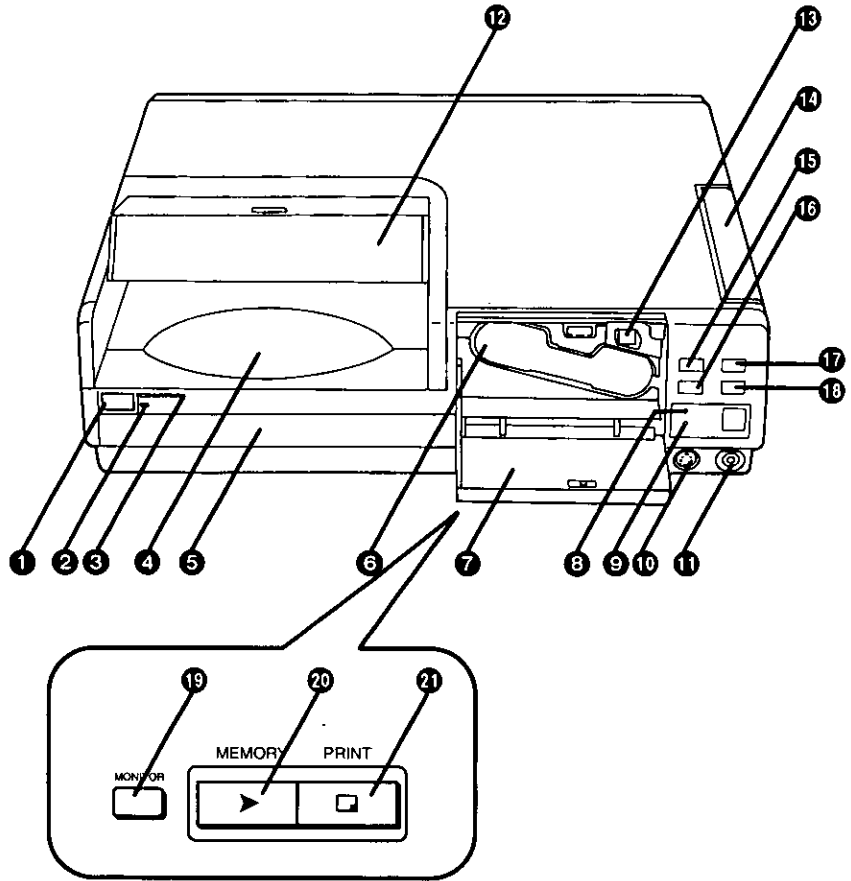

[Rear Panel]

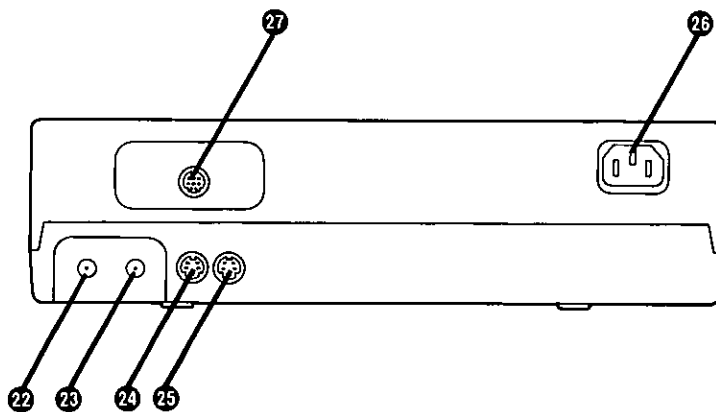

- 1 **[POWER] Button**
- 2 **[STAND BY] Lamp**
It remains lit as long as the Power Cable is connected to a wall socket.
- 3 **[POWER] Lamp**
It lights when you turn the power on.
- 4 **Print Exit**
The printed pictures are ejected here.
- 5 **Paper Cassette**
The printing paper is stacked here.
- 6 **Ink Cassette Compartment**
It holds the Ink Cassette.
- 7 **Ink Cassette Compartment Door**
Open this Door to insert or take out the Ink Cassette.
- 8 **[ERROR] Lamp**
It flashes when the paper is jammed or condensation has formed inside the Printer; at the same time, a corresponding error message appears on the TV screen.
- 9 **[PAPER/INK] Lamp**
It flashes when the Paper Cassette or the Ink Cassette is empty; at the same time a corresponding message appears on the TV screen.
- 10 **[S-VIDEO] Input Jack on the Front Panel**
Connect to video equipment with an S-Video Output Jack.
- 11 **[VIDEO] Input Jack on the Front Panel**
Connect to video equipment with a Video Output Jack.
- 12 **Print Exit Cover**
Open this Cover to take out the paper after printing.
- 13 **Ink Cassette Eject Lever**
Push it downward to eject the Ink Cassette.
- 14 **Ink Cassette Side Cover**
If paper is jammed, open this Cover to remove the stuck paper.
- 15 **[1SHOT ERASE]/[◀] Button**
 - Every single push of this Button in the Multi-Print Mode or in the Strobe Mode erases one picture after another.
 - In the Menu Mode or Multi-Print Mode, this button functions as [◀] Cursor Button.
- 16 **[MENU]/[▼] Button**
 - Pressing this Button puts the Printer in the Menu Mode.
 - In the Menu Mode, this button functions as [▼] Cursor Button.
- 17 **[MULTI]/[▶] Button**
 - Use this Button to print a series of different pictures, all on the same print.
 - In the Menu Mode or Multi-Print Mode, this button functions as [▶] Cursor Button.
- 18 **[FLD/FRM]/[EXEC] Button**
 - If the memorized picture is blurred, press this Button to set to [FLD]. If the memorized picture is not blurred, press this Button to set to [FRM].
 - In the Menu Mode and Multi-Print Mode, this button functions as [EXEC] Button.
- 19 **[MONITOR] Button**
Use this Button to switch over from the picture from the external video source unit to the memorized picture or vice versa.
- 20 **[MEMORY] Button/Lamp**
Press this Button while the [MEMORY] Lamp is lit. This stores the picture from the external video source unit in memory.
- 21 **[PRINT] Button**
Press this Button while the [PRINT] Lamp is lit. This prints the picture stored in memory.
- 22 **[VIDEO] Input Jack**
Connect to video equipment with a Video Output Jack.
- 23 **[VIDEO] Output Jack**
Connect to the Video Input Jack on the TV.
- 24 **[S-VIDEO] Input Jack**
Connect to video equipment with an S-Video Output Jack.
- 25 **[S-VIDEO] Output Jack**
Connect to the S-Video Input Jack on the TV.
- 26 **Power Socket**
Connect the Power Cable to an AC power outlet.
- 27 **[EXT.] Jack**
Connect the optional Foot Pedal (AG-A2P).

Connection

1 When Printing Pictures from a VCR etc. That Are Played Back on a TV Equipped with Video Input Jacks

- For safety reasons, turn off the power of all units before connecting.
- Select [VIDEO] or [S-VIDEO] for [INPUT] in the Menu Mode according to the type of video input jack to which the connection is made. (p. 16)
- When connecting to one of the Video Input Jacks on the Front Panel, selecting [VIDEO] or [S-VIDEO] for the connection on the Rear Panel is not possible, because the connection on the Front Panel has priority. To select the desired connection on the Rear Panel, disconnect the Video Cable from the Front Panel.

Connections ①, ② and ③ (Using 2 Video Cables)

Please purchase a suitable Video Cables for connections ② and ③, as these cables are not supplied.

<Hint>

When both the VCR and TV are equipped with S-Video Jacks,

Use connections ①, ④ and ⑤ (Using 2 S-Video Cables)

Please purchase suitable S-Video Cables for connections ④ and ⑤, as these cables are not supplied.

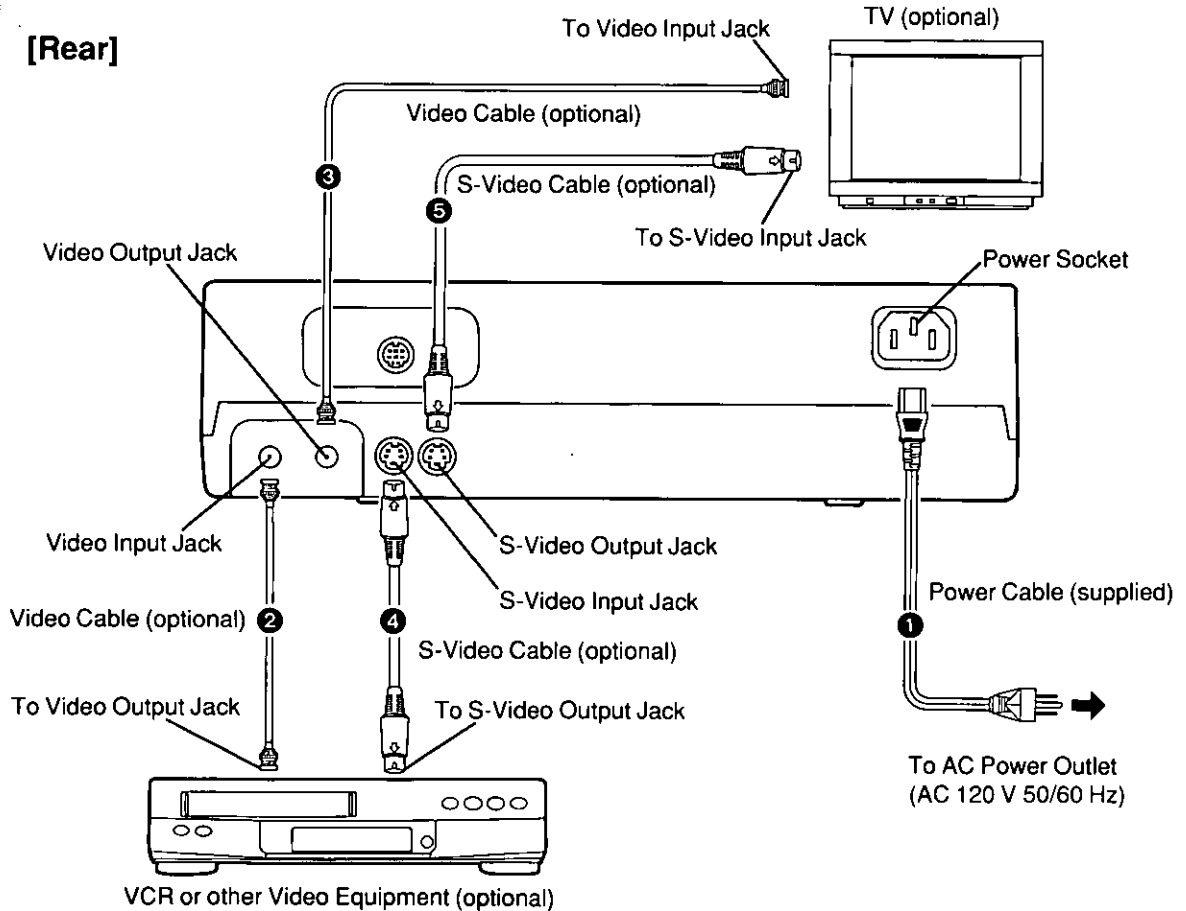

When the Color Video Printer's power is off, the picture signal input through the S-Video Input Jack is output only through the S-Video Output Jack, and the picture signal input through the Video Input Jack is output only through the Video Output Jack. In both cases, the corresponding Video Input Jack on the Front Panel has priority. The selection of the Input Jack made in the Menu Mode has no effect when the power is off.

2 When Printing Pictures from a Movie Camera

- In this case, connecting the Movie Camera to a Video Input Jack on the Front Panel is most convenient.
- Select [VIDEO] or [S-VIDEO] for [INPUT] in the Menu Mode according to the type of video input jack to which the connection is made. (p. 16)

Connections ①, ② and ③ (Using 2 Video Cables)

<Hint>

When the Movie Camera is equipped with S-Video Jacks, Use connections ①, ④ and ⑤ (Using 2 S-Video Cables)

[Front]

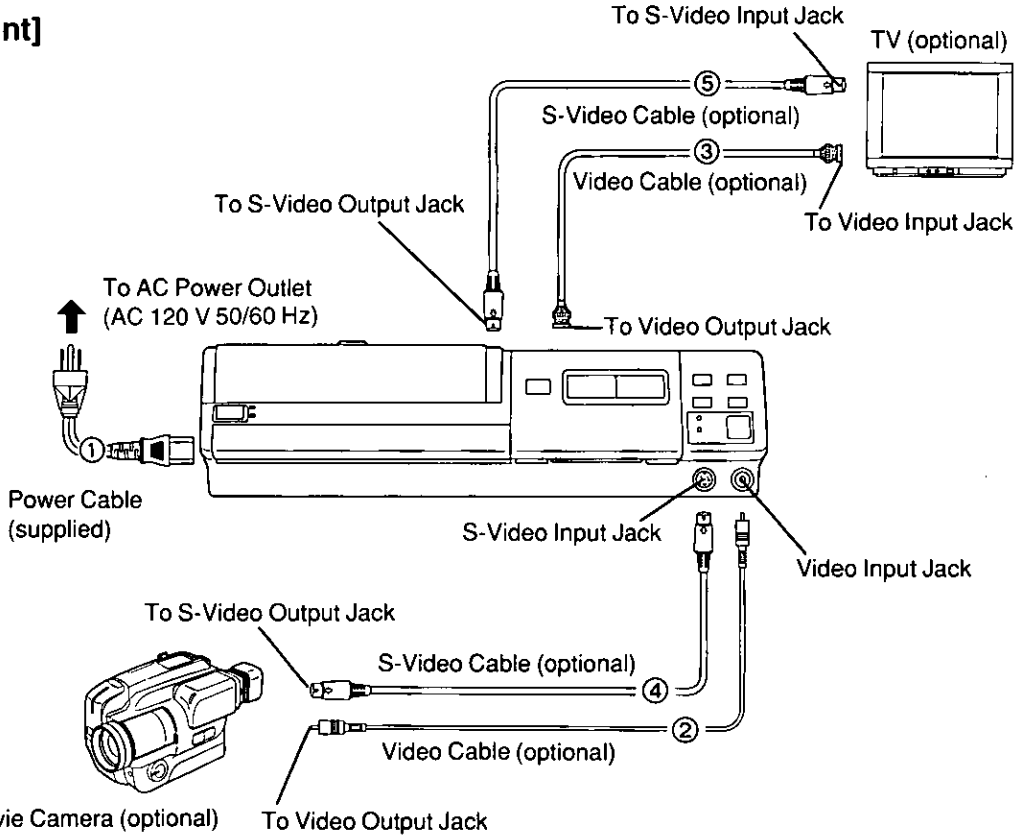

Note for the installation:

As this Printer employs the thermal sublimation transfer printing system, the temperature inside the unit rises considerably. Be sure to install it in a well-ventilated place.

3 When Performing Remote Control Operation from External Equipment

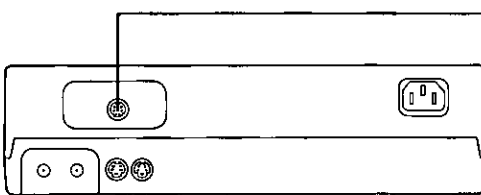

Remote Control Jack [EXT.]:
Connecting the optional Foot Pedal AG-A2P to this jack makes possible remote-controlled operation of the Printer.

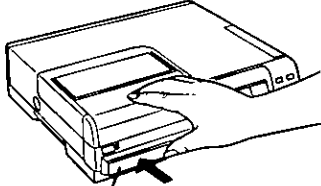
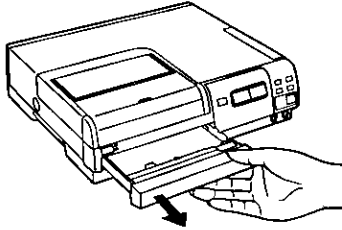
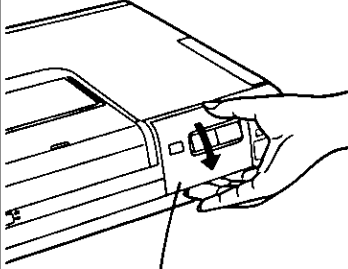
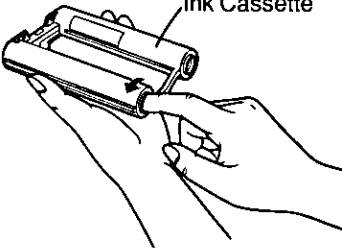
Title/Purpose	Operations	
<p>Inserting the Printing Paper</p>	<p>1 Push the Paper Cassette inward.</p>  <p>Paper Cassette</p> <ul style="list-style-type: none"> •When pushing and then releasing the Paper Cassette, it pops out. 	<p>2 Pull it out.</p> 
<p>Inserting the Ink Cassette</p>	<p>1 Open the Ink Cassette Compartment Door.</p>  <p>Ink Cassette Compartment Door</p>	<p>2 Tighten the Ink Film in the Ink Cassette.</p>  <p>Ink Cassette</p> <ul style="list-style-type: none"> •Insert a finger in the spool and turn in the direction of the arrow. •The Ink Cassette is part of the optional Video Print Set.

■ Removing the Ink Cassette

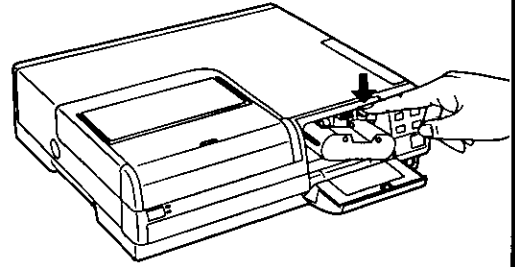

Push down the Ink Cassette Eject Lever and pull the Ink Cassette straight out.

Remarks, etc.

3 Insert the printing paper with its printed markings facing downward into the Paper Cassette.

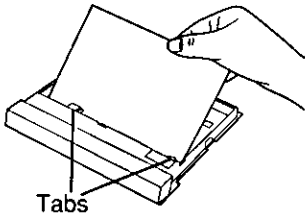

Tabs

- The cassette can hold up to 25 sheets of normal or adhesive paper.
- Insert the printing paper under the two tabs.

4 Insert the Paper Cassette completely.

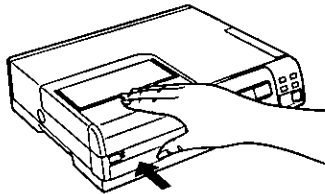

- Do not touch the printing (unmarked) side of the paper.
- Fan the paper before inserting it into the Paper Cassette, because several sheets sticking to each other could cause a paper jam.
- Do not bend or fold the paper or insert it with the wrong side facing upward. This could cause malfunction.
- During printing, the Paper Cassette cannot be removed.
- If the paper is curled and protrudes over the top edge of the Paper Cassette, remove some sheets of paper so that the paper fits properly into the Cassette.

3 Hold the Ink Cassette so that the recessed part faces upward and insert it completely.

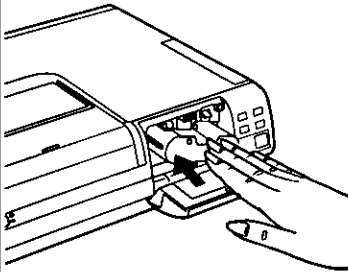



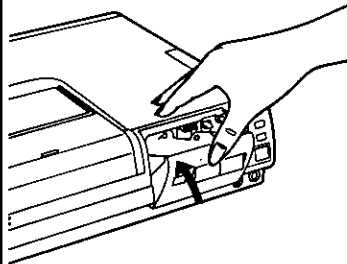



4 Close the Ink Cassette Compartment Door.

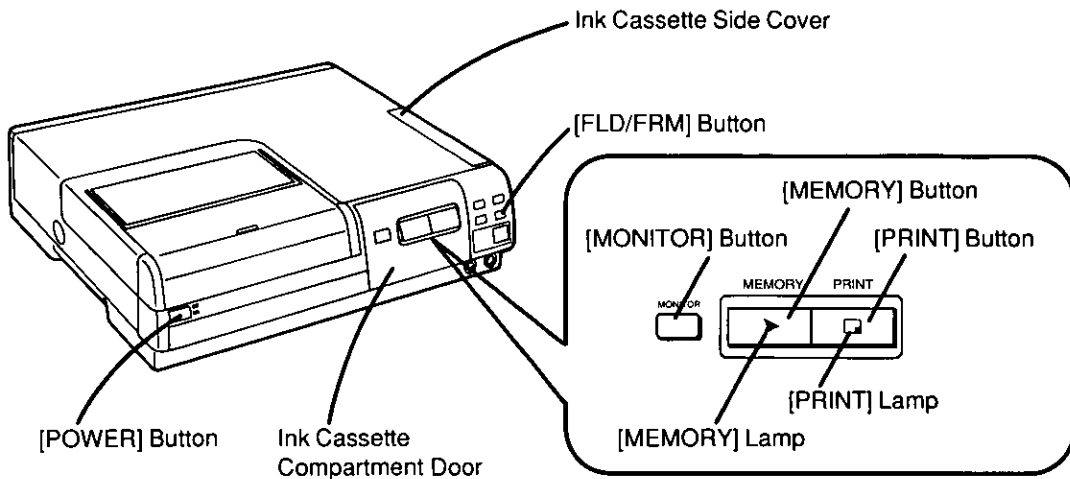

Confirm that the Cassette is completely inserted, before you close the door.

- Do not touch the Ink Film in the Ink Cassette or try to remove it from the cassette.
- When the Ink Film in the Ink Cassette is used up, replace it with a new Ink Cassette. The old Ink Cassette cannot be reused.
- Do not try to remove the label affixed to the Ink Cassette.
- To obtain good printing quality, use only the Printing Paper and the Ink Cassette packed together as a set in the same box.
- For removing the Ink Cassette from the Printer, refer to the illustration at the top of the page.



Title/Purpose	Operations	
<h2 data-bbox="104 605 446 651">Normal Printing</h2> <ul data-bbox="104 689 615 803" style="list-style-type: none"> • This section explains the basic operations for printing. • Before printing, connect the Printer with a VCR, Movie Camera or/and TV. 	<p data-bbox="647 605 938 643">1 Turn the Printer on.</p>  <ul data-bbox="647 986 951 1012" style="list-style-type: none"> • The [POWER] Lamp lights. 	<p data-bbox="1005 605 1314 738">2 Select the Video Input Jack (VIDEO or S-VIDEO) on the MENU Screen.</p>  <ul data-bbox="1005 986 1314 1070" style="list-style-type: none"> • For details about selecting, refer to "Selecting the Input Jack (INPUT)" on page 16.
<p data-bbox="647 1222 1306 1260">■ Selecting a Field Picture or Frame Picture</p> <p data-bbox="647 1260 1306 1309">Push the [FLD/FRM EXEC] Button to change the picture mode between the following two modes:</p> <ul data-bbox="661 1336 1306 1546" style="list-style-type: none">  FLD: For printing a picture with fast moving subjects and when the picture stored in memory is blurred. (This reduces blurring due to fast movement, however, the picture quality may be slightly inferior to that in the FRM Mode.)  FRM: For printing a still picture or a moving picture with little movement. 		

■ After Printing

Take out finished the prints as shown in the illustration below.

- To prevent paper jam, do not let more than 10 finished prints accumulate in the Print Exit.

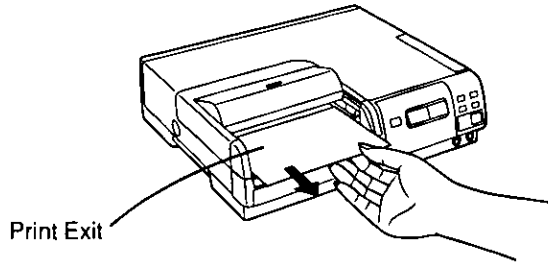

3 Press the [MEMORY] Button.

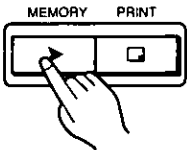

- The [PRINT] Lamp on the Printer lights.
- To replace the stored picture by a new one, press the [MONITOR] Button, and then press the [MEMORY] Button again.

4 Press the [PRINT] Button while the [PRINT] Lamp is lit.

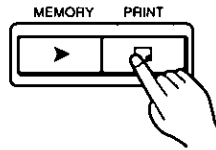

- Printing starts.
- When printing is finished, the picture from the source unit appears again on the TV screen.

Remarks, etc.

- The [1SHOT ERASE] Button and the [MEMORY] Button do not work during printing.
- Printing two or more pictures continuously or printing in low or high temperature may take more time.
- Do not try to take out the Paper Cassette and the Ink Cassette during printing. To do so would halt printing and could cause paper jam or a defect of the unit.
- Do not pull on the printing paper while it is still moving during printing. This could cause malfunction of the unit.
- If the Printer becomes hot, the edge of the printed pictures could become slightly discolored.

Hints for Use

- If you press the [MONITOR] Button during printing, the picture from the source unit appears again on the TV screen and you can search for the next picture to be printed.
- After printing is finished, you can print the same picture one more time simply by again pressing the [MONITOR] Button so that the stored picture appears on the TV screen, and then pressing the [PRINT] Button.
- During printing (when the selected number of prints is 2 or more), the following message appears:

[MENU] PRINT STOP

If you press the [MENU] Button, printing will stop after the printing of the present print is finished, and all further selected prints are canceled.

■ If the Paper Gets Jammed

- 1 Turn the power off and unplug the Power Cable from the wall outlet.
- 2 Open the Ink Cassette Compartment Door and remove the Ink Cassette.
- 3 Open the Ink Cassette Side Cover.
- 4 Pull out the paper from the Ink Cassette Compartment.

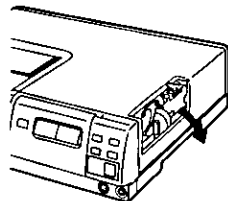

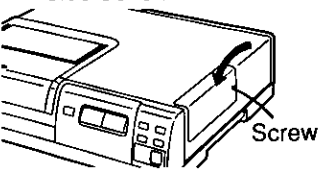

- Pull out the jammed paper from the Ink Cassette Compartment Door or from the opened Ink Cassette Side Cover.

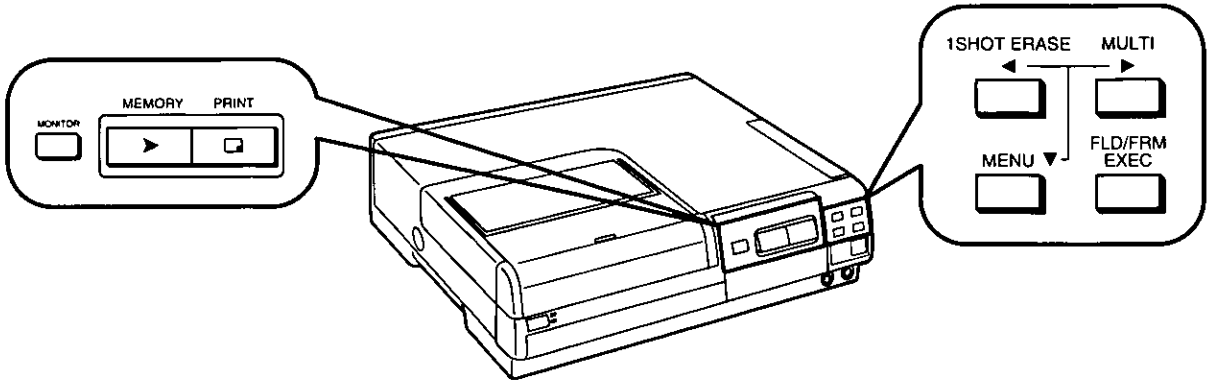

- Turn the screw counterclockwise with a screwdriver to open the Cover.

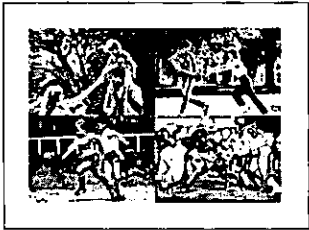
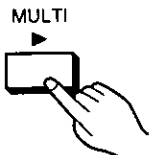
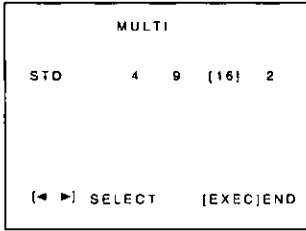
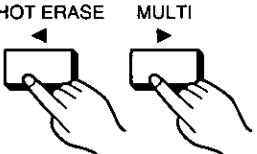
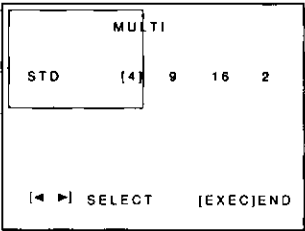
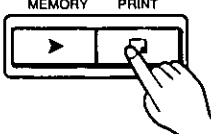

Title/Purpose	Operations	
<p>Printing a Series of Different Pictures on the Same Print (Multi Print)</p>  <p>This printing function allows you to divide the screen into 2, 4, 9 or 16 mini-frames, fill them with different pictures and print them together on the same print.</p>	<p>1 Press the [MULTI] Button.</p>  <ul style="list-style-type: none"> The screen is divided into a number of mini-frames. 	<p>2 Press the [◀] or the [▶] Button to select the desired number of mini-frames.</p>  
	<p>5 Press the [PRINT] Button.</p>  <ul style="list-style-type: none"> Printing starts. 	

3 Press the [EXEC] Button.

FLD/FRM
EXEC

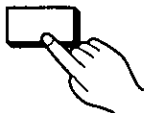

4 Press the [MEMORY] Button.

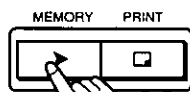

- Each press of this Button stores the picture currently displayed on the TV screen in a mini-frame.

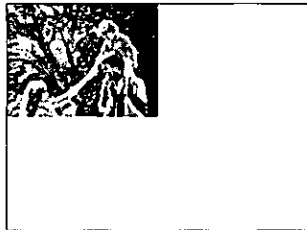

Remarks, etc.

- When [DIVIDE], [ZOOM] or [STROBE] has been selected for the [FORMAT] on the MENU Screen (p.18), the [MULTI] Button does not work.

■ To Cancel Stored Pictures

Press the [MONITOR] Button to display the stored pictures on the TV screen, and then press the [1SHOT ERASE] Button.

Every push of this Button erases one stored picture starting with the last one.

To store a new picture in place of an erased one, press the [MONITOR] Button again.

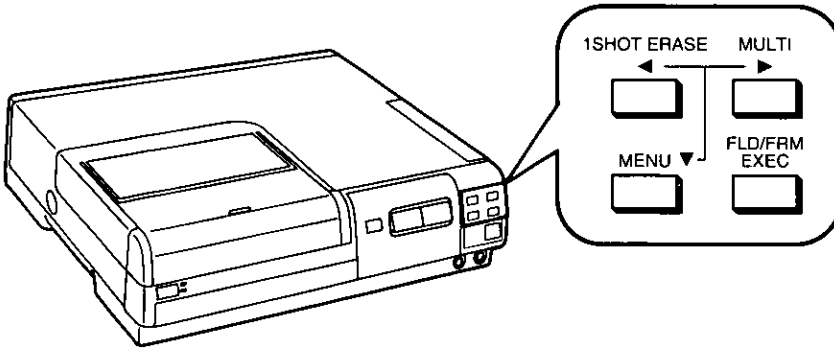

Title/Purpose

Operations

Using the Menu Mode

The Menu Mode can be used to display the MENU on the TV screen and to select functions as well as the Input Jack being used.

■ How to Use the Operation Buttons for the MENU Screen

When you press the [MENU] Button, the MENU Screen appears on the TV screen.

The following 4 buttons now function as Cursor buttons and Execution Button for selecting items on the MENU Screen.

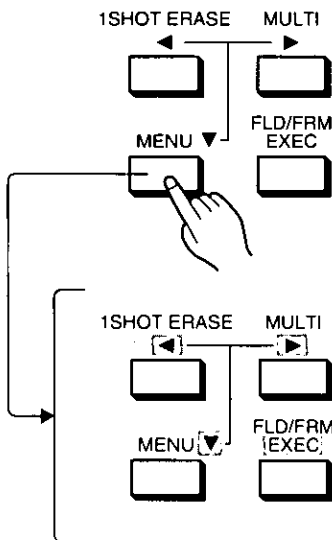

- In the Menu Mode, the functions of these 4 buttons are as indicated by the symbols in shaded boxes under the names of the buttons.

1 Press the [MENU] Button.

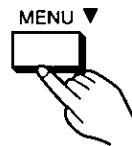

- The MENU Screen appears on the TV screen.

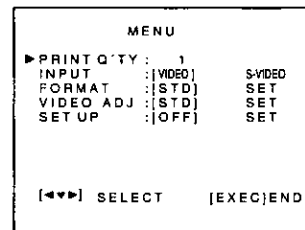

2 Press the [▼] Button to select the desired item.

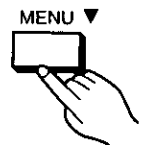

- The ► Cursor indicates the selected item.

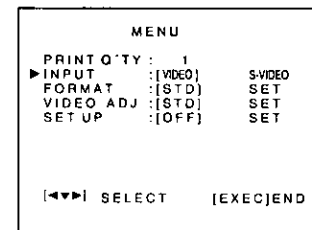

- 1 Print Quantity (PRINT Q'TY):** Select the desired number of prints (max. 10) with the [◀] or the [▶] Button.
- 2 Input Jack Selector (INPUT);** Select with the [◀] or the [▶] Button.
[VIDEO]: When connecting the video source unit to the Video Input Jack
[S-VIDEO]: When connecting the video source unit to the S-Video Input Jack
- 3 Format (FORMAT):** After selecting [SET], you can select one of five different printing modes with the [▼] Button.
- 4 Picture Quality (VIDEO ADJ):** After selecting [SET], you can adjust the picture quality.
- 5 Set-Up (SET UP):** When you select [SET], the SET UP Screen appears on the TV screen.

3 Press the [◀] or the [▶] Button to select the desired setting.

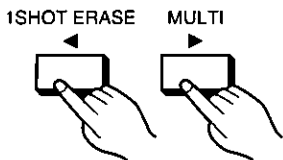

•The selected setting is indicated by [▶].

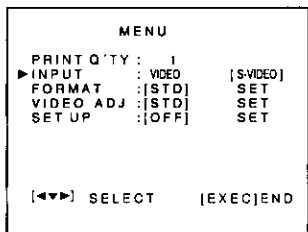

4 Press the [EXEC] Button to complete the setting.



•The MENU Screen disappears from the TV screen.

Remarks, etc.

- The [MENU] Button does not work during printing.
- While the MENU Screen is displayed on the TV screen, the [MEMORY], [PRINT] and [MONITOR] Buttons do not work.
- When you select a printing mode on the FORMAT Screen, the selected function is displayed for the item "FORMAT" on the MENU Screen instead of [STD].
- When you select a desired picture quality on the VIDEO ADJ Screen, [ADJ] is displayed for the item "VIDEO ADJ" on the MENU Screen instead of [STD]. The selected setting will be maintained until you select a different setting on the VIDEO ADJ Screen.
- The Cursor Buttons corresponding to the triangle marks shown at the bottom of the MENU Screen (◀▶) can be used.

MENU

- ① → PRINT Q'TY : 1
- ② → INPUT : [VIDEO] S-VIDEO
- ③ → FORMAT : [STD] SET
- ④ → VIDEO ADJ : [STD] SET
- ⑤ → SET UP : [OFF] SET

[◀▶] SELECT [EXEC]END

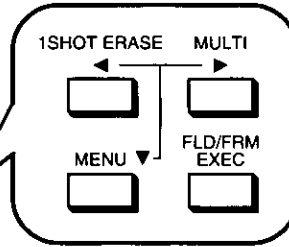
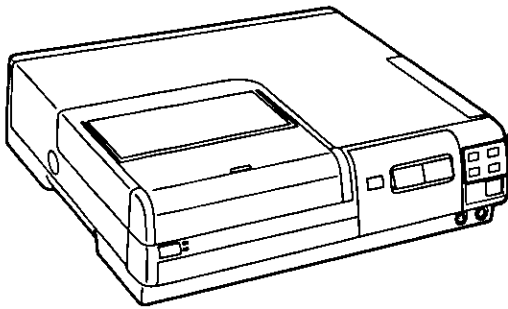

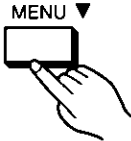
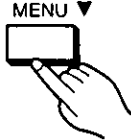
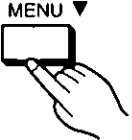
Title/Purpose	Operations	
<h3>Selecting the Number of Prints (PRINT Q'TY)</h3> <p>A maximum 10 prints can be selected for one printing cycle.</p>	<p>1 Press the [MENU] Button.</p>  <p>•The MENU Screen appears on the TV screen.</p> <pre> MENU ▶PRINT Q'TY : 1 INPUT :[VIDEO] S-VIDEO FORMAT :[STD] SET VIDEO ADJ :[STD] SET SET UP :[OFF] SET [◀▶] SELECT [EXEC]END </pre>	<p>2 Select [PRINT Q'TY].</p> <pre> MENU ▶PRINT Q'TY : 1 INPUT :[VIDEO] S-VIDEO FORMAT :[STD] SET VIDEO ADJ :[STD] SET SET UP :[OFF] SET [◀▶] SELECT [EXEC]END </pre>
<h3>Selecting the Input Jack (INPUT)</h3> <p>Perform these steps to select the Input Jack [VIDEO] or [S-VIDEO] to which the source unit is connected.</p>	<p>1 Press the [MENU] Button.</p>  <pre> MENU ▶PRINT Q'TY : 1 INPUT :[VIDEO] S-VIDEO FORMAT :[STD] SET VIDEO ADJ :[STD] SET SET UP :[OFF] SET [◀▶] SELECT [EXEC]END </pre>	<p>2 Press the [▼] Button to select [INPUT].</p>  <pre> MENU ▶PRINT Q'TY : 1 INPUT :[VIDEO] S-VIDEO ▶INPUT :[VIDEO] S-VIDEO FORMAT :[STD] SET VIDEO ADJ :[STD] SET SET UP :[OFF] SET [◀▶] SELECT [EXEC]END </pre>

3 Press the [◀] or the [▶] Button to select the number of prints desired.

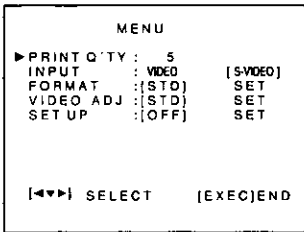
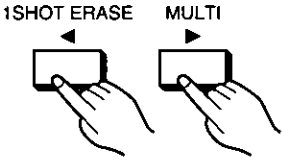

4 Press the [EXEC] Button.



• This terminates the Menu Mode.

Remarks, etc.

- The number of prints can be selected between 1 and 10.
- If the desired number of prints is set to 2 or more, the number is automatically reset to 1 when printing is finished.

3 Press the [◀] or the [▶] Button to select the Input Jack being used.

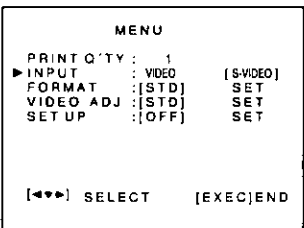
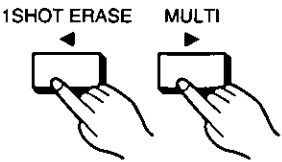

4 Press the [EXEC] Button.





• This terminates the Menu Mode.

■ Selecting the Input Jack

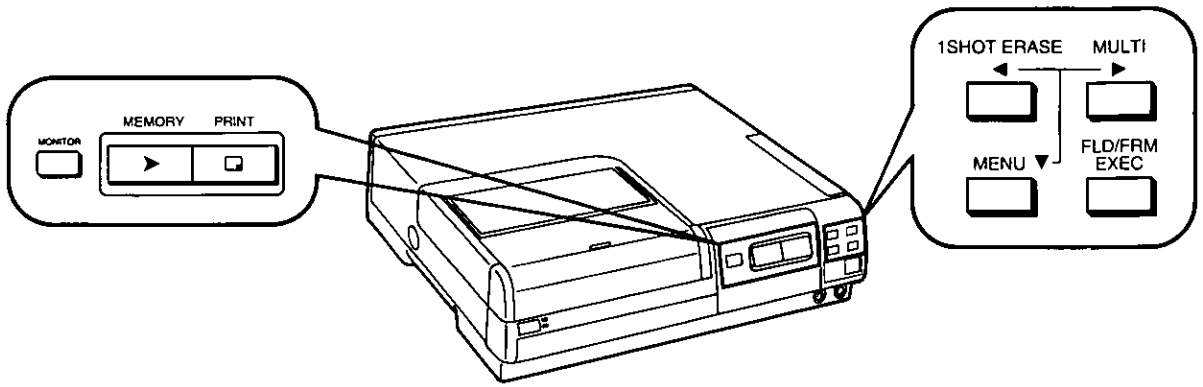
- Select [VIDEO] when the picture signal is input through the Video Input Jack, and select [S-VIDEO] when the picture signal is input through the S-Video Input Jack.
- If the Input Mode selected on the MENU Screen is different from the actually connected Input Jack, no picture is displayed.
- If connections are made to Input Jacks on both the Front and Rear Panels, the Input Jack on the Front Panel has priority. (The Input Jacks on the Front Panel are also selected with the setting made on the MENU Screen.)

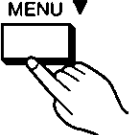
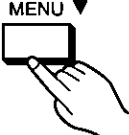

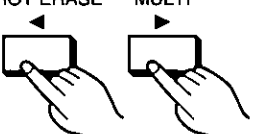
Title/Purpose	Operations	
<h3>Selecting the Printing Format (FORMAT)</h3> <p>You can select from among several printing modes.</p> <p>STD: For normal printing</p> <p>MULTI: For printing a sequence of different pictures on the same print</p> <p>DIVIDE: For printing the same picture on the same print</p> <p>ZOOM: For printing an enlarged part of a picture</p> <p>STROBE: For printing a sequence of pictures taken at intervals from a scene on the same print</p>	<p>1 Press the [MENU] Button.</p>  <div data-bbox="642 955 947 1184"> <p style="text-align: center;">MENU</p> <p>▶ PRINT Q'TY : 1</p> <p>INPUT : [VIDEO] S-VIDEO</p> <p>FORMAT : [STD] SET</p> <p>VIDEO ADJ : [STD] SET</p> <p>SET UP : [OFF] SET</p> <p>[◀▶] SELECT [EXEC]END</p> </div>	<p>2 Press the [▼] Button to set the ▶ Cursor to [FORMAT].</p>  <div data-bbox="1018 955 1323 1184"> <p style="text-align: center;">MENU</p> <p>PRINT Q'TY : 1</p> <p>INPUT : [VIDEO] S-VIDEO</p> <p>▶ FORMAT : [STD] SET</p> <p>VIDEO ADJ : [STD] SET</p> <p>SET UP : [OFF] SET</p> <p>[◀▶] SELECT [EXEC]END</p> </div>
<p>1 Printing a Sequence of Different Pictures on the Same Print (MULTI)</p> 	<p>1 Press the [▼] Button to select [MULTI] on the FORMAT Screen.</p>  <div data-bbox="642 1570 947 1799"> <p style="text-align: center;">FORMAT</p> <p>STD</p> <p>▶ MULTI : [4] 9 16 2</p> <p>DIVIDE</p> <p>ZOOM</p> <p>STROBE</p> <p>[◀▶] SELECT [EXEC]END</p> </div>	<p>2 Press the [◀] or the [▶] Button to select the desired number of mini-frames.</p>  <div data-bbox="1018 1570 1323 1799"> <p style="text-align: center;">FORMAT</p> <p>STD</p> <p>▶ MULTI : 4 9 [16] 2</p> <p>DIVIDE</p> <p>ZOOM</p> <p>STROBE</p> <p>[◀▶] SELECT [EXEC]END</p> </div>

3 Press the [▶] Button to select [SET].

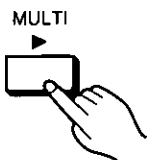

•The FORMAT Screen appears on the TV screen.

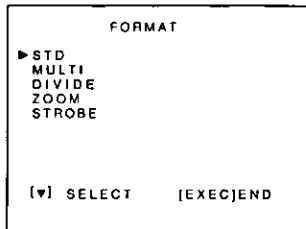

■ To display the picture from the source unit again, press the [EXEC] Button.



•This terminates the Menu Mode.

Remarks, etc.

•When you select a printing mode on the FORMAT Screen and return to the MENU Screen, the selected function is displayed there.

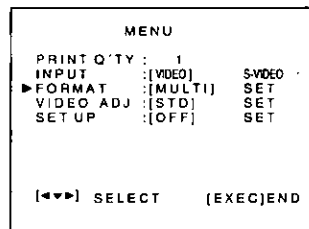

Example of the [FORMAT] Screen after changing the setting from [STD] to [MULTI].

3 Press the [EXEC] Button.



•This terminates the Menu Mode.

4 Press the [MEMORY] Button.

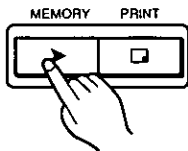

•Each press of this button stores the currently displayed picture in a mini-frame starting at the upper-left corner.







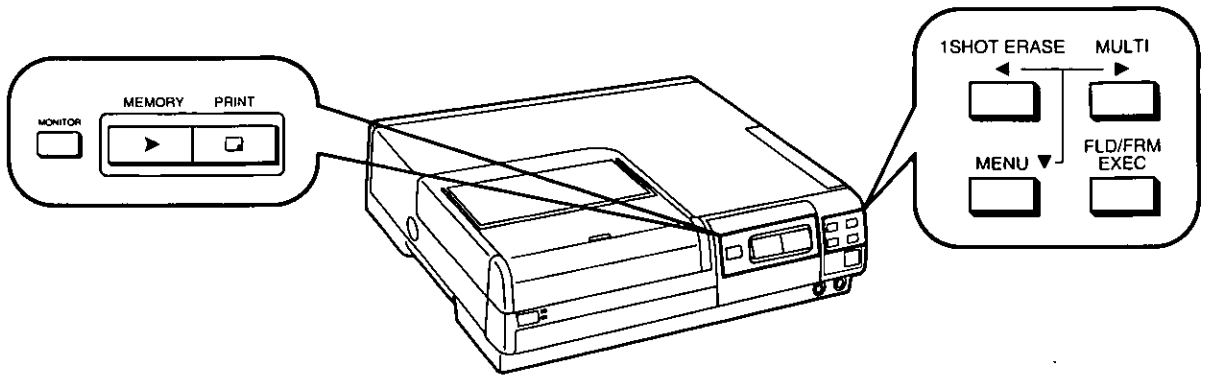

■ To Print the Multi-Picture Sequence

When all mini-frames have been filled with pictures, the [PRINT] Lamp lights. To start printing, press the [PRINT] Button.

■ To Cancel Stored Pictures

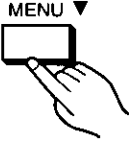
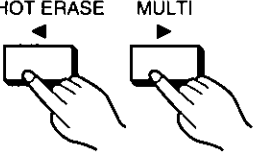
Press the [MONITOR] Button to display the stored pictures, and then press the [1SHOT ERASE] Button to erase them. Every push of this Button erases one stored picture starting with the last one. To store a new picture in place of an erased one, press the [MONITOR] Button again.

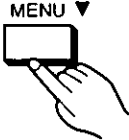

Title/Purpose	Operations																																											
<p>2 Printing the Same Picture Repeatedly on the Same Print (DIVIDE)</p> 	<p>1 Press the [▼] Button to set the ► Cursor to [DIVIDE] on the FORMAT Screen.</p>  <table border="1" data-bbox="646 957 951 1186"> <thead> <tr> <th colspan="3">FORMAT</th> </tr> </thead> <tbody> <tr> <td>STD</td> <td></td> <td></td> </tr> <tr> <td>MULTI</td> <td></td> <td></td> </tr> <tr> <td>► DIVIDE : [4]</td> <td>9</td> <td>16</td> </tr> <tr> <td>ZOOM</td> <td></td> <td></td> </tr> <tr> <td>STROBE</td> <td></td> <td></td> </tr> <tr> <td>[◀▶] SELECT</td> <td></td> <td>[EXEC]END</td> </tr> </tbody> </table>	FORMAT			STD			MULTI			► DIVIDE : [4]	9	16	ZOOM			STROBE			[◀▶] SELECT		[EXEC]END	<p>2 Press the [◀] or the [▶] Button to select the desired number.</p>  <table border="1" data-bbox="1026 957 1331 1186"> <thead> <tr> <th colspan="3">FORMAT</th> </tr> </thead> <tbody> <tr> <td>STD</td> <td></td> <td></td> </tr> <tr> <td>MULTI</td> <td></td> <td></td> </tr> <tr> <td>► DIVIDE : 4</td> <td>9</td> <td>[16]</td> </tr> <tr> <td>ZOOM</td> <td></td> <td></td> </tr> <tr> <td>STROBE</td> <td></td> <td></td> </tr> <tr> <td>[◀▶] SELECT</td> <td></td> <td>[EXEC]END</td> </tr> </tbody> </table>	FORMAT			STD			MULTI			► DIVIDE : 4	9	[16]	ZOOM			STROBE			[◀▶] SELECT		[EXEC]END
FORMAT																																												
STD																																												
MULTI																																												
► DIVIDE : [4]	9	16																																										
ZOOM																																												
STROBE																																												
[◀▶] SELECT		[EXEC]END																																										
FORMAT																																												
STD																																												
MULTI																																												
► DIVIDE : 4	9	[16]																																										
ZOOM																																												
STROBE																																												
[◀▶] SELECT		[EXEC]END																																										
<p>3 Printing an Enlarged Part of the Picture (ZOOM)</p> 	<p>1 Press the [▼] Button to set the ► Cursor to [ZOOM] on the FORMAT Screen.</p>  <table border="1" data-bbox="646 1572 951 1801"> <thead> <tr> <th colspan="3">FORMAT</th> </tr> </thead> <tbody> <tr> <td>STD</td> <td></td> <td></td> </tr> <tr> <td>MULTI</td> <td></td> <td></td> </tr> <tr> <td>DIVIDE</td> <td></td> <td></td> </tr> <tr> <td>► ZOOM</td> <td></td> <td></td> </tr> <tr> <td>STROBE</td> <td></td> <td></td> </tr> <tr> <td>[▼] SELECT</td> <td></td> <td>[EXEC]END</td> </tr> </tbody> </table>	FORMAT			STD			MULTI			DIVIDE			► ZOOM			STROBE			[▼] SELECT		[EXEC]END	<p>2 Press the [EXEC] Button.</p>  <ul style="list-style-type: none"> • This terminates the Menu Mode. 																					
FORMAT																																												
STD																																												
MULTI																																												
DIVIDE																																												
► ZOOM																																												
STROBE																																												
[▼] SELECT		[EXEC]END																																										

Remarks, etc.

3 Press the [EXEC] Button.

FLD/FRM
EXEC



- This terminates the Menu Mode.

4 Press the [MEMORY] Button.

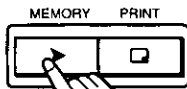

5 Press the [PRINT] Button.

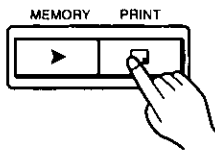

- Printing starts.

- It is also possible to select the number of mini-frames for [DIVIDE] in the Menu Mode after storing the picture you want to print.

3 Press the [MEMORY] Button.

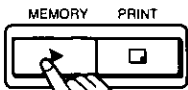

- The center part of the picture is enlarged to approx. twice its size for printing.
- When using the Infrared Remote (optional), the enlarged part of the stored picture can be moved in any of the 4 directions.

4 Press the [PRINT] Button.

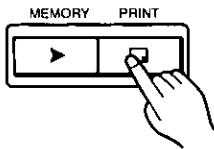

- Printing starts.

- Enlarging the original picture may cause the resulting print to become somewhat grainy.
- It is also possible to select [ZOOM] in the Menu Mode after storing the picture you want to print.
- The ZOOM Function lets you make an enlarged print of each quarter of the stored picture, so you can assemble the prints for a blow-up of the original picture.

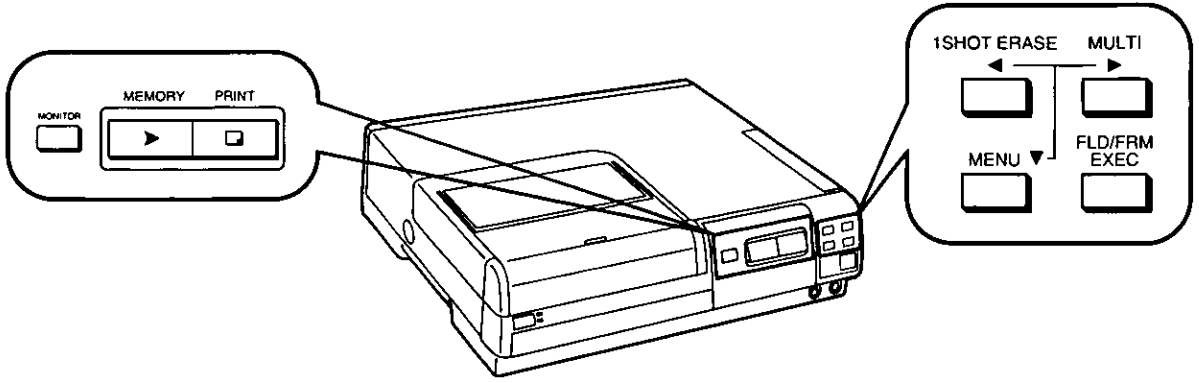

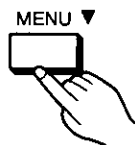
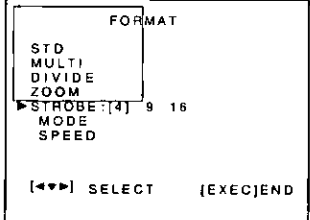
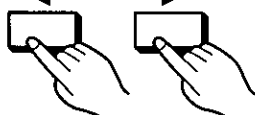
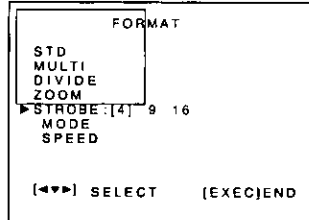
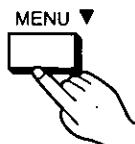
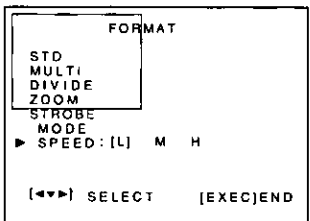
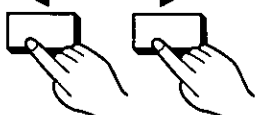
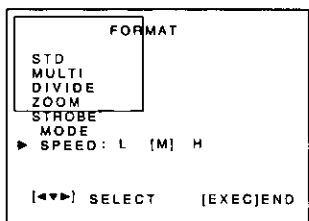
Title/Purpose	Operations	
<p>4 Printing a Sequence of Pictures Taken at Fixed Intervals on the Same Print (STROBE)</p>  <p>This printing function allows the screen to be divided into 4, 9 or 16 mini-frames, which you can then fill sequentially with freeze-frames taken at fixed intervals.</p>	<p>1 Press the [▼] Button to set the ► Cursor to [STROBE] on the FORMAT Screen.</p>  	<p>2 Press the [◀] or the [▶] Button to select the desired number.</p>  
	<p>5 Press the [▼] Button to set the ► Cursor to [SPEED].</p>  	<p>6 Press the [◀] or the [▶] Button to select the desired strobe speed.</p>  

3 Press the [▼] Button to set the ► Cursor to [MODE].

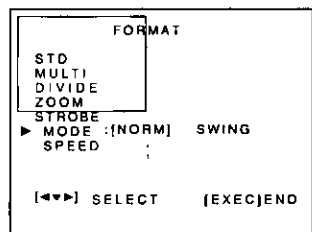

4 Press the [◀] or the [▶] Button to select the desired mode.

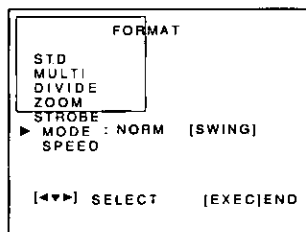
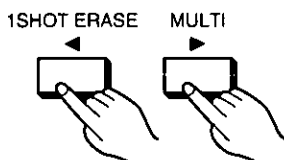

7 Press the [EXEC] Button.



• This terminates the Menu Mode.

8 Press the [MEMORY] Button.

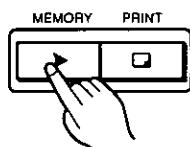

• This stores the strobe sequence of pictures in memory.



Remarks, etc.

■ To Erase Stored Pictures

- You can erase unwanted pictures in the sequence by pressing the [1SHOT ERASE] Button. Every push of this Button erases one stored picture starting with the last one.
- If you want to store a different strobe sequence of pictures, after having stored a sequence already, press the [MONITOR] Button to display the picture from the source unit and then press the [MEMORY] Button to store the new sequence.

Hint for Use

If you press the [MONITOR] Button after printing, the stored sequence of pictures reappears on the TV screen and can be printed again. (However, it is no longer possible to change pictures of the sequence by using the [1SHOT ERASE] Button.)

■ Notes about the Strobe Mode

- [NORM]: The pictures are taken and stored in memory at uniform intervals.
- [SWING]: The intervals become shorter towards the middle of the sampling period and then become longer again towards the end of it. This mode is ideal for motion analysis prints of golf swings, tennis serves, etc.

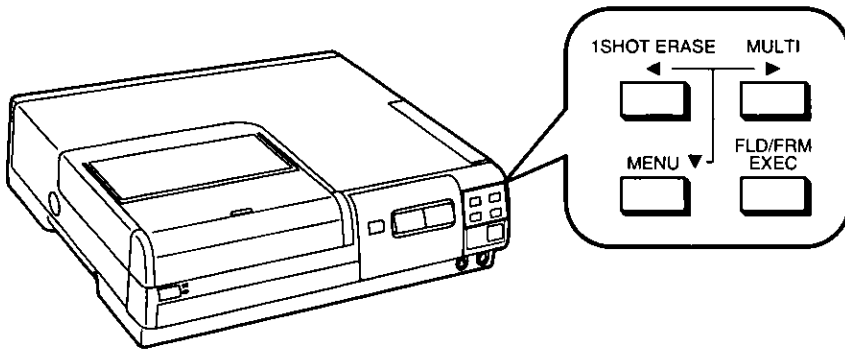

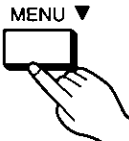
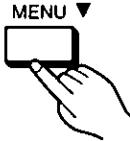
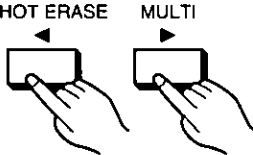
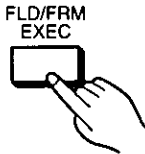
Title/Purpose	Operations	
<h2 data-bbox="111 614 581 768">Adjusting the Picture Quality (VIDEO ADJ)</h2> <p data-bbox="111 875 620 933">For optimum printing results, it is recommended to adjust the quality of the stored picture.</p>	<p data-bbox="666 614 937 687">1 Press the [MENU] Button.</p>  <ul data-bbox="666 896 930 954" style="list-style-type: none"> •The MENU Screen appears on the screen. <div data-bbox="666 967 971 1199"> <pre> MENU ▶PRINT Q'TY : 1 INPUT :[VIDEO] S-VIDEO FORMAT :[STD] SET VIDEO ADJ :[STD] SET SET UP :[OFF] SET [◀▶] SELECT [EXEC]END </pre> </div>	<p data-bbox="1044 614 1359 720">2 Press the [▼] Button to set the ► Cursor to [VIDEO ADJ].</p>  <div data-bbox="1044 967 1348 1199"> <pre> MENU PRINT Q'TY : 1 INPUT :[VIDEO] S-VIDEO FORMAT :[STD] SET ▶VIDEO ADJ :[STD] SET SET UP :[OFF] SET [◀▶] SELECT [EXEC]END </pre> </div>
	<p data-bbox="666 1238 971 1338">5 Press the [◀] or the [▶] Button to adjust as desired.</p>  <div data-bbox="666 1586 971 1818"> <pre> VIDEO ADJ STD ▶COLOR 0 -[-----]--+ TINT 0 BRIGHT 0 SHARPNESS: L [M] H [◀▶] SELECT [EXEC]END </pre> </div>	<p data-bbox="1044 1238 1359 1338">6 After the adjustment, press the [EXEC] Button.</p>  <div data-bbox="1044 1586 1348 1818"> <pre> VIDEO ADJ STD ▶COLOR 4 -[-----]--+ TINT 0 BRIGHT 0 SHARPNESS: L [M] H [◀▶] SELECT [EXEC]END </pre> </div>

■ To Achieve Optimum Picture Quality

- 1 Select [STD] for [VIDEO ADJ] on the MENU Screen and print a colorful picture that contains both bright and dark parts.
- 2 Use the picture controls on the TV set to adjust the colors on the screen so that they match the colors of the trial picture printed in step 1.
- 3 Adjust the picture quality items on the [VIDEO ADJ] Screen to obtain the desired picture quality.

- 3** Press the [▶] Button to select [SET].

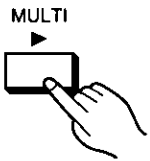

- The VIDEO ADJ Screen appears on the screen.

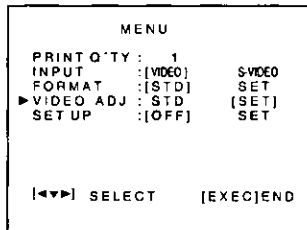

- 4** Press the [▼] Button to select the picture quality item that you want to adjust.

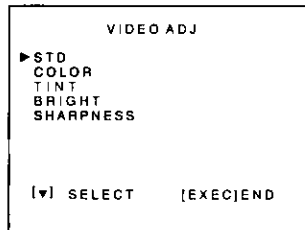
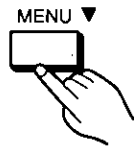

Remarks, etc.

■ Picture Quality Adjustment Items

[STD]: Standard setting of the picture quality. In this setting, adjusting the picture quality is NOT possible.

[COLOR]: This lets you adjust to the desired color intensity. Adjustment is possible between -9 and +9. (When set to -9, the printed picture is in black and white.)

[TINT]: This lets you adjust to the desired color tint. Adjustment is possible between -9 and +9. Adjusting to the right produces a greenish picture; adjusting to the left produces a reddish picture.





[BRIGHT]: This lets you adjust to the desired balance of brightness and depth. Adjustment is possible between -9 and +9.

[SHARPNESS]: This lets you adjust the picture contours.

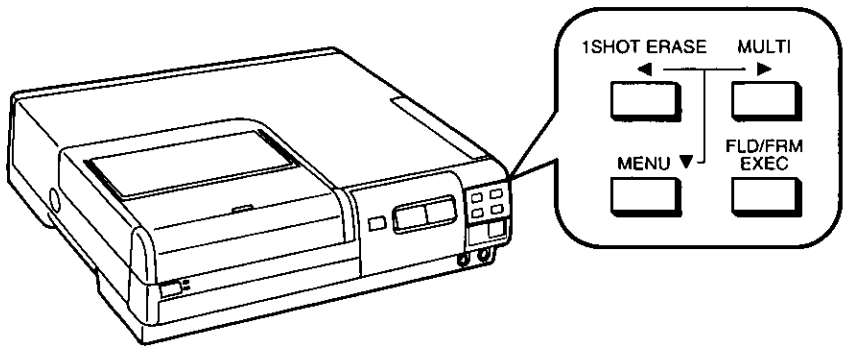
L; For soft picture contours
M; For normal picture contours
H; For sharp picture contours

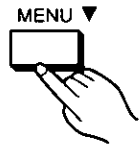
- Changing the setting of [SHARPNESS] does not change the appearance of the picture on the TV screen. Use a printed picture to judge and adjust the setting.

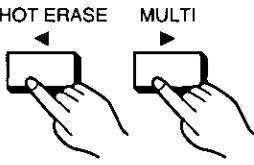

Title/Purpose	Operations	
<h2 data-bbox="109 618 521 772">Setting Up Special Functions (SET UP)</h2> <p data-bbox="109 879 473 908">The following items can be set up:</p> <ul data-bbox="109 911 624 1052" style="list-style-type: none"> • Selecting ON or OFF for Mirror Reverse Printing • Selecting ON or OFF for the grid lines on multi-prints • Selecting On or OFF for the On-Screen Display 	<p data-bbox="665 627 939 695">1 Press the [MENU] Button.</p>  <p data-bbox="665 898 967 956">• The MENU Screen appears on the TV screen.</p> <div data-bbox="665 975 967 1207"> <p style="text-align: center;">MENU</p> <pre> ▶ PRINT Q'TY : 1 INPUT : [VIDEO] S-VIDEO FORMAT : [STD] SET VIDEO ADJ : [STD] SET SET UP : [OFF] SET </pre> <p style="text-align: center;">[◀▶] SELECT [EXEC]END</p> </div>	<p data-bbox="1042 627 1351 724">2 Press the [▼] Button to set the ▶ Cursor to [SET UP].</p>  <div data-bbox="1042 975 1351 1207"> <p style="text-align: center;">MENU</p> <pre> PRINT Q'TY : 1 INPUT : [VIDEO] S-VIDEO FORMAT : [STD] SET VIDEO ADJ : [STD] SET ▶ SET UP : [OFF] SET </pre> <p style="text-align: center;">[◀▶] SELECT [EXEC]END</p> </div>
	<p data-bbox="665 1246 967 1342">5 Press the [◀] or the [▶] Button to select [ON] or [OFF].</p>  <div data-bbox="665 1593 967 1825"> <p style="text-align: center;">SET UP</p> <pre> ▶ MIRROR REV : OFF (ON) GRID LINE : [OFF] ON OSD : [OFF] ON EXT REMOTE : [A] B C D </pre> <p style="text-align: center;">[◀▶] SELECT [EXEC]END</p> </div>	<p data-bbox="1042 1246 1337 1342">6 After setting up is finished, press the [EXEC] Button.</p> 

3 Press the [▶] Button to select [SET].

MULTI



•The SET UP Screen appears on the TV screen.

MENU	
PRINT Q'TY :	1
INPUT :	[VIDEO] S-VIDEO
FORMAT :	[STD] SET
VIDEO ADJ :	[STD] SET
▶SET UP :	OFF (SET)
[◀▶] SELECT [EXEC]END	

4 Press the [▼] Button to select the item that you want to set up.

MENU.▼



SET UP	
▶MIRROR REV :	[OFF] ON
GRID LINE :	[OFF] ON
OSD :	[OFF] ON
EXT REMOTE :	[A] B C D
[◀▶] SELECT [EXEC]END	

Remarks, etc.

■ Set-Up Items

[MIRROR REV]: When set to [ON], the stored picture is printed image reversed (like a picture reflected in a mirror). However, the picture on the screen is not reversed.

[GRID LINE]: When set to [ON], the mini-frames of the print made in the Multi-Print Mode are separated by grid lines. However, the grid lines are not displayed on the screen.

[OSD]: When set to [OFF], the On-Screen Indications are canceled.

[EXT REMOTE]: When the optional Foot Pedal (AG-A2P) is connected, any of the four operation mode settings can be selected.

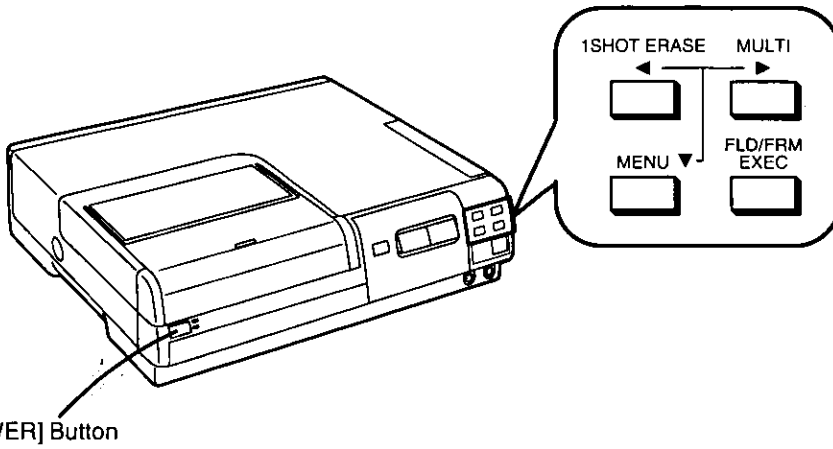

[POWER] Button

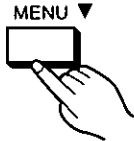
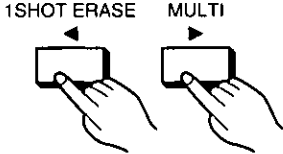
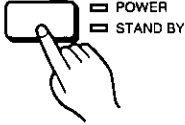
Title/Purpose	Operations	
<p>Selecting the Operation Mode of the External Remote Controller (EXT REMOTE)</p> <p>With these operation steps, you can select the operation mode for the optional Foot Pedal.</p>	<p>1 Press the (▼) Button to set the cursor to [EXT REMOTE] on the SET UP Screen.</p>  <div data-bbox="648 953 950 1182" style="border: 1px solid black; padding: 5px;"> <p style="text-align: center;">SET UP</p> <p>MIRROR REV : OFF [ON] WHITE BAR : [OFF] ON OSD : [OFF] ON ▶EXT REMOTE : [A] B C D</p> <p style="text-align: center;">[◀▶] SELECT [EXEC]END</p> </div>	<p>2 Press the (◀) or (▶) Button to select the desired remote operation mode.</p>  <div data-bbox="1033 953 1334 1182" style="border: 1px solid black; padding: 5px;"> <p style="text-align: center;">SET UP</p> <p>MIRROR REV : OFF [ON] WHITE BAR : [OFF] ON OSD : [OFF] ON ▶EXT REMOTE : A [B] C D</p> <p style="text-align: center;">[◀▶] SELECT [EXEC]END</p> </div>
<p>■ Using the External Remote Controller</p> <p>The optional Foot Pedal makes it possible to store and print pictures with simple foot operation.</p>	<p>1 Connect the Foot Pedal to the [EXT.] Jack on the Printer's rear panel.</p>	<p>2 Turn on the power.</p> 

■ Possible Operation Modes

Depending on the operation mode selected for the Foot Pedal, the functions of its [MEMORY/1SHOT ERASE] Pedal and [PRINT/MULTI] Pedal are different.

Normal Printing

	[A]	[B]	[C]	[D]
Storing in Memory	Push [MEMORY/1SHOT ERASE] Pedal.	Push [MEMORY/1SHOT ERASE] Pedal.	Push [MEMORY/1SHOT ERASE] Pedal.	Push [MEMORY/1SHOT ERASE] Pedal.
Returning to Picture from External Source	—	Push [MEMORY/1SHOT ERASE] Pedal for more than one second.	Push [MEMORY/1SHOT ERASE] Pedal for more than one second.	Push [MEMORY/1SHOT ERASE] Pedal for more than one second.
Printing	Push [PRINT/MULTI] Pedal.	Push [PRINT/MULTI] Pedal.	Push [MEMORY/1SHOT ERASE] Pedal.	Push [MEMORY/1SHOT ERASE] Pedal.

Multi-Printing

	[A]	[B]	[C]	[D]
Changing the Number of Mini-frames	—	Push [PRINT/MULTI] Pedal while picture from external source is displayed but not yet stored in memory.	—	—
Storing in Memory	Push [MEMORY/1SHOT ERASE] Pedal.	Push [MEMORY/1SHOT ERASE] Pedal.	Push [MEMORY/1SHOT ERASE] Pedal.	Push [MEMORY/1SHOT ERASE] Pedal.
Returning to Picture from External Source	Returns automatically.	Push [MEMORY/1SHOT ERASE] Pedal.	Push [MEMORY/1SHOT ERASE] Pedal.	Push [MEMORY/1SHOT ERASE] Pedal. (Returns automatically when Storing in Memory)
Storing Next Picture in Memory	Push [MEMORY/1SHOT ERASE] Pedal.	Push [MEMORY/1SHOT ERASE] Pedal.	Push [MEMORY/1SHOT ERASE] Pedal.	Push [MEMORY/1SHOT ERASE] Pedal.
Returning to Memory Picture	—	—	—	Push [MEMORY/1SHOT ERASE] Pedal for more than one second.
Erasing Stored Picture from Memory	—	Push [MEMORY/1SHOT ERASE] Pedal for more than one second.	Push [MEMORY/1SHOT ERASE] Pedal for more than one second.	Push [MEMORY/1SHOT ERASE] Pedal for more than one second.
Printing	Push [PRINT/MULTI] Pedal.	Push [PRINT/MULTI] Pedal.	Push [MEMORY/1SHOT ERASE] Pedal after storing picture in memory is completed.	Push [MEMORY/1SHOT ERASE] Pedal after storing picture in memory is completed.

3 After set-up is finished, press the [EXEC] Button.

FLD/FRM
EXEC



3 Operate the Foot Pedal.

- The function of the [MEMORY/1SHOT ERASE] and [PRINT/MULTI] Pedals differs depending on the setting described on the right.

Remote Control Operation from External Equipment

Remote-controlled operation is possible by controlling the TTL level of the [EXT.] Jack or with a mechanical switch. For more details, contact your Panasonic dealer or Panasonic directly.

Pin No.	Function	In/Out	Explanation of Function
1	GND	—	GROUND
2	MEMORY	In	Memory
3	PRINT	In	Print
4	BUSY	Out	Busy information of the Printer
5	+5 V	Out	Output of +5 V (Output resistance: 220Ω)
6	ERROR	Out	Error indication
7	OSD OFF	In	Turns the OSD off
8	—	—	—

Pin No.

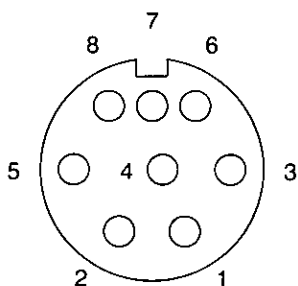

Input/Output Timing

Name of Pin

MEMORY
PRINT

OPEN

GND

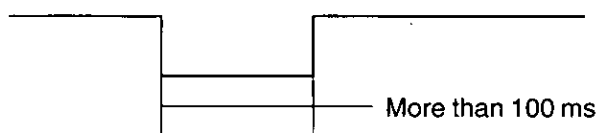

MEMORY ON
PRINT ON

OSD OFF

OPEN

GND

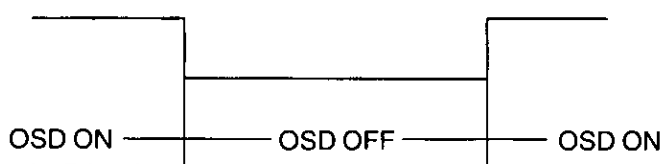

(When OSD is set to "ON" on the Printer's Menu Screen)

BUSY
ERROR

+5 V

0 V

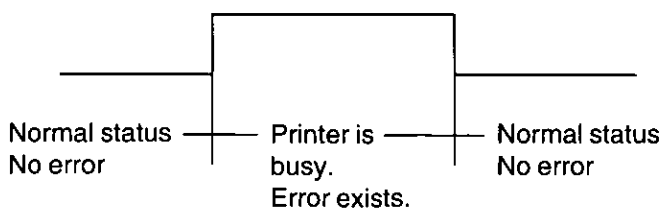

Precautions for Safety

(Be sure to read this chapter completely.)

- Please read the following explanations carefully before using this Color Video Printer to ensure correct and safe operation.
- Keep these instructions handy for later reference, in case you want to look up something in the future.

Placement

- Place the Printer on a stable, horizontal surface. Do not place any heavy object on it, because it could unbalance the Printer and cause it to drop. This could result in damage to the Printer and serious injury to persons. If the Printer has dropped, turn off the power and unplug the Power Cable, then contact your dealer. Continuing to use it in damaged condition is dangerous as it poses the risk of fire or electric shock.
- Do not step on the Printer. Especially, pay close attention that children do not step on the unit and damage it.
- Keep water and other liquids away from the Printer. Never place a filled flower vase or drinking glasses on it. If liquids are spilled into the Printer, it could cause a fire or electric shock. If some liquid has spilled into the Printer, turn off the power and unplug the Power Cable, then contact your dealer. Continuing to use it in that condition is dangerous as it poses the risk of fire or electric shock.
- Do not place small metal objects or flammable material on the Printer. Also, do not insert any metal object or flammable material through the ventilation holes or into the Ink Cassette Compartment. Especially, pay close attention to this where the Printer is in reach of little children. Inserting an object into the unit could cause a fire or electric shock. If an object is inserted in the unit, turn off the power and unplug the Power Cable, then contact your dealer. Continuing to use it with the object inside is dangerous and could cause a fire or electric shock.
- Do not obstruct the ventilation holes (located on the top, left, right and rear side of the unit) with soft material such as cloth or paper. This could trap the heat inside the unit and could cause a fire.

- To prevent the risk of fire or electric shock, never place the Printer in the following kind of places:
 - Narrow places with insufficient ventilation. (A cooling fan is installed inside the Printer on the right side and the rear side. However, to cool it more effectively, leave a space of 10 cm between the left side, right side, the rear and the top of the Printer and surrounding objects.)
 - On a carpet or bed.
 - Near heaters or strong spotlights.
 - Places with oily smoke, high humidity and dust.
 - Places exposed to direct sunlight for a long time.

Power Cable and Connection to Wall Outlet

- Do not operate the Printer with any other than the specified power source and voltage (AC 120 V). To do so could cause a fire or electric shock. Make sure that the correct power source and voltage are used before connecting the Power Cable.
- Do not connect the Power Cable with wet hands. It could cause electric shock and is very dangerous.
- Using the Printer with a damaged Power Cable is dangerous and could cause a fire or electric shock. Be sure to observe the following points:
 - Do not make any alteration to the Power Cable.
 - Do not place anything heavy on it or expose it to sharp edges or pointed objects.
 - Do not place it near a heater or some other hot object.
 - Do not bend it excessively or twist and yank it.
 - Always grasp the plug to connect to or disconnect it from a wall outlet. Yanking the cable could damage it.
- If the Power Cable is damaged (if the core is bared, broken, etc.), be sure to consult your dealer. Continuing to use a damaged Power Cable is dangerous and could cause a fire or electric shock.

Precautions for Safety

(Cont'd)

Modifying or Disassembling the Color Video Printer

- Never remove the cabinet and never try to modify or disassemble the Printer. This could cause a fire or electric shock. For checking, adjustment and repair of internal parts, consult your dealer.

In Case of Abnormal Operation

If the Printer emits smoke or an unusual smell, immediately turn off the power and disconnect the Power Cable from the wall outlet. Make sure that the smoke stops and then have your dealer check and, if necessary, repair the Printer. Do not try to repair it yourself, because it is dangerous.

Pay Attention to Children

- Prevent them from putting their hands into openings of the Printer such as the Ink Cassette Compartment. It could cause an electric shock.
- Caution them against stepping on the Printer, or hanging on to it. It could cause serious damage and injury.
- Prevent them from inserting small objects into the ventilation holes. It could cause a fire or electric shock.

Cautions for Use

Precautions for Chemicals

- Be careful not to expose the Printer to insecticide spray or volatile solvent such as benzine and thinner. They could damage the surface of plastic parts and cause the coating of the metal parts to fade or peel off.
- Do not leave rubber and vinyl products in contact with the Printer for a long time. They could damage the surface of plastic parts and cause the coating of the metal parts to fade or peel off.

Precautions for Transport

- Be sure to disconnect the plug of the Power Cable from the wall outlet.
- Hold the unit securely and take care not to bump it against other objects and not to drop it.
- When transporting the Printer long distances, such as when moving, use the Printer's original packing case or wrap it in a large towel or blanket to protect it against possible shocks.

When Not in Use

When not using the Printer on a daily basis:

- Turn the Printer off.
- Before going out or leaving on a longer trip, make sure to disconnect the Power Cable from the wall outlet.
As long as the Power Cable remains connected to the wall outlet, the Printer consumes approx. 4 W of power), even if it is turned off.
- Not using the Printer for a very long time could cause its performance to deteriorate, therefore, it should be activated from time to time.

Cleaning

- For safety reasons, unplug the Printer's Power Cable before cleaning.
- Wipe the cabinet and operation panel with a soft cloth.
- When the Printer is very dirty, use a cloth moistened with water and mild detergent, and then wipe with a dry cloth.
- When using a chemical cloth, follow its instructions.

Temperature Inside the Printer

- The internal temperature depends on the ambient temperature and the Printer's operation condition. If the temperature rises above a certain level, the [ERROR] Lamp flashes and the Error Message "WAIT: COOLING" appears on the TV screen. In this case, the Printer automatically stops printing temporarily. This is not a malfunction. Wait for a while (max. 4–5 minutes). As soon as the temperature has dropped to a normal level, printing will resume automatically.
- In the following cases, it may take considerably more than 4–5 minutes until printing is resumed.
 - ① When more than 10 prints are made in quick succession.
 - ② When the surrounding temperature is high.
 - ③ When the ventilation holes are blocked and the temperature inside the unit builds up.Therefore, be sure to place the Printer in a well-ventilated location.

Condensation

When condensation has formed inside the Printer, the [ERROR] Lamp flashes and the Printer cannot be operated. In this case, leave the Printer on and wait for approx. 2 hours. After the humidity inside the Printer has returned to a normal level, it will operate again.

- The first print made after condensation has been cleared up may be blurred because the paper and the roller may not yet be completely dry.
- As condensation forms gradually, it may take about 10–15 minutes before the [ERROR] Lamp flashes.

After a sudden change in the room temperature and humidity, confirm that the [ERROR] Lamp does not flash, before using the Printer.
- The cooling fan is automatically activated when condensation has formed or the temperature inside the Printer has risen above a certain level. As soon as the condensation has been resolved or the internal temperature has reached a normal level, the cooling fan automatically stops.

Conditions for Condensation:

Condensation may form if the Printer or the Video Print Set is brought to a place with very different temperature and/or humidity.

- Places with much steam and high humidity.
- When moving the Printer or the Video Print Set from a cold or air-conditioned room to a place with high temperature and humidity.
- A room where the heater has just been turned on.

Cautions for Use (Cont'd)

Printing Paper and Ink Cassette

To reduce the risk of deterioration of the picture quality or malfunction of the Printer, be sure to observe the following points:

■ Notes for Loading the Video Print Set

- Use only Video Print Sets bearing the "MP" logotype.
- To obtain optimum picture quality, use only the Printing Paper and the Ink Cassette packed together as a set in the same box.
- Be careful not to stain the ink film in the Ink Cassette and the printing side of paper with fingerprints. Do not write on the Printing Paper before printing.
- Be careful that the Printing Paper and the Ink Cassette do not become dusty before printing.
- The picture will be printed on the glossy side of the paper (the side without any printed markings). Be sure to load the paper with the glossy side facing upward into the Printer. If loaded incorrectly, printing is not possible.
- If the ink film in the Ink Cassette is loose, tighten it by turning the spool in the direction of arrow before loading.
- If the Print Set was stored in a cool place, wait until it has adapted to the room temperature, before opening it.
- Do not let more than 10 prints accumulate at the Print Exit. It could cause a paper jam.
- Do not print again on a finished print.
- Never use wet or bent Printing Paper or a wet Ink Cassette.

■ Notes for Storing the Video Print Set

- Do not leave the Ink Cassette and Printing Paper in places with high temperature and humidity for a long time. It could cause inferior printing quality. To store them, avoid high temperature and humidity and return them into the bags in which they were originally packed.
- Put the paper back into the original bag and store it flat. If stored standing on its side, the paper could become bent and warped, and this could cause, paper jam during printing.
- Do not expose the paper to direct sunlight for a long time. It could cause inferior picture quality.

■ Notes for Handling Finished Prints

- Do not stick adhesive tape to the printing side of prints nor leave the printing side in contact with vinyl products, plastic erasers, or similar objects. This could cause discoloration, color transfer or other damage to the prints due to chemical reaction.
- Do not spray or spill any liquid containing thinner, alcohol, etc. on the prints. This could cause discoloration of the prints.

- Never leave the printing side of two prints in contact with each other. This could cause color transfer.
- Avoid storing the prints in places with high temperature or humidity, or places exposed to direct sunlight for a long time. This could reduce the picture quality of the prints.
- If the prints are stacked and pressed together or if they are left in contact with other paper for a long time, some color transfer may occur.
- When storing the pictures in an album, it is recommended to use one with transparent pockets made of cellophane, nylon or materials similar to nylon.

■ Other Cautions

- Unauthorized printing of copyrighted material for commercial purposes is copyright infringement.
- If the Video Print Set has a defect or flaw caused by the manufacturing process, it can be exchanged for a new set of the same type. For any other defects, however, the manufacturer shall not be responsible.

The following two types of Video Print Sets can be used with this Video Color Printer.

(Use only the specified Video Print Sets and Video Print Ink Cassettes bearing the "MP" logotype.)

■ When Using the Optional Video Print Set (VW-MPS50P) (50 sheets)

- Do not affix any stamps or labels to the Printing Paper and do not write on the paper with a typewriter, etc. before printing. This could cause a paper jam.
- Do not write on the paper before printing.
- To write on the printing side of the paper after printing, use a permanent marker (felt pen with oil-based ink).
- Writing on the back side of the paper is possible with felt pens with oil- or water-based ink, pencils, ball-point pens, etc. Exerting strong pressure when writing by hand may cause traces to remain on the printing side.

■ When Using the Optional Video Print Set (VW-MPSS25P) (25 sheets/set)

- Do not peel the backing (marked side) off the adhesive paper before printing. This could cause a paper jam.
- Before attaching the print, wipe dust and dirt from the surface (paper, glass, plastic, metal, etc.) of the object where it is to be attached.
- When cutting out part of a print to use as adhesive label after printing, use a single-sheet cutter and cut with the backing still attached.

Error Indications

When an error occurs, an Error Message appears in the center of the TV screen to inform you. In addition, the [ERROR] Lamp or the [PAPER/INK] Lamp on the front panel of the Color Video Printer flashes.

Error Message	Remedy	Flashing Lamp
SET PAPER	●Insert Printing Paper correctly.	[PAPER/INK] Lamp
CHECK PAPER TYPE	●Use specified Printing Paper.	[ERROR] Lamp
SET TRAY OR INK	●Insert Printing Paper or Ink Cassette correctly.	[ERROR] Lamp
CHANGE INK	●Replace it with a new Ink Cassette.	[PAPER/INK] Lamp
REMOVE JAMMED PAPER	●Remove jammed paper.	[ERROR] Lamp
CHECK INK TYPE	●Use a specified Ink Cassette.	[ERROR] Lamp
WAIT: DRYING	●Wait for a moment. (→ P. 33 "Condensation")	[ERROR] Lamp
WAIT: COOLING	●Wait for a moment. (→ P. 33 "Temperature Inside the Printer")	[ERROR] Lamp
CHECK SIDE COVER	●Correctly close the Ink Cassette Side Cover.	[ERROR] Lamp
MOTOR LOCK	●Consult your dealer.	[ERROR] Lamp

Before Requesting Service

In case the Color Video Printer does not operate as expected, check the items listed below and try to remedy accordingly.

- if this is not possible, consult your dealer or a Panasonic service center.

Symptom	Cause	Remedy
The Printer cannot be switched on.	●The Power Cable is not connected correctly.	●Plug the Power Cable into a wall outlet correctly.
The colors of the prints are unnatural.	●The colors of the picture were not adjusted correctly.	●Adjust the picture quality correctly.
No picture appears on the TV screen.	●The external video source unit is not connected correctly to the Printer.	●Connect it correctly.
	●The Input Jack is not selected correctly. (→ P. 16)	●Select it correctly.
The printed pictures are not clear.	●The used paper is not of the specified type.	●Use specified paper.
	●The paper is not loaded correctly.	●Make sure that the paper is loaded with the glossy side facing upward.
Pressing the [MEMORY] Button does not store the picture in memory.	●The MENU Screen is displayed.	●Press the [EXEC] Button to terminate the MENU Mode.
	●The Picture stored in memory is displayed on the TV screen.	●Press the [MONITOR] Button to display the external picture on the screen.

Specifications

Informations for your safety

Power Source:	AC 120 V \pm 10% 50/60 Hz
Power Consumption:	110 Watts (during printing), 15 Watts (Power On), 4 Watts (Standby Mode)

Printing System: Thermal sublimation transfer printing system

Printing Speed: Approx. 75 sec/sheet

Picture Memory: 8 bit, 1 frame

Print Media

Ink Sheet: Cassette system (exclusive), 3 color field successive printing (yellow, magenta, cyan)

Printing Paper: Cut sheets; 100 \times 148 mm (postcard size)
Printing size; 84 \times 110 mm

Paper Feeding System: Automatic feeding (max. 25 sheets)

Picture Quality: 256 color gradations for each color [field memory/frame memory (still)]

Printing Resolution: Number of pixel: 464 \times 672 dots

Number of copies: Max. 10 sheets continuously

Functions: Multi Prints, Strobe Prints, Zoom Prints, Divide Prints

Print Head: Film Thermal Print Head 5.5 dots/mm

Input Jack: S-Video Input Jack: S Jack (Front 1, Rear 1)
Y (Luminance signal): 1.0 Vp-p, 75 Ω
C (Color signal): 0.3 Vp-p, 75 Ω
Video Input Jack: RCA Jack 1.0 Vp-p, 75 Ω (Front)
BNC Jack 1.0 Vp-p, 75 Ω (Rear)
Remote Control Jack (Rear)

Output Jack: S-Video Output Jack: S Jack
Y (Luminance signal): 1.0 Vp-p, 75 Ω
C (Color signal): 0.3 Vp-p, 75 Ω
Video Output Jack: BNC Jack 1.0 Vp-p, 75 Ω

Operating Temperature: 5 $^{\circ}$ C–35 $^{\circ}$ C

Weight: 7 $\frac{3}{4}$ lbs (3.5 kg)

Dimensions: 12 $\frac{1}{4}$ " (W) \times 3 $\frac{7}{16}$ " (H) \times 10 $\frac{1}{16}$ " (D)
[310 (W) \times 86.5 (H) \times 271.4 (D) mm]

Weight and dimensions shown are approximate.
Specifications are subject to change without notice.

Panasonic

Broadcast & Television Systems Company

Division of Matsushita Electric Corporation of America

Executive Office:

One Panasonic Way (3F-5), Secaucus, NJ 07094

REGIONAL OFFICES:

Eastern Regional Office: 54 West Gude Drive, Rockville, MD 20850

Central Regional Office: 1707 North Randall Road, Elgin, IL 60123

Southern Regional Office: 1225 Northbrook Parkway, Suite 107A, Suwanee, GA 30174

Western Regional Office: 6550 Katella Ave., Cypress, CA 90630

Matsushita Electric of Canada Limited/Matsushita Électrique du Canada Limitée

5770 Ambler Drive, Mississauga, Ontario L4W 2T3 TEL (416) 624-5010

Panasonic Sales Company

Division of Matsushita Electric of Puerto Rico Inc.

San Gabriel Industrial Park, 65th Infantry Ave., Km. 9.5, Carolina, Puerto Rico 00630



F0695A0-1000 (A)

Printed in Japan
VQT6110

