

ANY KEY ANSWER
30 CHANNEL OPERATION

9113
UNIQUE STAND UP DESIGN

USER'S MANUAL



INTRODUCTION

Parts Check List:

1. Handset
2. Base Unit
3. Telephone line cord
4. Battery Pack
5. AC Adapter

To purchase replacement battery packs, call VTECH Communications at 1-800-595-9511. In Canada, call VTECH Electronics at 1-800-267-7377.



HANDSET



BASE UNIT

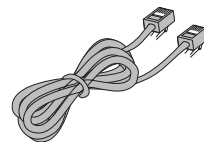

TELEPHONE CORD

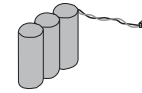

BATTERY PACK

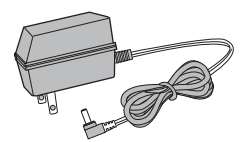

AC ADAPTER

To help protect the environment, this product may contain recycled or reconditioned parts and materials.

vtech

VTECH TELECOMMUNICATIONS LTD.

www.vtechphones.com

Printed in China 91-005303-040-000 ISSUED 0

900 MHz

1

IMPORTANT SAFETY INSTRUCTIONS

When using your telephone equipment, basic safety precautions should always be followed to reduce the risk of fire, electric shock and injury, including the following:

1. Read and understand all instructions.
2. Follow all warnings and instructions marked on the product.
3. Unplug this product from the wall outlet before cleaning. Do not use liquid cleaners or aerosol cleaners. Use a damp cloth for cleaning.
4. Do not use this product near water (for example, near a bath tub, kitchen sink, or swimming pool).
5. Do not place this product on an unstable cart, stand, or table. The product may fall, causing serious damage to the product.
6. Slots and openings in the cabinet and the back or bottom are provided for ventilation. To protect it from overheating, these openings must not be blocked by placing the product on the bed, sofa, rug, or other similar surface. This product should never be placed near or over a radiator or heat register. This product should not be placed in a built-in installation where proper ventilation is not provided.
7. This product should be operated only from the type of power source indicated on the marking label. If you are not sure of the type of power supply to your home, consult your dealer or local power company.
8. Do not allow anything to rest on the power cord. Do not locate this product where the cord will be abused by persons walking on it.
9. Never push objects of any kind into this product through cabinet slots, as they may touch dangerous voltage points or short out parts that could result in a risk of fire or electric shock. Never spill liquid of any kind on the product.
10. To reduce the risk of electric shock, do not disassemble this product. If service or repair work is required, contact VTECH Customer Service at 1-800-595-9511. Opening or removing cabinet parts other than specified access doors may expose you to dangerous voltages or other risks. Incorrect reassembling can cause electric shock when the appliance is subsequently used.
11. Do not overload wall outlets and extension cords as this can result in the risk of fire or electric shock.
12. Unplug this product from the wall outlet:
 - a) When the power supply cord or plug is damaged or frayed.
 - b) If liquid has been spilled into the product.
 - c) If the product has been exposed to rain or water.
 - d) If the product does not operate normally by following the operating instructions. Adjust only those controls that are covered by the operating instructions, because improper adjustment of other controls may result in damage and will often require extensive work to restore the product to normal operation.
 - e) If the product has been dropped and the cabinet has been damaged.
 - f) If the product exhibits a distinct change in performance.
13. Avoid using a telephone (other than a cordless type) during an electrical storm. There may be a remote risk of electric shock from lightning.
14. Do not use the telephone to report a gas leak in the vicinity of the leak.

SAVE THESE INSTRUCTIONS

2

INSTALLING/REPLACING THE BATTERY PACK

1. Slide the battery cover off by gently pressing on the recessed area with a downward motion.
2. Unplug and remove the old battery pack. Don't put the old battery pack in a trash compactor or a fire - it could burst.
3. With the red and black wires at the bottom of the pack, angle the top of the battery into the compartment, under the two "claws". Next, press the lower end of the battery pack down, so it is held in place by the lower claw. Now, plug the connector into the socket, located below the battery. Slip the battery wires into the wire guide, located below and to the left of the socket.
4. Replace the battery cover by sliding it into place.

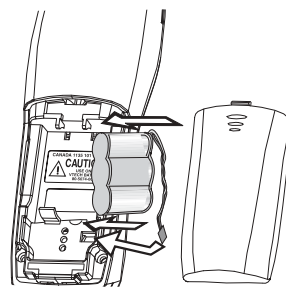

5. The new battery pack must be charged before using your telephone. Place the handset in the cradle of the base unit to allow it to charge for 16 hours. Maximum battery life between charges is more than 4.5 hours of continuous talk time or 6 days of standby.

CAUTION: To reduce the risk of fire or injury, read and follow these instructions:

1. Use only VTECH battery pack supplied, or equivalent.
2. Do not open or mutilate the battery. Released electrolyte is corrosive and may cause damage to the eyes or skin. It may be toxic if swallowed.
3. Exercise care in handling batteries in order not to short the battery with conducting materials such as rings, bracelets, and keys. The battery or conductor may overheat and cause burns.
4. Do not dispose of the battery in a fire. The cell may explode.

The RBRC™ Seal



The RBRC® Seal on the nickel-cadmium battery indicates that VTECH Communications, Inc. is voluntarily participating in an industry program to collect and recycle these batteries at the end of their useful lives, when taken out of service within the United States and Canada.

The RBRC® program provides a convenient alternative to placing used nickel-cadmium batteries into the trash or municipal waste, which may be illegal in your area.

VTECH's participation with RBRC® makes it easy for you to drop off the spent battery at local retailers participating in the RBRC® program or at authorized VTECH product service centers. Please call 1-800-8-BATTERY™ for information on Ni-Cd battery recycling and disposal bans / restrictions in your area. VTECH's involvement in this program is part of its commitment to protecting our environment and conserving natural resources.

RBRC® is a registered trademark of Rechargeable Battery Recycling Corporation.

3

GETTING STARTED

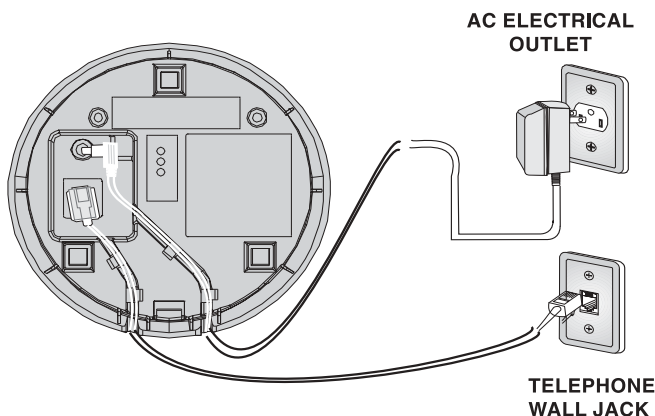

Setting Up Your VT9113

1. Choose an area near an electrical outlet and a telephone wall jack.
 2. Plug the AC power adapter into an electrical outlet and the DC connector to the power jack on the bottom of the Base Unit. Insert the cord in the channel guide.
- CAUTION:** Use only the AC adapter shipped with your VT9113. It is specifically designed for this product.
- NOTE:** Connect power to the Base Unit before placing the handset in the cradle.
3. **CHARGE THE HANDSET BATTERY PACK BEFORE USE.** The batteries recharge automatically whenever the Handset is in the Base Unit cradle. The batteries must be charged for 16 hours before using your phone for the first time.
 4. Connect the telephone line cord. Insert one end of the telephone line cord into the phone jack on the bottom of the Base Unit. Plug the other end into a telephone wall jack. Make sure the plugs snap securely into place. Insert the cord in the channel guide.
 5. **CHECK FOR A DIAL TONE.** After the battery pack is charged, pick up the Handset and press the ON key. The IN USE indicator should light up, and you should hear a dial tone. If not, see IN CASE OF DIFFICULTY.

CAUTION:

1. Never install telephone wiring during a lightning storm.
2. Never install telephone jacks in wet locations unless the jack is specifically designed for wet locations.
3. Never touch uninsulated telephone wires or terminals unless the telephone line has been disconnected at the network interface.
4. Use caution when installing or modifying telephone lines.

4

HANDSET FEATURES

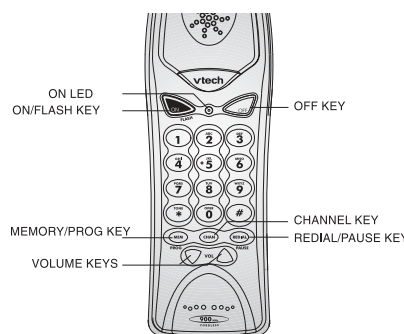

ON LED

- The ON LED lights when the Handset is on an active call.
- It flashes in cadence with an incoming ring.
- It flashes quickly during Programming mode.
- It flashes slowly when the battery pack is low.

ON/ FLASH KEY

- Press the ON key to make a call.
- If you are currently on a call, and you hear a call waiting tone, press ON to switch to the second call. Press ON again to return to the original call.

VOLUME CONTROL

- Adjust the volume of what you hear through the Handset.
- While on a call, press the ▲ or ▼ key to adjust the listening volume. The Handset will emit a double beep when the maximum or minimum volume level has been reached.

OFF KEY

- Press the OFF key to exit all modes of operation.

REDIAL / PAUSE KEY

- When you hear the dial tone, press REDIAL to call the last number dialed on your phone.
- It can also be used to store the last number dialed into the speed dial memory. See Storing a Redial Number into Speed Dial for details.
- You can store pauses into your speed dial numbers. See Storing Pauses in Memory for details.

CHAN KEY

- Pressing the CHAN key when the Handset is in use will activate a channel change to the next free channel.
- This is used if you are experiencing noise or interference on the current channel.

MEM/PROG KEY

- Press the MEM key to enter MEMORY mode.
- The sequence for dialing out a speed dial number in memory is: ON, MEM, Number Button (0-9).
- Press MEM/PROG to enter programming mode. See Programming Speed Dial Numbers for more details.

TONE/ * KEY

- In PULSE dialing mode, this key is used to switch to Temporary TONE dialing mode.

5

BASE UNIT FEATURES

IN USE/CHARGING LED

- The LED illuminates steadily when the Handset is in the Base cradle to indicate that the Handset battery is being charged.
- The LED illuminates whenever the Handset is being used.
- This LED also flashes with the cadence of the incoming ring.

PAGE KEY

- Press the **PAGE** key to page the Handset.
- Press it second time to cancel a page.
- The Base will ring the Handset for 1 minute before ending the page automatically.
- The Handset can also cancel the page by pressing the **OFF** key.

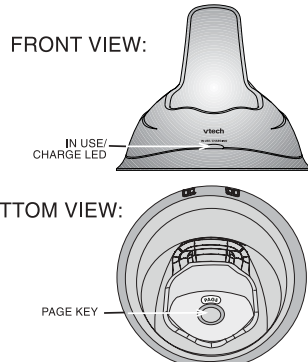

6

OPERATING INSTRUCTIONS

Temporary Tone

If you have a rotary (dial-pulse) telephone service, (**TONE/PULSE** setting is set to **PULSE**), this feature allows you to enter special codes and tones to operate answering machines, use electronic banking services, calling cards, or other special services.

First, dial the call normally. Then activate the Temporary Tone feature by pressing **TONE** (the * key). You can then press the numbers or symbols you need, and your phone will send the proper signals.

To end the call, press **OFF** or place the Handset back in the Base. The phone will automatically go back to rotary (dial-pulse) service.

Programming The Ringer Type

The Handset ringer is capable of four different types of ringing tones. The following sections detail how to change the different tones and to turn off a ringer on the Handset.

To program, the Handset must be **OFF**.

To select a different ringer type do the following:

- Press **MEM/PROG**.
- Press the **#** key.
- Press a key **1-4** to select a ringer type.
- Press the **MEM** key to confirm.

Turning Off The Ringer

To turn off the ringer on the Handset, do the following:

- Press **MEM/PROG**.
- Press the **#** key
- Press **5** to turn off the ringer
- Press the **MEM** key to confirm
- To turn the ringer on again, see **Programming the Ringer Type**.

Checking The Ringer

To check the ringer which is currently programmed, do the following:

- Press **MEM/PROG**.
- Press the **#** key
- Press **0**
- Press the **MEM** key to confirm

Memory Dialing

The **VT9113** can store up to 10 different phone numbers that you can dial just by pressing phone, **MEM** and one of the number keys (**0-9**).

Programming Speed Dial Numbers

The Handset must be **OFF**.

1. Press **MEM/PROG**. The **ON LED** will blink to indicate that you are in the programming mode.
2. Press the number of the memory location you wish to store the number in (**0-9**).
3. Using the dial pad, dial the number you want to store. The number can be up to 16 digits long. The number can be entered manually or by using **REDIAL**.
4. Press **MEM** to store the phone number to the key you selected.

The phone now exits programming mode and emits a tone.

8

IN CASE OF DIFFICULTY

If you have difficulty operating your phone, the suggestions below should solve the problem. If you still have difficulty after trying these suggestions,

In the **US** Call:

VTECH
Communications at
1-800-595-9511.

In **Canada** Call:

VTECH Electronics at
1-800-267-7377.

THE PHONE DOESN'T WORK AT ALL.

- Make sure the power cord is plugged in.
- Make sure the telephone line cord is plugged firmly into the Base Unit and the telephone wall jack.
- Make sure the batteries are properly charged. If the Handset makes two beeps, the batteries need charging. If the **IN USE** indicators do not light when you press **ON**, you must charge the batteries.
- If you recently installed a new battery pack, make sure it is installed correctly.

NO DIAL TONE.

- First check all the suggestions above.
- If you still don't hear a dial tone, disconnect the Base Unit from the telephone jack and connect a different phone. If there is no dial tone on that phone either, the problem is in your wiring or local service. Call your local telephone company.

YOU GET NOISE, STATIC, OR A WEAK SIGNAL EVEN WHEN YOU'RE NEAR THE BASE UNIT.

Household appliances plugged into the same circuit as the Base Unit can sometimes cause interference. Try moving the appliance or the Base Unit to another outlet.

YOU GET NOISE, STATIC, OR A WEAK SIGNAL WHEN YOU'RE AWAY FROM THE BASE UNIT.

- You may be out of range. Either move closer to the Base, or relocate the Base Unit.
- The layout of your home may be limiting the range. Try moving the Base Unit to the second or third floor, or to some other location.

THE HANDSET DOES NOT RING WHEN YOU RECEIVE A CALL.

- Ensure that the ringer is turned on.
- Make sure the telephone line cord is plugged firmly into the Base Unit and the telephone jack. Make sure the power cord is plugged in.
- You may be too far from the Base Unit.
- You may have too many extension phones on your telephone line to allow all of them to ring. Try unplugging some of the other phones.

YOUR CALLER FADES IN AND OUT.

You may be nearly out of range. Move closer, or relocate the Base.

10

OPERATING INSTRUCTIONS

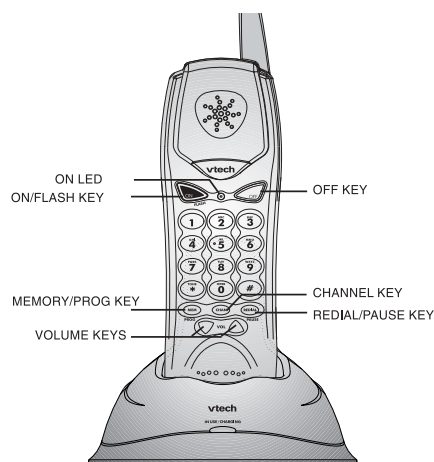

Making Calls

Pick up the Handset and press **ON**. When you hear a dial tone, dial the number. The **ON LED** will illuminate while the Handset is in use.

If you make a mistake when dialing, press **OFF** to hang up, then press **ON** to get the dial tone again. You must always press **ON** before you can dial a call on the Handset.

Answering Calls

When an incoming call is ringing, the **IN USE LED** on the Base and **ON LED** on the Handset will flash. To make sure your phone rings when the Handset is away from the Base, please keep the Base antenna in the upright position.

To answer a call when the Handset is in the Base, just pick up the Handset.

To answer a call when the Handset is away from the Base, just press any key on the Handset (except

OFF). This is very useful in a dark environment; you do not have to fumble around looking for the **ON** key to answer the call.

Disconnecting

To end a call, either place the Handset back in the Base, or press **OFF** on the Handset.

Changing Channels

If you notice interference when using your Handset, press **CHAN** to switch to a clear channel. This function is only available when you are on a call.

TONE/PULSE Setting

If you have touch tone service on phone line. Press **MEM/PROG**, *, *, **MEM** to switch to **TONE** dialing. If you have rotary service, press **MEM/PROG**, *, #, **MEM** to switch to **PULSE**.

NOTE: Your **VT9113** is preset at the factory for **TONE** dialing.

7

OPERATING INSTRUCTIONS

Speed Number Dialing

1. Press **ON** to get a dial tone.
2. Press **MEM** and the memory location number key (**0-9**).

For example, to dial the number you assigned to key '8', you would press **ON, MEM, 8**.

To Change or Replace a Speed Dial Number

To change or replace a stored number in speed dial memory simply enter the new number and store it in the memory location you wish to change.

For example, to change the number stored in memory position 7 to 555-1111, you would press **MEM/PROG, 7, 555-1111, MEM**.

Storing Pauses in Memory

To insert a pause in a phone number, press **REDIAL/PAUSE**. The pause is 2 seconds in length. For longer pauses, press **REDIAL/PAUSE** two or more times. Each additional press indicates an additional 2 second pause.

If your phone is connected to a PBX you can store the PBX access number and a pause before the phone number. For example, to store **9-PAUSE-555-1234** in memory location 8 do the following:

1. Press **MEM/PROG**
2. Press **8**
3. Press **9**
4. Press **REDIAL/PAUSE**
5. Dial **555-1234**
6. Press **MEM**

Using REDIAL

To redial the last number you called, press **ON** then press **REDIAL**. The phone will automatically dial the number.

Storing a Redial Number into Speed Dial

To store the last number you dialed as a Speed Dial number, press **MEM/PROG**, a location number (**0-9**), **REDIAL, MEM**.

The Page Feature

From the Base Unit, press **PAGE** to signal the person at the Handset. To end the page at the base, press **PAGE** again. To end the page at the Handset, press **OFF**.

If the Handset is in use (off-hook) when **PAGE** is pressed on the Base Unit, the Handset will emit one page alert. If the Handset is not in use (on hook), the page alert will continue for approximately 60 seconds.

This feature is useful in locating a misplaced Handset.

9

IN CASE OF DIFFICULTY

YOU HEAR OTHER CALLS WHILE USING YOUR PHONE.

- Replace the Handset in the Base cradle, wait a few moments and try again.
- Disconnect your Base Unit from the telephone jack, and plug in a regular telephone. If you still hear other calls, the problem is probably in your wiring or local service. Call your local telephone company.

YOU HEAR NOISE IN THE HANDSET, AND NONE OF THE KEYS OR BUTTONS WORK.

- Make sure the power cord is plugged in.
- Your Base Unit and Handset may not be operating on the same channel or security code. Place the Handset in the cradle for a few moments to reload the security code and reset the channel.

COMMON CURE FOR ELECTRONIC EQUIPMENT

Electronics, like people, can sometimes get confused. If the unit does not seem to be responding normally, then try putting the Handset in the cradle to re-initialize the unit. If it still does not seem to respond, perform the following steps (in the order listed):

1. Disconnect the power to the Base.
2. Disconnect the Handset battery pack.

3. Wait a few minutes.
4. Connect power to the Base.
5. Reconnect the Handset battery.
6. Place the Handset in the Base Unit cradle. If the Handset has not been recently charged, allow 8 hours before use.

11

WARRANTY STATEMENT

What does this limited warranty cover?

- The manufacturer of this VTECH product, **VTECH Communications**, warrants to the holder of a valid proof of purchase ("Consumer" or "you") that the product and all accessories provided by VTECH in the sales package ("Product") are free from material defects in material and workmanship, pursuant to the following terms and conditions, when installed and used normally and in accordance with operation instructions. This limited warranty extends only to the Consumer for Products purchased and used in the United States of America.

What will VTECH Communications do if the Product is not free from material defects in materials and workmanship during the limited warranty period ("Materially Defective Product")?

- During the limited warranty period, VTECH's authorized service representative will repair or replace at VTECH's option, without charge, a Materially Defective Product. If we repair this product, we may use new or refurbished replacement parts. If we choose to replace this product, we may replace it with a new or refurbished product of the same or similar design. VTECH will return repaired or replacement products to you in working condition. VTECH will retain defective parts, modules,

or equipment. Repair or replacement of Product, at VTECH'S option, is your exclusive remedy. You should expect the repair or replacement to take approximately 30 days.

How long is the limited warranty period ?

- The limited warranty period for the product extends for ONE(1) YEAR from the date of purchase if we repair or replace a Materially Defective Product under the terms of this limited warranty. This limited warranty also applies to repaired or replacement Products for a period of either (a) 90 days from the date the repaired or replacement Product is shipped to you or (b) the time remaining on the original one-year warranty; whichever is longer.

What is not covered by this limited warranty ?

This limited warranty does not cover

- Product that has been subjected to misuse, accident, shipping or other physical damage, improper installation, abnormal operation or handling, neglect, inundation, fire, water or other liquid intrusion; or
- Product that has been damaged due to repair, alteration or modification by anyone other than an authorized service representative of VTECH; or
- Product to the extent that the problem experienced is caused by signal conditions, network reliability or cable or antenna systems; or

12

WARRANTY STATEMENT

communications related to this Product. VTECH provides no other warranties for this product. The warranty exclusively describes all of VTECH's responsibilities regarding the product. There are no other express warranties. No one is authorized to make modifications to this limited warranty and you should not rely on any such modification.

State Law Rights: This warranty gives you specific legal rights, and you may also have other rights which vary from state to state.

Limitations: Implied warranties, including those of fitness for a particular purpose and merchantability (an unwritten warranty that the product is fit for ordinary use) are limited to one year from date of purchase. Some states do not allow limitations on how long an implied warranty lasts, so the above limitation may not apply to you.

- In no event shall VTECH be liable for any indirect, special, incidental, consequential, or similar damages (including, but not limited to lost profits or revenue, inability to use the product, or other associated equipment, the cost of substitute equipment, and claims by third parties) resulting from the use of this product. Some states do not allow the exclusion or limitation of incidental or consequential

damages, so the above limitation or exclusion may not apply to you.

14

FCC, ACTA and IC REGULATIONS

This equipment complies with Parts 15 of the Federal Communications Commission (FCC) rules for the United States. It also complies with regulations RSS210 and CS-03 of Industry and Science Canada. Operation is subject to the following two conditions: (1) this device may not cause interference, and (2) this device must accept any interference, including interference that may cause undesired operation of the device.

A label is located on the underside of the Base Unit containing either the FCC registration number and Ringer Equivalence Number (REN) or the IC registration number and Load Number. You must, upon request, provide this information to your local telephone company.

This equipment is compatible with inductively coupled hearing aids.

Should you experience trouble with this telephone equipment, please contact:

VTech Communications Inc

CUSTOMER SERVICE at 1-800-595-9511. In Canada, call VTech Electronics Ltd. at 1-800-267-7377.

For repair/warranty information. The telephone company may ask you to disconnect this equipment from the line network until the problem has been corrected.

FCC Part 15

Warning: Changes or modifications to this unit not expressly approved by the party responsible for compliance could void the user's authority to operate the equipment.

The equipment has been tested and found to comply with part 15 of the FCC rules. These limits are designed to provide reasonable protection against harmful interference in a residential installation. This equipment generates, uses and can radiate radio frequency energy and, if not installed and used in accordance with the instructions, may cause harmful interference to radio communications. However, there is no guarantee that interference will not occur in a particular installation. If this equipment does cause harmful interference to radio or television reception, which can be determined by turning the equipment off and on, the user is encouraged to try and correct the interference by one or more of the following measures:

- Reorient or relocate the receiving antenna.
- Increase the separation between the equipment and receiver.
- Connect the equipment into an outlet or on a circuit different from that to which the receiver is connected.

16

WARRANTY STATEMENT

- Product to the extent that the problem is caused by use with non-VTECH electrical accessories; or
- Product whose warranty/quality stickers, Product serial numbers plates or electronic serial numbers have been removed, altered or rendered illegible; or
- Product purchased, used, serviced, or shipped for repair from outside the United States, or used for commercial or institutional purposes (including but not limited to Products used for rental purposes); or
- Product returned without valid proof of purchase (see 2 below); or
- Charges for installation or set up, adjustment of customer controls, and installation or repair of systems outside the unit.

How do you get warranty service?

- To obtain warranty service in the United States of America, call 1 800-595-9511 for instructions regarding where to return the Product. Before calling for service, please check the user's manual. A check of the Product controls and features may save you a service call.
- Except as provided by applicable law, you assume the risk of loss or damage during transit and transportation and are responsible for delivery or handling charges incurred in the transport of Product(s) to the service location.

VTECH will return repaired or replaced product under this limited warranty to you, transportation, delivery or handling charges prepaid. VTECH assumes no risk for damage or loss of the Product in transit.

- If the Product failure is not covered by this limited warranty, or proof of purchase does not meet the terms of this limited warranty, VTECH will notify you and will request that you authorize the cost of repair prior to any further repair activity. You must pay for the cost of repair and return shipping costs for the repair of Products that are not covered by this limited warranty.

What must you return with the Product to get warranty service?

- Return the entire original package and contents including the Product to the VTECH service location along with a description of the malfunction or difficulty;
- Include "valid proof of purchase" (sales receipt) identifying the Product purchased (Product model) and the date of purchase or receipt; and
- Provide your name, complete and correct mailing address, and telephone number.

Other Limitations

- This warranty is the complete and exclusive agreement between you and VTECH. It supersedes all other written or oral

13

MAINTENANCE

Your VT 9113 cordless telephone contains sophisticated electronic parts so it must be treated with care.

Avoid rough treatment

Place the handset down gently. Save the original packing materials to protect your telephone if you ever need to ship it.

Avoid Water

Your telephone can be damaged if it gets wet. Do not use the handset outdoors in the rain, or handle it with wet hands. Do not install your base unit near a sink, bathtub or shower. Remember that electrical appliances can cause serious injury if used when you are wet or standing in water. If your base unit should fall into water, **DO NOT RETRIEVE IT UNTIL YOU UNPLUG THE POWER CORD AND TELEPHONE LINE CORDS FROM THE WALL.** Then pull the unit out by the unplugged cords.

Electrical Storms

Electrical storms can sometimes cause power surges harmful to electronic equipment. For your own safety, use caution when using electric appliances during storms.

Cleaning your telephone

Your telephone has a durable plastic casing that should retain its luster for many years. Clean it only with a soft cloth slightly dampened with water or a mild soap. Do not use excess water or cleaning solvents of any kind.

TECHNICAL SPECIFICATIONS

FREQUENCY CONTROL

Crystal Controlled Dual PLL Synthesizer

TRANSMIT FREQUENCY

Handset: 923.10 MHz to 927.75 MHz

Base: 902.3 MHz to 906.65 MHz

RECEIVE FREQUENCY

Handset: 902.3 MHz to 906.65 MHz

Base: 923.10 MHz to 927.75 MHz

NOMINAL EFFECTIVE RANGE

Maximum power allowed by FCC and IC. Actual operating range may vary according to environmental conditions at the time of use.

SIZE

Handset: 17.5cm x 5.5cm x 3.9cm (L x W x T) maximum (antenna excluded)

Base: 19.3cm x 14.8cm x 5.4cm (L x W x T) maximum (antenna excluded)

WEIGHT

Handset: 146 grams

Base: 283 grams

POWER REQUIREMENTS

Handset: Self-contained nickel-cadmium rechargeable battery supply, 3.6V nominal, 300mAh capacity.

Power Adapter: 9V DC @ 200mA

SPECIFICATIONS ARE TYPICAL AND MAY CHANGE WITHOUT NOTICE.

15

FCC, ACTA and IC REGULATIONS

- Consult the dealer or an experienced radio/TV technician for help.

FCC Part 68 and ACTA

If this equipment was approved for connection to the telephone network prior to July 23, 2001, it complies with Part 68 of the Federal Communications Commission (FCC) rules. If the equipment was approved after that date, it complies with the Part 68 rules and with Technical Requirements for Connection of Equipment to the Telephone Network adopted by the Administrative Council for Terminal Attachments (ACTA). We are required to provide you with the following information.

1. Product identifier and REN information

The label on the back or bottom of this equipment contains, among other things, an identifier indicating product approval and the Ringer Equivalence Number (REN). This information must be provided to your local telephone company upon request. For equipment approved prior to July 23, 2001, the product identifier is preceded by the phrase "FCC Reg No." and the REN is listed separately. For equipment approved after that date, the product identifier is preceded by "US" and a colon (:), and the REN is encoded in the product identifier without a decimal point as the sixth and

seventh characters following the colon. For example, the product identifier US:AAAEQ03T123XYZ would indicate an REN of 0.3.

The REN is used to determine how many devices you may connect to your telephone line and still have them ring when you are called. In most, but not all areas, the sum of all RENs should be five (5.0) or less. You may want to contact your local telephone company for more information.

2. Connection and use with the nationwide telephone network

The plug and jack used to connect this equipment to the premises wiring and the telephone network must comply with the applicable Part 68 rules and technical requirements adopted by ACTA. A compliant telephone cord and modular plug is provided with this product. It is designed to be connected to a compatible modular jack that is also compliant. An RJ11 jack should normally be used for connecting to a single line and an RJ14 jack for two lines. See Installation Instructions in the user's manual. This equipment may not be used with Coin Telephone Lines or with Party Lines. If you have specially wired alarm dialing equipment connected to your telephone line, ensure the connection of

17

this equipment does not disable your alarm equipment. If you have questions about what will disable alarm equipment, consult your telephone company or a qualified installer.

3. Repair instructions

If this equipment is malfunctioning, it must be unplugged from the modular jack until the problem has been corrected. Repairs to this telephone equipment can only be made by the manufacturer or its authorized agents. For repair procedures, follow the instructions outlined under the Limited Warranty.

4. Rights of the telephone company

If this equipment is causing harm to the telephone network, the telephone company may temporarily discontinue your telephone service. The telephone company is required to notify you before interrupting service. If advance notice is not practical, you will be notified as soon as possible. You will be given the opportunity to correct the problem and the telephone company is required to inform you of your right to file a complaint with the FCC. Your telephone company may make changes in its facilities, equipment, operation, or procedures that could affect the proper functioning of this product. The telephone company is required to notify you if such changes are planned.

5. Hearing aid compatibility

If this product is equipped with a corded or cordless handset, it is hearing aid compatible.

6. Programming/testing of emergency numbers

If this product has memory dialing locations, you may choose to store police, fire department and emergency medical service telephone numbers in these locations. If you do, please keep three things in mind:

- a We recommend that you also write the telephone number on the directory card, so that you can still dial the emergency number manually if the memory dialing feature doesn't work.
- b This feature is provided only as a convenience, and the manufacturer assumes no responsibility for customer reliance upon the memory feature.
- c Testing the emergency telephone numbers you have stored is not recommended. However, if you do make a call to an emergency number:
 - You must remain on the line and briefly explain the reason for the call before hanging up.
 - Programming/testing of emergency numbers should be performed during off-peak hours, such as in the early morning or late evening, when the emergency services tend to be less busy.

IC (Industry Canada)

This telephone is registered for use in Canada.

Notice :

The REN assigned to this device denotes the number of devices you may connect to the telephone loop which is used by the device to prevent overloading. The termination on a loop may consist of any combination of devices subjected only to the requirement that the sum of the REN does not exceed five (5.0)

Notice :

The Industry Canada label identifies certified equipment. This certification means that the equipment meets certain telecommunications network protective, operational and safety requirements. The Department does not guarantee the equipment will operate to the user's satisfaction.

Before installing this equipment, users should ensure that it is permissible to be connected to the facilities of the local telecommunications company. The equipment must also be installed using an acceptable method of connection. The customer should be aware that compliance with the above conditions may not prevent degradation of services in some situations.

Repairs to certified equipment should be made by an authorized Canadian maintenance facility designated by the supplier. Any repairs or alterations made by the user to this equipment, or equipment malfunctions, may give the

telecommunications company cause to request the user to disconnect the equipment.

Users should ensure for their own protection that the electrical ground connections of the power utility, telephone lines and internal metallic water pipe system, if present, are connected together. This precaution may be particularly important in rural areas.

Caution :

Users should not attempt to make such connections themselves, but should contact the appropriate electrical inspection authority, or electrician, as appropriate. Your **VT9113** is designed to operate at the maximum power allowed by the FCC and IC. This means your Handset and Base Unit can communicate only over a certain distance - which will depend on the location of the Base Unit and Handset, weather, and the construction and layout of your home or office.

REPLACEMENT BATTERY ORDER FORM

For VT 9113 Cordless Telephone

Name: _____ Adress: _____

City: _____ State: _____ Zip: _____

Daytime Phone Number: (_____) - _____

ORDER INFORMATION

For Model VT 9113

_____ (QTY.) Batteries @\$14.95 each\$ _____

Shipping/Handling @\$ 4.95 per battery\$ _____

METHOD OF PAYMENT: DO NOT SEND CASH

- CHECK/M.O. VISA MASTERCARD DISCOVER
 AMERICAN EXPRESS

Credit Card# _____ EXP. DATE _____

CARD HOLDER'S SIGNATURE _____

PLACE ORDER FORM AND PAYMENT IN ENVELOPE AND SEND TO:

VTECH ADVANCED AMERICAN TELEPHONES

P.O. BOX 167

HAZELWOOD, MO 63042

YOU MAY ALSO ORDER BY PHONE. CALL 1-800-595-9511