

vtech[®]
Innovation Beyond Technology[™]



User's manual

www.vtechphones.com

Models: CS2111
CS2112
CS2111-11

24
GHz
Technology

Congratulations

on purchasing your new VTech product.
Before using this telephone, please read the
Important safety instructions
on page 34 of this manual.

This manual has all the feature operations and troubleshooting necessary to install and operate your new VTech telephone. Please review this manual thoroughly to ensure proper installation and operation of this innovative and feature rich VTech product. For support, shopping, and everything new at VTech, visit our website at www.vtechphones.com. In Canada, please visit www.vtechcanada.com.



The ENERGY STAR® program (www.energystar.gov) recognizes and encourages the use of products that save energy and help protect our environment. We are proud to mark this product with the ENERGY STAR® label indicating it meets the latest energy efficiency guidelines.

Table of contents

Getting started	1	Make calls	12
Parts checklist	1	Answer calls	12
Telephone base installation.	2	End calls	12
Battery installation and charging	3	Volume	12
Wall mounting.	4	Channel	12
Handset layout	5	Call waiting	13
Telephone base layout	6	Temporary tone dialing	13
Telephone settings	7	Redial	14
Date and time	7	Find handset	14
Ringer.	8	Directory	15
Ringer volume	8	Store a directory entry	15
Dial mode	9	Character chart	16
Home area code	9	Review the directory	17
Language	10	Edit a directory entry	18
Clear voicemail	11	Delete a directory entry	19
Telephone operation	12	Copy a directory entry into speed dial	20

Table of contents

Dial a number from the directory	20	Handset display screen messages	32
Speed dial	21	Battery	33
Store a speed dial entry	21	Important safety instructions	34
Edit a speed dial entry	22	Troubleshooting	35
Delete a speed dial entry	23	Operating range	44
Dial a speed dial number	23	Maintenance	44
Reassign speed dial locations	24	About cordless telephones	45
About caller ID	25	Warranty	45
Call log	26	FCC, ACTA and IC regulations	47
Review the call log	27	The RBRC® seal	48
Make a call log entry ready to dial	27	Technical specifications	49
Dial a call log number.	28	Index	50
Save a call log entry to the directory	29		
Delete from the call log	30		
Call log display screen messages	31		
Appendix.	32		

Getting started

Parts checklist

Your telephone contains the following items. Save your sales receipt and original packaging in case your telephone needs warranty service.



1. Handset



2. Telephone line cord



3. Telephone base power adapter



4. Battery compartment cover



5. Battery

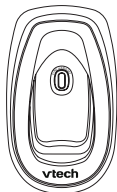

6. Telephone base

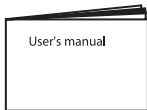

7. User's manual

www.vtechphones.com

note

- To purchase a replacement battery or power adapter, visit our website at www.vtechphones.com or call 1 (800) 595-9511. In Canada, go to www.vtechcanada.com or call 1 (800) 267-7377.

note

- Use only the power adapter supplied with this product. To order a replacement, visit our website at www.vtechphones.com or call 1 (800) 595-9511. In Canada, go to www.vtechcanada.com or call 1 (800) 267-7377.
- The power adapter is intended to be correctly oriented in a vertical or floor mount position. The prongs are not designed to hold the plug in place if it is plugged into a ceiling or an under-the-table/cabinet outlet.

Getting started

Telephone base installation

Install the telephone base as shown below. Make sure that the electrical outlet is not controlled by a wall switch. Also, if you receive high speed internet through your telephone line (commonly referred to as DSL), you may need to install a DSL filter to the telephone line between the telephone base and the telephone wall jack. Contact your DSL service provider for more information about DSL filters.

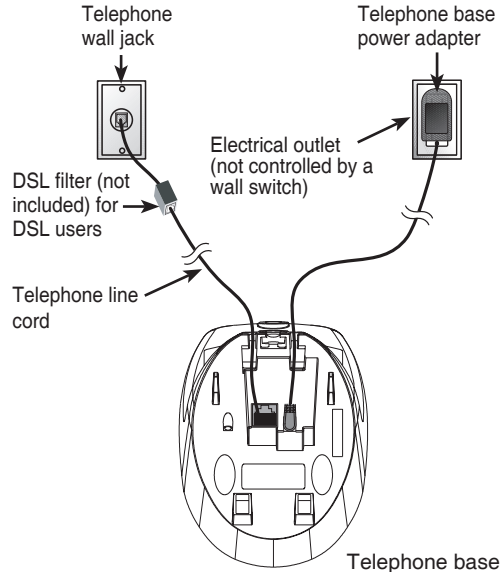

Getting started

Battery installation and charging

Install the battery as shown below. The battery may have enough charge for short calls. For best performance, charge the battery for at least 16 hours before use. When the battery power is low, the handset will beep, **LOW BATTERY** and the low battery indicator ☒ will be displayed on the handset screen. When fully charged, the handset battery provides approximately three and a half hours of talk time or three and a half days of standby time.

1. Insert the plug of the battery as indicated. Make sure it is plugged securely and matches the color-coded label inside the battery compartment.
2. Place the battery with the label **THIS SIDE UP** facing up and the wires inside the battery compartment.
3. Align the battery with the battery compartment cover flat against the battery compartment, then slide it upwards until it clicks into place.
4. Charge the handset by placing it in the telephone base and **CHARGING...** will be displayed on the handset screen.

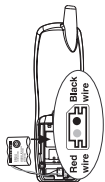

www.vtechphones.com

note

- If the handset will not be used for a long period of time, remove the battery to prevent possible leakage.
- To purchase a replacement battery, visit our website at www.vtechphones.com or call 1 (800) 595-9511. In Canada, go to www.vtechcanada.com or call 1 (800) 267-7377.

Getting started

Wall mounting

Your telephone base is ready for desktop use. If you prefer to mount your telephone on the wall (optional), it is designed to mount on a standard telephone wall plate.

You can mount the telephone base on the wall by positioning it so the mounting studs will fit into the corresponding holes on the telephone base. Slide the telephone base down on the mounting studs until it locks into place.

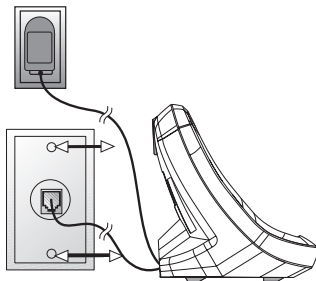

Getting started

Handset layout

▼/VOL-/CID

- When the telephone is not in use, press to review the call log.
- Press and hold to adjust the ringer volume when in idle mode.
- During a call, press to decrease the listening volume. A double beep will sound at the lowest setting.
- Press to scroll down while in programming mode.

TALK/FLASH

- Press to make or answer a call.
- During a call, press to receive an incoming call when you receive a call waiting alert.

PROG

- Press to enter programming mode while the telephone is not in use.

TONE*

- Press to switch to tone dialing temporarily when using pulse (rotary) service (page 13).

CHAN/DELETE

- Switch to a clearer channel while on a call.
- Press and hold to delete all records in the call log when in idle mode.
- When reviewing the call log or redial list, press to delete the displayed record.

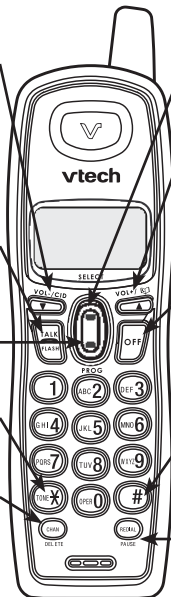

SELECT

- Press to store a programming option or a directory entry.

▲/VOL+/BOOK

- Press to display the directory when the telephone is not in use.
- Press and hold to adjust the ringer volume when the telephone is not in use.
- During a call, press to increase the listening volume. A double beep will sound at the highest setting.
- Press to scroll up while in programming mode.

OFF

- During a call, press to hang up.
- Press and hold for two seconds when the telephone is not in use to erase the **MISSED CALLS** display.
- During programming, press to exit without making changes.

#

- Press repeatedly to display other dialing options when reviewing the call log (page 27).
- Press to enter the **CLR VOICEMAIL** submenu while in the menu.

REDIAL/PAUSE

- Press repeatedly to review the redial list.
- While dialing or entering numbers into the directory, press to insert a dialing pause.

Getting started

Telephone base layout

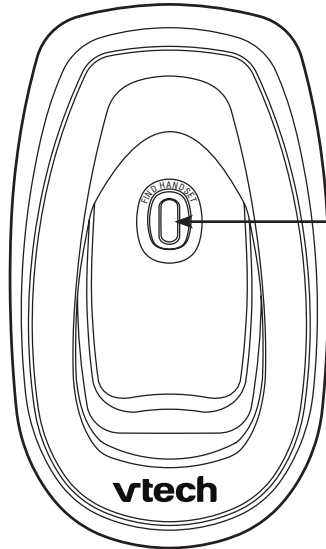

FIND HANDSET

- Press to page the handset.

Telephone settings

Date and time

If you subscribe to caller ID service, the date and time will be set automatically with the next incoming call. If you do not have caller ID service, you can set the date and time manually.

1. Press **PROG** when the handset is in idle mode.
2. Press ▼ or ▲ until **DATE/TIME** is displayed. Press **SELECT**.
3. When the hour is flashing, press ▼ or ▲ until the screen displays the correct hour and then press **SELECT**.
4. When the minute is flashing, press ▼ or ▲ until the screen displays the correct minute and then press **SELECT**.
5. When **AM** or **PM** is flashing, press ▼ or ▲ to choose **AM** or **PM** and then press **SELECT**.
6. When the month is flashing, press ▼ or ▲ until the screen displays the correct month and then press **SELECT**.
7. When the date is flashing, press ▼ or ▲ until the screen displays the correct date and then press **SELECT**.
8. You will hear a confirmation tone.

note

- In the event of a power failure, the time may need to be reset.

note

- If the ringer volume is set to off, **RINGER OFF** will be displayed.
- Even if the ringer is set to off, the handset will still ring when you press **FIND HANDSET**.

Telephone settings

Ringer

You can select from the different ringers.

1. Press **PROG** when the handset is in idle mode.
2. Press ▼ or ▲ until the screen displays **RINGER:** and the current setting.
3. Press **SELECT**. The current setting flashes, and you will hear a sample of the ringer.
4. Press ▼ or ▲ to select **RINGER: 1, 2, 3** or **4**. You will hear a sample of each ringer.
5. Press **SELECT** to confirm your selection. You will hear a confirmation tone.

Ringer volume

You can change the ringer volume to a comfortable level or turn the ringer off.

1. Press and hold ▲ or ▼ until the screen displays **RINGER VOL:** and the current setting when the handset is in idle mode. You will hear a sample of the ringer volume.
-OR-
 - Press **PROG** when the handset is in idle mode. Press ▼ or ▲ until the screen displays **RINGER VOL:** and the current setting.
 - Press **SELECT**. The current setting flashes, and you will hear a sample of the ringer volume.
2. Press ▲ or ▼ to select ringer volume from **OFF, LOW** or **HI**. You will hear a sample of the selected volume level.
3. Press **SELECT** to confirm your selection. You will hear a confirmation tone.

Telephone settings

Dial mode

If you have touch tone service, the telephone is ready for use as soon as the battery is charged. If you have pulse (rotary) service, you will need to change the dial mode.

1. Press **PROG** when the handset is in idle mode.
2. Press ▼ or ▲ until the screen displays **DIAL MODE:** and the current setting.
3. Press **SELECT**. The current setting flashes.
4. Press ▼ or ▲ to select **TONE** or **PULSE**.
5. Press **SELECT** to confirm your selection. You will hear a confirmation tone.

Home area code

If you dial your local calls using only seven digits (no area code required), program your home area code following the steps below. By programming your home area code, caller ID will display only the phone number without area code when you receive calls from callers in your local area.

1. Press **PROG** when the handset is in idle mode.
2. Press ▼ or ▲ until the screen displays **HOME AREA CODE**.
3. Press **SELECT**. The stored area code is displayed with the first digit flashing.
4. Use the dial key pad to enter the desired home area code.
5. Press **SELECT** to confirm. You will hear a confirmation tone.

note

- If, in the future, your phone service provider requires you to dial the area code when making a local call, or you want to cancel the home area code you have already programmed, reprogram your home area code to **000**.

Telephone settings

Language

1. Press **PROG** when the handset is in idle mode.
2. Press ▼ or ▲ until **LANGUAGE** is displayed.
3. Press **SELECT**. The current setting flashes.
4. Press ▼ or ▲ until the screen displays the desired language (**ENGLISH, ESPANOL** or **FRANCAIS**).
5. Press **SELECT** to confirm your selection. You will hear a confirmation tone.

Telephone settings

Clear voicemail

If you subscribe to voicemail services provided by your telephone company, **NEW VOICEMAIL** will be displayed on the handset when you have new voicemail messages. Please contact your local telephone company for more information about voicemail service.

After reviewing all new messages, the **NEW VOICEMAIL** indicator will be turned off. However, if the indicator remains on after you have listened to all new voicemail messages, follow these steps to manually turn off the indicator:

1. Press **PROG** when the handset is in idle mode.
2. Press ▼ or ▲ until the screen displays **CLR VOICEMAIL**, then press **SELECT**.
- OR -
Press #.
3. The screen displays **CLEAR?** and the current setting flashes.
4. Press ▼ or ▲ to select **YES**.
5. Press **SELECT** to confirm your selection. You will hear a confirmation tone.

note

- The clear voicemail feature only removes the display **NEW VOICEMAIL** on the handset. It does not delete your voicemail message(s).

note

- The call timer will be activated during a call to show call duration.

Telephone operation

Make calls

- Press **TALK/FLASH** and then use the dial pad keys to dial a number.
-OR-
 1. Enter the phone number first. Press ▼ to backspace and erase digits.
 2. Press **TALK/FLASH** to dial.

Answer calls

- Press any dial pad keys (except ▼/VOL-/CID, ▲/VOL+/ and OFF) to answer an incoming call.

End calls

- Press OFF or put the handset back in the telephone base to end a call.

Volume

- Press ▼/VOL-/CID or ▲/VOL+/ to adjust the listening volume during a conversation.

Channel

- Press CHAN/DELETE to switch to a clearer channel while on a call.

Telephone operation

Call waiting

If you subscribe to call waiting service and you are on a call when a new call comes in, you will hear a beep. The caller ID information will be displayed if you subscribe to combined caller ID with call waiting service from your local telephone company.

- Press **TALK/FLASH** on the handset to put the current call on hold and answer the incoming call.
- Press **TALK/FLASH** at anytime to alternate between calls.

Temporary tone dialing

If you have pulse (rotary) service, you can change from pulse to touch tone dialing during a call by pressing **TONE***. This is useful if you need to send touch tone signals to access telephone banking or long distance services.

Once you have initiated your call by dialing the phone number in pulse (rotary), press **TONE***. Now, all subsequent key presses will be sent as touch tone signals.

After you hang up, the phone will return to pulse (rotary) dialing for the next call.

Telephone operation

Redial

- The telephone stores the five most recently dialed telephone numbers on the redial list. When the list is full, the oldest entry is deleted to make room for the new entry.
 - Press **REDIAL/PAUSE** repeatedly to review the redial list. Press **CHAN/DELETE** to delete the displayed number.
 - Press **TALK/FLASH**, then press **REDIAL/PAUSE** to dial the last telephone number dialed.
- OR-**
Press **REDIAL/PAUSE** repeatedly until the desired entry displays, then press **TALK/FLASH** to dial the number.

Find handset

- Press **FIND HANDSET** on the telephone base to locate the handset when the telephone is not in use. The handset will ring and ****PAGING**** will be displayed on its screen.
 - Press **FIND HANDSET** again or put the handset back in the telephone base to stop the paging tone.
- OR-**
Press **OFF** on the handset.

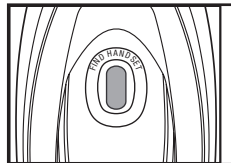

Telephone operation

Directory

The directory can store up to 10 entries (including nine speed dial entries). Each entry may consist of a number up to 24 digits and a name up to 14 characters.

Store a directory entry

1. Press **PROG** when in idle mode. The screen displays **DIRECTORY**.
2. Press **SELECT**. The screen displays **ENTER NAME**.
3. Use the dial pad keys to enter the name. See the **Character chart** on page 16.
 - Press ▼ to backspace and erase.
 - Press ▲ to advance.
4. When finished, press **SELECT** or **PROG**. The screen displays **ENTER NUMBER**.
5. Use the dial pad keys to enter the telephone number.
 - Press ▼ to backspace and erase.
 - Press **REDIAL/PAUSE** to insert a dialing pause (**P** will be displayed).
6. Press **SELECT** or **PROG**. The screen displays **DISTINCT RING?** and the current setting.
7. Press ▼ or ▲ to choose **Y** (yes) if you wish to customize this entry or choose **N** (no) for a normal ringer. If you choose **Y**, a  will be displayed with the directory entry.
8. Press **SELECT** or **PROG** to confirm and you will hear a confirmation tone.

note

- When you reach the end of the list in the directory, **END OF LIST** will be shown on the screen and there will be a double beep.
- If you press a dial pad key for alphabetical search while in the directory and there are no entries starting with the letters of that key, **NO DATA** will be displayed on the screen.

Telephone operation

Character chart

Use the dial pad keys and the chart below to enter a name (up to 14 characters). An error tone will sound if you try to enter more than 14 characters. Each press of a particular key causes the characters to be displayed in the following order:

Dial key	Characters by number of key presses					
	1	2	3	4	5	6
1	1					
2	A	B	C	2		
3	D	E	F	3		
4	G	H	I	4		
5	J	K	L	5		
6	M	N	O	6		
7	P	Q	R	S	7	
8	T	U	V	8		
9	W	X	Y	Z	9	
0	0					
*	*					
#	&	'	,	-	.	#

Telephone operation

Review the directory



1. Press ▲/VOL+/📖 when in idle mode. The screen displays **DIRECTORY**.
2. Press ▼ or ▲ to scroll through the entries stored in the directory alphabetically.

- OR -

Press the dial pad key for the first letter of the name you want to search. If necessary, scroll ▼ or ▲ to find the desired entry.

Telephone operation

Edit a directory entry

1. Press **▲/VOL+/** when in idle mode. The screen displays **DIRECTORY**.
2. Press **▼** or **▲** to scroll through the entries stored in the directory alphabetically.
- OR -
Press the dial pad key for the first letter of the entry you want to edit. If necessary, scroll **▼** or **▲** to find the desired entry.
3. When the screen displays the desired entry, press **SELECT**. Then press **▼** or **▲** until **EDIT** flashes.
4. Press **SELECT**. The screen displays the name and number.
The cursor appears at the end of the name.
 - Use the dial pad keys to edit the name.
 - Press **▼** to backspace and erase.
 - Press **▲** to advance.
5. Press **SELECT** to move on to the phone number.
 - Use the dial pad keys to edit the number.
 - Press **▼** to backspace and erase.
 - Press **REDIAL/PAUSE** to insert a dialing pause (**P** will be displayed).
6. Press **SELECT**. The screen displays **DISTINCT RING?** and the current setting.
7. Press **▼** or **▲** to choose **Y** (yes) if you wish to customize this entry, or choose **N** (no) for a normal ringer. If you choose **Y**, a  will be displayed with the directory entry.
8. Press **SELECT** to confirm and you will hear a confirmation tone.

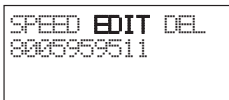

Telephone operation

Delete a directory entry

1. Press **▲/VOL+**/ when in idle mode. The screen displays **DIRECTORY**.
2. Press **▼** or **▲** to scroll through the entries stored in the directory alphabetically.
- OR -
Press the dial pad key for the first letter of the entry you want to delete. If necessary, scroll **▼** or **▲** to find the desired entry.
3. When the screen displays the desired entry, press **SELECT**. Then press **▼** or **▲** until **DEL** (delete) flashes.
4. Press **SELECT**. The screen displays **ERASE NO YES** and the number. The current choice flashes.
5. Press **▲** until **YES** flashes.
6. Press **SELECT**. You will hear a confirmation beep.

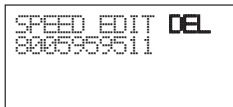

Telephone operation

Copy a directory entry into speed dial

1. Press **▲/VOL+/** when in idle mode. The screen displays **DIRECTORY**.
2. Press **▼** or **▲** to scroll through the entries stored in the directory alphabetically.
- OR -
Press the dial pad key for the first letter of the entry you want to copy. If necessary, scroll **▼** or **▲** to find the desired entry.
3. When the screen displays the desired entry, press **SELECT**.
Then press **▼** or **▲** until **SPEED** flashes.
4. Press **SELECT**. The screen displays **ENTER 1-9**.
5. Press a key (1-9) to copy this entry from the directory to the speed dial memory and assign the memory location. You will hear a confirmation beep. A memory location number (01 through 09) will be displayed with this entry.



Dial a number from the directory

1. Press **▲/VOL+/** when in idle mode. The screen displays **DIRECTORY**.
2. Press **▼** or **▲** to scroll through the entries stored in the directory alphabetically.
- OR -
Press the dial pad key for the first letter of the desired entry. If necessary, scroll **▼** or **▲** to find the desired entry.
3. When the screen displays the desired entry, press **TALK/FLASH**.

Telephone operation

Speed dial

Your telephone can store up to nine telephone numbers with names (up to 14 characters and 24 digits in each location) in designated speed dial memory locations.

Store a speed dial entry

1. Press **PROG** when the handset is in idle mode and then press ▼ or ▲ until the screen displays **SPEED DIAL**.
2. Press **SELECT**. The screen displays **ENTER 1-9**.
3. Press a key (**1** through **9**) to assign the speed dial location where this number will be stored. The screen displays **ENTER NAME**.
4. Use the dial pad keys to enter the name (see the **Character chart** on page 16) and then press **SELECT** or **PROG**.
 - Press ▼ to backspace and erase.
 - Press ▲ to advance.
5. The screen displays **ENTER NUMBER**.
6. Use the dial pad keys to enter the telephone number, and then press **SELECT** or **PROG**.
 - Press ▼ to backspace and erase.
 - Press **REDIAL/PAUSE** to insert a dialing pause (**P** will be displayed).
7. The screen displays **DISTINCT RING?** and the current setting.

note

- The entries stored in the speed dial memory will be numbered 01 through 09 and share the memory in the directory.
- Press **OFF** at any time to exit speed dial mode.
- If the location is not empty, the new entry will replace the old entry and the old entry will be moved to a directory location.

Telephone operation

8. Press ▼ or ▲ to choose **Y** (yes) if you wish to customize this entry, or choose **N** (no) for a normal ringer. If you choose **Y**, a  will be displayed with the entry
9. Press **SELECT** or **PROG** to confirm. You will hear a confirmation tone.

Edit a speed dial entry

1. Press and hold the speed dial location key (**1-9**) of the desired entry when the handset is in idle mode.
2. When the screen displays the entry you want to edit, press **SELECT**. Then press ▼ or ▲ until **EDIT** flashes.
3. Press **SELECT**. The screen displays the name and number. The cursor appears at the end of the name. Use the dial pad keys to edit the name.
 - Press ▼ to backspace and erase.
 - Press ▲ to advance.
4. Press **SELECT** to move on to the phone number. Use the dial pad keys to edit the number.
 - Press ▼ to backspace and erase.
 - Press **REDIAL/PAUSE** to insert a dialing pause (**P** will be displayed).
5. Press **SELECT**. The screen displays **DISTINCT RING?** and the current setting.



Telephone operation

6. Press ▼ or ▲ to choose **Y** (yes) if you wish to customize this entry, or choose **N** (no) for a normal ringer. If you choose **Y**, a  will be displayed with the directory entry.
7. Press **SELECT** to confirm. You will hear a confirmation tone.

Delete a speed dial entry

1. Press and hold the speed dial location key (**1-9**) of the desired entry when the handset is in idle mode.
2. When the screen displays the desired entry, press **SELECT**. Then press ▼ or ▲ until **DEL** (delete) flashes.
3. Press **SELECT**. The screen displays **ERASE NO YES** and the number. The current choice flashes.
4. Press ▲ until **YES** flashes.
5. Press **SELECT**. You will hear a confirmation beep.



Dial a speed dial number

1. Press and hold a speed dial location key (**1-9**) representing the desired entry when the handset is in idle mode.
2. Press /FLASH to dial the displayed number.

Telephone operation

Reassign speed dial locations

1. Press and hold the speed dial location key (**1-9**) of the desired entry when the handset is in idle mode.
2. When the screen displays the desired entry, press **SELECT**. Press ▼ or ▲ until **SPEED** flashes.
3. Press **SELECT**. The screen displays **ENTER 1-9**.
4. Press a key (**1-9**) to reassign this entry into another speed dial location. You will hear a confirmation beep.



Telephone operation

About caller ID

The caller ID with call waiting feature in this telephone lets you see the name and telephone number of the caller before answering the call, even while you are on a call. These features require services provided by your local telephone company.

Contact your telephone company if:

- you have both caller ID and call waiting, but as separate services (you may need combined service),
- you have only caller ID service, or only call waiting service, or
- you do not subscribe to any caller ID or call waiting services but wish to try them.

You can use this telephone with regular caller ID service, and you can use its other features without subscribing to either caller ID or combined caller ID with call waiting service. There may be fees for these services, and they may not be available in all areas.

The caller ID features will work only if both you and the caller are in areas offering caller ID service, and if both telephone companies use compatible equipment.

note

- If you answer a call before the information appears on the screen, it will not be stored in the call log.
- The time on the handset screen is automatically set and updated with incoming caller ID information if you subscribe to this service.
- Due to regional service differences, the caller ID information may not be available for every incoming call. In addition, the callers may intentionally block their names and/or telephone numbers.

Telephone operation

Call log

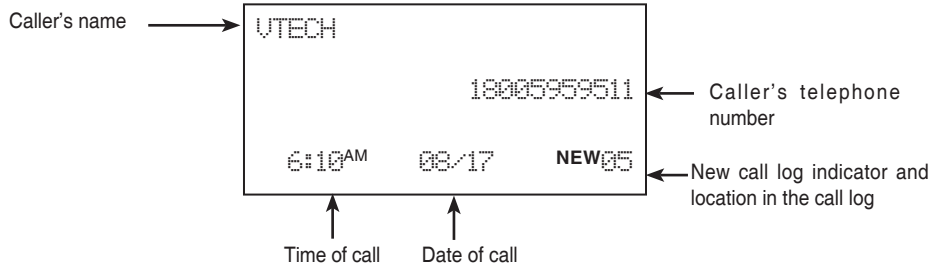

If you subscribe to caller ID service, information about each caller will be displayed after the first or second ring.

- The call log can store up to 30 entries.
- When the call log is full, the earliest entry will be deleted to make room for new incoming call information.
- **CID EMPTY** will be displayed if there is no record in the call log.

Telephone operation

Review the call log

1. Press ▼/VOL-/CID to view the call log when the handset is in idle mode.
2. Press ▼ or ▲ to scroll through the entries.

There will be an error tone when you reach the end of the call log list and the screen will display **END OF LIST**.

Make a call log entry ready to dial

Although the call log entries received have 10 digits (the area code plus the seven-digit number), in some areas, you may need to dial only seven digits, or a 1 plus the seven digits, or a 1 plus the area code plus the seven digits. You can change the number of digits that you dial or store from the call log.

While reviewing the call log, press # repeatedly to display these dialing options for local and long distance numbers before dialing or saving the telephone number. See the example on the right.

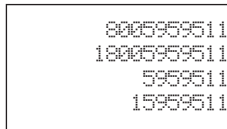

```
8005959511
18005959511
5959511
15959511
```

note

- If you have programmed a home area code (page 9), only the last seven digits of the incoming phone numbers from that area code will be displayed or dialed. Press # repeatedly to display all possible dialing options.

Telephone operation

Dial a call log number

1. Press ▼/**VOL-/CID** to enter the call log when the handset is in idle mode.
2. Press ▼ or ▲ to select the desired entry, then press /**FLASH**.

-OR-

1. Press ▼/**VOL-/CID** to enter the call log when the handset is in idle mode.
2. Press ▼ or ▲ to select the desired entry.
3. Press **SELECT**. **DIAL** flashes.
4. Press **SELECT** to dial.

Telephone operation

Save a call log entry to the directory

1. Press **▼/VOL-/CID** to enter the call log when the handset is in idle mode.
2. Press **▼** or **▲** to select the desired entry. If you wish to change how the number is saved, press **#** repeatedly until the desired option displays. See the **Make a call log entry ready to dial** section on page 27.
3. Press **SELECT**, then press **▼** or **▲** until **PROGRAM** flashes.
4. Press **SELECT** again.
5. Enter or edit the name if necessary. See the **Character chart** on page 15.
 - Press **▼** to backspace and erase.
 - Press **▲** to advance.Press **SELECT** to move on to the phone number.
6. Edit the number if necessary.
 - Press **▼** to backspace and erase.
 - Press **REDIAL/PAUSE** to insert a dialing pause (**P** will be displayed). Press **SELECT** to continue.
7. Press **▼** or **▲** to choose **Y** (yes) if you wish to customize this entry, or choose **N** (no) for a normal ringer. If you choose **Y**, a  will be displayed with the directory entry.
8. Press **SELECT** to confirm. You will hear a confirmation tone.

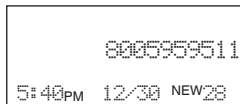

8005959511
5:40PM 12/30 NEW28

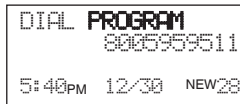

DIAL PROGRAM
8005959511
5:40PM 12/30 NEW28



DISTINCT RING? N
8005959511

Telephone operation

Delete from the call log

Delete an entry:

1. Press **▼/VOL-/CID** to enter the call log when the handset is in idle mode.
2. Press **▼** or **▲** to select the entry to be deleted.
3. Press **CHAN/DELETE**. You will hear a confirmation beep.

Delete all entries:

1. Press and hold **CHAN/DELETE** when the handset is in idle mode. The screen displays **ERASE ALL N Y**. The current choice flashes.
2. Press **▲** until **Y** (yes) flashes.
3. Press **SELECT**. You will hear a confirmation beep.

Telephone operation

Call log display screen messages

Displays:	When:
PRIVATE NAME	The caller is blocking the name information.
PRIVATE NUMBER	The caller is blocking the telephone number information.
PRIVATE CALLER	The caller is blocking the name and number information.
UNKNOWN NAME	This caller's name is unavailable.
UNKNOWN NUMBER	This caller's number is unavailable.
UNKNOWN CALLER	No call information is available about this caller.

Handset display screen messages

Displays:	When:
LOW BATTERY	The battery needs to be recharged.
CHARGING...	The handset is in the telephone base and charging.
CID EMPTY	There are no call log entries.
CONNECTING...	The cordless handset is searching for the telephone base.
DIRECTORY EMPTY	There are no directory entries.
MEMORY FULL	The directory is full.
XX MISSED CALLS	There are unreviewed calls in the call log.
NEW VOICEMAIL	There are new voice mail message(s) from the local telephone company.
PAGING	The cordless handset locator has been activated.
PHONE	The handset is in use.
REDIAL EMPTY	There are no phone numbers in redial memory.
RINGING	There is an incoming call.
RINGER OFF	The handset ringer is turned off.
SCANNING...	The telephone base is searching for another available channel.

Battery

After the battery is fully charged for 16 hours, you can expect the following performance:

Operation	Operating time
While in use (talking)	3.5 hours
While not in use (standby*)	3.5 days

*Handset is off the telephone base but not in use.

The battery needs charging when:

- A new battery is installed in the handset.
- The handset beeps.
- **LOW BATTERY** and the battery low indicator  are displayed on the handset screen.

CAUTION:

To reduce the risk of fire or injury, read and follow these instructions:

- Use only the battery provided or equivalent. To order a replacement, visit our website at www.vtechphones.com or call 1 (800) 595-9511. In Canada, go to www.vtechcanada.com or call 1 (800) 267-7377.
- Do not dispose of the battery(ies) in a fire. Check with local waste management codes for special disposal instructions.
- Do not open or mutilate the battery(ies). Released electrolyte is corrosive and may cause burns or injury to the eyes or skin. The electrolyte may be toxic if swallowed.
- Exercise care in handling batteries in order not to create a short circuit with conductive materials such as rings, bracelets, and keys. The battery and/or conductor may overheat and cause burns.
- Charge the battery provided with or identified for use with this product only in accordance with the instructions and limitations specified in this manual.

WARNING:

TO PREVENT FIRE OR SHOCK HAZARD, DO NOT EXPOSE THIS PRODUCT TO WATER OR ANY TYPE OF MOISTURE.

www.vtechphones.com

Important safety instructions

When using your telephone equipment, basic safety precautions should always be followed to reduce the risk of fire, electric shock and injury, including the following:

1. Read and understand all instructions.
2. Follow all warnings and instructions marked on the product.
3. Unplug this product from the wall outlet before cleaning. Do not use liquid or aerosol cleaners. Use a damp cloth for cleaning.
4. Do not use this product near water (for example, near a bathtub, kitchen sink, or swimming pool).
5. Do not place this product on an unstable table, shelf, stand or other unstable surfaces.
6. Slots and openings in the back or bottom of the telephone base and handset are provided for ventilation. To protect them from overheating, these openings must not be blocked by placing the product on a soft surface such as a bed, sofa or rug. This product should never be placed near or over a radiator or heat register. This product should not be placed in any area where proper ventilation is not provided.
7. This product should be operated only from the type of power source indicated on the marking label. If you are not sure of the type of power supply in your home, consult your dealer or local power company.
8. Do not allow anything to rest on the power cord. Do not install this product where the cord may be walked on.
9. Never push objects of any kind into this product through the slots in the telephone base or handset because they may touch dangerous voltage points or create a short circuit. Never spill liquid of any kind on the product.
10. To reduce the risk of electric shock, do not disassemble this product, but take it to an authorized service facility. Opening or removing parts of the telephone base or handset other than specified access doors may expose you to dangerous voltages or other risks. Incorrect reassembling can cause electric shock when the product is subsequently used.
11. Do not overload wall outlets and extension cords.
12. Unplug this product from the wall outlet and refer servicing to an authorized service facility under the following conditions:
 - A. When the power supply cord or plug is damaged or frayed.
 - B. If liquid has been spilled onto the product.
 - C. If the product has been exposed to rain or water.
 - D. If the product does not operate normally by following the operating instructions. Adjust only those controls that are covered by the operation instructions. Improper adjustment of other controls may result in damage and often requires extensive work by an authorized technician to restore the product to normal operation.
 - E. If the product has been dropped and the telephone base and/or handset has been damaged.
 - F. If the product exhibits a distinct change in performance.
13. Avoid using a telephone (other than cordless) during an electrical storm. There is a remote risk of electric shock from lightning.
14. Do not use the telephone to report a gas leak in the vicinity of the leak.
15. Only put the handset of your telephone next to your ear when it is in normal talk mode.
16. The power adapter is intended to be correctly oriented in a vertical or floor mount position. The prongs are not designed to hold the plug in place if it is plugged into a ceiling or an under-the-table/cabinet outlet.

SAVE THESE INSTRUCTIONS
www.vtechphones.com

Troubleshooting

If you have difficulty with your telephone, please try the suggestions below. For Customer Service, visit our website at www.vtechphones.com, or call 1 (800) 595-9511; in Canada, call 1 (800) 267-7377.

Problem	Suggestion
My telephone does not work at all.	<ul style="list-style-type: none">• Make sure the battery is installed and charged correctly (page 3). For optimum daily performance, return the handset to the telephone base after use.• Make sure the power adapter is securely plugged into an outlet not controlled by a wall switch.• Make sure the telephone line cord is plugged firmly into the telephone base and the wall jack.• Unplug the unit's electrical power. Wait for approximately 15 seconds, then plug it back in. Allow up to one minute for the handset and telephone base to synchronize.• Charge the battery in the handset for at least 16 hours.• Remove and re-insert the battery. If that still does not work, it may be necessary to purchase a new battery.• Disconnect the telephone base from the jack and plug in a working telephone. If this telephone does not work, the problem is probably in the wiring or the local service. Call the local telephone company.
LOW BATTERY is displayed on screen.	<ul style="list-style-type: none">• Place the handset in the telephone base for recharging.• Remove and re-install the battery and use it normally until fully depleted, then recharge the handset in the telephone base for 16 hours.• If the above measures do not correct the problem, the battery may need to be replaced.

Troubleshooting

Problem	Suggestion
The battery does not charge in the handset or the handset battery does not accept charge.	<ul style="list-style-type: none">• Make sure the handset is placed in the telephone base correctly.• Remove the battery from the handset and then re-install it in the handset. Put the handset back to the telephone base and charge for 16 hours.• It may be necessary to purchase a new battery. Please see the Battery section of this user's manual (page 33).• The telephone might be malfunctioning. Please see the Warranty section of this user's manual (page 45) for further instruction.
There is no dial tone.	<ul style="list-style-type: none">• First, try all the above suggestions.• Move the handset closer to the telephone base. It might be out of range.• The telephone line cord might be malfunctioning. Try installing a new telephone line cord.• Disconnect the telephone base from the telephone jack and connect a different telephone. If there is no dial tone on the other telephone either, the problem is in your wiring or local service. Contact your local telephone company.
My handset displays CONNECTING...	<ul style="list-style-type: none">• Move the handset closer to the telephone base. You might have moved out of range.

Troubleshooting

Problem	Suggestion
The telephone does not ring when there is an incoming call.	<ul style="list-style-type: none">• Make sure the ringer is on (page 8).• Make sure the telephone line cord and power adapter are plugged in properly (page 2).• The handset may be too far from the telephone base. Move it closer to the telephone base.• There may be too many extension telephones on the telephone line to allow all of them to ring simultaneously. Try unplugging some of them.• If the other telephones in your home are having the same problem, the problem is in the wiring or local service. Contact the local telephone company (charges may apply).• Other electronic products can cause interference to your cordless telephone. Try installing your telephone as far away as possible from the following electronic devices: wireless routers, radios, radio towers, pager towers, cellular telephones, digital telephones, intercoms, room monitors, televisions, VCRs, personal computers, kitchen appliances, and other cordless telephones.• Test a working telephone at the telephone jack. If another telephone has the same problem, the problem is in the telephone jack. Contact your local telephone company (charges may apply).• The telephone line cord might be malfunctioning. Try installing a new telephone line cord.• Remove and re-insert the battery and place the handset in the telephone base.• Wait for the handset to synchronize with the telephone base. Allow up to one minute for this to take place.

Troubleshooting

Problem	Suggestion
I cannot dial out.	<ul style="list-style-type: none">• First, try all the above suggestions.• Make sure there is a dial tone before dialing. It is normal if the handset takes a second or two to synchronize with the telephone base before producing a dial tone. Wait an extra second before dialing.• Make sure the telephone is set to the correct dial type (pulse dial or tone dial) for the service in your area. See Dial mode on page 9 to set the dial type.• If the other telephones in your home are having the same problem, the problem is in the wiring or local service. Contact your local telephone company (charges may apply).• Eliminate any background noise. Noise from a television, radio, or other appliances may cause the telephone not to dial out properly. If you cannot eliminate the background noise, first try muting the handset before dialing, or dialing from another room in your home with less background noise.

Troubleshooting

Problem	Suggestion
<p>There is noise or interference during a telephone conversation.</p> <p>My calls cut in and out when I am using the cordless handset.</p>	<ul style="list-style-type: none">• The handset may be out of range. Move it closer to the telephone base.• Appliances or other cordless telephones plugged into the same circuit as the telephone base can cause interference. Try moving the appliance or telephone base to another outlet.• Other electronic products can cause interference to your cordless telephone. Try installing your telephone as far away as possible from the following electronic devices: wireless routers, radios, radio towers, pager towers, cellular telephones, digital telephones, intercoms, room monitors, televisions, VCRs, personal computers, kitchen appliances, and other cordless telephones.• If your telephone is plugged in with a modem or a surge protector, plug the telephone (or modem/surge protector) into a different location. If this solves the problem, re-locate your telephone or modem farther apart from each other, or use a different surge protector.• The layout of your home or office might be limiting the operating range. Try moving the telephone base to another location, preferably a higher location for better reception.• Disconnect the telephone base from the telephone jack and plug in a corded telephone. If calls are still not clear, the problem is probably in the wiring or local service. Contact the local telephone company (charges may apply).• If the other telephones in your home are having the same problem, the problem is in the wiring or local service. Contact the local telephone company (charges may apply).• Do you have DSL service? If yes, you need to have a DSL filter installed at every telephone jack that has a telephone connected to it. Contact your DSL service provider for filter information.

Troubleshooting

Problem	Suggestion
I hear other calls when using the telephone.	<ul style="list-style-type: none">• Disconnect the telephone base from the telephone jack. Plug in a different telephone. If there are still other calls, the problem is probably in the wiring or local service. Call your local telephone company.• Press CHAN/DELETE to switch to a clearer channel when on a call.
I hear noise in the handset, and none of the keys or buttons work.	<ul style="list-style-type: none">• Make sure the telephone line cord is plugged in securely.• Remove and re-insert the battery.

Troubleshooting

Problem	Suggestion
My caller ID features are not working properly.	<ul style="list-style-type: none">• Caller ID is a subscription service. You must subscribe to this service from your local telephone company for this feature to work on your telephone.• The caller may not be calling from an area which supports caller ID.• Both you and the caller's telephone companies must use equipment which are compatible with caller ID service.• If you subscribe to DSL service, install a DSL filter to the telephone line between the telephone base and the telephone line jack. Contact your DSL service provider for filter information.
The system does not receive caller ID, or the system does not display caller ID during call waiting.	<ul style="list-style-type: none">• Make sure you subscribe to caller ID with call waiting features provided by the local telephone company.• The caller may not be calling from an area which supports caller ID.• Both you and the caller's telephone companies must use equipment which are compatible with caller ID service.• If you subscribe to DSL service, install a DSL filter to the telephone line between the telephone base and the telephone line jack. Contact your DSL service provider for filter information.

Troubleshooting

Problem	Suggestion
Caller ID entries do not match the numbers I need to dial.	<ul style="list-style-type: none">• Although the call log entries you receive have 10 digits, (the area code plus the seven-digit number), in some areas, you may need to dial only seven digits, or a 1 plus the seven digits, or a 1 plus the area code plus the seven digits. You can change the number of digits that you dial or store from the call log.• While reviewing the call log, press # repeatedly to display these dialing options for local and long distance numbers before dialing or saving the telephone number.
My cordless handset beeps and is not performing normally.	<ul style="list-style-type: none">• Make sure the power cord is securely plugged into the telephone base. Plug the unit into a different working electrical outlet not controlled by a wall switch.• Move the handset closer to the telephone base. It may be out of range.• Remove and re-insert the battery.• Reset the telephone base by unplugging the unit's electrical power. Wait for 15 seconds and plug it back in again. Allow up to one minute for the handset and the telephone base to synchronize.• Other electronic products can cause interference to your cordless telephone. Try installing your telephone as far away from these electronic devices as possible: wireless routers, radios, radio towers, pager towers, cellular telephones, intercoms, room monitors, televisions, personal computers, kitchen appliances and other cordless telephones.



Troubleshooting

Problem	Suggestion
Common cure for electronic equipment	<ul style="list-style-type: none">• If the unit is not responding normally, try putting the handset in the telephone base. If it does not respond, try the following (in the order listed):• Disconnect the power to the telephone base.• Disconnect the battery on the handset.• Wait a few minutes before connecting the power to the telephone base.• Re-install the battery and place the handset in the telephone base.• Wait for the handset to synchronize with the telephone base. Allow up to one minute for this to take place.

Operating range

This cordless telephone operates with the maximum power allowed by the Federal Communications Commission (FCC). Even so, this handset and telephone base can communicate over only a certain distance - which can vary with the locations of the telephone base and handset, the weather, and the layout of your home or office.

When the handset is out of range, the handset will display **CONNECTING...**

If there is a call while the handset is out of range, it might not ring; or if it does ring, the call might not connect well when you press **TALK**  **FLASH**. Move closer to the telephone base, then press **TALK**  **FLASH** to answer the call.

If the handset moves out of range during a telephone conversation, there might be interference.

To improve reception, move closer to the telephone base.

Maintenance

Taking care of your telephone

Your cordless telephone contains sophisticated electronic parts, so it must be treated with care.

Avoid rough treatment

Place the handset down gently. Save the original packing materials to protect your telephone if you ever need to ship it.

Avoid water

Your telephone can be damaged if it gets wet. Do not use the handset outdoors in the rain, or handle it with wet hands. Do not install the telephone base near a sink, bathtub or shower.

Electrical storms

Electrical storms can sometimes cause power surges harmful to electronic equipment. For your own safety, take caution when using electrical appliances during storms.

Cleaning your telephone

Your telephone has a durable plastic casing that should retain its luster for many years. Clean it only with a soft cloth slightly dampened with water or a mild soap. Do not use excess water or cleaning solvents of any kind.

Remember that electrical appliances can cause serious injury if used when you are wet or standing in the water. If the telephone base should fall into the water, **DO NOT RETRIEVE IT UNTIL YOU UNPLUG THE POWER CORD AND TELEPHONE LINE CORD FROM THE WALL**. Then pull the unit out by the unplugged cords.

About cordless telephones

- **Privacy:** The same features that make a cordless telephone convenient create some limitations. Telephone calls are transmitted between the telephone base and the cordless handset by radio waves, so there is a possibility that the cordless telephone conversations could be intercepted by radio receiving equipment within range of the cordless handset. For this reason, you should not think of cordless telephone conversations as being as private as those on corded telephones.
- **Electrical Power:** The telephone base of this cordless telephone must be connected to a working electrical outlet. The electrical outlet should not be controlled by a wall switch. Calls cannot be made from the cordless handset if the telephone base is unplugged or switched off, or if the electrical power is interrupted.
- **Potential TV interference:** Some cordless telephones operate at frequencies that may cause interference to televisions and VCRs. To minimize or prevent such interference, do not place the telephone base of the cordless telephone near or on top of a TV or VCR. If interference is experienced, moving the cordless telephone farther away from the TV or VCR will often reduce or eliminate the interference.
- **Rechargeable batteries:** This product contains either nickel-cadmium or nickel-metal-hydride rechargeable batteries. Exercise care in handling batteries in order not to create a short circuit with conducting material such as rings, bracelets, and keys. The battery or conductor may overheat and cause harm. Observe proper polarity between the battery and the battery charger.
- **Nickel-cadmium rechargeable batteries:** Dispose of these batteries in a safe manner. Do not burn or puncture the battery. Like other batteries of this type, if burned or punctured, they could release caustic material which could cause injury.

Warranty

What does this limited warranty cover?

The manufacturer of this VTech Product warrants to the holder of a valid proof of purchase (“Consumer” or “you”) that the Product and all accessories provided in the sales package (“Product”) are free from defects in material and workmanship, pursuant to the following terms and conditions, when installed and used normally and in accordance with the Product operating instructions. This limited warranty extends only to the Consumer for Products purchased and used in the United States of America and Canada.

What will VTech do if the Product is not free from defects in materials and workmanship during the limited warranty period (“Materially Defective Product”)?

During the limited warranty period, VTech’s authorized service representative will repair or replace at VTech’s option, without charge, a Materially Defective Product. If we repair the Product, we may use new or refurbished replacement parts. If we choose to replace the Product, we may replace it with a new or refurbished Product of the same or similar design. We will retain defective parts, modules, or equipment. Repair or replacement of the Product, at VTech’s option, is your exclusive remedy. VTech will return the repaired or replacement Products to you in working condition. You should expect the repair or replacement to take approximately 30 days.

How long is the limited warranty period?

The limited warranty period for the Product extends for ONE (1) YEAR from the date of purchase. If VTech repairs or replaces a Materially Defective Product under the terms of this limited warranty, this limited warranty also applies to the repaired or replacement Product for a period of either (a) 90 days from the date the repaired or replacement Product is shipped to you or (b) the time remaining on the original one-year warranty; whichever is longer.

What is not covered by this limited warranty?

This limited warranty does not cover:

1. Product that has been subjected to misuse, accident, shipping or other physical damage, improper installation, abnormal operation or handling, neglect, inundation, fire, water or other liquid intrusion; or

Warranty

2. Product that has been damaged due to repair, alteration or modification by anyone other than an authorized service representative of VTech; or
3. Product to the extent that the problem experienced is caused by signal conditions, network reliability, or cable or antenna systems; or
4. Product to the extent that the problem is caused by use with non-VTech accessories; or
5. Product whose warranty/quality stickers, product serial number plates or electronic serial numbers have been removed, altered or rendered illegible; or
6. Product purchased, used, serviced, or shipped for repair from outside the United States of America or Canada, or used for commercial or institutional purposes (including but not limited to Products used for rental purposes); or
7. Product returned without a valid proof of purchase (see item 2 below); or
8. Charges for installation or set up, adjustment of customer controls, and installation or repair of systems outside the unit.

How do you get warranty service?

To obtain warranty service in the United States of America, please call 1 (800) 595-9511. In Canada, please call 1 (800) 267-7377. NOTE: Before calling for service, please review the user's manual - a check of the Product's controls and features may save you a service call.

Except as provided by the applicable law, you assume the risk of loss or damage during transit and transportation and are responsible for delivery or handling charges incurred in the transport of the Product(s) to the service location. VTech will return the repaired or replaced Product under this limited warranty to you, transportation, delivery or handling charges prepaid. VTech assumes no risk for damage or loss of the Product in transit. If the Product failure is not covered by this limited warranty, or proof of purchase does not meet the terms of this limited warranty, VTech will notify you and will request that you authorize the cost of repair prior to any further repair activity. You must pay for the cost of repair and return shipping costs for the repair of Products that are not covered by this limited warranty.

What must you return with the Product to get warranty service?

1. Return the entire original package and contents including the Product to the VTech service location along with a description of the malfunction or difficulty; and
2. Include a "valid proof of purchase" (sales receipt) identifying the Product purchased (Product model) and the date of purchase or receipt; and
3. Provide your name, complete and correct mailing address, and telephone number.

Other Limitations

This warranty is the complete and exclusive agreement between you and VTech. It supersedes all other written or oral communications related to this Product. VTech provides no other warranties for this Product. The warranty exclusively describes all of VTech's responsibilities regarding the Product. There are no other express warranties. No one is authorized to make modifications to this limited warranty and you should not rely on any such modification.

State/Provincial Law Rights: This warranty gives you specific legal rights, and you may also have other rights, which vary from state to state or province to province.

Limitations: Implied warranties, including those of fitness for a particular purpose and merchantability (an unwritten warranty that the Product is fit for ordinary use) are limited to one year from the date of purchase. Some states/provinces do not allow limitations on how long an implied warranty lasts, so the above limitation may not apply to you. In no event shall VTech be liable for any indirect, special, incidental, consequential, or similar damages (including, but not limited to lost profits or revenue, inability to use the Product or other associated equipment, the cost of substitute equipment, and claims by third parties) resulting from the use of this Product. Some states/provinces do not allow the exclusion or limitation of incidental or consequential damages, so the above limitation or exclusion may not apply to you.

Please retain your original sales receipt as proof of purchase.

FCC, ACTA and IC regulations

FCC Part 15

This equipment has been tested and found to comply with the requirements for a Class B digital device under Part 15 of the Federal Communications Commission (FCC) rules. These requirements are intended to provide reasonable protection against harmful interference in a residential installation. This equipment generates, uses and can radiate radio frequency energy and, if not installed and used in accordance with the instructions, may cause harmful interference to radio communications. However, there is no guarantee that interference will not occur in a particular installation. If this equipment does cause harmful interference to radio or television reception, which can be determined **by turning the equipment off and on, the user is encouraged to try to correct the interference by one or more of the following measures:**

- Reorient or relocate the receiving antenna.
- Increase the separation between the equipment and receiver.
- Connect the equipment into an outlet on a circuit different from that to which the receiver is connected.
- Consult the dealer or an experienced radio/TV technician for help.

Changes or modifications to this equipment not expressly approved by the party responsible for compliance could void the user's authority to operate the equipment.

This device complies with Part 15 of the FCC rules. Operation is subject to the following two conditions: (1) this device may not cause harmful interference, and (2) this device must accept any interference received, including interference that may cause undesired operation. Privacy of communications may not be ensured when using this telephone.

To ensure safety of users, the FCC has established criteria for the amount of radio frequency energy that can be safely absorbed by a user or bystander according to the intended usage of the product. This product has been tested and found to comply with the FCC criteria. The handset may be safely held against the ear of the user. The telephone base shall be installed and used such that parts of the user's body other than the hands are maintained at a distance of approximately 20 cm (8 inches) or more. If you choose to use a clipping device, please make sure to only use the supplied VTech belt clip.

This Class B digital apparatus complies with Canadian ICES-003.

FCC Part 68 and ACTA

This equipment complies with Part 68 of the FCC rules and with technical requirements adopted by the Administrative Council for Terminal Attachments (ACTA). The label on the back or bottom of this equipment contains, among other things, a product identifier in the format US:AAAEQ##TXXXX. This identifier must be provided to your local telephone company upon request.

The plug and jack used to connect this equipment to premises wiring and the telephone network must comply with applicable Part 68 rules and technical requirements adopted by ACTA. A compliant telephone cord and modular plug is provided with this product. It is designed to be connected to a compatible modular jack that is also compliant. An RJ11 jack should normally be used for connecting to a single line and an RJ14 jack for two lines. See Installation Instructions in the user's manual.

The Ringer Equivalence Number (REN) is used to determine how many devices you may connect to your telephone line and still have them ring when you are called. The REN for this product is encoded as the 6th and 7th characters following the US: in the product identifier (e.g., if ## is 03, the REN is 0.3). In most, but not all areas, the sum of all RENs should be five (5.0) or less. For more information, please contact your local telephone company.

This equipment may not be used with Party Lines. If you have specially wired alarm dialing equipment connected to your telephone line, ensure the connection of this equipment does not disable your alarm equipment. If you have questions about what will disable alarm equipment, consult your telephone company or a qualified installer.

FCC, ACTA and IC regulations

If this equipment is malfunctioning, it must be unplugged from the modular jack until the problem has been corrected. Repairs to this telephone equipment can only be made by the manufacturer or its authorized agents. For repair procedures, follow the instructions outlined under the Limited Warranty.

If this equipment is causing harm to the telephone network, the telephone company may temporarily discontinue your telephone service. The telephone company is required to notify you before interrupting service. If advance notice is not practical, you will be notified as soon as possible. You will be given the opportunity to correct the problem and the telephone company is required to inform you of your right to file a complaint with the FCC. Your telephone company may make changes in its facilities, equipment, operation, or procedures that could affect the proper functioning of this product. The telephone company is required to notify you if such changes are planned.

If this product is equipped with a corded or cordless handset, it is hearing aid compatible.

If this product has memory dialing locations, you may choose to store emergency telephone numbers (e.g., police, fire, medical) in these locations. If you do store or test emergency numbers, please:

Remain on the line and briefly explain the reason for the call before hanging up.

Perform such activities in off-peak hours, such as early morning or late evening.

Industry Canada

Operation is subject to the following two conditions: (1) this device may not cause harmful interference, and (2) this device must accept any interference, including interference that may cause undesired operation.

The term "IC: " before the certification/registration number only signifies that the Industry Canada technical specifications were met.

The Ringer Equivalence Number (REN) for this terminal equipment is 0.1. The REN is an indication of the maximum number of devices allowed to be connected to a telephone interface. The termination on an interface may consist of any combination of devices subject only to the requirement that the sum of the RENs of all the devices does not exceed five.

This product meets the applicable Industry Canada technical specifications.

The RBRC® seal



The RBRC® seal on the nickel-cadmium battery indicates that VTech Communications, Inc. is voluntarily participating in an industry program to collect and recycle these batteries at the end of their useful lives, when taken out of service within the United States and Canada.

The RBRC® program provides a convenient alternative to placing used nickel-cadmium batteries into the trash or municipal waste, which may be illegal in your area.

VTech's participation in RBRC® makes it easy for you to drop off the spent battery at local retailers participating in the RBRC® program or at authorized VTech product service centers. Please call **1-800-8-BATTERY™** for information on Ni-Cd battery recycling and disposal bans/restrictions in your area. VTech's involvement in this program is part of its commitment to protecting our environment and conserving natural resources.

RBRC® is a registered trademark of Rechargeable Battery Recycling Corporation.

Technical specifications

Frequency control	Crystal controlled PLL synthesizer
Transmit frequency	Handset: 912.75-917.10 MHz Telephone base: 2410.20-2418.90MHz
Receive frequency	Handset: 2410.20-2418.90 MHz Telephone base: 912.75-917.10MHz
Channels	30
Nominal effective range	Maximum power allowed by FCC and IC. Actual operating range may vary according to environmental conditions at the time of use.
Size	Handset: 7.25in X 2.04in X 1.48in (184.1mm X 51.8mm X 37.5mm) Telephone base: 4.34in X 3.37in X 4.82in (110.2mm X 85.5mm X 122.4mm)
Weight	Handset: 5.36oz (151.9 grams) (including battery) Telephone base: 4.24oz (120.2 grams)
Power requirements	Handset: 3.6V 300mAh Ni-Cd battery Telephone base: 7.5V AC @ 200mA
Memory	Handset directory: 10 memory locations (9 speed dial inclusive); up to 24 digits and 14 characters Handset call log: 30 memory locations; up to 11 digits and 15 characters

Index

A

- About caller ID 25
- About cordless telephones 45
- Answer calls 12

B

- Battery 3, 33

C

- Call log 26
- Call log display screen messages 31
- Call waiting 13
- Channel 12
- Character chart 16
- Charging 3
- Clear voicemail 11
- Copy a directory entry into speed dial 20

D

- Date and time 7
- Delete a directory entry 19
- Delete a speed dial entry 23
- Delete from the call log 30

- Dial a call log number 28
- Dial a number from the directory 20
- Dial a speed dial number 23
- Dial mode 9
- Directory 15
- DSL filter 2

E

- Edit a directory entry 18
- Edit a speed dial entry 22
- End calls 12

F

- FCC, ACTA and IC regulations 47
- Find handset 14

H

- Handset display screen messages 32
- Home area code 9

I

- Index 50

Index

- L**
Language 10
- M**
Maintenance 44
Make a call log entry ready to dial 27
Make calls 12
Mounting bracket installation 4
- O**
Operating range 44
- P**
Parts checklist 1
Pause 15, 18
- R**
RBRC® seal 48
Reassign speed dial locations 24
Redial 14
Review the call log 27
Review the directory 17
Ringer 8
Ringer volume 8
- S**
Save a call log entry to the directory 29
Speed dial 21
Store a directory entry 15
Store a speed dial entry 21
- T**
Technical specifications 49
Temporary tone dialing 13
Troubleshooting 35
- V**
Volume 8, 12
- W**
Wall mounting 4
Warranty 45

VTECH TELECOMMUNICATIONS LTD.
A member of THE VTECH GROUP OF COMPANIES.
Distributed in the U.S.A. by VTech Communications, Inc. Beaverton, Oregon
Distributed in Canada by VTech Technologies Canada, Ltd., Richmond, B.C.
Copyright ©2007 for VTECH TELECOMMUNICATIONS LTD.
Printed in China.

91-001545-050-100