

**Uniden<sup>®</sup>**

**UIP1868P**

**OWNER'S**

**MANUAL**

**OWNER'S MANUAL**

# Contents

<b>WELCOME/FEATURES</b>	<b>2</b>	<b>CALLER ID</b>	<b>48</b>
<b>TERMINOLOGY</b>	<b>4</b>	Caller ID and CIDCW	48
<b>CONTROLS &amp; FUNCTIONS</b>	<b>5</b>	<b>MULTI-HANSET FEATURES</b>	<b>52</b>
<b>GETTING STARTED</b>	<b>7</b>	Multi-Handset Features	52
Setting up the Phone	7	Using DirectLink Mode	52
Expanding Your Phone	14	Using the Room/Baby Monitor	54
Registering Expansion Handsets	15	Using the Intercom	55
Installing the Beltclip	17	<b>TROUBLESHOOTING</b>	<b>58</b>
Headset Installation	17	Troubleshooting	58
Display and Icons	18	<b>ADDITIONAL INFORMATION</b>	<b>65</b>
Soft Key Function	19	Note on Power Sources	65
Main Menu Options	20	General Information	67
Setting Menu Options	21	Liquid Damage	68
<b>BASICS</b>	<b>30</b>	<b>PRECAUTIONS &amp; WARRANTY</b>	<b>69</b>
Using Your Phone	30	<b>I.C. NOTICE</b>	<b>70</b>
Call Waiting	32	<b>INDEX</b>	<b>71</b>
Placing a Call on Hold	32		
Redialing a Call	33		
Adjusting the Ringer, and Earpiece and Speaker Volume	34		
Muting the Ringer	35		
Muting the Microphone	36		
Traveling Out of Range	36		
Privacy Mode	37		
Conferencing	37		
Find Handset	38		
Using One Touch Voice Mail Access	39		
<b>PHONEBOOK</b>	<b>40</b>		
Setting up the Phonebook	40		
Viewing the Phonebook	44		
Making Calls Using the Phonebook	45		
Speed Dialing	45		
Editing or Erasing a Stored Name, Phone Number, Distinctive Ring and Speed Dial	46		
Copying Phonebook Entries	47		

# Welcome

With the UIP1868P voice-over-Internet Protocol (VoIP) telephone, Packet8 VoIP service and your broadband connection, you can access the Internet and make phone calls simultaneously. The UIP1868P connects directly to your broadband modem. It separates voice signals from data signals and sends voice traffic to its cordless handsets and data traffic to your computer.

If you have a local switch or router supporting a LAN, the UIP1868P will pass all Ethernet traffic through to your LAN.

**Note: Illustrations in this manual are used for explanation purposes.  
Some illustrations in this manual may differ from the actual unit.**

# Features

- 5.8GHz Digital Expandable
- Corded/Cordless Telephone System
- Dual Keypad and LCD Screen at Base
- Ten Multi-Handset Expandability
- Hands-Free Duplex Speakerphone in the Handset and Base
- Caller ID/Call Waiting Deluxe (Subscribe through Service provider)
- 100 Programmable Memory Locations in the Base and Each Cordless Handset
- Intercom/Call Transfer Between Handsets or Handset and Base
- 20 Distinctive Ring Options (Ten Ringer Tones and Ten Melody Ringers)
- Mute and Hold Features
- Do Not Disturb (DND) Feature
- DirectLink™ Mode
- Room/Baby Monitoring
- Battery Level Indicator
- Clock Display
- Animation Displays

This series features **AutoTalk™** and **AutoStandby™**. AutoTalk allows you to answer a call by just removing the handset from the cradle so you don't have to waste time pushing buttons. AutoStandby allows you to hang up by simply returning the handset to the cradle.

To protect you against mis-billed calls that might result from your phone being activated by other equipment, this series has **Random Code™** digital security, which automatically selects one of more than 10,000,000 digital security codes for the handset and base.

Digital Spread Spectrum Technology uses a wider frequency band than standard digital transmissions. The result is a more secure conversation with the clarity of digital sound, extended range, and minimal interference from other cordless phones.

**IntegriSound™** Built in sound quality which provides life-like conversations.

With **DirectLink™** mode, you can use two or more handsets as radio tranceivers (walkie-talkies).

Be sure to visit our web site: [www.uniden.com](http://www.uniden.com)

Uniden® is a registered trademark of Uniden America Corporation.

AutoTalk, AutoStandby, DirectLink, IntegriSound and Random Code are trademarks of Uniden America.

## **Accessibility**

If you have a disability and need customer service assistance or if you have any questions about how Uniden's products can accommodate persons with disabilities, please call the accessibility voice/TTY line:1-800-874-9314

A representative is available to talk to you M-F, 8:00 am to 5:00 pm, CST. After hours, you can leave us a message, and we will call you back. Information is also available on our website, [www.uniden.com](http://www.uniden.com), under the "Accessibility" link.

# Terminology

- **Standby Mode** - The handset maybe sitting or off the cradle, but is NOT in use. *talk/flash* or *speaker* has not been pressed. The corded base handset is on the base and *speaker* on the base has not been pressed. No dial tone is present.
- **Talk Mode** - The handset is off the cradle and *talk/flash* or *speaker* has been pressed, or pick up the corded base handset and *speaker* on the base is pressed and enabling a dial tone.
- **VoIP** - Voice over Internet Protocol, a method of sending voice signals over broadband Internet connections.
- **Station** - The main base or any registered handset.



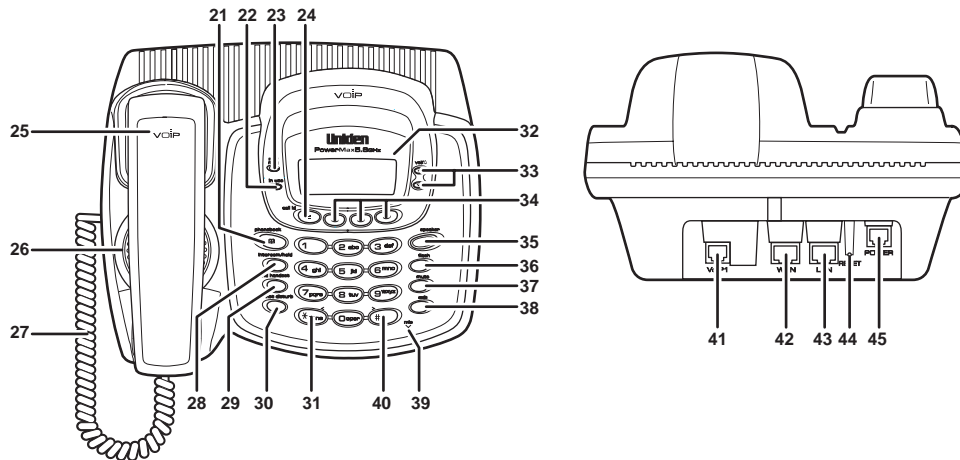

- 21. **phonebook** (P. 40)
- 22. In use LED
- 23. New Message LED
- 24. **call id** (P. 49)
- 25. Corded Base Handset
- 26. Base Speaker
- 27. Curl Cord
- 28. **intercom/hold** (P. 55 & 32)
- 29. **find handset** (P. 38)

- 30. **do not disturb** /DND LED (P. 35)
- 31. **\*/tone/ <** (P. 51 & 41)
- 32. LCD Display
- 33. **▲/vol ▼/▼** (volume up/down) (P. 34 & 21)
- 34. **soft** Keys (P. 19)
- 35. **speaker**/speaker LED (P. 31)
- 36. **flash** (P. 32)
- 37. **mute** (P. 36)

- 38. **exit** (P. 21)
- 39. mic (microphone)
- 40. **#/ >** (P. 51 & 41)
- 41. VoIP1 port
- 42. WAN port
- 43. LAN port
- 44. Reset Switch
- 45. Power port

# Setting up the Phone

## Safety Recommendations

To ensure general safety, follow these guidelines:

- Do not open or disassemble this product.
- Do not expose the product to moisture.
- Do not perform any action that creates a potential hazard to people or makes the equipment unsafe.
- Ultimate disposal of this product should be handled according to all national laws and regulations.
- Do not touch the wires on the cable ports or the wires of cables connected to a port as hazardous voltage may be present on these wires when the equipment is powered on.
- The plug-socket combination must be accessible at all times because it serves as the power disconnect.
- To avoid electric shock, do not connect the UIP1868P to any RJ-11 telephone wall jacks. Use caution when connecting cables. This could damage the UIP1868P or the telephone wiring in the building.
- Do not work on the system or connect or disconnect cables if lightning or thunder are present in your area.
- Do not cover or block the air vents on the top or bottom surface of the UIP1868P. Overheating can cause permanent damage to the unit.
- Read the instructions completely before connecting the system to its power source.



## 911 Service Notice

Packet8 services do not include traditional 911 emergency dialing. Packet8 offers Enhanced 911 service (an FCC standard developed for emergency calling from wireless phones) at an additional monthly fee. A subscription to Packet8's Enhanced 911 service is required for emergency calling. Packet8's Enhanced 911 optional service is not available in all areas.

## Before You Start!

Visit the Packet8 activation website <http://activate.packet8.net/> and enter the MAC address ID found on the bottom of your UIP1868P. After you activate the UIP1868P, you will receive an email containing a 10-digit activation code. You will need this activation code in Step 3.

## STEP 1: Check Your Equipment

Check your broadband setup and the other equipment you will need:

- A broadband modem and a broadband Internet connection
- A computer with an Ethernet port (or a local Ethernet switch or router)
- One CAT-5 Ethernet cable
- The Packet8 10-digit activation code that was emailed to you when you created your account. (If you don't have this email, go to [www.packet8.net](http://www.packet8.net) and enter the email address and password used to create the account in the account sign in at the top of the screen.)
- If you want to use a backup phone along with the UIP1868P, you will need a standard telephone cable (RJ-11).



If you ordered your UIP1868P directly from Packet8, it will already be activated for you. Your 10-digit activation code was in the confirmation email you received when your UIP1868P shipped. (If you don't have this email, go to [www.packet8.net](http://www.packet8.net) and enter the email address and password used to create the account in the account sign in page.)

## Check Your Broadband Configuration

The UIP1868P supports the two most common broadband connection protocols: DHCP and PPPoE. If your broadband connection uses DHCP, you do not need to change any settings on the UIP1868P. If your broadband connection uses PPPoE, you will need to enter your user name and password in the UIP1868P. If your broadband provider has given you a static IP address, you will need to enter that information in the UIP1868P. For more information on configuring your UIP1868P visit <http://www.uniden.com/voip>.

## STEP 2: Connect Your UIP1868P

Once your account is set up, you can connect your UIP1868P.

- 1) Use the coil cord to connect the corded handset to the base.
- 2) Use the included Ethernet cable to connect your broadband modem to the RJ-45 port labeled **WAN**.

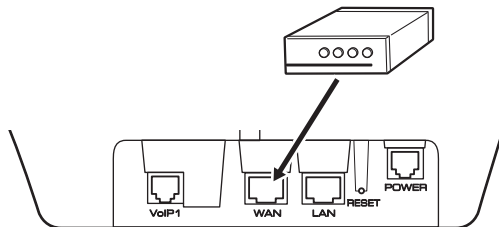

3) Use another Ethernet cable to connect your PC to the RJ-45 port labeled **LAN**. If you use a switch or router for a local network, connect it to the LAN port instead.

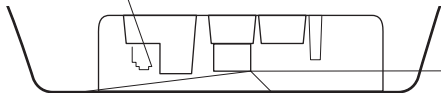

4) **OPTIONAL:** If you have a second phone you want to use for line 1, connect it to **VoIP1**.

**CAUTION**

*Do not connect the UIP1868P to a regular telephone wall jack.*

- 5) Use the included AC abapter to connect the **POWER** port to a 120 Vac continuous power outlet.

### **CAUTION**

*To avoid risk of fire or electrical hazard, use **ONLY** the included AC adapter!*

All the LEDs will flash several times, and the PWR LED will remain on. If the UIP1868P was properly recognized by Packet8's network, the CA LED will remain on. Test your connection by making a call with the corded handset and browsing to a web page from your PC. If you have any difficulty, see the Troubleshooting section.

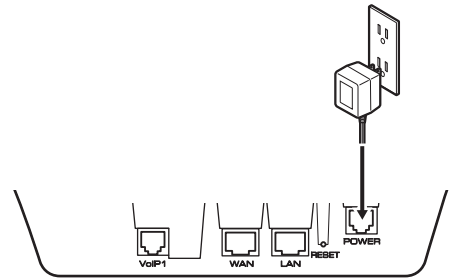

### **Step 3 Activate your Packet8 Service**

Once you have connected your UIP1868P, you can activate your Packet8 service

- You will need your 10-digit activation code that was sent to you by email when your Packet8 order shipped. (You can also obtain your activation code at [www.packet8.net](http://www.packet8.net) by signing in at your account page.)
- Pick up your telephone handset and dial the Activation Service number 012-0001.
- Follow the voice instructions and enter your 10-digit activation code.
- When you enter a valid code, your account will be activated and your Packet8 phone number will be emailed to you. This Packet8 phone number can also be found in your account details page after signing in at [www.packet8.net](http://www.packet8.net).

## Install

- 1) Press down on the  
finger indentation for  
downward to remove
- 2) Plug the battery pack  
the jack inside the batt  
notches fit into the groc  
Match the wire colors to  
compartment, connect the  
insure connection.
- 3) Make sure you have a good c  
on the battery wires. If the c  
battery jack will remain in pla
- 4) Place the battery case cover ba  
it upwards until it clicks

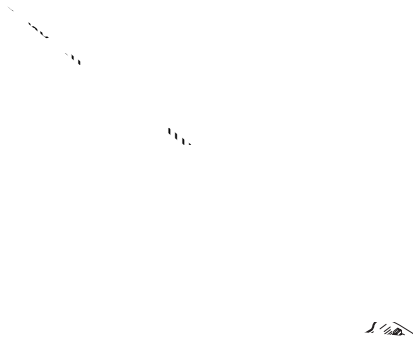

## Connect the charger

The handset is powered by a rechargeable battery pack. The battery recharges automatically when the handset is placed in the charger.

- 1) Connect the AC adapter to the DC IN 9V jack and to a standard 120V AC wall outlet.

**Caution:** To avoid risk of fire or shock, use only the included AC adapter.

- 2) Set the charger on a desk or tabletop, and place the handset in the charger with the keypad facing forward.
- 3) Make sure that the **charge** LED illuminates.  
If the LED does not illuminate, check to see that the AC adapter is plugged in and the handset makes good contact with the base charging contacts.
- 4) Charge the handset battery pack for at least 15-20 hours before using your new cordless handset for the first time.

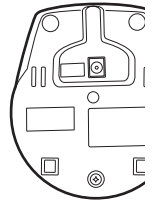

# Your Phone

## Ability

sets, including  
e. You can  
+

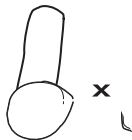

be used  
lls. It  
outside  
when

without

na  
lln  
λ



If a handset has ever been registered to a different base, you must de-register the handset before you can register it to the new base (see page 16.)

## Registering Expansion Handsets

Handsets supplied with the phone are registered to the base by the factory. When charged, pre-registered handsets display a handset ID number. Handsets that have not been registered display `Place handset on main base to register`. When you register an extra handset to the base, the handset ID will be assigned.

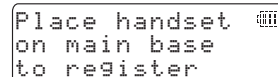

Place handset  
on main base  
to register

Before the expansion handset is registered, the battery pack **MUST** be charged for 15-20 hours.

### To register expansion handsets, follow the steps below:

- 1) Make sure the main base is in standby mode.
- 2) On the base, press the **MENU** soft key, and then select HS Registration.
- 3) On the handset, press and hold **#** for two seconds. To cancel registration, press the **CANCEL** soft key on the base.
- 4) While the handset is registering, `Handset Registering` will appear in the Handset LCD. When `Registration Complete` is displayed, the handset has been registered to the base. If `Registration Failed` appears, please try these steps again.



## De-register the Handset

You can deregister the handset's ID from the main base unit or the base ID from the handset. You will usually only deregister the handset if you want to change the base you use it with, if you are having a problem with your phone, or if you need to change the digital security code. The digital security code is an identification code used to connect the handset and the base unit. Normally, setting the code is not necessary. In the rare situation that you suspect another cordless telephone is using the same security code, you can change the code by de-registering and re-registering all handsets.

- 1) On the handset, press the **MENU** soft key. Select Deregister HS in the menu and press the **OK** soft key.

Deregister HS? appears.

- 2) Press **▲ volume up/down** to select Yes and then the **OK** soft key.

When de-registration is complete you will hear a confirmation tone, and

Deregistration Complete appears.

- 3) After de-registering the handset, you must re-register the handset before you can use it.



## Installing the Beltclip

### **To attach the beltclip**

Insert the beltclip into the holes on each side of the handset.  
Press down until it clicks.

### **To remove the beltclip**

Pull either side of the beltclip to release the tabs from the holes.

## Headset Installation

Your cordless handset may be used with an optional headset. To use this feature, insert the headset plug into the headset jack. Your phone is ready for hands-free conversations. (Headsets may be purchased by calling the Uniden Parts Department or visiting the web site. See back cover page.)

# Display and Icons

Example of the standby mode display

- **Handset**



— Ringer off icon (when the ringer is off)/ day of the week and time / battery icon  
 — Handset ID and Banner  
 — Number of new Caller ID calls received (If there are no new Caller ID messages, the Handset ID appears here.)

- **Base**



\* This icon changes depending on ringer volume level (High, low and off)

ICON	Appears During	DESCRIPTION
	Standby/Talk	<b>Battery</b> icons indicate the handset battery status. This icon changes depending on the battery status (empty, low, medium and full).
	Standby	The <b>Ringer off</b> icon indicates that ringer is turned off.
	Talk	The <b>Mute</b> icon appears when you mute the handset or base.
	Talk	The <b>Speaker</b> icon appears when the handset speaker phone is used (handset only).
	Talk	The <b>Privacy</b> icon appears when the Privacy Mode is turned on.
	Standby	When a new message is received, an <b>envelope</b> icon is displayed on the LCD screen (base only).

# Soft Key Function

"Soft" keys are keys that change function during the operation of the phone. There are three soft keys on the base and three soft keys on each handset. Soft keys allow you to:

- Access the main menu
- Redial one of the last three numbers dialed

Note: The soft keys will not appear while the handset is charging.

The function of each soft key is determined by the icon that appears directly above it. For example, when the handset is in standby mode, pressing soft key 1 will redial the last number. When the handset is in talk mode, pressing soft key 1 will mute the microphone.

Complete information on the features controlled by the soft keys can be found under each feature.

## In standby mode Handset

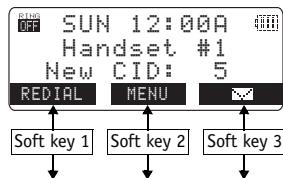

## In talk mode Handset



## Base

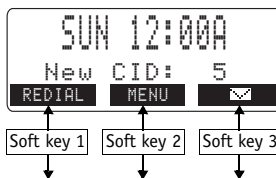

## Base (base speaker phone)

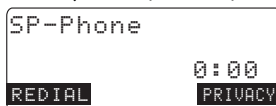

## (Corded base handset)



# Main Menu Options

Your phone has eight main menu options: **DirectLink Mode**, **Room/Baby Monitor**, **Handset Setup**, **Base Setup**, **Global Setup**, **Deregister HS** and **HS Registration**. You can change **Room/Baby Monitor**, and **Global Setup** settings from the base or from any handset. **DirectLink Mode**, **Handset Setup**, and **Deregister HS** are only available from a handset. **Base Setup** and **HS Registration** are only available from the base.

## Default Settings

The default settings set from the factory match the features that most people use. You may not need to change them. However, there are a number of options you must set and entries you must make in memory to take full advantage of all the phone features. The table below lists the default settings.

Function	Handset	Base	Function	Handset	Base
Edit Voice Mail	None		Contrast	level 5	
Ringer Tones	Flicker	-	Key Touch Tone	On	-
Distinctive Ring	On	-	Animation Screen	On	-
Auto Talk	Off	-	Day & Time	SUN 12:00 AM	
Anykey Answer	Off	-	CIDCW	CW on/CWDX off	
Banner	" "	-	Area Code	None	
Language (LCD)	English		Voice Mail Tone/Dial Mode	Set for use with Packet8 services. Do not change these settings.	

# Setting Menu Options

## Using the interface

Below are some tips for using the software interface on your phone.

- Press the **MENU** soft key to access the main menu.
- Use **volume up/down** to scroll through options.
- Press the **OK** soft key to make a selection.
- Press the **BACK** soft key to return to the previous screen.
- Press **end** on the handset or **exit** on the base to exit the menu.
- If you do not press a key within 30 seconds, the phone will time out and exit the menu mode. When setting Day and Time, the time-out period is extended to two minutes.

## Handset Setup / Base Setup

The following submenu options must be set separately for each handset and the base.

### Selecting a Ringer Tone (Handset only)

Ringer tone lets you choose from ten ringer tones or ten melodies:

- Ringers (Flicker, Clatter, Soft Alert, Wake Up, Light Bug, Beep Boop, Tone Board, Chip Chop, Party Clap, Reminder)
  - Melodies (Beethoven's Symphony #9 [Beethoven9], For Elise [Elise], We Wish You A Merry Christmas [Merry- Xmas], Home Sweet Home [Hm Swt Hm], Lorri Song #6 [Lorri Song], When the Irish Eyes Are Smiling [Irish Eyes], Aura Lee, Let Me Call You Sweet Heart [Sweetheart], Star Spangled Banner [Star Spngl], Old MacDonald [Old MacDld])
- You must set a separate ringer tone on each handset.

- 1) Press the **MENU** soft key. Select the Handset Setup menu, and then the Ringer Tones submenu.
- 2) Press  $\Delta$  **volume up/down** to move the pointer. You will hear the ringer or melody as you scroll through the options.
- 3) Press the **OK** soft key. You will hear a confirmation tone.

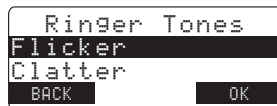

If you set the ringer to off, no ringer or melody will sound.

## Distinctive Ringer Setup (Handset only)

Distinctive Ringer allows you to assign a designated ring tone to a stored phonebook number. When a call is received and the Caller ID information matches the information in one of the phonebook memory locations, the phone uses the distinctive ring assigned to that particular caller. You can assign distinctive rings to multiple phonebook memory locations. Switching the setting to Distinctive Off disables distinctive ringing: all incoming calls will have a normal ring tone. Switching to Distinctive On activates all programmed distinctive ring memory locations.

- 1) Press the **MENU** soft key. Select the Handset Setup menu, and then the Distinctive Ring submenu.
- 2) Press  $\Delta$  **volume up/down** to select On or Off.
- 3) Press the **OK** soft key. You will hear a confirmation tone.

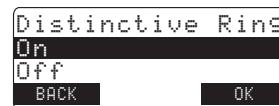

## Setting AutoTalk (Handset Only)

Autotalk allows you to answer the phone simply by removing the handset from the cradle. You do not have to press any buttons to answer the call.

- 1) Press the **MENU** soft key. Select the Handset Setup menu, and then the AutoTalk submenu.
- 2) Press  $\Delta$  **volume up/down** to select On or Off.
- 3) Press the **OK** soft key. You will hear a confirmation tone.





## Setting Anykey Answer (Handset only)

Anykey Answer allows you to answer the phone by pressing any number key, *\*/tone/<*, or *#/>* on the handset.

- 1) Press the **MENU** soft key. Select the Handset Setup menu, and then the Anykey Answer submenu.
- 2) Press  $\triangle$  **volume up/down** to select On or Off.
- 3) Press the **OK** soft key. You will hear a confirmation tone.



## Setting the True Banner (Handset only)

True Banner lets you customize the name your handset displays. The name will be displayed on the LCD screen during Standby Mode, Intercom, Intercom Hold, Room Monitor and Copy Phonebook operation. The banner name will be displayed on the receiving handset as well.

- 1) Press the **MENU** soft key. Select the Handset Setup menu, and then the Banner submenu.
- 2) Use the number keypad (**0-9**), *\*/tone/<*, *#/>*, or the **DELETE** soft key to enter or edit the name.
- 3) Press the **OK** soft key. You will hear a confirmation tone.



## Selecting a Language

You can change the language the menu display will use. Choose from English, French, or Spanish.

- 1) Press the **MENU** soft key. Select the Handset Setup menu or the Base Setup menu, and then the Language submenu.
- 2) Press  $\Delta$  **volume up/down** to choose "English," "Français" (French), or "Español" (Spanish).
- 3) Press the **OK** soft key. You will hear a confirmation tone.

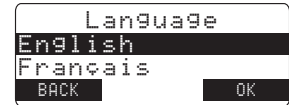

## Adjusting the LCD Contrast

Contrast adjusts the handset LCD brightness. Choose one of the ten levels for optimum viewing.

- 1) Press the **MENU** soft key. Select the Handset Setup menu or the Base Setup menu, and then the Contrast submenu.
- 2) Press  $\Delta$  **volume up/down** to adjust the contrast of the LCD (ten levels.)
- 3) Press the **OK** soft key. You will hear a confirmation tone.



## Setting the Key Touch Tone (Handset only)

Key Touch Tone is the tone your keypad makes when keys are pressed. You can turn this tone on or off.

- 1) Press the **MENU** soft key. Select the Handset Setup menu, and then the Key Touch Tone submenu.
- 2) Press  $\Delta$  **volume up/down** to select On or Off.
- 3) Press the **OK** soft key. You will hear a confirmation tone.



## Setting the Animation Screen (Handset Only)

The Animation Screen displays animation on the handset LCD. The animations will be displayed on the LCD screen during a call, ringer volume setting, paging operation, when you hang up and so on.

- 1) Press the **MENU** soft key. Select the Handset Setup menu, and then the Animation Screen submenu.
- 2) Press  $\Delta$  **volume up/down** to select On or Off.
- 3) Press the **OK** soft key. You will hear a confirmation tone.



The handsets have a variety of animation displays. Below are examples of the animation screens and what they mean:

Turning on the phone

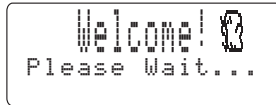

Hanging up the phone



Confirmation (Done!)



Making a Call



Find / Paging Handset



Deleting(Deleted!)



Also, the animation display changes depending on the ringer volume setting.



Out of Range



Unavailable



Low Battery



## Global Setup

If you change one of the global settings, you change that setting for all registered handsets and the base. Only one handset or the base can change global settings at a time.

### Setting Day and Time

Day & Time sets the day and time of your display.

- 1) With the phone in Standby mode, press the **MENU** soft key. Select the Global Setup menu, and then select Day & Time.
- 2) Press  $\Delta$  **volume up/down** to select the day of the week, and then the  $\rightarrow$  soft key.
- 3) Press  $\Delta$  **volume up/down** to set hour, and then press the  $\rightarrow$  soft key.
- 4) Press  $\Delta$  **volume up/down** to set minute, and then press the  $\rightarrow$  soft key.
- 5) Press  $\Delta$  **volume up/down** to choose AM or PM, and then press the **SAVE** soft key. You will hear a confirmation tone.

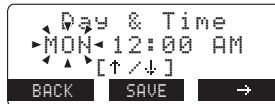

note

- The Dial Mode setting is pre-configured to support VoIP. Do not change this setting.

- If no key is pressed for two minutes, the phone will exit menu mode.



•Call Waiting Deluxe (CWDX) may not be supported by your phone service provider.

•If the area code has already been stored in memory, the stored area code will be displayed. To change it, use the **DELETE** soft key and number keys to enter the new area code.

## Setting CIDCW (Caller ID on Call Waiting)

CIDCW sets the Caller ID on Call Waiting (CIDCW) displays the name and number of an incoming call while you are on the line.

1) With the phone in Standby mode, press the **MENU** soft key. Select the Global Setup menu, and then the CIDCW submenu.

2) Press  $\Delta$  **volume up/down** to select CW On/CWDX On, CW On/CWDX Off, or CW Off/CWDX Off, and then press the **OK** soft key. You will hear a confirmation tone.



## Setting the Area Code

If you enter a 3-digit area code number in the "Area Code" option, your local area code does not appear in the Caller ID message. For calls received from outside your local area code, you will see a full 10-digit number.

1) With the phone in Standby mode, press the **MENU** soft key. Select the Global Setup menu, and then the Area Code submenu.

2) Press the number keypad (**0-9**) to enter a 3-digit area code.

3) Press the **OK** soft key. You will hear a confirmation tone.

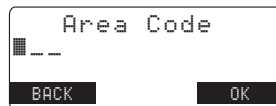

# Using Your Phone

## Calling with Packet8 service

- To call anywhere in the world, dial: country code + area code + number. For example, the country code for the U.S. and Canada is "1." To call anywhere within the US or Canada, dial: 1 + area code + number
- Anyone can call you at your Packet8 phone number.

## Making and Receiving Calls

### Making a call

#### From the handset

- 1) Remove the handset from the cradle.
- 2) Press **talk/flash**.
- 3) Listen for the dial tone.
- 4) Dial the number.

OR

- 1) Remove the handset from the cradle.
- 2) Dial the number.

If pause is required, press the **PAUSE** soft key. P appears in the display, which represents a pause

- 3) Press **talk/flash**.

#### From the Handset Speakerphone

- 1) Remove the handset from the cradle.
- 2) Press **speaker**.
- 3) Listen for the dial tone.
- 4) Dial the number.
- 5) When the other party answers, talk into the microphone.



- If the line is in use by another station, "Line In Use" appears in the display of all other stations.
- The handset microphone is located at the bottom of the handset. Position yourself as near to the handset as possible and speak clearly.



- To set "Autotalk", see page 23 or to set "Anykey Answer" see page 24.
- The base microphone is located under the base. Position yourself as near to the base as possible.

### From the base

- 1) Pick up the corded handset, or press *speaker*.
- 2) Listen for the dial tone.
- 3) Dial the number.

OR

- 1) Dial the number.  
If pause is required, press the **PAUSE** soft key.
- 2) Pick up the corded handset, or press *speaker*.

### Receiving a call

#### From the handset

- 1) Remove the handset from the cradle. (If AutoTalk is on, the phone will automatically answer the call when you pick it up.)
- 2) Press *talk/flash*.

OR

If the handset is off the cradle, press *talk/flash*. (If AnyKey answer is turned on, you can also press any key.)

#### From the base

Press *speaker* or pick up the corded handset.



## Hanging Up

From the handset or handset speakerphone, press **end**. (If AutoStandby is turned on, you can just return the handset to the cradle.)

From the base, press **speaker** or return the corded handset to the base.

## Switching to the Speakerphone During a Call

On the handset or base to switch a normal call to the speakerphone, press **speaker**.

To switch from a speakerphone call to a normal call, press **speaker** again.

## Call Waiting

If a call waiting tone sounds while you are on a call, press **talk/flash** on the handset or **flash** on the base to accept the waiting call. There is a short pause, and then you will hear the new caller. To return to the original caller, press **talk/flash** on the handset or **flash** on the base again.

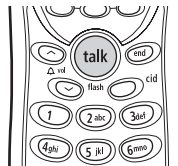

## Placing a Call on Hold

- 1) During a call, press **intcom/hold** on the handset or **intercom/hold** on the base. The call will be put on hold.



If you leave a call on hold for more than ten seconds, the display screen will read, `Line On Hold`.

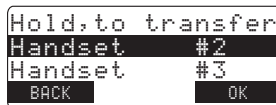



- You can place a call on hold for five minutes. When five minutes has passed, the call is disconnected, and the phone returns to standby mode.
- While a call is on hold, CIDCW can not be received.
- If the number exceeds 32 digits, only the first 32 digits are retained in redial memory.
- If the redial memory is empty, you will hear a beep.
- Redial numbers stored in the handset and the base are independent from each other.

- 2) To return to the call, pick up the corded handset or press **talk/flash** on a handset. To talk to the caller on a speakerphone, press **speaker** on the base or on a handset.

## Redialing a Call

The last three phone numbers dialed can be quickly redialed from the handset or base.

- 1) With the phone in standby mode, press the **REDIAL** soft key.
- 2) Press  $\Delta$  **volume up/down**. Each press of  $\Delta$  **volume up/down** will display one of the last three number redialed.
- 3) Press **talk/flash** or **speaker** on the handset (or pick up the corded base handset, or press **speaker** on the base). The selected number is dialed.
- 4) To hang up, press **end** (or return the corded base handset to the base, or press **speaker** on the base).

For the base, you can also redial the last number dialed with the phone in talk mode. Press the **REDIAL** soft key.

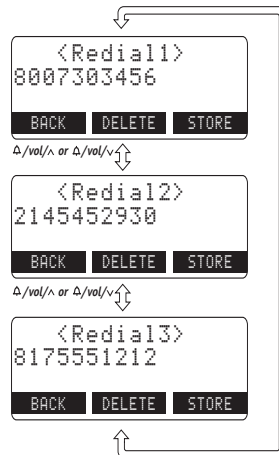

# Adjusting the Ringer, and Earpiece and Speaker Volume

## Ringer volume

With the phone in standby mode, press the volume up key or volume down key on the handset or base to select one of three ringer volumes (Off, Low, or High).

## Earpiece Volume

Both the handset and the base offer six volume levels. To adjust the volume, press the volume up (to increase the volume) or volume down (to decrease the volume) while you are on a normal call. The new volume setting remains in effect after the telephone call has ended.

## Speaker Volume

The handset speakerphone provides six volume levels; the base speakerphone provides ten volume levels. To adjust the volume, press the volume up (to increase the volume) or volume down (to decrease the volume) while you are on a speakerphone call. The new volume setting remains in effect after the telephone call has ended.

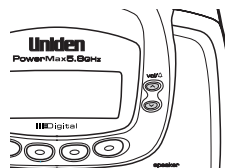
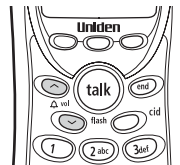

note

If you press the volume up key when the earpiece is at the maximum volume level, an error tone sounds. The error tone also sounds if you press the volume down key at the lowest volume.



You cannot mute a handset's ringer while the handset is on the cradle.

## Muting the Ringer

### **Do Not Disturb (DND)**

The do not disturb feature (DND) allows you to mute the ringer, the base, and any registered handsets at the same time. With the phone in standby mode, press and hold ***do not disturb*** on the base. You will hear a confirmation tone, and the **DND** LED illuminates. To cancel the DND feature, press ***do not disturb*** again. You can also mute the ringer tone while the phone is ringing by pressing ***do not disturb*** on the base.

### **Temporarily Muting the Ringer**

To mute the ringer tone temporarily on a single station, press the **MUTE** soft key on that station while the phone is ringing. The mute will last for the current incoming call only. The ringer tone will return to the previous setting on the next incoming call.

# Muting the Microphone

You can temporarily mute the microphone so that the caller cannot hear you.

## On the handset

During a call, press the **MUTE** soft key to mute the microphone.

Mute On and  appear in the display. To cancel muting, press the **MUTE** soft key again. Mute Off appears.

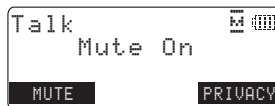

## On the base

During a call, press **mute** to mute the base microphone.

Mute On and  appear in the display. To cancel muting, press **mute** again or press **speaker**. Mute Off appears.

# Traveling Out of Range

During a call, as you begin to move your handset too far from your base, noise may increase. If you pass the range limits of the base, you will hear a beep and see Out of Range on the display, and then the handset returns to standby mode.

## Privacy Mode

Privacy Mode prevents interruption from other stations during a call.  
From the handset

While you're on a call, press the **PRIVACY** soft key. *Privacy Mode On* and  appear in the display. The phone will exit Privacy Mode automatically when you hang up. To exit Privacy Mode and stay on the call, press the **PRIVACY** soft key again when the *Privacy Mode is on*. *Privacy Mode Off* appears.

## Conferencing

If you have more than one handset, up to four people can participate in a conference call.

### 3-Way Conferencing

- Outside line + Handset + Base (or Handset)

### 4-Way Conferencing

- Outside line + Handset + Handset + Base

### Joining a Conference Call

You can easily join a call already in progress.

### From the base

- 1) Press **speaker** or pick up the corded handset to join the conference call.
- 2) To hang up, press **speaker** or return the corded handset to the base. The handset(s) will still be connected to the call.

### From a second handset

- 1) Press **talk/flash** or **speaker** to join the call.
- 2) To hang up, press **end** or return the handset to the cradle. The other station will still be connected to the call.

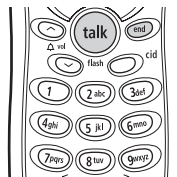

## Find Handset

To locate a handset, press **find handset** on the base when the phone is in standby mode. All registered handsets beep for 60 seconds, and **Paging** appears on the handset display. To cancel paging, press any key on the handset or **find handset** on the base.

If the battery pack is completely drained, the handset will not beep when paged.

## Using One Touch Voice Mail Access

The Voice Mail tone is pre-programmed to support Packet8's voice mail service. Do not alter this setting.

The UIP1868P provides one-touch access to Packet8's voice mail service. Follow the steps below to program the Packet8 access number into the base and any handset(s):

- 1) Press the **MENU** soft key, then choose Base Setup on the base or Handset Setup on any handset.
- 2) Scroll down and select Edit Voice Mail. `Edit V_ mail No.` appears in the display.
- 3) Enter the Packet8 VoiceMail access number: 012-0555.
- 4) Press the **OK** soft key.

When you have new messages, the New Message LED will flash. To retrieve your messages, simply press the  soft key. If you have not entered the access number or it has been deleted, when you press the  soft key, `No Number Stored To store number press [MENU]` appears and you will hear a beep. The phone returns to standby mode.

### Resetting the New Message LED

If the LED remains on after you've retrieved your messages, you may need to reset the indicators. With the phone in standby mode, press and hold ***find handset*** on the base until the paging sound stops (about 5 seconds).

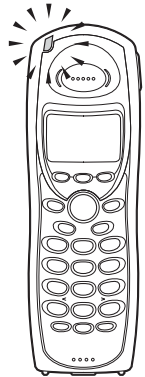



# Setting up the Phonebook

You can store names and numbers in your phone's phonebook, search for names alphabetically, and dial phonebook entries with just a few key presses. Phonebook memory is stored independently in the base and handsets. You can store up to 100 numbers in the base and up to 100 numbers in each handset.

The phone uses the same memory to store phonebook entries and Caller ID messages. If the shared memory is already full, the phone will not store a phonebook entry. You will have to delete some of the Caller ID messages before you can store a new phonebook entry.

The memory locations in the handset are not limited to phone numbers. You can also store a group of numbers (up to 20 digits) that you need to enter once your call connects.

## Storing and Editing Phone Numbers, Names, Distinctive Rings and Speed Dial

- 1) When the phone is in standby mode, press **phonebook**. The following items appear:  
(1st line) The number of the phonebook locations used  
(2nd line) How to search (press the number keypad,  $\Delta$  **volume up/down**)  
(3rd line) How to store (press the **STORE** soft key)  
(4th line) The **BACK** and **COPY**, and **STORE** soft keys.
- 2) Press the **STORE** soft key. **Store/Edit Name** appears.
- 3) Enter the name (up to 16 characters) by using the number keypad. If a name is not required, go to step 4. <No Name> will be used as the name.



```
Phonebook : 1
Search [A-Z/↑/↓]
Store [STORE]
BACK COPY STORE
```



```
Store/Edit Name
Uniden Corp█
BACK DELETE OK
```

note

When the memory is full, you will hear a beep and **Memory Full** appears. You will have to delete some Caller ID messages before you can store new phonebook entries.

number corresponding to the key.

For example, to enter Movies:

- 1) Press 6 once, and then press #/> to move the cursor to the right.
- 2) Press 6 six times.
- 3) Press 8 six times.
- 4) Press 4 six times.
- 5) Press 3 five times.
- 6) Press 7 eight times.

### If you make a mistake while entering a name

Use \*/tone/< or #/> to move the cursor to the incorrect character.

Press the **DELETE** soft key to erase the wrong character, and then enter the correct character. To delete all characters press and hold the **DELETE** soft key.

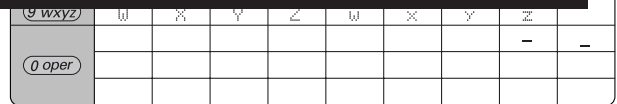

- 4) Press the **OK** soft key to store the name;  
Store/Edit No. appears.



- 5) Use the number keypad, *\*/tone/<*, or *#/>* to enter the phone number (up to 20 digits).  
If you make an error, use the **DELETE** soft key to erase the incorrect digits. When you are finished, press the **OK** soft key to store the number.

- 6) If you store the phonebook location in the handset, Distinctive Ring appears. Use  $\Delta$  **volume up/down** to select a Distinctive Ring tone and then press the **OK** soft key.  
If you don't want a distinctive ring for this entry, choose "No Selectn".

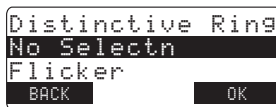

- 7) Speed Dial appears. Use  $\Delta$  **volume up/down** to select a Speed dial number (10 number: SPD1-SPD0).  
If you don't want a speed dial number for this entry, choose "No Selectn".

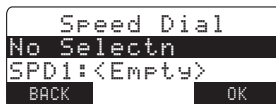

- 8) Press the **OK** soft key. You will hear a confirmation tone, and Done! appears in the display.



To insert a two-second pause in the dialing sequence, press the **PAUSE** soft key. If you need the phone to pause for more than two seconds before sending the next digits, press the **PAUSE** key more than once. Each pause counts as one digit.



If the Caller ID message was received as a private/unknown number, or the message does not have the number, you cannot store the message in the Phonebook. If it was received as private/unknown name, the message will be stored as <No Name>.

## Storing Caller ID messages in the Phonebook

Phone numbers and names in the Caller ID list can be stored in the phonebook easily.

- 1) When the phone is in standby mode, select the Caller ID message to be stored (see “Viewing the Caller ID List” on page 49). Then press the **STORE** soft key. *Store/ Edit Name* appears. If the Caller ID message is already stored in memory, you will hear a beep and *This data is already stored !!* appears. The number will not be stored.
- 2) To complete the setting, follow the steps 3-8 in “Storing and Editing Phone Numbers, Names, Distinctive Rings and Speed Dial” on page 40.

## Storing a Redial Record (Handset only)

- 1) With the phone in standby mode, press the **REDIAL** soft key.
- 2) Use  $\Delta$  **volume up/down** to select the number to be stored.
- 3) Press **STORE**. *Store/Edit Name* appears.
- 4) To complete the setting, follow the steps 3-8 in “Storing and Editing Phone Numbers, Names, Distinctive Rings and Speed Dial” on page 40.

## Viewing the Phonebook

- 1) Press **phonebook**. If you open the phonebook during a call, the **COPY** and **STORE** soft key will not appear.
- 2) Press  $\Delta$  **volume up/down** to scroll through the phonebook entries. Phonebook entries appear in alphabetical order (from first to last when you press  $\Delta$  **volume down**, from last to first when you press  $\Delta$  **volume up**).



You can also use the letters on the number keys to select the first letter of the desired name. Press a number key (**2-9** and **0**) once for the first letter, twice for the second letter, and so on. The first location that begins with the letter you entered appears.

For example, to search for an entry starting with "M," press **6** once. Press  $\Delta$  **volume up/down** until the phonebook entry is displayed.

- 3) To finish the viewing operation:

From the Handset-press **end** (or the **BACK** soft key during a call).

From the Base-press **exit** or the **BACK** soft key.

# Making Calls Using the Phonebook

## From Standby Mode

- 1) When the phone is in standby mode, select the phonebook location to dial (see "Viewing the Phonebook" on page 44).
- 2) Press **talk/flash** or **speaker** on the handset (or press **speaker** on the base or pick up the corded handset).
- 3) To hang up press **end** on the handset (or press **speaker** on the base or return the corded handset to the base).



## From Talk Mode

- 1) Press **talk/flash** or **speaker** on the handset (or press **speaker** or pick up the corded handset from the base).
- 2) Select the phonebook location to dial (see "Viewing the Phonebook" on page 44).
- 3) Press the **DIAL** soft key.
- 4) To hang up press **end** on the handset (or press **speaker** on the base or return the corded handset to the base).

# Speed Dialing

You can program up to ten speed dial numbers in the base and up to ten speed dial numbers in each handset. You can assign any entry in your phonebook to a speed dial number (see page 42). To use a speed dial number, when the phone is in standby mode, press and hold the number key (**0-9**) you assigned to the phonebook entry. When the phone number appears, press **talk/flash** or **speaker** on the handset or **speaker** on the base. The number stored in the speed dial is dialed.

# Editing or Erasing a Stored Name, Phone Number, Distinctive Ring and Speed Dial

- 1) When the phone is in standby mode, press **phonebook**.
- 2) Use  $\Delta$  **volume up/down** or the number keypad to select the desired phonebook entry (see "Viewing the Phonebook" on page 44).
- 3) To edit entry, press the **EDIT** soft key. To delete the entry, press the **DELETE** soft key.
- 4) If you are deleting the entry, press  $\Delta$  **volume up/down** to select **Yes**, and then press the **OK** soft key. you will hear a confirmation tone, and **Deleted!** appears in the display.



If you are editing the entry, follow the steps 3 to 8 under "Storing and Editing Phone Numbers, Names, Distinctive Rings and Speed Dial" on page 40 to complete the editing operation.



If the selected handset is out of range or data transfer is canceled, `Unavailable` appears in the display. Phonebook locations will not be transferred.

## Copying Phonebook Entries

Copy Phonebook allows you to transfer stored phonebook entries from one station to another without having to manually re-enter names and numbers. You can transfer one memory (phonebook entry) at a time, or all memory at once.

- 1) When the phone is in standby mode, press **phonebook**.
- 2) Press the **COPY** soft key.
- 3) Press  $\Delta$  **volume up/down** to select the station you want to transfer to and then press the **OK** soft key.
- 4) Press  $\Delta$  **volume up/down** to select `One Memory` or `All Memories:` and then press the **OK** soft key.

If you select `All Memory`, `Are you sure?` appears on the display screen.

Press  $\Delta$  **volume up/down** to select `Yes`, and then press the **OK** soft key.

If you select `One Memory`, select the phonebook entry you want to export and then press the **COPY** soft key.

- 5) Copying and name of the receiving station appear in the display. When the transfer is completed `Done!` appears on the display.

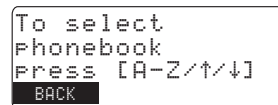
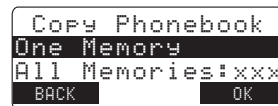
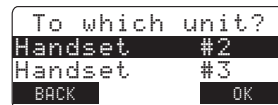



## Caller ID and CIDCW

When the telephone rings, the Caller ID feature displays the caller's name, phone number, date and time of call. With CIDCW (Caller ID on Call Waiting), you can see the Caller ID information of incoming calls even when you are on the phone. Additionally, you can dial a number stored in the Caller ID list or save data to your Phonebook locations.

### Important:

Each station can store up to 100 Caller ID records. Each station uses the same memory locations to store phonebook entries and Caller ID records. If the shared memory is already full, each time a Caller ID message is received, the phone overwrites the oldest Caller ID message to store the new message.

The date and time received	12/21 12:30PM
Caller's name	Jane Smith
Caller's phone number	214-555-1234
	BACK DELETE STORE

When the Caller ID message is received, the display shows the caller's phone number along with the date and time. The incoming call information is stored in the Caller ID record. If the Caller ID service includes the caller's name, the name will appear in the display (up to 15 characters).

### note

- If you answer a call before the Caller ID message is received (for example, before the second ring), the Caller ID message will not appear.
- When the call is received via a service provider that does not offer Caller ID service, the caller's phone number and name does not appear. (This includes some international calls.)
- When the call is via a private branch exchange (PBX), the caller's phone number and name may not appear.



The number of calls from the same Caller ID appears next to the received time. Once you view the new message, the number will be cleared and disappear.

You may receive any one of the following messages:

When a private name is received; `Private Name`

When a private number is received; `Private Number`

When an unknown name is received; `Unknown Name`

When an unknown number is received; `Unknown Number`

When invalid data is received; `Incomplete Data`



Data errors appear as "■."

## Viewing the Caller ID List

1) Press **cid** (or **call id**).

The summary screen appears. The screen shows the number of new messages and total messages.

2) To view the Caller ID messages in historical order, use

▲ **volume down** to scroll through the messages

starting with the most recent message, or ▲ **volume**

**up** to scroll through the messages starting with the oldest message.

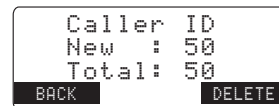

To jump to Caller ID messages beginning with a particular letter, press the number key that corresponds to the letter you want to jump to.



Once you view the Caller ID list alphabetically, you cannot switch back to historical order unless you exit and re-enter the operation.

- 3) To exit the Caller ID list, press the **BACK** soft key (on the base, you can also press the **exit** key).

### Deleting Information from the Caller ID List

- 1) When the phone is in standby mode, find the Caller ID information you want to delete. (see "Viewing the Caller ID List" on page 49).
- 2) Press the **DELETE** soft key. *Delete Caller ID* appears.
- 3) Press  $\Delta$  **volume up/down** to select *Yes*, and then press the **OK** soft key.
- 4) You will hear a confirmation tone.

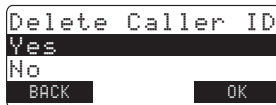

### Deleting all Caller ID names/numbers

- 1) When the phone is in standby mode, press **cid** (or **call id**).
- 2) Press the **DELETE** soft key. *Delete All?* appears.
- 3) Press  $\Delta$  **volume up/down** to choose *Yes*.
- 4) Press the **OK** soft key. You will hear a confirmation tone.

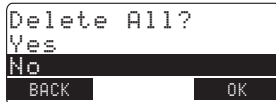
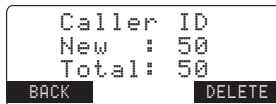

Once the Caller ID data has been deleted, the information cannot be retrieved.



- When a long distance call has been set, "1" appears in the display.
- You cannot make a call from the Caller ID list if your phone is connected to a private branch exchange (PBX).

## Calling a Party from the Caller ID List

### Standby mode

- 1) When the phone is in standby mode, select the Caller ID message (see "Viewing the Caller ID List" on page 49).
- 2) To have the phone dial a "1" before the displayed Caller ID number, press *\*/tone/*<. To have the phone dial the stored area code before the displayed Caller ID number, press *#/>*.
- 3) Press *talk/flash* or *speaker* on the handset or *speaker* on the base or pick up the corded handset. The displayed phone number dials automatically.



### Talk mode

- 1) Press *talk/flash* or *speaker* on the handset or *speaker* on the base or pick up the corded handset.
- 2) Select the Caller ID message you want to dial (see "Viewing the Caller ID List" on page 49).
- 3) Press the **DIAL** soft key. The displayed phone number will be dialed.

# Multi-Handset Features

The features in this section require a minimum of two handsets to operate. To add additional handsets to your system, see “Expanding Your Phone” on page 14.

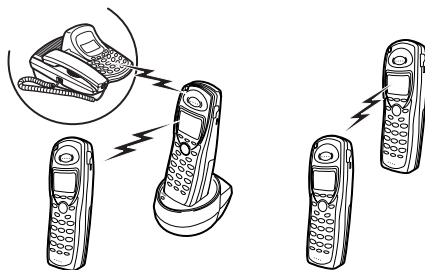

## Using DirectLink Mode

In DirectLink Mode, a pair of handsets can function as two-way radios. You can have up to five pairs of handsets in DirectLink Mode at a time. DirectLink Mode does not interfere with the main base's ability to make or receive telephone calls. You must set both handsets to DirectLink Mode to make a directlink call.

To use this feature, you must enter the handsets into DirectLink mode first.

- 1) Press the **MENU** soft key and select DirectLink Mode menu. To enter DirectLink mode press [ENTER] appears.
- 2) Press the **ENTER** soft key to enter DirectLink mode. You will hear a confirmation tone, and DirectLink Mode Complete appears.
- 3) To return to normal mode, press the **CANCEL** soft key and then the **OK** soft key, or return the handset to the cradle.

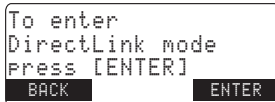

- Handsets can be in Direct Link mode while other handsets are in use.
- While a pair of handsets are in DirectLink mode, they cannot be used to make or receive calls. Other handsets can still make and receive calls.

## DirectLink call

- 1) When the phone is in DirectLink standby mode, press the **DirecLink** soft key (example of DirectLink from handset #1).
- 2) Select the handset to DirectLink with by pressing the number keys (**0-9**). Your handset will then page the other handset.
- 3) On the receiving handset, press **talk/flash**, the **ANSWER** soft key, or if Any Key Answer is on, press any number key, **\*/tone/<**, or **#/>**.
- 4) When you finish your conversation, press **end** or the **END** soft key on either handset. To cancel DirectLink mode and return to standby, return the handset to the cradle, or press the **CANCEL** soft key and then **OK** soft key.

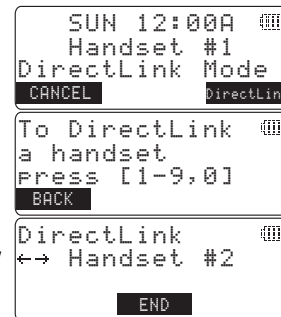

# Using the Room/Baby Monitor

This feature allows you to monitor sounds in another room. Place the base or a handset in the room you wish to monitor; it will function as a microphone. A second handset can be set to function as a remote speaker, allowing you to monitor sounds in the room.

## Using Room/Baby Monitor

- 1) Press the **MENU** soft key and select Room Monitor menu. To Room Mbnitor appears.
- 2) Select the handset or base you want to monitor by using **volume up/down**.
- 3) Press the **OK** soft key.  
RoomMbnitor appears, and you hear sounds in the room where the handset or the base is installed.
- 4) To turn off the Room Monitor, press the **END** soft key, or **end**.

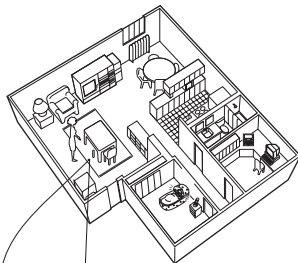

# Using the Intercom

You can use the intercom to talk to another station without using the phone line.

## Making an Intercom Page

### From a handset

- 1) With the phone in standby mode, press *intercom/hold*.
- 2) Use  $\Delta$ /*vol*/ $\wedge$  or  $\Delta$ /*vol*/ $\vee$  to select the station you want to page, and then press the **OK** soft key. If you select **ALL**, all other handsets and the base will be paged. An intercom tone sounds.

To intercom	
Handset	#2
Handset	#3
BACK	OK

### From the base

- 1) With the phone in standby mode, press *intercom/hold* on the base.
- 2) Use  $\Delta$ /*vol*/ $\wedge$  or  $\Delta$ /*vol*/ $\vee$  to select the station you want to page, and then press the **OK** soft key. If you select **ALL**, all other handsets will be paged. An intercom tone sounds.

If any of the following things occurs, the intercom operation will be canceled and the phone will return to standby:

- You press the CANCEL soft key  
The called station is busy or out of range
- You receive an outside call or intercom page while selecting the other station
- You do not select a station within thirty seconds
- The called station does not answer within one minute

## Answering an Intercom Page

When the intercom page tone sounds, the display will show the ID of the station that is paging.







When you accept the transferred call, the transferring station will be disconnected. The transferring station can rejoin the call by pressing **talk/flash** on a handset or **speaker** on the base.

### From the base

- 1) During a call, press **intercom/hold** on the base. The **CALL** will be put on hold.
- 2) Use **volume up/down** to select the handset you want to transfer the call to, and then press the **OK** soft key. If you select **ALL**, all handsets will be paged. To cancel the transfer, press **intercom/hold**, **speaker** or the **CANCEL** soft key.

### Answering a Call Transfer Page

When the page tone sounds, the display will show the ID of the station that is transferring the call.

#### To answer a page from a handset

- 1) Pick up the handset from the cradle. (If AutoTalk is enabled, the handset automatically answers when you pick it up.)
- 2) Press **talk/flash**, **intcom/hold**, or the **ANSWER** soft key.

#### To answer a page from the base

Pick up the corded base handset. To answer with the base speakerphone, press **intcom/hold**, **speaker**, or the **ANSWER** soft key.

### Accepting the call transfer

After answering the page, if you want to accept the call and speak to the outside caller, press **talk/flash** on the receiving handset or **speaker** on the base.

# Troubleshooting

If your phone is not performing to your expectations, please try these simple steps first. If these steps do not solve your problem, please call our Customer Service Hotline at 1-800-297-1023. (Mon - Fri 7 am to 7 pm, Sat/Sun 9 am to 5 pm, CST. The Customer Service Hotline is closed on holidays.)

## Getting Help

### **If you have trouble connecting to your VoIP Service**

Contact Packet8 customer service at **1-888-898-8733** or visit [www.packet8.net/support](http://www.packet8.net/support).

### **If you can questions about using your VoIP service features.**

Contact Packet8 customer service at **1-888-898-8733** or visit [www.packet8.net/support](http://www.packet8.net/support).

### **If you have questions on how to use your phone, add extra handsets, program the phonebook, etc.**

Contact Uniden customer service at 800-554-7331, Monday-Friday, 8 am to 5 pm, CST, or visit the Uniden website at [www.uniden.com](http://www.uniden.com) for documentation, FAQs, and troubleshooting tips.

## Installation Troubleshooting

### **Understanding the LED Indicators**

If you're having trouble with your UIP1868P, the LEDs on the front panel can help identify the problem. Figure 1 shows the location of the LEDs, and Table 1 lists the states of the LEDs and what they mean.

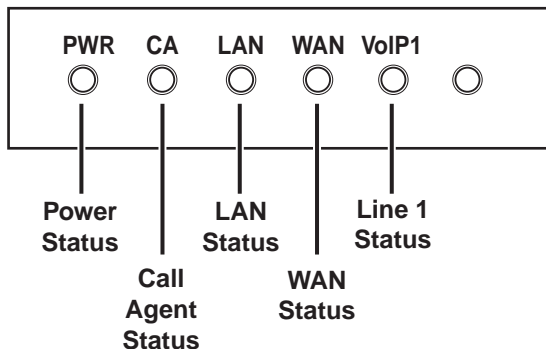

## LED Statuses and Their Meaning

LED	On	Off	Blinking
PWR (power)	The UIP1868P has power.	The UIP1868P has no power.	NA
CA (call agent)	The UIP1868P is signed on & recognized by the service provider's SIP Call Agent.	The UIP1868P is either not signed on or not recognized by the Call Agent.	NA
LAN	The UIP1868P detects a valid link on its LAN port.	The UIP1868P cannot detect a valid link.	The UIP1868P is receiving data on its LAN port.
WAN	The UIP1868P detects a valid link on its WAN port.	The UIP1868P cannot detect a valid link.	The UIP1868P is receiving data on its WAN port.
VoIP1	The telephone connected to this port is in use or off hook.	The connected phone is on hook (not in use).	Fast: There is an incoming call. Slow: There is a message waiting.



While the UIP1868P is downloading a firmware update or a new configuration file from your service provider, the LEDs will blink in sequence from left to right, beginning with the PWR LED.

## Resetting the UIP1868P

There are two ways to reset the UIP1868P: a *power cycle* restarts the unit, and a *hard reset* restores the unit to factory defaults.

### Power Cycle

Simply unplug the telephone UIP1868P and plug it in again. This restarts the UIP1868P and reloads the configuration file.

### Hard Reset

A hard reset restores the UIP1868P to factory defaults. All configuration changes will be lost.

**A:** Unplug the UIP1868P's AC adapter.

**B:** Insert a pin or bent-out paper clip into the **RESET** hole on the rear of the UIP1868P and push the reset button.

**C:** While holding the reset button pushed in, reconnect the UIP1868P's AC adapter.

**D:** Hold the reset button for ten seconds and then release it. This sets the UIP1868P main base back to factory defaults.

## Local Area Reset

Many problems can be solved by resetting all the local network equipment. To perform a local area reset, first power down all your local equipment: your modem, UIP1868P, switch or router, and computer. Then, restore power to the devices one at a time, starting with the one directly connected to the Internet and working your way down:

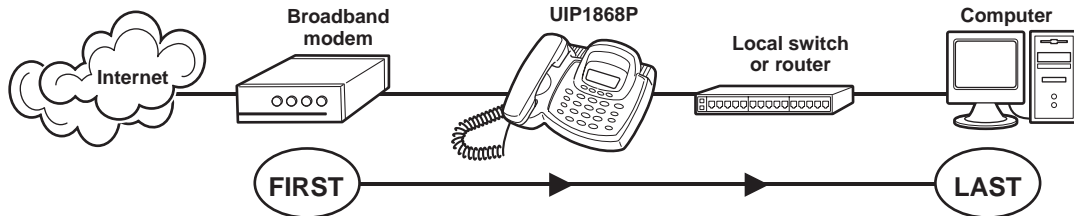

If a local area reset does not restore connectivity, see Common Issues below.

## Logging into the UIP1868P

If you need to configure the UIP1868P's router features or check settings while troubleshooting, you can log into the UIP1868P directly from your web browser.

**A:** Make sure your computer is directly connected to the UIP1868P's LAN port.

**B:** Open an Internet Explorer browser window.

**C:** In the address line of the browser, type **192.168.15.1** and press **ENTER**.

## Common Issues For Terminal Adapter Features

Scenario	Check to see if...	Then try...
Your UIP1868P is unable to connect to the Internet.	The PWR LED on the UIP1868P is off, or the power LED on your modem is off.	1) Checking the power connection to the UIP1868P, or your modem.
	The WAN LED on the UIP1868P is off and/or the LAN LED on your modem is off.	Making sure the cable between the UIP1868P and your modem is 1) Securely connected to the UIP1868P's WAN port. 2) Securely connected to your modem's LAN port 3) Free of any frays, loose connectors, or other visible defects
	The UIP1868P doesn't have a valid IP address. (Login to the UIP1868P and check the WAN Status screen.)	1) Making sure the UIP1868P is configured for DHCP or PPPoE (if your ISP uses DHCP or PPPoE). OR 1) Making sure the first three parts of the UIP1868P's IP address match you ISP's IP address and the fourth part is different 2) Making sure UIP1868P's subnet mask exactly matches the subnet mask of you ISP. OR 1) Making sure the UIP1868P's default gateway address is set to your ISP's IP address.

Scenario	Check to see if...	Then try...
Your computer is unable to connect to the Internet.	The LAN LED on the UIP1868P is off and/or the LINK LED on your computer's Ethernet card is off.	Making sure the cable between the UIP1868P and your computer is 1) Securely connected to the UIP1868P's LAN port. 2) Securely connected to your computer's Ethernet card 3) Free of any frays, loose connectors, or other visible defects
	Your computer doesn't have an IP address. (In most Windows systems, open a command prompt window and enter the command <i>ipconfig</i> .)	1) Making sure your computer is configured for DHCP. 2) Making sure the UIP1868P's DHCP Server is enabled.
	Your computer's IP address and subnet mask are on a different network than the UIP1868P's.	1) Making sure the first three parts of your computer's IP address match the UIP1868P's IP address and the fourth part is different 2) Making sure your computer's subnet mask exactly matches the subnet mask of the UIP1868P.
	The UIP1868P is not the default gateway for your computer.	1) Making sure your computer's default gateway address is set to the UIP1868P's IP address.
Your UIP1868P corded handset has no dial tone.	The CA (call agent) LED is off.	1) Resetting the UIP1868P. 2) Contacting Packt8 to verify the necessary SIP configuration settings.
	The CA (call agent) LED is on.	1) Plugging a standard analog phone into the UIP1868P's VoIP1 port. If this works, your UIP1868P may be damaged. Contact Uniden customer service.

## For Telephone Features

Symptom	Suggestion
The <b>charge</b> LED won't illuminate when the handset is placed in the cradle.	<ul style="list-style-type: none"> <li>• Make sure the AC adapter is plugged into the charger and wall outlet.</li> <li>• Make sure the handset is properly seated in the cradle.</li> <li>• Make sure the charging contacts on the handset are clean.</li> </ul>
The audio sounds weak.	<ul style="list-style-type: none"> <li>• Move the handset and/or base away from metal objects or appliances and try again.</li> <li>• Make sure that you are not too far from the base.</li> </ul>



Symptom	Suggestion
The cordless handset can't make or receive calls.	<ul style="list-style-type: none"> <li>• Make sure that you are not too far from the base.</li> <li>• Make sure the line is not in use. If an outside call is already using a line, you cannot use that line to make another outside call.</li> <li>• De-register the handset (see “De-register the Handset” on page 16) and register the handset (see “Registering Expansion Handsets” on page 15).</li> </ul>
The handset doesn't ring or receive a page.	<ul style="list-style-type: none"> <li>• Make sure that you are not too far from the base.</li> <li>• Charge the batteries in the handset for 15-20 hours by placing the handset on the charging cradle.</li> <li>• De-register the handset (see “De-register the Handset” on page 16) and register the handset (see “Registering Expansion Handsets” on page 15).</li> </ul>
Severe noise interference.	<ul style="list-style-type: none"> <li>• Keep the handset away from microwave ovens, computers, remote control toys, wireless microphones, alarm systems, intercoms, room monitors, fluorescent lights, and electrical appliances.</li> <li>• Move to another location or turn off the source of interference.</li> </ul>
Caller ID does not display.	<ul style="list-style-type: none"> <li>• The handset was picked up before the second ring.</li> <li>• The call was placed through a switchboard.</li> <li>• Contact your service provider to verify the Caller ID settings.</li> </ul>
You cannot register the handset at the base.	<ul style="list-style-type: none"> <li>• Charge the battery pack for 15-20 hours.</li> <li>• De-register the handset (see “De-register the Handset” on page 16) and register the handset (see “Registering Expansion Handsets” on page 15).</li> </ul>
The handset doesn't communicate with other handsets.	<ul style="list-style-type: none"> <li>• De-register the handset (see “De-register the Handset” on page 16) and register the handset (see “Registering Expansion Handsets” on page 15).</li> <li>• Make sure that you have registered all handsets.</li> </ul>
An extra handset can't join the conversation.	<ul style="list-style-type: none"> <li>• Make sure there are not two handsets already using the conference feature.</li> <li>• Make sure that another station is not in privacy mode.</li> </ul>
The base can't join the conversation	<ul style="list-style-type: none"> <li>• Make sure that another station is not in privacy mode.</li> </ul>
Room Monitor feature does not work.	<ul style="list-style-type: none"> <li>• Make sure to place the handset(s) within the range of the base.</li> </ul>

## Note on Power Sources

### **Battery replacement and handling**

When the operating time becomes short, even after a battery is recharged, please replace the battery. With normal usage, your battery should last about one year. Please contact your place of purchase or the Uniden Parts Department for a replacement battery.

### **Warning**

To avoid the risk of personal injury or property damage from fire or electrical shock, only use the Uniden battery model and Uniden adapter model specifically designated for this product.

#### Caution

- Use only the specified Uniden battery pack (BT-446).
- Do not remove the batteries from the handset to charge them.
- Never throw the battery into a fire, disassemble them, or heat them.
- Do not remove or damage the battery casing.



## General Information

The phone complies with FCC Parts 15 Operating temperature:  
0 °C to +50 °C (+32 °F to +122 °F)

### AC Adapter Information

AC Adapter part number: AD-1002 for the base	AD-0005 for the charger
Input Voltage: 120 AC 60Hz	120V AC 60Hz
Output Voltage: 9, 12V DC 350, 1000mA	9V DC 210mA

### Battery Information

Battery part number: BT-446  
Capacity: 800mAh, 3.6V



- To avoid damage to the phone use only Uniden AD-1002 and BT-446, and AD-0005 with your phone.
- If the handset is left off of the base, the actual Talk mode duration will be reduced respective to the amount of time the handset is off the base.

Recharge your phone on a regular basis by returning the handset to the charger after each phone call. When the operating time becomes short even after the battery is recharged, please replace the battery. With normal usage, the battery should last about one year.

A replacement Uniden adapter or battery may be purchased by contacting the Uniden Parts Department (see back page).

Specifications, features, and availability of optional accessories are all subject to change without prior notice.

# Liquid Damage

Moisture and liquid can damage your cordless phone. In case of accidental submersion, please read the following steps.

Case	Action
If the handset or base is exposed to moisture or liquid, but it only affects the exterior plastic housing.	Wipe off the liquid, and use as normal.
If moisture or liquid has entered the plastic-housing (i.e. liquid can be heard in the phone or liquid has entered the handset battery compartment or vent openings on the base).	<p><b>Handset:</b></p> <ol style="list-style-type: none"> <li>1) Remove the battery cover and leave it off for ventilation.</li> <li>2) Remove the battery pack by disconnecting.</li> <li>3) Leave the battery cover off and the battery pack disconnected for at least 3 days.</li> <li>4) Once the handset is completely dry, reconnect the battery pack and the battery cover.</li> <li>5) Recharge the handset's battery pack for 20 hours before using again.</li> </ol> <p><b>Base:</b></p> <ol style="list-style-type: none"> <li>1) Disconnect the AC adapter from the base unit, cutting off electrical power.</li> <li>2) Disconnect the telephone cord from the base unit.</li> <li>3) Let dry for at least 3 days.</li> </ol> <p><b>IMPORTANT:</b> You must <b>unplug the telephone line while recharging the battery pack</b> to avoid charge interruption.</p> <p><b>CAUTION:</b> DO NOT use a microwave oven to speed up the drying process. This will cause permanent damage to the handset, base and the microwave oven. After following these steps, if your cordless telephone does not work, please contact Customer Service (see back page).</p>

## Precautions!

Before you read anything else, please observe the following:

### Warning!

Uniden America Corporation DOES NOT represent this unit to be waterproof. To reduce the risk of fire, electrical shock, or damage to the unit, DO NOT expose this unit to rain or moisture.

### Rechargeable Nickel-Metal-Hydride Battery Warning

- This equipment contains a rechargeable Nickel-Metal-Hydride battery.
- Nickel is a chemical known to state of California to cause cancer.
- The rechargeable Nickel-Metal-Hydride battery contained in this equipment may explode if disposed of in a fire.
- Do not short-circuit the battery.
- Do not charge the rechargeable Nickel-Metal-Hydride battery used in this equipment in any charger other than the one designed to charge this battery as specified in the owner's manual. Using another charger may damage the battery or cause the battery to explode.

### Rechargeable Nickel-Metal-Hydride Batteries Must Be Recycled or Disposed of Properly



The exclamation point within an equilateral triangle is intended to alert the user to the presence of important operating and maintenance (servicing) instructions in the literature accompanying the appliance.

Uniden works to reduce lead content in our PVC coated cords in our products and accessories.

### Warning!

The cords on this product and/or accessories contain lead, a chemical known to the State of California to cause birth defects or other reproductive harm. **Wash hands after handling.**

## Important Safety Instructions

When using your telephone equipment, basic safety precautions should always be followed to reduce the risk of fire, electric shock and injury to persons, including the following:

1. Do not use this product near water, for example, near a bathtub, wash bowl, kitchen sink or laundry tub, in a wet basement or near a swimming pool.
2. Avoid using a telephone (other than a cordless type) during an electrical storm. There may be a remote risk of electric shock from lightning.
3. Do not use the telephone to report a gas leak in the vicinity of the leak.
4. Use only the power cord and batteries indicated in this manual. Do not dispose of batteries in a fire. They may explode. Check with local codes for possible special disposal instructions.

### SAVE THESE INSTRUCTIONS

CAUTION: Risk of explosion if battery is replaced by an incorrect type. Dispose of used batteries according to the instructions.

## The FCC Wants You To Know

Should you experience trouble with this equipment, please contact Uniden customer service at 800-297-1023.

Changes or modifications to this product not expressly approved by Uniden, or operation of this product in any way other than as detailed by the owner's manual, could void your authority to operate this product. This device complies with part 15 of the FCC rules. Operation is subject to the following two conditions: (1) This device may not cause harmful interference, and (2) This device must accept any interference received, including interference that may cause undesired operation. Privacy of communications may not be ensured when using this phone. To insure the safety of users, the FCC has established criteria for the amount of radio frequency energy various products may produce depending on their intended usage. This product has been tested and found to comply with the FCC's exposure criteria. For body worn operation, the FCC RF exposure guidelines were also met when used with the Uniden accessories supplied or designed for this product. Use of other accessories may not ensure compliance with FCC RF exposure guidelines and should be avoided.

## One Year Limited Warranty

Important: Evidence of original purchase is required for warranty service. WARRANTOR: UNIDEN AMERICA CORPORATION ("Uniden") ELEMENTS OF WARRANTY: Uniden warrants, for one year, to the original retail owner, this Uniden Product to be free from defects in materials and craftsmanship with only the limitations or exclusions set out below.

**WARRANTY DURATION:** This warranty to the original user shall terminate and be of no further effect 12 months after the date of original retail sale. The warranty is invalid if the Product is (A) damaged or not maintained as reasonable or necessary, (B) modified, altered, or used as part of any conversion kits, subassemblies, or any configurations not sold by Uniden, (C) improperly installed, (D) serviced or repaired by someone other than an authorized Uniden service center for a defect or malfunction covered by this warranty, (E) used in any conjunction with equipment or parts or as part of any system not manufactured by Uniden, or (F) installed or programmed by anyone other than as detailed by the owner's manual for this product.

**STATEMENT OF REMEDY:** In the event that the product does not conform to this warranty at any time while this warranty is in effect, warrantor will either, at its option, repair or replace the defective unit and return it to you without charge for parts, service, or any other cost (except shipping and handling) incurred by warrantor or its representatives in connection with the performance of this warranty. Warrantor, at its option, may replace the unit with a new or refurbished unit. THE LIMITED WARRANTY SET FORTH ABOVE IS THE SOLE AND ENTIRE WARRANTY PERTAINING TO THE PRODUCT AND IS IN LIEU OF AND EXCLUDES ALL OTHER WARRANTIES OF ANY NATURE WHATSOEVER, WHETHER EXPRESS, IMPLIED OR ARISING BY OPERATION OF LAW, INCLUDING, BUT NOT LIMITED TO ANY IMPLIED WARRANTIES OF MERCHANTABILITY OR FITNESS FOR A PARTICULAR PURPOSE. THIS WARRANTY DOES NOT COVER OR PROVIDE FOR THE REIMBURSEMENT OR PAYMENT OF INCIDENTAL OR CONSEQUENTIAL DAMAGES. Some states do not allow this exclusion or limitation of incidental or consequential damages so the above limitation or exclusion may not apply to you.

**LEGAL REMEDIES:** This warranty gives you specific legal rights, and you may also have other rights which vary from state to state. This warranty is void outside the United States of America and Canada. **PROCEDURE FOR OBTAINING PERFORMANCE OF WARRANTY:** If, after following the instructions in the owner's manual you are certain that the Product is defective, pack the Product carefully (preferably in its original packaging). Disconnect the battery from the Product and separately secure the battery in its own separate packaging within the shipping carton. The Product should include all parts and accessories originally packaged with the Product. Include evidence of original purchase and a note describing the defect that has caused you to return it. The Product should be shipped freight prepaid, by traceable means, to warrantor at:

Uniden America Service  
4700 Amon Carter Blvd.  
Fort Worth, TX 76155

# I.C. Notice

## **RADIO EQUIPMENT**

The term "IC:" before the radio certification number only signifies that Industry Canada technical specifications were met.

Operation is subject to the following two conditions: (1) this device may not cause interference, and (2) this device must accept any interference, including interference that may cause undesired operation of the device. "Privacy of communications may not be ensured when using this telephone".

# Index

## A

Animation screen	26
Anykey Answer	24
Area Code	29
AutoTalk	23

## B

Banner	24
Battery	
Preparing	12
Replacement and handling	65
Beltclip	17

## C

Call transfer feature	56
Caller ID	
Caller ID services	48
Calling	51
CIDCW	48
Deleting	50
Setting	29
Storing	43
Viewing	49
Clock	28
Conferencing	37
Contrast	25
Copying phonebook	47

## D

De-register the handset	16
Distinctive ringer	23

## E

Earpiece volume	34
-----------------	----

## G

General information	67
---------------------	----

## H

Headset installation	17
Hold	32

## I

I.C. notice	70
Intercom	55

## K

Key touch tone	26
----------------	----

## L

Language	25
Liquid damage	68

## M

Making a call	30
Mute	36

## P

Phonebook	
Making calls	45
Viewing	44
Precautions	69
Privacy Mode	37

## R

Receiving a call	31
Redialing a call	33
Ringer	
Adjusting	34
Do not disturb	35
Mute	35
Tone	22
Room/baby monitor	54

## S

Setting up	
------------	--

Handset	12, 22
Menu options	21

Soft Key	19
Speed dialing	45

## T

Transferring a call	56
---------------------	----

## V

Voice Mail Access	39
-------------------	----

## W

Warranty	69
----------	----



# Main Menu Flow Chart

## •From standby mode

### •Base



MENU  
→



### •Handset



MENU  
→



∨



∨



Enter

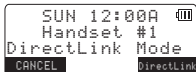

∧

or

∨

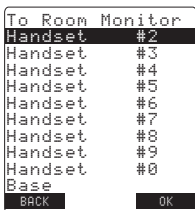

∧

or

∨

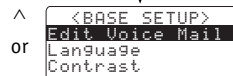

∧

or

∨

OK

•Base

Room Monitor  
v Base Setup  
→ Global Setup  
BACK OK

•Handset

Room Monitor  
v Handset Setup  
→ Global Setup  
BACK OK

↓ OK

^ <GLOBAL SETUP  
Day & Time  
or CIDCW  
Area Code  
v Dial Mode  
Voice  
BACK

To  
our v

**Help for**  
If you need  
features of th

May be covered

4,797,916	5,381,460	
5,574,727	5,581,598	5,794,281
5,671,248	5,696,471	5,794,281
5,768,345	5,787,356	5,794,281
5,893,034	5,912,968	5,915,221
5,987,330	6,044,281	6,070,082
6,671,315	6,714,630	6,782,098

Other patents pending.

FOR  
ACCESSORIES,  
GO ONLINE @  
WWW.UNIDEN.COM

**REGISTER ONLINE TODAY!**

**THANK YOU FOR BUYING A UNIDEN PRODUCT.**

A World Without Wires | **Uniden**<sup>®</sup>